

# GR-XL Series

35-100 TON CAPACITY

**ROUGH  
TERRAIN  
CRANE**







## GR-350XL

Crane capacity: 35 tons (31.8 metric tons)  
4-section boom: 101.7 ft (31.0 m)  
2-staged jib: 23.6 ft / 42 ft (7.2 m / 12.8 m)

## GR-550XL

Crane capacity: 55 tons (50.0 metric tons)  
4-section boom: 113.9 ft (34.7 m)  
2-staged bi-fold jib: 28.9 ft / 50 ft (8.8 m / 15.2 m)

# New Generation of Cranes



## NEW FEATURES

HELLO-NET System	03
The Environmentally Friendly Features	04
Fuel Monitoring System	05
Eco Mode System	
Positive Control System	

## Crane

The Ultimate boom for rough terrain crane	07
Assist cylinder for jib	08
Jib installation	
Two winches with cable follower	
Two telescoping modes I & II	
New crane structure	
Bi-fold jib	09
Load moment indicator [AML-C]	11
Outrigger asymmetric extension width control	12
Operator comfort	13
Seat adjustment	14
Adjustment of control lever stand	
Wider steps and hand rails	

## Carrier

New carrier frame	15
High performance engine	
Dashboard indicator and warning symbols	16
Smooth transmission	
Fastest travel speed	17
Comfortable suspension	
Axle	
Brake systems	
4 steering modes	
Self-removable counterweight	

WORKING RANGE & DIMENSIONS	19
----------------------------	----

SPECIFICATIONS	21
----------------	----



# GR-750XL

Crane capacity: 75 tons (68.0 metric tons)  
 5-section boom: 141.1 ft (43.0 m)  
 2-staged bi-fold jib: 33.2 ft / 58.1 ft (10.1 m / 17.7 m)

# GR-1000XL

Crane capacity: 100 tons (90.7 metric tons)  
 5-section boom: 154.2 ft (47.0 m)  
 2-staged bi-fold jib: 33.2 ft / 58.1 ft (10.1 m / 17.7 m)

At Tadano, crane development is our number one priority. Our goal is to provide the safest, most innovative and reliable cranes in the industry that are able to handle all aspects of your job. Tadano has a rough terrain crane solution for even the most hard to reach projects. Our cranes adapt to the changing needs of your business and at the same time reduce environmental impact. Experience the new generation of cranes!

# NEW FEATURES

## HELLO-NET System

TADANO supports your crane management via the Internet, providing information about operational status, position and maintenance.

HELLO-NET Owner's Site enables sharing of machine data between TADANO Group and machine owners. We offer you advanced customer support.

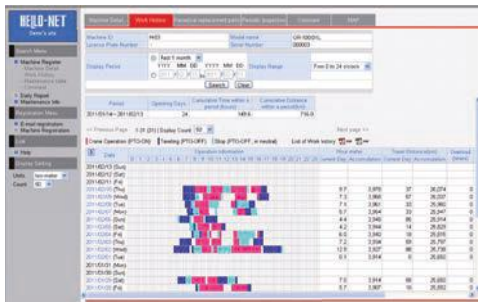
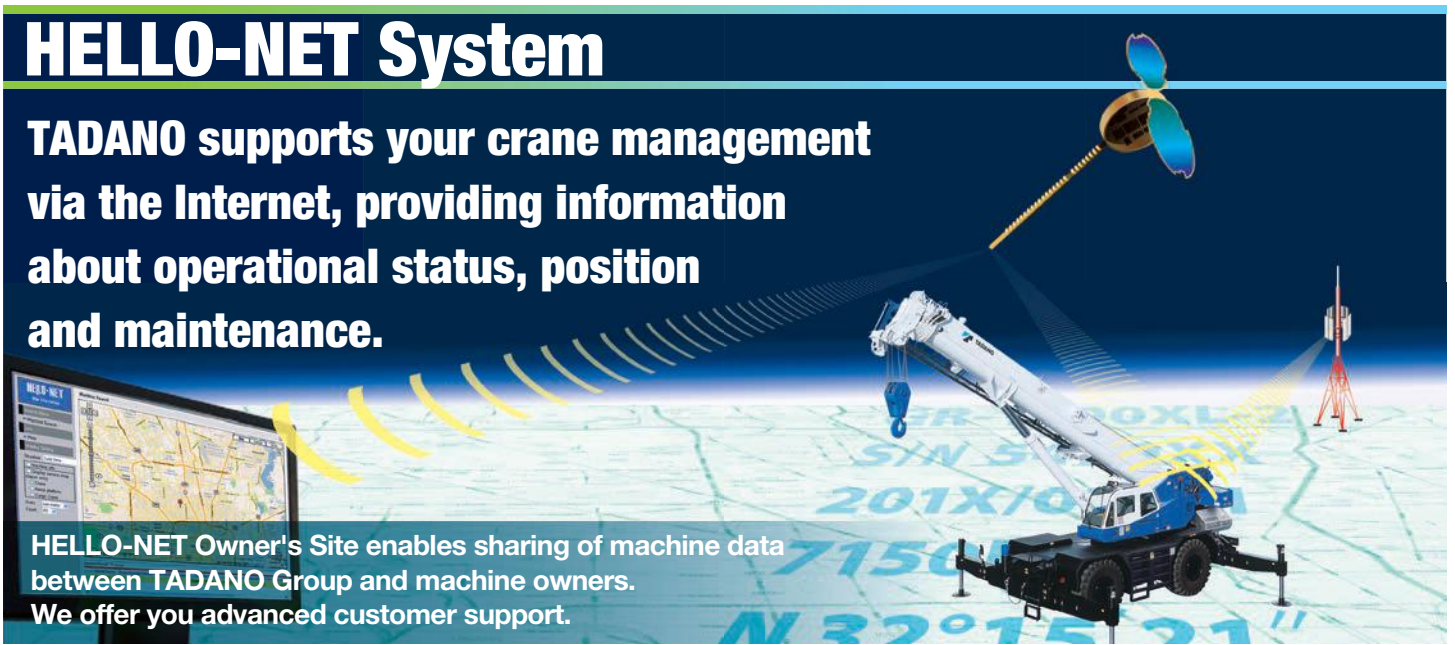

### Monitoring machine information from your computer

#### 1. Work History

HELLO-NET Owner's Site can display the day-to-day operational status, mileage and remaining fuel for each machine that is equipped with a communication terminal. In addition, you can view a list displaying the number of hours of operation and the mileage of all your machines for any specified month.

#### 2. Machine Position Data

Using HELLO-NET Owner's Site, you can check a machine's latest position (up until previous day) on a map. Two types of position data, listed below, are transmitted automatically from your machine once every day. Work Site: The location where the machine's PTO has been activated (for one hour or more). Position at Day's End: The final location from which GPS was able to receive data on a given day.

#### 3. Maintenance Information

You can check the maintenance timetable of your machines for periodical replacement parts and inspection schedule. HELLO-NET supports the maintenance of your machine.

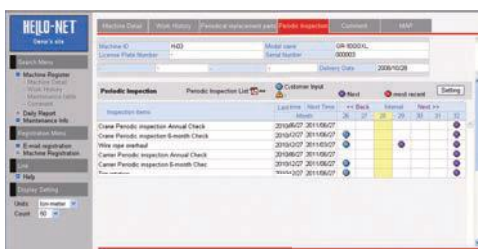

HELLO-NET Telematics - Available in the U.S. and Canada, other countries may vary. Contact your distributor or [sales@tadano-cranes.com](mailto:sales@tadano-cranes.com) for details.



# The Environmentally Friendly Features

Designed to minimize environmental impact.



TADANO's rough terrain cranes are equipped with Fuel Monitoring System, Eco Mode System and Positive Control Systems that substantially reduce fuel consumption and CO<sub>2</sub> emissions.

Fuel consumption indicator



## Introducing Fuel Monitoring System

The Fuel Monitoring System, displayed on the AML-C screen, monitors fuel consumption rates during crane operations, idling, and while traveling, allowing the operator to optimize fuel efficiency, reduce CO<sub>2</sub> emissions and noise level.



## Two devices reduce fuel consumption

TADANO aims to reduce fuel consumption by its two newly developed technologies, the Eco Mode System and the Positive Control System. Consideration was given to the length of actual operating hours as well as non-operating time (when the crane is in a state of idling). In this relation, the average ratio between the operating hours and the non-operating time is 40/60% according to the results of our investigation. This understanding helped us to successfully achieve our objectives.



**Eco Mode System** - reduces fuel consumption by approximately 40% while the crane is being operated.



**Positive Control System** - reduces fuel consumption by approximately 60% when the crane is in a state of idling.

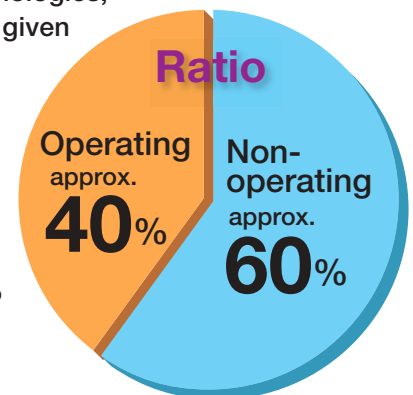

# Fuel Monitoring System

The Fuel Monitoring System constantly monitors fuel consumption on the AML screen. Checking this monitor enables you to prevent wasteful fuel consumption from unnecessary acceleration and idling.

## Working



**Display panel**

During crane operation

- Current fuel consumption
- Average fuel consumption: **AVG 0.4 hour/G**

While idling

- Fuel consumption while idling: **N 0.1 G 10min**

**Numeric display**

	G(N)	G(D)	h/G
17:15	1.2	0.9	1.5
06.16 20:10	13.1	54.4	0.7
06.09 16:23	14.3	30.5	1.0
06.03 17:19	11.4	36.2	0.8
05.27 18:23	12.8	52.2	0.8
05.20 19:35	16.4		

**Bargraph display**

The display changes every time you push the display change key.

## Driving

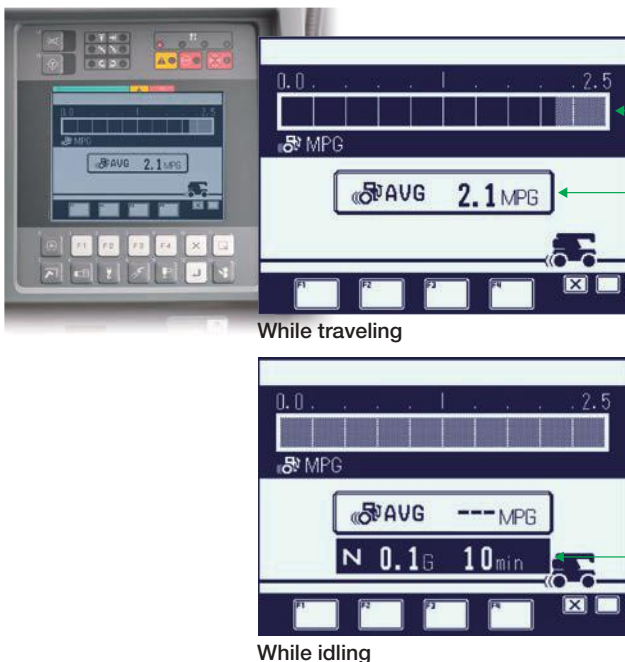

**While traveling**

- Current fuel consumption
- Average fuel consumption: **AVG 2.1 MPG**

**While idling**

- Fuel consumption while idling: **N 0.1 G 10min**

**Numeric display**

	G(N)	G(D)	h/G
17:15	1.1	7.6	2.4
06.16 20:10	5.4	31.4	2.6
06.09 16:23	5.2	52.8	1.4
06.03 17:19	10.3	51.8	1.9
05.27 18:23	3.9	37.4	1.9
05.20 19:35	5.9	36.7	1.6

**Bargraph display**

The display changes every time you push the display change key.

## Eco Mode System

The Eco Mode System controls the maximum engine speed at the time of crane operation. To prevent an unnecessary rise in engine speed when there is excessive acceleration, the system enables fuel consumption and CO<sub>2</sub> emissions to decrease by Max. 22% with Eco mode I, and Max. 30% with Eco mode II, and the noise level is reduced.

### Fuel consumption CO<sub>2</sub> emissions



Eco mode 1

Eco mode 2

\* The above figures differ according to the type of crane used and its operating conditions.

### Screen setting the eco mode to be selected

## Positive Control System

The Positive Control System effectively controls the quantity of hydraulic pump discharge during crane operation in response to the amount of movement applied by the operating control lever.

When the crane is in a state of idling, the Positive Control System keeps the quantity of hydraulic pump discharge to a minimum, reducing fuel consumption and CO<sub>2</sub> emissions by up to 20%.

Fuel consumption  
and CO<sub>2</sub> emissions ratio compared  
with the conventional system



\* Comparison made when a crane is not being operated

\* The above figures differ according to the type of crane used and its operating conditions.





# Crane



## New Design

### The Ultimate boom for rough terrain crane ( GR-1000XL, GR-750XL, GR-550XL )

The rounded boom is made of high tensile steel, which allows for decreased boom weight and increased boom strength. The high performance AML-C comes standard and aids the operator in maintaining a safe operation.

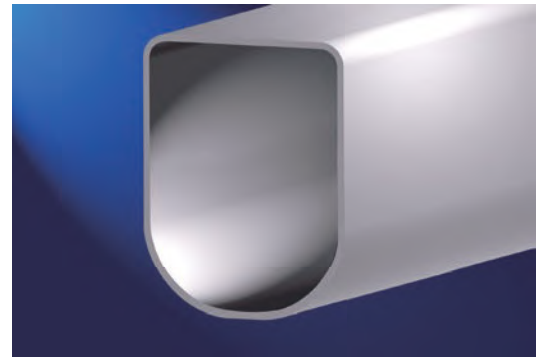

GR-350XL



### The hexagonal boom





### Assist cylinder for jib

( GR-1000XL, GR-750XL, GR-550XL )

When mounting and stowing the jib, the assist hydraulic cylinders are used resulting in increased work efficiency and safety.

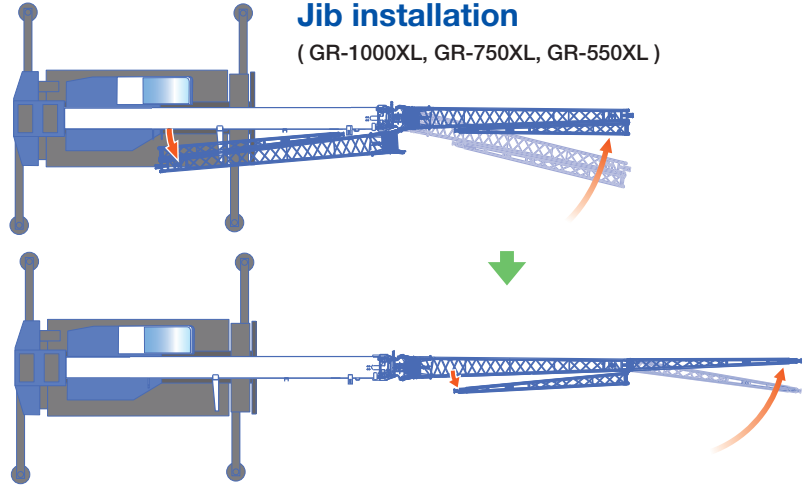

### Jib installation

( GR-1000XL, GR-750XL, GR-550XL )

### Two winches with cable follower

Both the main winch and the auxiliary winch have powerful line pull and operate at high speeds thus enhancing work efficiency.

\*Maximum permissible line pull may be affected by wire rope strength.

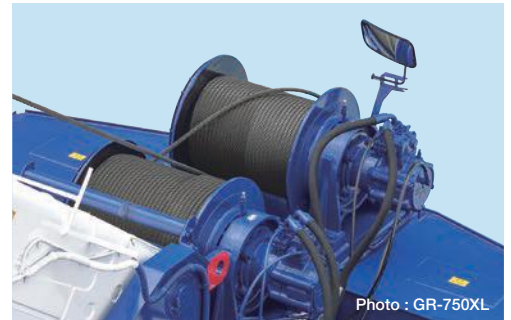

Photo : GR-750XL



### Mode I

Mode I is extension of 2nd section only. Then follows the synchronized extension of 3rd, 4th and 5th sections.

### Two telescoping modes I & II

( GR-1000XL, GR-750XL )

The operator has enhanced capabilities with two boom telescoping options whichever suits the lift needs.



### Mode II

Mode II is synchronized extension of 3rd, 4th and 5th sections. Then 2nd section extends independently.

### New crane structure ( GR-1000XL, GR-750XL, GR-550XL )

During development of the structural shape of the crane,

\*FEM analysis was applied to achieve a design tailored for optimal operation.

The slewing frames' structure ensures a highly rigid, compact style that is well suited for the overall planned design of the crane.

Continuing the TADANO tradition of excellence and innovation.

\*FEM: Finite Element Method

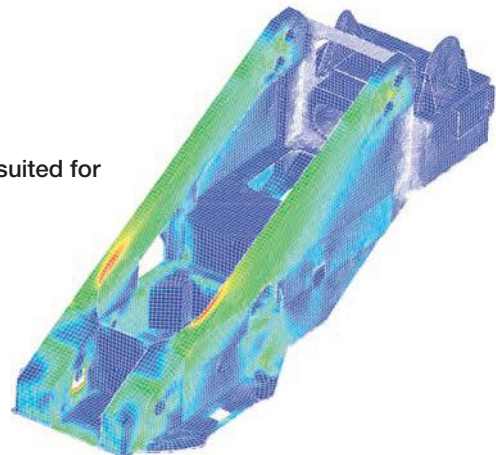

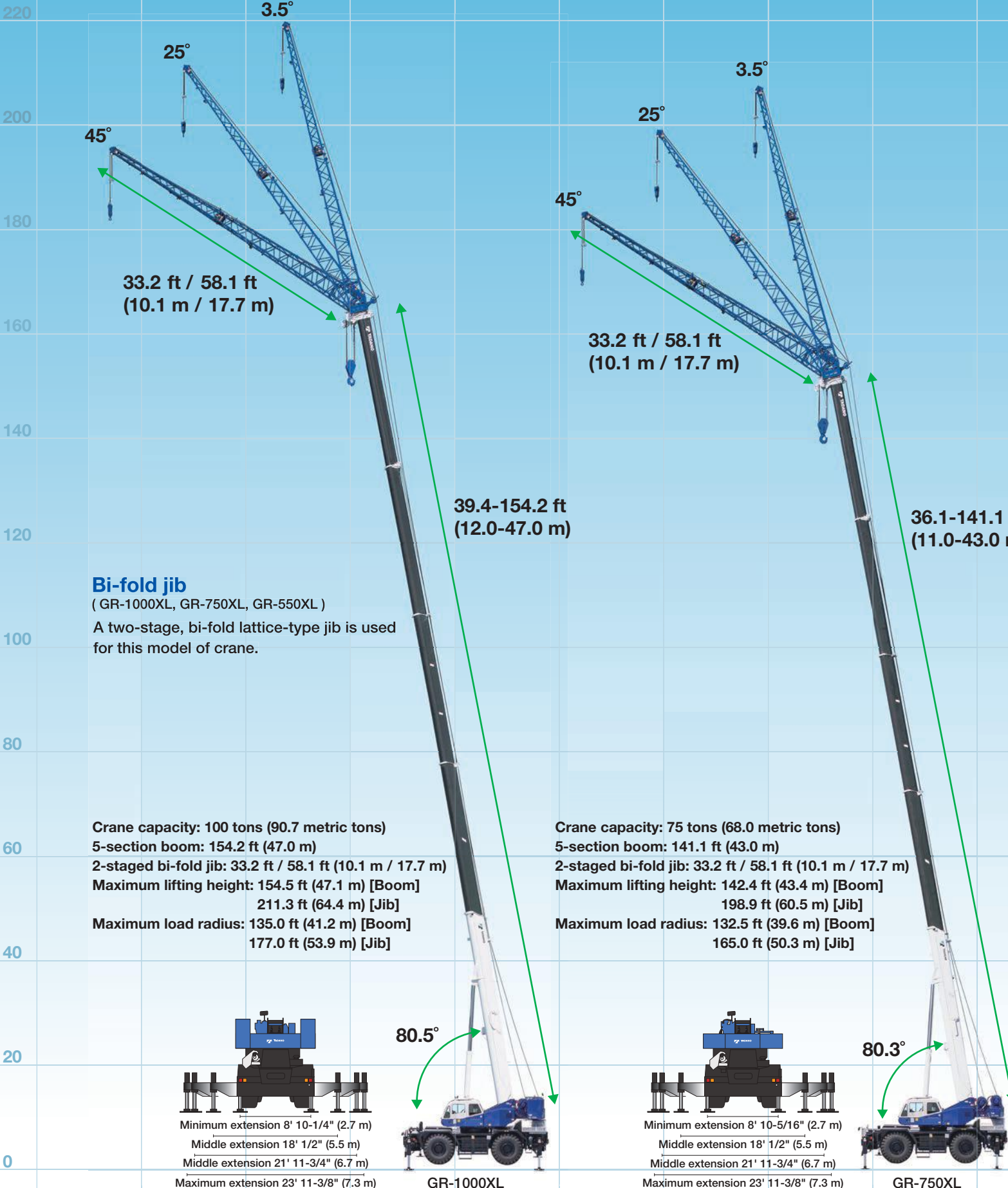

33.2 ft / 58.1 ft  
(10.1 m / 17.7 m)

33.2 ft / 58.1 ft  
(10.1 m / 17.7 m)

39.4-154.2 ft  
(12.0-47.0 m)

36.1-141.1  
(11.0-43.0 m)

**Bi-fold jib**

(GR-1000XL, GR-750XL, GR-550XL)

A two-stage, bi-fold lattice-type jib is used for this model of crane.

Crane capacity: 100 tons (90.7 metric tons)  
 5-section boom: 154.2 ft (47.0 m)  
 2-staged bi-fold jib: 33.2 ft / 58.1 ft (10.1 m / 17.7 m)  
 Maximum lifting height: 154.5 ft (47.1 m) [Boom]  
 211.3 ft (64.4 m) [Jib]  
 Maximum load radius: 135.0 ft (41.2 m) [Boom]  
 177.0 ft (53.9 m) [Jib]

Crane capacity: 75 tons (68.0 metric tons)  
 5-section boom: 141.1 ft (43.0 m)  
 2-staged bi-fold jib: 33.2 ft / 58.1 ft (10.1 m / 17.7 m)  
 Maximum lifting height: 142.4 ft (43.4 m) [Boom]  
 198.9 ft (60.5 m) [Jib]  
 Maximum load radius: 132.5 ft (39.6 m) [Boom]  
 165.0 ft (50.3 m) [Jib]

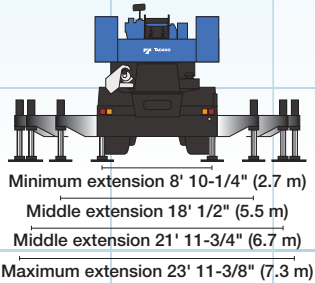

GR-1000XL

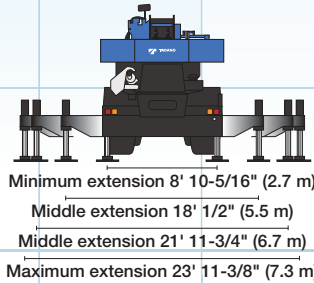

GR-750XL



220

200

180

160

140

120

100

80

60

40

20

0

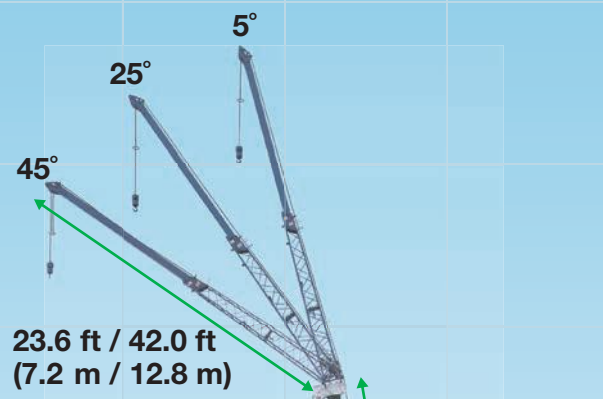
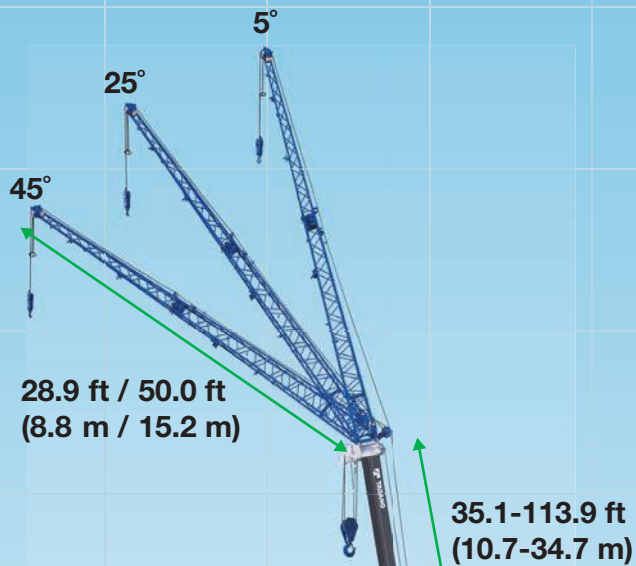

**Jib** ( GR-350XL )

Box type top section telescopes from lattice type base section which stows alongside base boom section.

Crane capacity: 55 tons (50.0 metric tons)  
 4-section boom: 113.9 ft (34.7 m)  
 2-staged bi-fold jib: 28.9 ft / 50 ft (8.8 m / 15.2 m)  
 Maximum lifting height: 114.5 ft (34.9 m) [Boom]  
 164.3 ft (50.1 m) [Jib]  
 Maximum load radius: 105.4 ft (32.0 m) [Boom]  
 138.5 ft (42.2 m) [Jib]

Crane capacity: 35 tons (31.8 metric tons)  
 4-section boom: 101.7 ft (31.0 m)  
 2-staged jib: 23.6 ft / 42 ft (7.2 m / 12.8 m)  
 Maximum lifting height: 104.3 ft (31.8 m) [Boom]  
 144.3 ft (44.0 m) [Jib]  
 Maximum load radius: 93.6 ft (27.4 m) [Boom]  
 122.0 ft (37.2 m) [Jib]

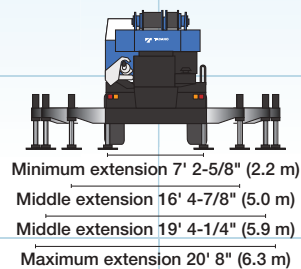
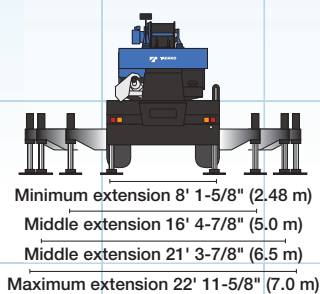

## Load moment indicator [AML-C]

Tadano's AML-C is easy to use, innovative in design, displays important information to the operator and enables the operator to preset a custom working environment. For example, the AML-C shows the boom angle, boom length, load radius, operating pressure of the elevating cylinder, the extension width of the outriggers, slewing position, rated lifting capacity and present hook load. These features allow the AML-C to move seamlessly through all lifting operations without having to change configurations or input new codes to make the lift. The AML-C safety features provide both audible and visual warnings. When an operation approaches the load limit Tadano's slow stop function engages to avoid shock loads.

## Drum rotation indicator

To let the operator know when the winch is rotating, the drum rotation indicator on the AML beeps and flashes sequentially. The moving distance of the hook block per one flash of the indicator is approximately 7.9 in. to 11.8 in. (20 cm to 30 cm).

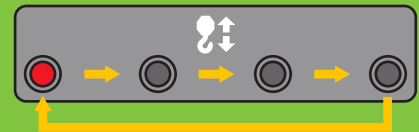

## AML display symbols

Labels for the AML display symbols:

- Moment load ratio
- Jib length
- Jib lift
- Number of part lines
- Boom telescoping mode
- Boom length
- Boom lift
- Winch selection
- Outrigger status
- Eco mode
- Fuel consumption
- Load radius
- Boom angle
- Jib offset angle
- Hook load
- Rated lifting capacity
- Control selector switch
- Slewing position
- Front position

GR-1000XL



AML lamp



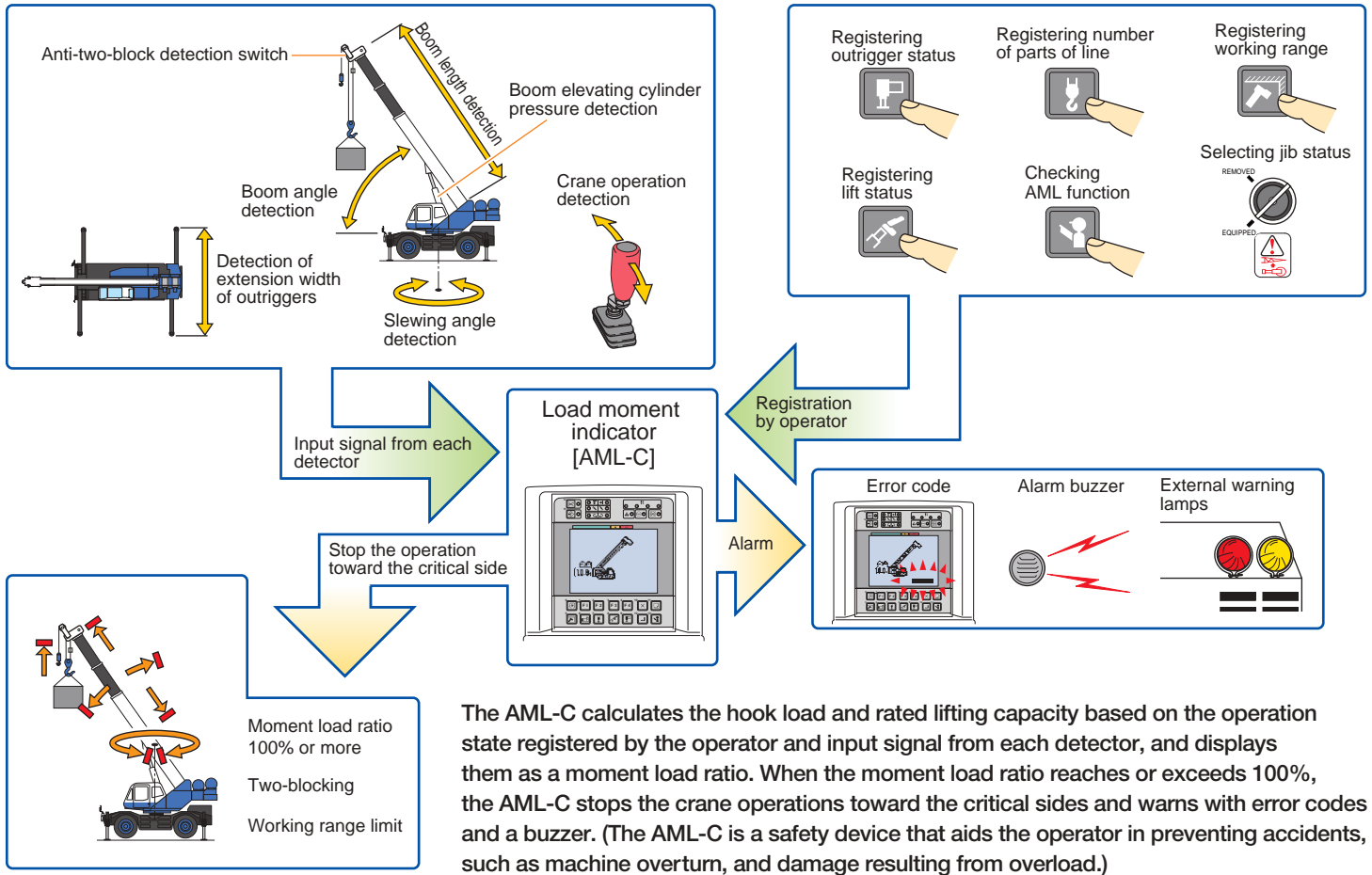

# Safety First!

## Outrigger asymmetric extension width control

When operating the crane with the asymmetric outriggers extended, the AML-C detects the extension width of all of the Crane's outriggers (front, rear, left and right) to measure maximum work capacity in each area.

When slewing the boom from the longer outrigger area to the shorter outrigger area, the AML-C detects the motion and displays the maximum capacity according to the extension width of each of the outriggers, and brings the motion to a slow stop before it reaches the maximum capacity. Therefore, even in the case of operator error, the AML-C's slow stop function will help to minimize any safety risk.



- A: Over-front
- B: Over-rear
- C: Over-side
- D: Over-side
- E: Rated Load [ O/R max. ]
- F: Rated Load [ O/R mid. ]
- G: Rated Load [ O/R mid. ]
- H: Rated Load [ O/R min. ]

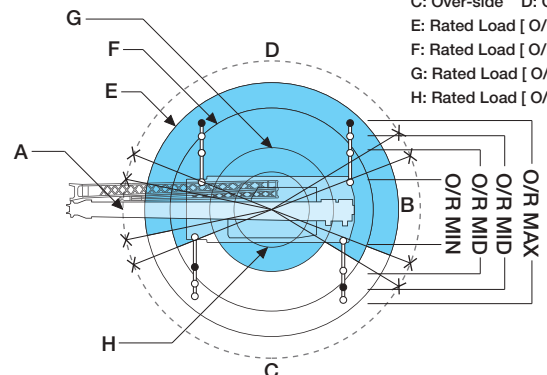

Outrigger Maximum extension

Outrigger Middle extension

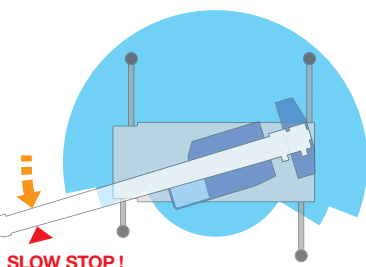

## Operator comfort

The crane cab provides improved livability and offers the operator a comfortable working environment.



Photo: GR-1000XL





Air conditioning and heating.

The control levers are smooth and responsive to the operators touch.



## Seat adjustment

Multiple seat adjustment positions for ease of operation.

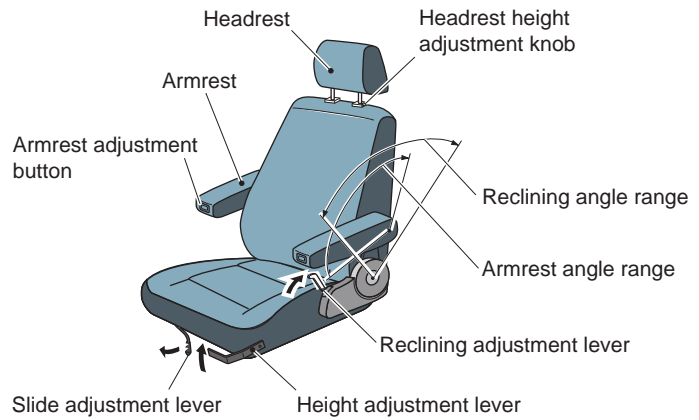

## Adjustment of control lever stand

- The control lever stand has a 3-stage adjustment feature.
- Before you enter or exit the cab, or when you complete the crane operation, set the control lever stand on the left to the stowing position.
- The unlock lever is used by pulling to adjust for all positions of the control lever stand.

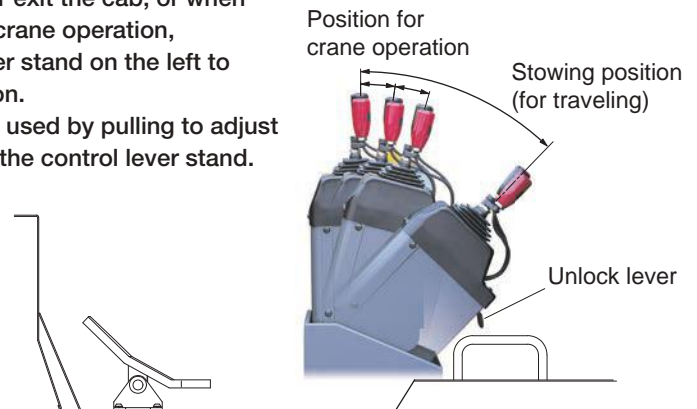

## Wider steps and hand rails



Photo: GR-1000XL, GR-750XL

Front steps



Photo: GR-1000XL, GR-750XL

Rear steps



Photo: GR-1000XL, GR-750XL

Left side steps



Photo: GR-1000XL, GR-750XL

Right side steps

# Ccarrier

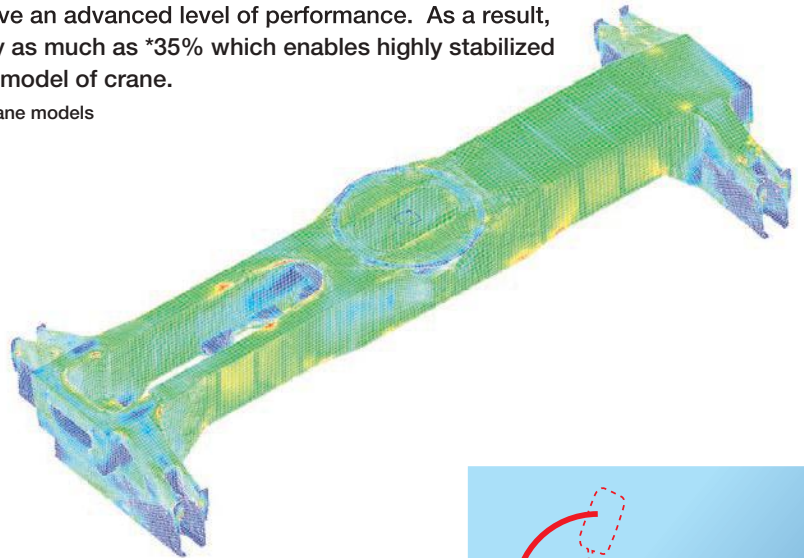

Photo: GR-1000XL

## New carrier frame (GR-1000XL, GR-750XL, GR-550XL)

The new carrier frame design was developed and built so that its lightweight is compatible with its high rigidity to achieve an advanced level of performance. As a result, the rigidity was enhanced by as much as \*35% which enables highly stabilized maneuverability for the new model of crane.

\*Compared with our conventional crane models



## High performance engine

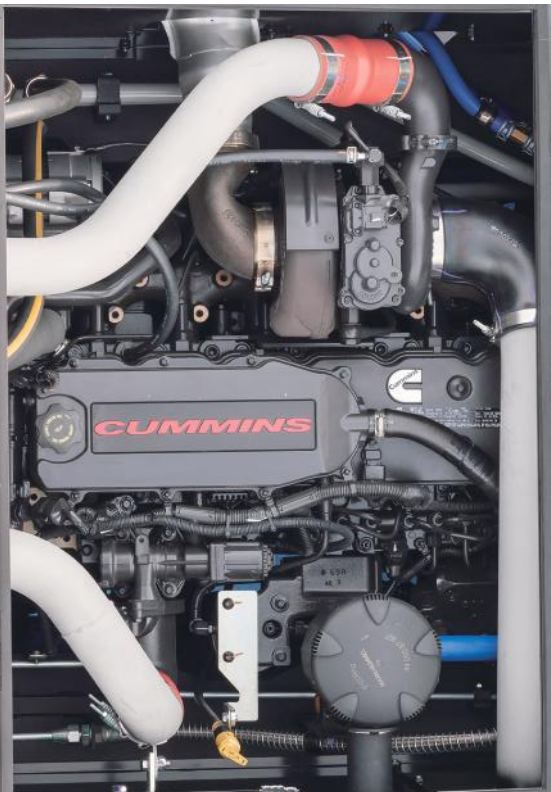

Cummins QSB6.7 [Tier 4]

## Winch drum monitoring mirror

(GR-1000XL, GR-750XL, GR-550XL)

Folding mirror reduces height during transport.

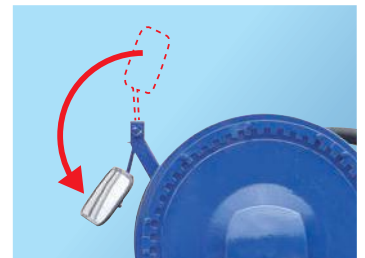

Model	Cummins QSB6.7 [Tier 4]
Type	4 cycle, turbo charged and after cooled, 6 cylinder in-line, direct injection, water cooled diesel engine.
Piston displacement	409 in <sup>3</sup> (6,700 cm <sup>3</sup> )





Photo: GR-1000XL

## Dashboard indicator and warning symbols

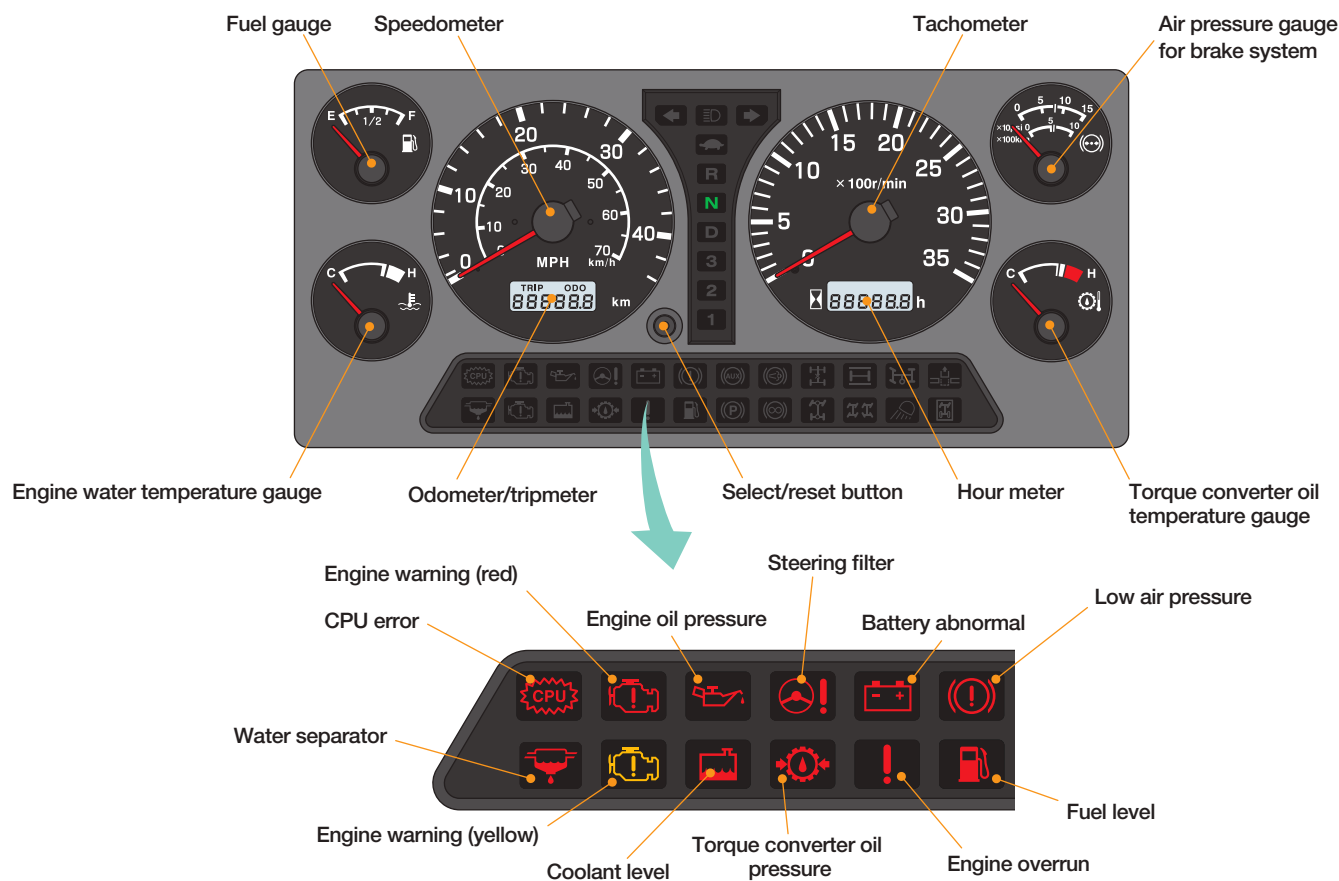

## Smooth transmission

- Electronically controlled, fully automatic transmission.
- Torque converter with full power shift driving axle selector.
- 6 forward and 2 reverse speeds, constant mesh.

### GR-1000XL, GR-750XL

3 speeds - High range - 2 wheel drive; 4 wheel drive  
3 speeds - Low range - 4 wheel drive

### GR-550XL

4 speeds - High range - 2 wheel drive; 4 wheel drive  
4 speeds - Low range - 4 wheel drive

### GR-350XL

4 speeds - High range - 2 wheel drive; 4 wheel drive  
4 speeds - Low range - 4 wheel drive

## Fastest traveling speed ( GR-550XL, GR-350XL )

Maximum traveling speed 31 MPH (50 km/h)  
Cummins Engine + 6 forward speeds transmission

## Comfortable suspension ( GR-550XL, GR-350XL )

Semi-elliptic leaf springs with hydraulic lockout device provide good riding comfort.

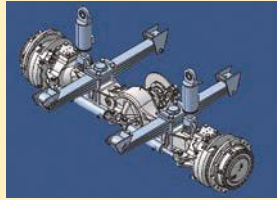

## Axle

Front: Full floating type, steering and driving axle with planetary reduction.  
Rear: Full floating type, steering and driving axle with planetary reduction and non-spin rear differential.

## Brake systems

Service: Air over hydraulic disc brakes on all 4 wheels.  
Parking/Emergency: Spring applied-air released brake acting on input shaft of front axle.  
Auxiliary: Electropneumatic operated exhaust brake.

## 4 steering modes

Hydraulic power steering



			GR-1000XL	GR-750XL	GR-550XL	GR-350XL
Traveling on roads Driving in work site		<b>2 wheel front</b> Front steering only. This steering method is the same as that of general vehicles.	<input type="checkbox"/>	<input type="checkbox"/>	<input type="checkbox"/>	<input type="checkbox"/>
		<b>2 wheel rear</b> Rear steering only. The rear end of the vehicle swings outward like a forklift. Useful for easy approach of a narrow area.	<input type="checkbox"/>	<input type="checkbox"/>	—	—
Driving in work site		<b>4 wheel coordinated</b> Front and rear wheels are steered in opposite directions. The turning radius is decreased. Useful for movement in a small area.	<input type="checkbox"/>	<input type="checkbox"/>	<input type="checkbox"/>	<input type="checkbox"/>
		<b>4 wheel crab</b> Front and rear wheels are steered in the same direction. The vehicle can move diagonally. Useful for pulling over.	<input type="checkbox"/>	<input type="checkbox"/>	<input type="checkbox"/>	<input type="checkbox"/>

## Self-removable counterweight ( GR-1000XL )

When using the auxiliary winch, dismantled counterweights can be lifted and moved for transport, and then remounted for operation at a work site without a helper crane.

Weight of removable counterweight: 22,000 lbs (9,979 kg)





## GR-1000XL

Max. traveling speed: 22 mph (36 km/h)  
 Overall length: approx. 47' 2" (14,375 mm)  
 Overall width: approx. 10' 10-1/2" (3,315 mm)  
 Overall height: approx. 12' 5-3/8" (3,795 mm)  
 Min. turning radius (at center of extreme outer tire)  
 2-wheel steering: 39' 1" (11.9 m)  
 4-wheel steering: 22' 4" (6.8 m)



## GR-750XL

Max. traveling speed: 22 mph (36 km/h)  
 Overall length: approx. 43' 10-3/4" (13,380 mm)  
 Overall width: approx. 10' 10-1/2" (3,315 mm)  
 Overall height: approx. 12' 5-1/2" (3,790 mm)  
 Min. turning radius (at center of extreme outer tire)  
 2-wheel steering: 39' 1" (11.9 m)  
 4-wheel steering: 22' 4" (6.8 m)



## GR-550XL

Max. traveling speed: 31 mph (50 km/h)  
 Overall length: approx. 42' 10" (13,055 mm)  
 Overall width: approx. 9' 9-3/8" (2,980 mm)  
 Overall height: approx. 12' 2-7/8" (3,730 mm)  
 Min. turning radius (at center of extreme outer tire)  
 2-wheel steering: 38' 5" (11.7 m)  
 4-wheel steering: 22' (6.7 m)



## GR-350XL

Max. traveling speed: 31 mph (50 km/h)  
 Overall length: approx. 36' 10-3/4" (11,245 mm)  
 Overall width: approx. 8' 10-1/2" (2,705 mm)  
 Overall height: approx. 11' 5" (3,480 mm)  
 Min. turning radius (at center of extreme outer tire)  
 2-wheel steering: 37' 5" (11.4 m)  
 4-wheel steering: 21' 4" (6.5 m)



# GR-1000XL

## WORKING RANGE

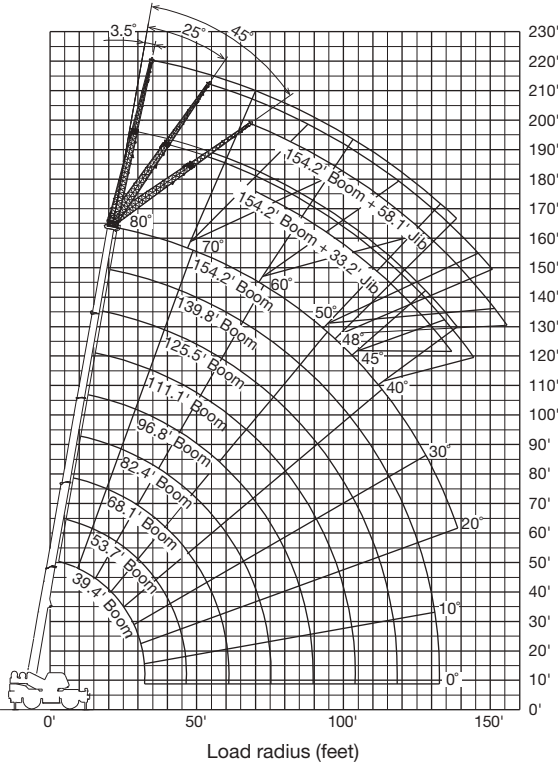

## DIMENSIONS

Note: Dimension is with boom angle at -1.5 degree.  
( ) Reference dimensions in mm.

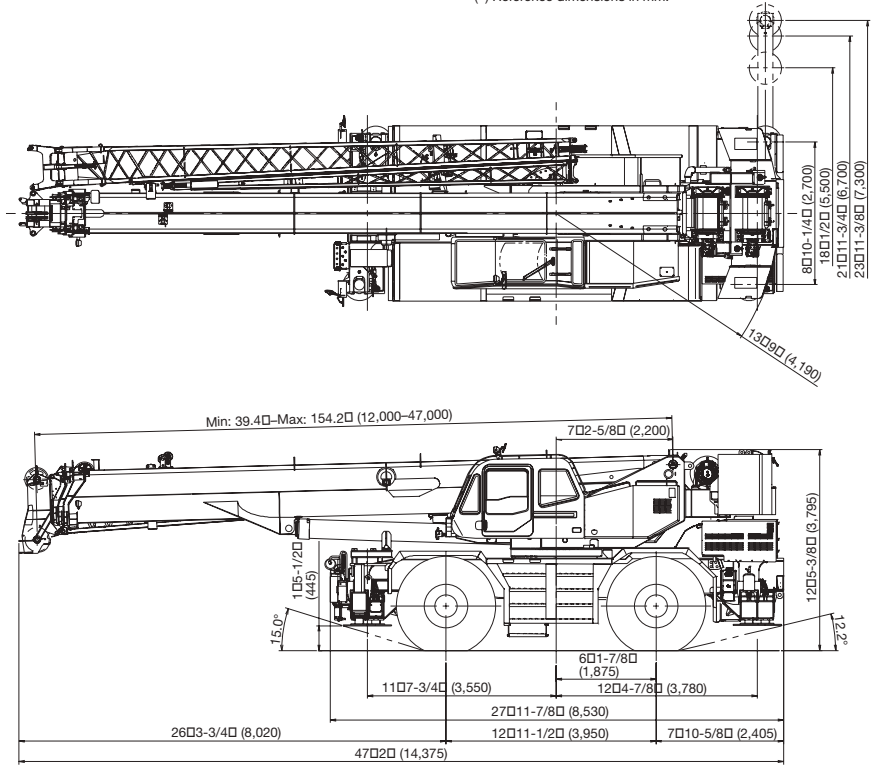

# GR-750XL

## WORKING RANGE

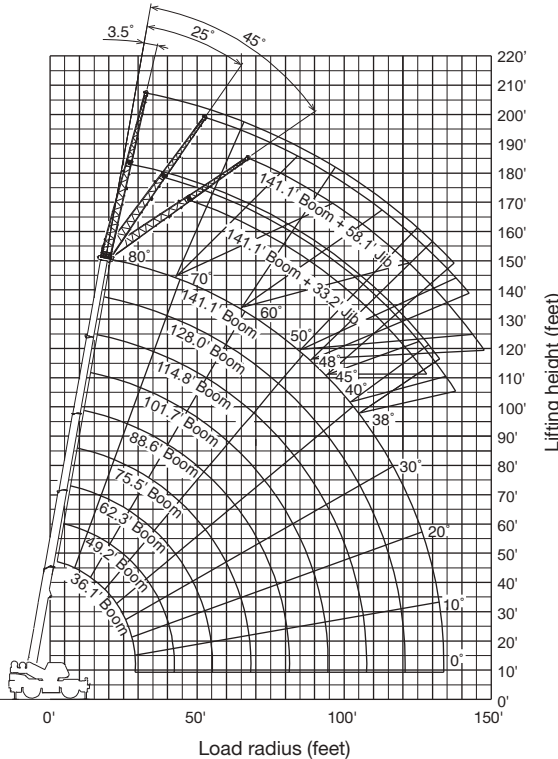

## DIMENSIONS

Note: Dimension is with boom angle at -1.6 degree.  
( ) Reference dimensions in mm.

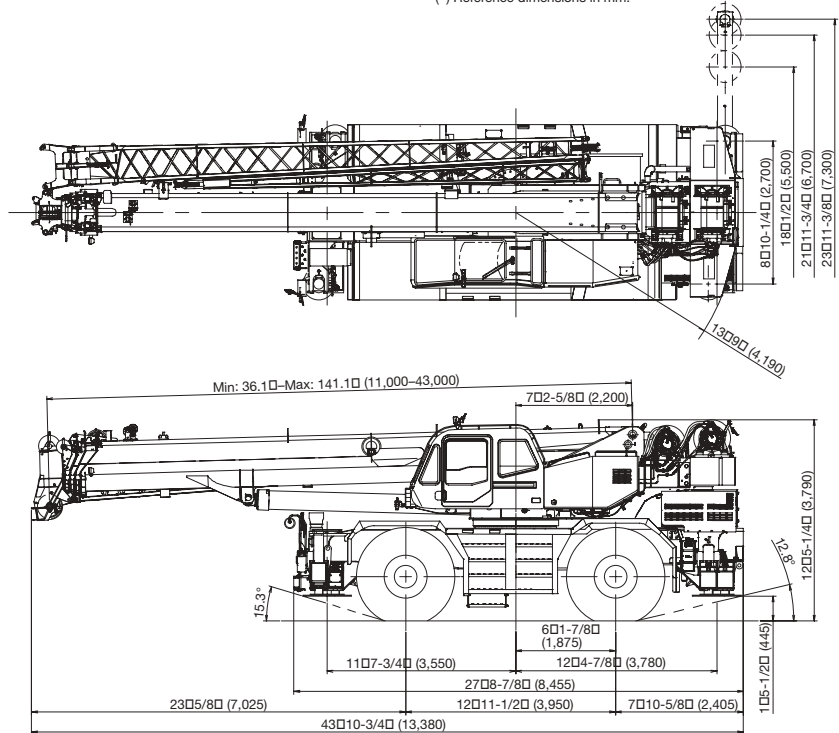



# GR-550XL

## WORKING RANGE

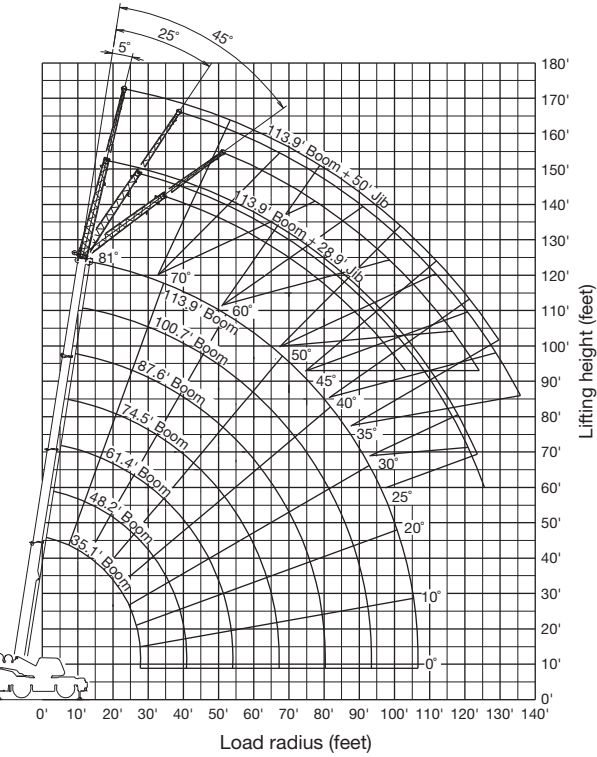

## DIMENSIONS

Note: Dimension is with boom angle at -0.8 degree.  
( ) Reference dimensions in mm.

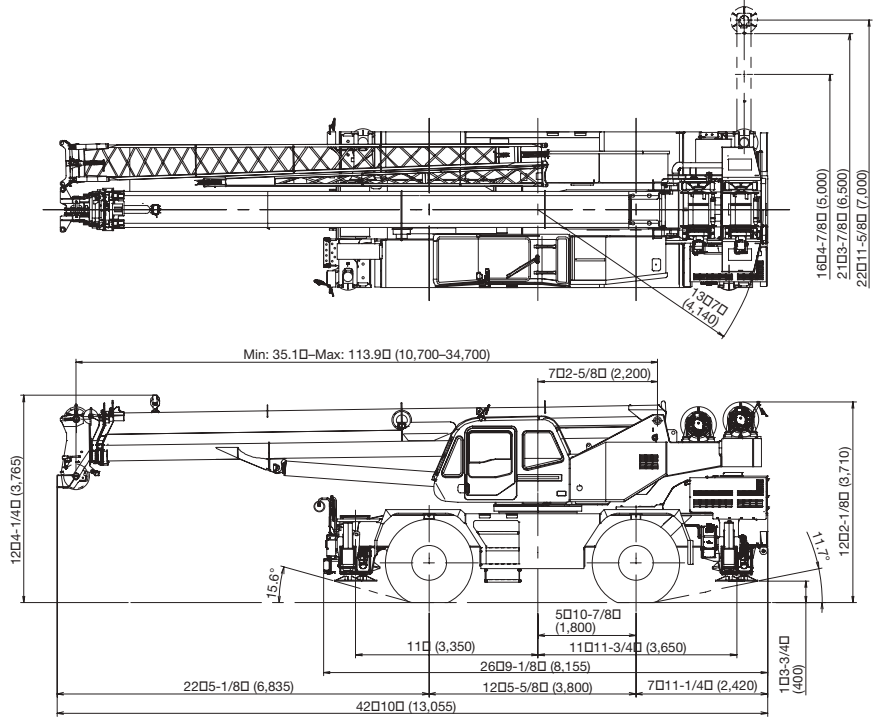

# GR-350XL

## WORKING RANGE

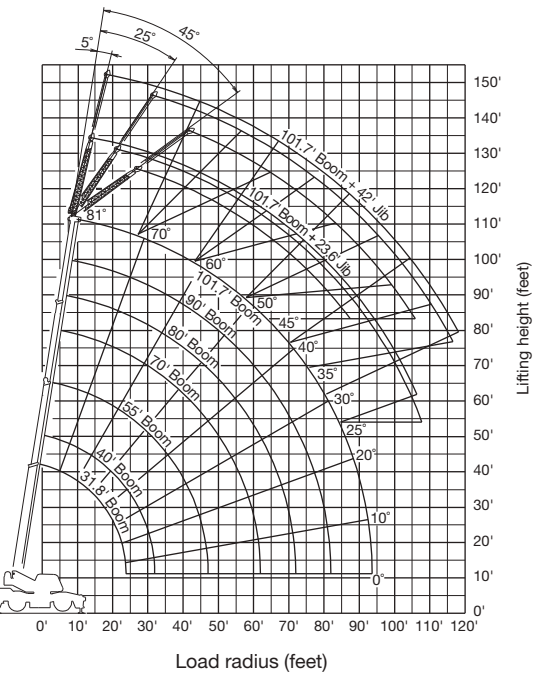

## DIMENSIONS

Note: Dimension is with boom angle at 0 degree.  
( ) Reference dimensions in mm.

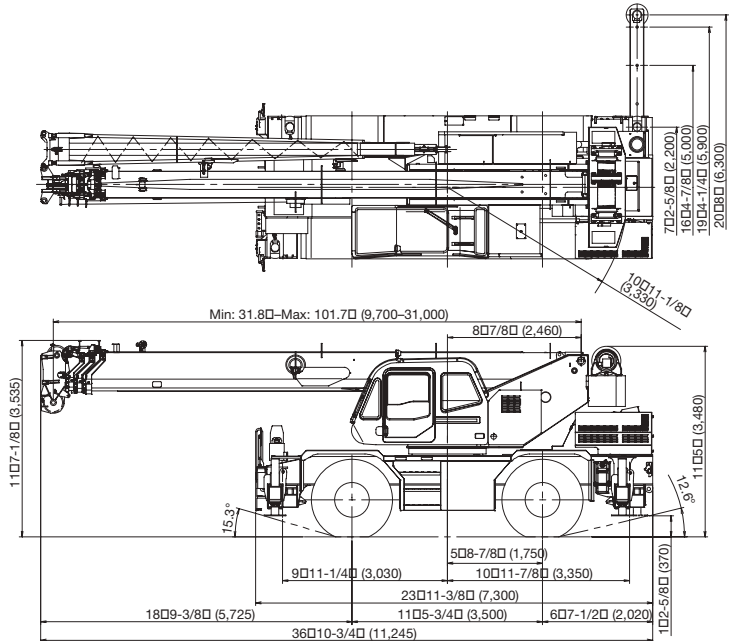

# SPECIFICATIONS

MODEL	GR-1000XL	GR-750XL
MAXIMUM CAPACITY	200,000 lbs at 8 ft (90,720 kg at 2.44 m)	150,000 lbs at 8 ft (68,040 kg at 2.44 m)
PERFORMANCE		
Max. Traveling speed	22 mph (36 km)	22 mph (36 km)
Gradeability (θ)	94 % (at stall) *Machine should be operated within the limit of engine crankcase design.	147 % (at stall) *Machine should be operated within the limit of engine crankcase design.
WEIGHT		
Gross vehicle mass	115,610 lbs (52,440 kg)	97,620 lbs (44,280 kg)
-front axle	57,340 lbs (26,010 kg)	49,650 lbs (22,520 kg)
-rear axle	58,270 lbs (26,430 kg)	47,970 lbs (21,760 kg)
MIN. TURNING RADIUS	39' 1" (11.9 m) (2-wheel steering: ), 22' 4" (6.8 m) (4-wheel steering) (at center of extreme outer tire)	39' 1" (11.9 m) (2-wheel steering: ), 22' 4" (6.8 m) (4-wheel steering) (at center of extreme outer tire)
BOOM		
5-section full power synchronized telescoping boom		
Fully retracted length	39.4' (12.0 m)	36.1' (11.0 m)
Fully extended length	154.2' (47.0 m)	141.1' (43.0 m)
Extension speed	114.8' (35.0 m) in 160 seconds	105' (32.0 m) in 128 seconds
Elevation speed	20° to 60° in 46 seconds	20° to 60° in 46 seconds
JIB		
2-staged bi-fold lattice type, Single sheave at jib head.		
Offset	3.5°/ 25°/ 45° (Tilt type)	3.5°/ 25°/ 45° (Tilt type)
Length	33.2' (10.1 m) or 58' 1" (17.7 m)	33.2' (10.1 m) or 58' 1" (17.7 m)
MAIN WINCH		
Variable speed type with grooved drum driven by hydraulic axial piston motor.		
Single line pull	14,600 lbs (6,600 kg)	12,300 lbs (5,600 kg)
Single line speed	491 ft/min (149 m/min) (at 4th layer)	420 ft/min (125 m/min) (at 4th layer)
Wire rope	830' of 3/4" (253 m of 19 mm)	771' of 3/4" (235 m of 19 mm)
AUXILIARY WINCH		
Variable speed type with grooved drum driven by hydraulic axial piston motor		
Single line pull	14,600 lbs (6,600 kg)	12,300 lbs (5,600 kg)
Single line speed	491 ft/min (149 m/min) (at 4th layer)	420 ft/min (125 m/min) (at 4th layer)
Wire rope	456' of 3/4" (139 m of 19 mm)	436' of 3/4" (133 m of 19 mm)
SLEWING		
Slewing speed	1.5 min <sup>-1</sup> {rpm}	2.4 min <sup>-1</sup> {rpm}
Tail slewing radius	13' 9" (4,190 mm)	13' 9" (4,190 mm)
HYDRAULIC SYSTEM		
Pumps... 2 variable piston pumps for crane functions.		
Tandem gear pump for steering, slewing and optional equipment.		
Control valves...		
Multiple valves actuated by pilot pressure with integral pressure relief valves.		
Reservoir...		
202 gallon (763 lit.) capacity. External sight level gauge.		
Oil cooler...		
Air cooled fan type.		
LOAD MOMENT INDICATOR (TADANO AML-C)		
Following information is displayed:		
•Control lever lockout function with audible and visual pre-warning •Boom position indicator •Outrigger state indicator •Boom angle / boom length / jib offset angle / jib length / load radius / rated lifting capacities / actual loads read out •Ratio of actual load moment to rated load moment indication •Automatic speed reduction and slow stop function for boom elevation and slewing •Working condition register switch •Load radius / boom angle / tip height / slewing range preset function •External warning lamp •Tare function •Fuel consumption monitor •Main hoist / auxiliary hoist select •Drum rotation indicator (audible and visual type) main and auxiliary hoist		
•Control lever lockout function with audible and visual pre-warning •Boom position indicator •Outrigger state indicator •Boom angle / boom length / jib offset angle / jib length / load radius / rated lifting capacities / actual loads read out •Ratio of actual load moment to rated load moment indication •Automatic speed reduction and slow stop function for boom elevation and slewing •Working condition register switch •Load radius / boom angle / tip height / slewing range preset function •External warning lamp •Tare function •Fuel consumption monitor •Main hoist / auxiliary hoist select •Drum rotation indicator (audible and visual type) main and auxiliary hoist		
OUTRIGGERS		
4 hydraulic, beam and jack outriggers. Vertical jack cylinders equipped with integral holding valve. Each outrigger beam and jack is controlled independently from cab.		
Extension width	Max... 23' 11-3 / 8" (7.3 m), Mid... 21' 11-3 / 4" (6.7 m) & 18' 1-2" (5.5 m), Min ... 8' 10-1 / 4" (2.7 m), Float size (Diameter) ...1' 11-5 / 8" (0.6 m)	Max... 23' 11-3 / 8" (7.3 m), Mid... 21' 11-3 / 4" (6.7 m) & 18' 1-2" (5.5 m), Min ... 8' 10-1 / 4" (2.7 m), Float size (Diameter) ...1' 11-5 / 8" (0.6 m)
CARRIER		
Rear engine, left-hand drive, driving axle 2-way selected type by manual switch.		
4 x 2 front drive, 4 x 4 front and rear drive.		
ENGINE		
4 cycle, turbo charged and after cooled, 6-cylinder, direct injection diesel.		
Piston displacement... 409 in. (6.700 liters)		
Bore x stroke... 4.212 in. x 4.882 in. (107 mm x 124 mm)		
Max. output... Gross 270 HP (201 kW) at 2,400 rpm		
Max. Torque... 730 ft-lb (990 N-m) at 1,500 rpm		
TRANSMISSION		
Electronically controlled fully automatic transmission.		
STEERING		
Hydraulic power steering.		
4 steering modes available:		
2-wheel front, 2-wheel rear, 4-wheel coordinated, 4-wheel crab		
SUSPENSION		
Front..... Rigid mounted to the frame.		
Rear..... Pivot mounted with hydraulic lockout device.		
TIRES		
29.5 - 25 34PR (OR)		
29.5 - 25 22PR(OR) or 29.5 - 25 28PR(OR)		
FUEL TANK CAPACITY		
79.2 gallon (300 liters)		



MODEL	GR-550XL	GR-350XL
MAXIMUM CAPACITY	110,000 lbs at 8 ft (50,000 kg at 2.44 m)	70,000 lbs at 8 ft (31,752 kg at 2.44 m)
PERFORMANCE		
Max. Traveling speed	31 mph (50 km)	31 mph (50 km)
Gradeability (θ)	69 % (at stall) *Machine should be operated within the limit of engine crankcase design.	78 % (at stall) *Machine should be operated within the limit of engine crankcase design.
WEIGHT		
Gross vehicle mass	74,850 lbs (33950 kg)	60,830 lbs (27,590 kg)
-front axle	38,500 lbs (17,460 kg)	30,380 lbs (13,780 kg)
-rear axle	36,350 lbs (16,490 kg)	30,450 lbs (13,810 kg)
MIN. TURNING RADIUS	38' 5" (11.7 m) (2-wheel steering: ), 22' (6.7 m) (4-wheel steering) (at center of extreme outer tire)	37' 5" (11.4 m) (2-wheel steering: ), 21' 4" (6.5 m) (4-wheel steering) (at center of extreme outer tire)
BOOM		
Fully retracted length	4-section full power synchronized telescoping boom. 35.1' (10.7 m)	4-section full power synchronized telescoping boom. 31.8' (9.7 m)
Fully extended length	113.9' (34.7 m)	101.7' (31.0 m)
Extension speed	78.8' (24.0 m) in 72 seconds	69.9' (21.3m) in 91 seconds
Elevation speed	20° to 60° in 27 seconds	20° to 60° in 22 seconds
JIB		
Offset	2-staged bi-fold lattice type, Single sheave at jib head.	2-staged lattice type, Single sheave at jib head.
Length	5°/ 25°/ 45° (Tilt type) 28.9' (8.8 m) or 50' (15.2 m)	5°/ 25°/ 45° (Tilt type) 23.6' (7.2 m) or 42' (12.8 m)
MAIN WINCH		
Single line pull	Variable speed type with grooved drum driven by hydraulic axial piston motor. 12,300 lbs (5,600 kg)	Variable speed type with grooved drum driven by hydraulic axial piston motor. 8,820 lbs (4,000 kg)
Single line speed	420 ft/min (125 m/min) (at 4th layer)	410 ft/min (125 m/min) (at 4th layer)
Wire rope	633' of 3/4" (193 m of 19 mm)	558' of 5/8" (170 m of 16 mm)
AUXILIARY WINCH		
Single line pull	Variable speed type with grooved drum driven by hydraulic axial piston motor 12,300 lbs (5,600 kg)	Variable speed type with grooved drum driven by hydraulic axial piston motor 8,820 lbs (4,000 kg)
Single line speed	361 ft/min (110 m/min) (at 2nd layer)	410 ft/min (125 m/min) (at 4th layer)
Wire rope	361' of 3/4" (110 m of 19 mm)	322' of 5/8" (98 m of 16 mm)
SLEWING		
Slewing speed	2.7 min <sup>-1</sup> {rpm}	3.2 min <sup>-1</sup> {rpm}
Tail slewing radius	13' 7" (4,140 mm)	10' 11" - 1/8" (3,330mm)
HYDRAULIC SYSTEM		
Pumps...	2 variable piston pumps for crane functions. Tandem gear pump for steering, slewing and optional equipment.	2 variable piston pumps for crane functions. Tandem gear pump for steering, slewing and optional equipment.
Control valves...	Multiple valves actuated by pilot pressure with integral pressure relief valves.	Multiple valves actuated by pilot pressure with integral pressure relief valves.
Reservoir...	148 gallon (560 lit.) capacity. External sight level gauge.	100 gallon (380 lit.) capacity. External sight level gauge.
Oil cooler...	Air cooled fan type.	Air cooled fan type.
LOAD MOMENT INDICATOR (TADANO AML-C)		
Following information is displayed:	•Control lever lockout function with audible and visual pre-warning • Boom position indicator •Outrigger state indicator •Boom angle / boom length / jib offset angle / jib length / load radius / rated lifting capacities / actual loads read out •Ratio of actual load moment to rated load moment indication •Automatic speed reduction and slow stop function for boom elevation and slewing •Working condition register switch •Load radius / boom angle / tip height / slewing range preset function •External warning lamp •Tare function •Fuel consumption monitor •Main hoist / auxiliary hoist select •Drum rotation indicator (audible and visual type) main and auxiliary hoist	•Control lever lockout function with audible and visual pre-warning •Boom position indicator •Outrigger state indicator •Boom angle / boom length / jib offset angle / jib length / load radius / rated lifting capacities / actual loads read out •Ratio of actual load moment to rated load moment indication •Automatic speed reduction and slow stop function for boom elevation and slewing •Working condition register switch •Load radius / boom angle / tip height / slewing range preset function •External warning lamp •Tare function •Fuel consumption monitor •Main hoist / auxiliary hoist select •Drum rotation indicator (audible and visual type) main and auxiliary hoist
OUTRIGGERS		
Extension width	4 hydraulic, beam and jack outriggers. Vertical jack cylinders equipped with integral holding valve. Each outrigger beam and jack is controlled independently from cab. Max... 22' 11-5 / 8" (7.0 m), Mid... 21' 3-7 / 8" (6.5 m) & 16' 4-7 / 8" (5.0 m), Min ... 8' 1-5 / 8" (2.48 m), Float size (Diameter) ...1' 7-11 / 16" (0.5 m)	4 hydraulic, beam and jack outriggers. Vertical jack cylinders equipped with integral holding valve. Each outrigger beam and jack is controlled independently from cab. Max... 20' 8" (6.3 m), Mid... 19' 4-1 / 4" (5.9 m) & 16' 4-7 / 8" (5.0 m), Min ... 7' 2-5 / 8" (2.2 m), Float size (Diameter) ...1' 3-3 / 4" (0.4 m)
CARRIER	Rear engine, left-hand drive, driving axle 2-way selected type by manual switch. 4 x 2 front drive, 4 x 4 front and rear drive.	Rear engine, left-hand drive, driving axle 2-way selected type by manual switch. 4 x 2 front drive, 4 x 4 front and rear drive.
ENGINE	4 cycle, turbo charged and after cooled, 6-cylinder, direct injection diesel. Piston displacement... 409 in. (6.700 liters) Bore x stroke... 4.212 in. x 4.882 in. (107 mm x 124 mm) Max. output... Gross 270 HP (201 kW) at 2,400 rpm Max. Torque... 730 ft-lb (990 N·m) at 1,500 rpm	4 cycle, turbo charged and after cooled, 6-cylinder, direct injection diesel. Piston displacement... 409 in. (6.700 liters) Bore x stroke... 4.212 in. x 4.882 in. (107 mm x 124 mm) Max. output... Gross 235 HP (175 kW) at 2,300 rpm Max. Torque... 655 ft-lb (888 N·m) at 1,500 rpm
TRANSMISSION	Electronically controlled fully automatic transmission.	Electronically controlled fully automatic transmission.
STEERING	Hydraulic power steering. 3 steering modes available: 2-wheel front, 4-wheel coordinated, 4-wheel crab	Hydraulic power steering. 3 steering modes available: 2-wheel front, 4-wheel coordinated, 4-wheel crab
SUSPENSION	Semi-elliptic leaf springs with hydraulic lockout device.	Semi-elliptic leaf springs with hydraulic lockout device.
TIRES	23.5 - 25 (OR)	20.5 - 25 (OR)
FUEL TANK CAPACITY	79.2 gallon (300 liters)	79.2 gallon (300 liters)

\*Some specifications are subject to change without prior notification.



**GR-1000XL (100 TON)**



**GR-750XL (75 TON)**



**GR-550XL (55 TON)**



**GR-350XL (35 TON)**



**TADANO AMERICA Corporation**

4242 West Greens Road, Houston, TX 77066

Tel: 281-869-0030 Fax: 281-869-0040

www.tadanoamerica.com Email: sales@tadano-cranes.com

Parts Hotline: 713-865-1041 Service Hotline: 281-869-5925