

Grove RT765E-2

Product Guide



Features

- 60 t (65 USt) capacity
- 11 m – 33,5 m (36 ft – 110 ft) four-section full power boom
- 10,1 m (33 ft) offsettable lattice swingaway extension
- 10,1 m - 17,1 m (33 ft - 56 ft) bi-fold lattice swingaway extension
- 6,1 m (20 ft) or 12,2 m (40 ft) extension inserts
- 6516 kg (14,365 lb) counterweight pinned to superstructure



Features

MEGAFORM™ boom

The superstructure features a full-power four-section MEGAFORM™ boom that can reach to a maximum tip height of 119 ft. The sequence synchronized extension features telescopic boom sections via a single lever joystick controller.



Extensions

An optional bi-fold swingaway lattice extension easily stows on the side of the base boom for easy transport while providing on-board extension from 33 ft - 56 ft for a maximum tip height of 174.5 ft. By adding inserts of 20 ft or 40 ft, the maximum tip height on the RT765E-2 can be extended even further to 194 ft or 214 ft.

An optional 33 ft fixed swingaway is also available with a maximum tip height of 150 ft.

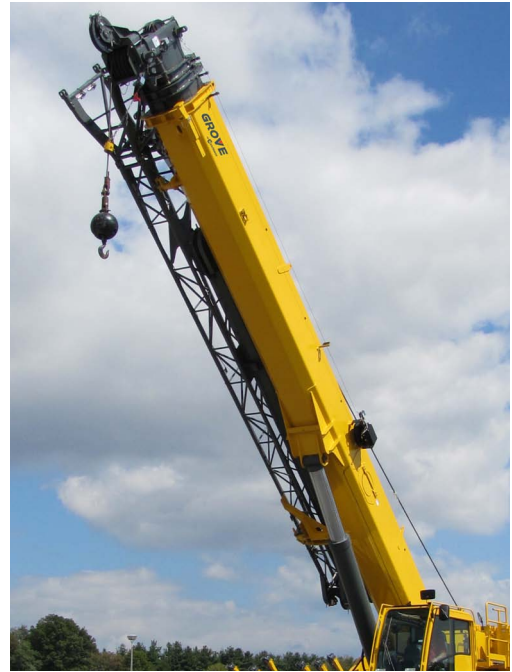

CraneSTAR

CraneSTAR is an exclusive and innovative crane asset management system that helps improve your profitability and reduce costs by remotely monitoring critical crane data. Visit www.cranestar.com for more information.



Smooth operation

The RT765E-2 has a quick-reeve boom nose and swingaway alignment device to help operators set up smoothly.

Contents

Specifications	4
Dimensions and weights	7
Working range	8
Load charts	9
Symbols glossary	10

Specifications

Superstructure

Boom

11 m - 33,5 m (36 ft - 110 ft) four-section, full-power sequenced synchronized boom.

Maximum tip height: 36,4 m (119 ft).

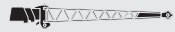

*Optional fixed swingaway extension

10,1 m (33 ft) offsettable lattice swingaway extension. Offsettable at 0°, 25° and 45°. Stows alongside base boom section.

Maximum tip height: 45,8 m (150 ft).



*Optional bi-fold swingaway extension

10,1 m - 17,1 m (33 ft - 56 ft) bi-fold lattice swingaway extension. Offsettable at 0°, 25° and 45°. Stows alongside base boom section. Maximum tip height: 53,2 m (174.5 ft).



*Optional 6,1 m (20 ft) or 12,2 m (40 ft) inserts

Installs between boom nose and bi-fold extension, non-stowable. Maximum tip height: 59,1 m (194 ft) with 20 ft insert, 65,2 m (214 ft) with 40 ft insert.



Boom nose

Four nylatron sheaves mounted on heavy-duty tapered roller bearings with removable pin-type rope guards. Quick-reeve type boom nose.

*Optional removable auxiliary boom nose with removable pin type rope guard.



Boom elevation

One double-acting hydraulic cylinder with integral holding valve provides elevation from -3° to 78°.



Load moment and anti-two block system

Standard "Graphic Display" load moment and anti-two block system with audio-visual warning and control lever lockout. These systems provide electronic display of boom angle, length, radius, tip height, relative load moment, maximum permissible load, load indication and warning of impending two-block condition. The standard Work Area Definition System allows the operator to pre-select and define safe working areas. If the crane approaches the pre-set limits, audio-visual warnings aid the operator in avoiding job-site obstructions.



Cab

Full-vision, all-steel fabricated with acoustical lining and tinted safety glass throughout. Deluxe seat incorporates armrest-mounted hydraulic single-axis controllers. Tilt/telescoping steering wheel with various controls incorporated into the steering column. Other standard features include: hot water heater, cab circulating air fan, sliding side and rear windows, sliding skylight with electric wiper and sunscreen, electric windshield wash/wipe, fire extinguisher, seat belt, air conditioning, and dual cab mounted work light.



Swing

Planetary swing with foot-applied multi-disc brake. Spring applied, hydraulically-released swing brake and plunger-type, one position, mechanical house lock operated from cab. *Optional 360° mechanical swing lock. Maximum speed: 2.5 rpm.



Counterweight

6516 kg (14,365 lb) pinned to superstructure.



Hydraulic system

Three main gear pumps with a combined capacity of 465 LPM (123 GPM).

Maximum operating pressure: 27,6 MPa (4000 psi). Two individual post pressure compensated valve banks. Return line type filter with full flow by-pass protection and service indicator. Replaceable cartridge with micron filtration rating of 5/12/16. 507 L (134 gallon) reservoir. Integral oil cooler. System pressure test ports.



Hoist specifications (GHP30A) main and auxiliary hoist

Main and auxiliary hoist: Model GHP30A

Planetary reduction with automatic spring applied multi-disc brake. Grooved drum. Electronic hoist drum rotation indicator and hoist drum cable followers.

Maximum single line pull: 8246 kg (20,250 lb)

Maximum single line speed: 156 m/min (513 fpm)

Maximum permissible line pull:

7620 kg (16,800 lb) with standard 6 x 37 class rope

7620 kg (16,800 lb) with optional 35 x 7 class rope

Specifications

Superstructure continued

Rope diameter: 19 mm (3/4 in)

Rope length: 152 m (500 ft)

*Optional 152 m (500 ft) 35 x 7 class rope

Rope type: 6 x 37 class EIPS IWRC

*Optional 35 x 7 class rotation resistant

Maximum usable rope stowage: 170 m (559 ft).

Carrier



Chassis

Box section frame fabricated from high-strength, low alloy steel. Integral outrigger housings and front/rear towing, lifting, and tie down lugs.



Outrigger system

Four hydraulic telescoping single-stage double box beam outriggers with inverted jacks and integral holding valves. Three position settings, 100%, 50% and fully retracted. All steel fabricated, quick-release type round outrigger floats, 610 mm (24 in) diameter. Maximum outrigger pad load: 41 731 kg (92,000 lb). Outrigger position monitoring system.



Outrigger controls

Controls and crane level indicator located in cab.



Engine (Tier III)

Cummins QSB 6.7 L diesel, six cylinders, turbocharged, 179 kW (240 bhp) (Gross) at 2500 rpm. Maximum torque: 987 N-m (728 ft lb) at 1500 rpm.

Note: Required for sale outside of North American and European Union countries



Engine (Tier IV)

Cummins QSB 6.7 L diesel, six cylinders, turbocharged with Cummins Diesel Particulate Exhaust filter/muffler. Meets emissions per U.S.E.P.A. Tier IV and E.U. Stage III B. 179 kW (240 bhp) at 2500 rpm. Maximum torque: 990 N-m (730 ft lb) at 1500 rpm.

Fuel requirement: Maximum of 15 ppm sulphur content (Ultra Low Diesel Fuel).

Note: Tier IV engine Required in North American and European Union countries.



Fuel tank capacity

280 L (74 gal)



Transmission

Spicer powershift with 6 forward and 6 reverse speeds (3 speeds high and 3 speeds low). Front axle disconnect for 4 x 2 travel.



Electrical system

Three 12-volt maintenance free batteries. 12-volt starting and lighting, circuit breakers, battery disconnect switch.



Drive

4 x 4



Steering

Fully independent power steering:

Front: Full hydraulic, steering wheel controlled.

Rear: Full hydraulic, switch controlled.

Provides infinite variations of 4 main steering modes: front only, rear only, crab and coordinated.

Rear steer centered indicating light.

4 wheel outside turning radius - 6,7 m (22.1 ft).



Axles

Front: Drive/steer with differential and planetary reduction hubs rigid-mounted to frame.

Rear: Drive/steer with differential and planetary reduction hubs pivot-mounted to frame.

Automatic full hydraulic lockouts on rear axle permit 203 mm (8 in) oscillation only with boom centered over the front.



Brakes

Full hydraulic split circuit brakes operating on all wheels. Spring-applied, hydraulically released axle-mounted parking brake.



Tires

29.5 x 25 - 28PR bias earthmover type.

Specifications

Carrier continued

Lights

Full lighting package including turn indicators, head, tail, brake and hazard warning lights.

Maximum speed

37 km/h (23 mph).

Gradeability (theoretical)

130% (Based on 42 388 kg [93,447 lb] GVW) 29.5 x 25 tires, pumps engaged, 33,6 m (110 ft) boom, bi-fold extension, aux. hoist and cable, and 65 USt hook block.

Miscellaneous standard equipment

Full width steel fenders, full length steel decking, dual rear view mirrors, hook block tiedown, electronic back-up alarm, light package, front stowage well, tachometer, rear wheel position indicator, 36,000 BTU hot water heater, air conditioning package with 28,500 BTU hydraulic driven air conditioning, hoist mirrors, engine distress A/V warning system. Auxiliary hoist control valve arrangement (less hoist). Cold start aid and immersion type engine block heater, 120V 1500 watt. Hoist access platform, CraneSTAR asset management system, Outrigger position monitoring system.

*Optional equipment

- ▶ Auxiliary Hoist Package (includes Model HP30A-19G auxiliary hoist with electronic hoist drum rotation indicator, hoist drum cable follower, 152 m (500 ft) of 19 mm (3/4 in) 35 X 7 class wire rope, auxiliary single sheave boom nose.
- ▶ Auxiliary Light and Convenience Package: includes superstructure mounted amber flashing light, in-cab LMI light bar, and dual base boom mounted floodlights, rubber mat for stowage trough
- ▶ “CE” Mark Conformance (sound abatement foam kits, 3rd wrap indicator, emergency auxiliary steering, dual axis joystick controllers)
- ▶ Cross axle differential locks (front and rear)
- ▶ Manual pump disconnect
- ▶ Pintle hook - rear
- ▶ 360° NYC style positive swinglock
- ▶ PAT event recorder
- ▶ Hydraulic removable counterweight
- ▶ 3rd wrap indicator with function lockout for main hoist or main and auxiliary hoist
- ▶ Wireless windspeed indicator

Dimensions and weights

Dimensions

Tire size	A	B	C	D	E	F	G	A	B	C	D	E	F	G	H
29.5-25	14 961 mm (589")	15 368 mm (605")	12 460 mm (491")	11 732 mm (462")	11 342 mm (446")	9 004 mm (355")	7 662 mm (302")	10 922 mm (430")	11 153 mm (439")	7 830 mm (308")	7 099 mm (280")	6 744 mm (266")	4 368 mm (172")	3 496 mm (138")	2 499 mm (98.37")
2 Wheel Steer								4 Wheel Steer							

Dimensions for table are represented in millimeters (inches), exact.

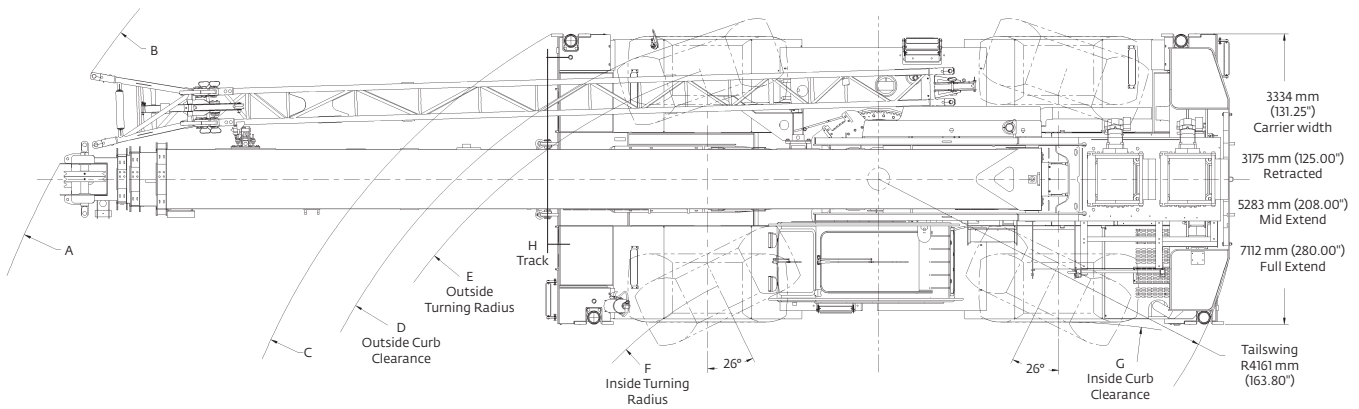
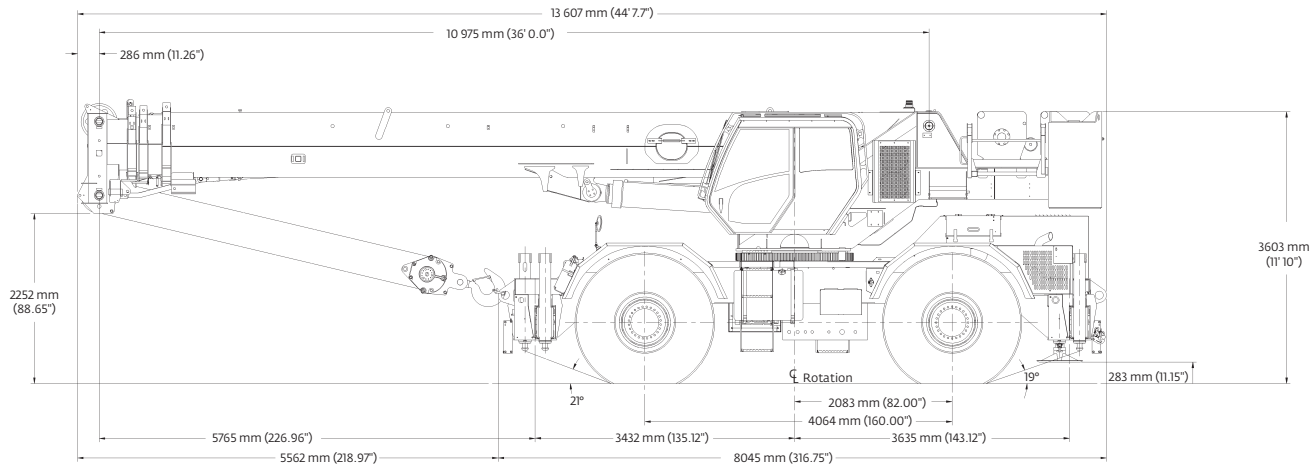

Weights	GVW		Front		Rear	
	kg	lb	kg	lb	kg	lb
Basic Machine: Including 110 ft main boom, main hoist with 500 ft of wire rope, auxiliary hoist with 500 ft of wire rope, full pinned counterweight, full Decking, A/C, and hoist access platform	40 381	89 024	18 495	40,773	21 887	48,251
ADD: 33 ft -56 ft bi-fold swingaway + extension carrier brackets + aux. boom nose	1265	2788	1997	4402	-732	-1614
Crane Weight	41 646	91,812	20 491	45,175	21 155	46,637
ADD: 60 t (65 USt) 5-sheave hookblock stowed in trough	480	1280	480	1280	0	0
Crane Weight	42 227	93,092	21 072	46,455	21 155	46,637
ADD: 7,5 t (8.3 USt) headache ball tied to O/R cable	161	355	262	578	-101	-223
Crane Weight	42 388	93,447	21 334	47,033	21 053	46,414

Working range

110 ft main boom with 33 ft - 56 ft bi-fold swingaway

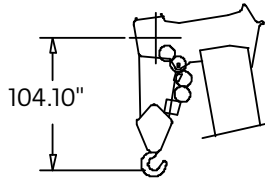
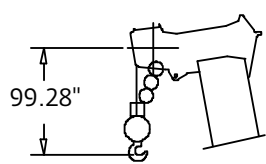
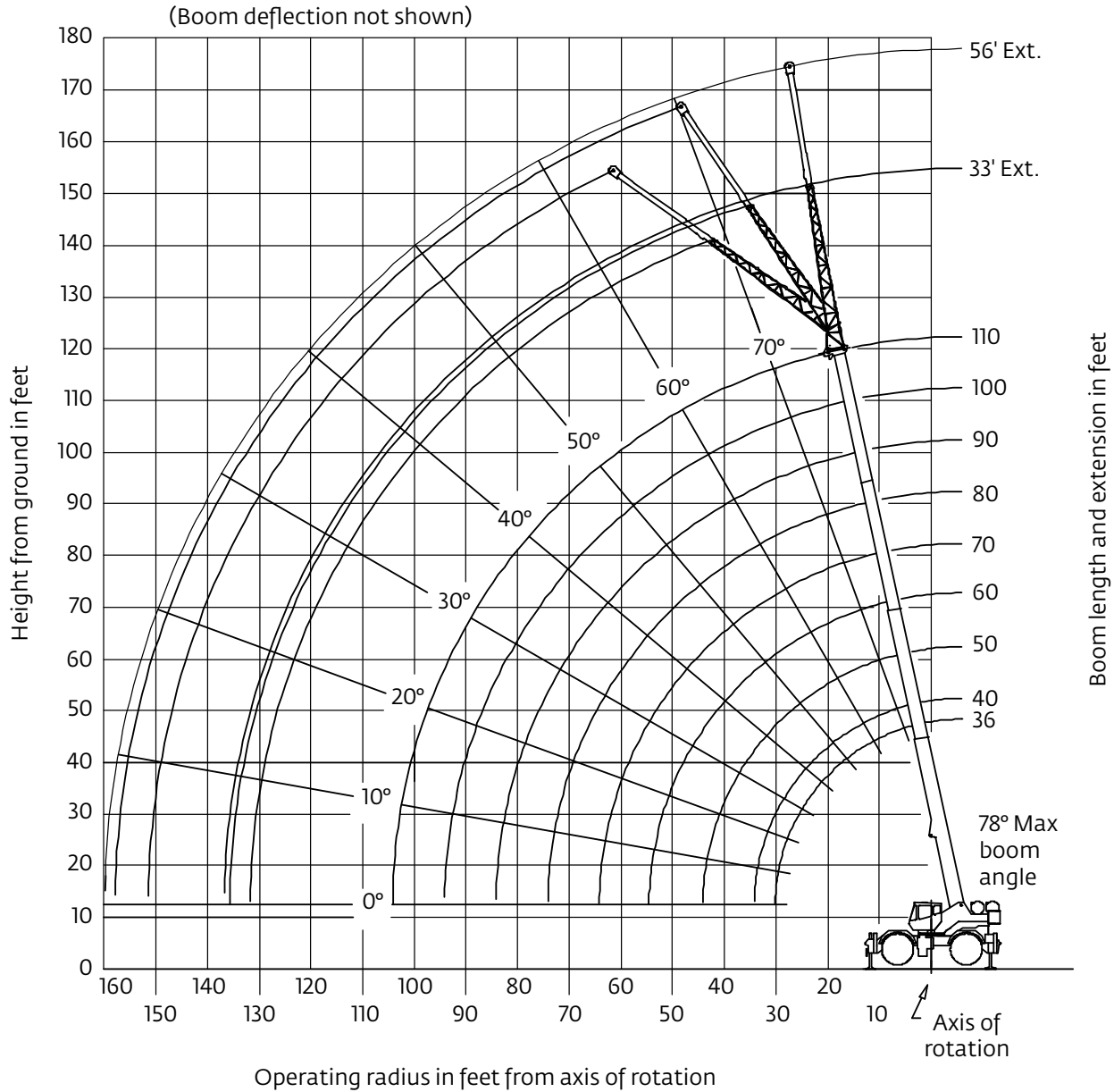

Dimensions are for largest Grove furnished hook block and headache ball, with anti-two block activated.

THIS CHART IS ONLY A GUIDE AND SHOULD NOT BE USED TO OPERATE THE CRANE.

The individual crane's load chart, operating instructions and other instructional plates must be read and understood prior to operating the crane

Working range

110 ft main boom with one insert and 33 ft - 56 ft bi-fold swingaway

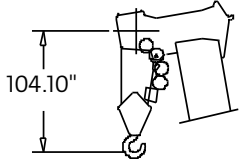
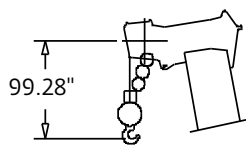
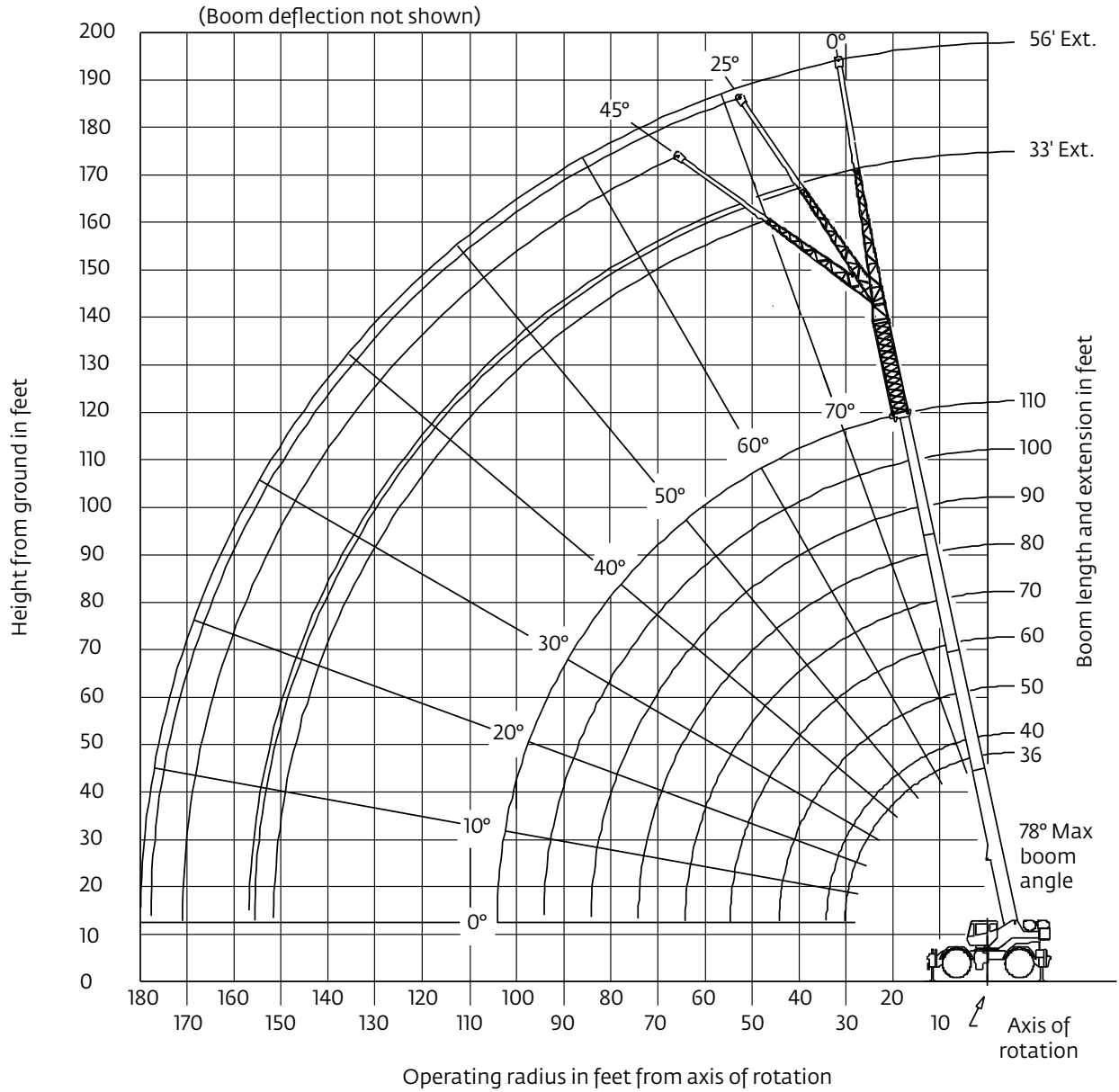

Dimensions are for largest Grove furnished hook block and headache ball, with anti-two block activated.

Working range

110 ft main boom with two inserts and 33 ft - 56 ft bi-fold swingaway

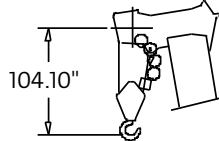
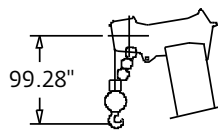
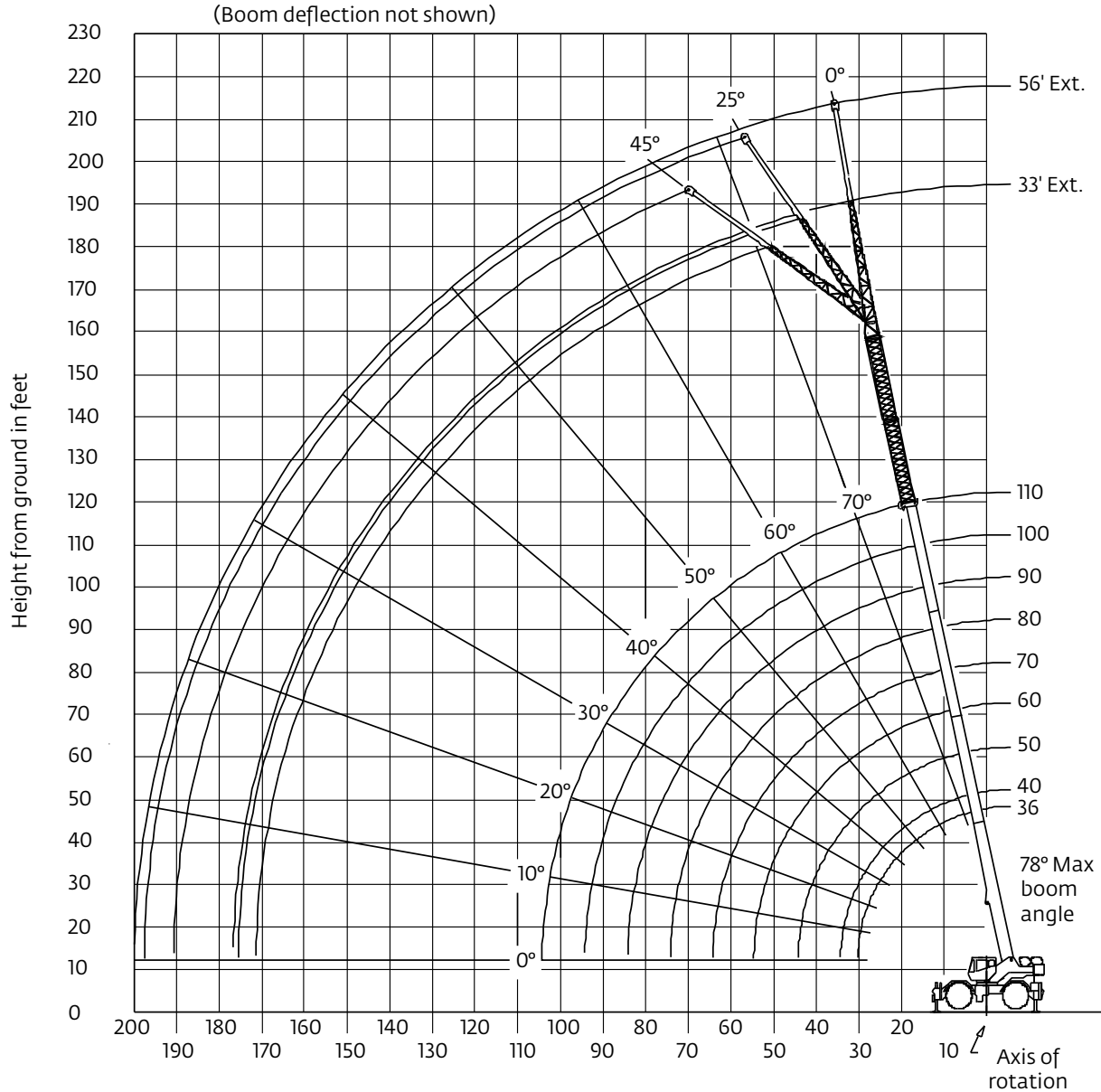

Dimensions are for largest Grove furnished hook block and headache ball, with anti-two block activated.

THIS CHART IS ONLY A GUIDE AND SHOULD NOT BE USED TO OPERATE THE CRANE.

The individual crane's load chart, operating instructions and other instructional plates must be read and understood prior to operating the crane

Load chart





36 ft - 110 ft **14,365 lb** **23 ft 4 in (100%)** **360°**

Radius in feet	#0001								
	Main boom length in feet								
	36	40	50	**60	70	80	90	100	110
10	130,000 (69.5)	90,300 (71.5)	90,300 (75.5)	*62,500 (78)					
12	112,500 (65.5)	90,300 (68.5)	90,300 (73)	62,500 (76.5)	*40,200 (78)				
15	93,250 (60)	90,300 (63.5)	90,250 (69.5)	62,500 (73.5)	40,200 (76)	*40,200 (78)			
20	71,550 (49.5)	71,500 (55)	71,300 (63)	62,500 (68)	40,200 (71.5)	40,200 (74.5)	40,200 (78)	*36,900 (78)	
25	56,650 (36.5)	56,600 (45)	56,350 (56)	53,650 (63)	40,200 (67)	40,200 (70.5)	37,950 (73)	34,900 (75)	*25,150 (78)
30	43,500 (11.5)	44,300 (32)	43,950 (48.5)	43,650 (57.5)	40,200 (62.5)	36,050 (66.5)	32,750 (69.5)	30,200 (72)	25,150 (74)
35			33,550 (40)	33,700 (51.5)	34,700 (58)	31,450 (62.5)	28,550 (66)	26,400 (69)	24,700 (71.5)
40			25,800 (28)	26,150 (44.5)	26,900 (52.5)	27,700 (58.5)	25,200 (62.5)	23,300 (66)	21,800 (68.5)
45				20,650 (36.5)	21,450 (47)	22,300 (54)	22,400 (59)	20,700 (62.5)	19,400 (65.5)
50				16,550 (26.5)	17,400 (41)	18,250 (49.5)	19,100 (55)	18,550 (59.5)	17,350 (62.5)
55					14,300 (33.5)	15,150 (44)	16,000 (51)	16,400 (56)	15,600 (60)
60					11,800 (23.5)	12,700 (38.5)	13,550 (46.5)	13,950 (52.5)	14,100 (56.5)
65						10,700 (31.5)	11,550 (41.5)	11,950 (48.5)	12,300 (53.5)
70						9010 (22.5)	9920 (36)	10,250 (44)	10,650 (50)
75							8510 (29.5)	8890 (39.5)	9250 (46)
80							7260 (21)	7690 (34.5)	8050 (42.5)
85								6620 (28.5)	7010 (38)
90								5630 (20)	6100 (33)
95									5240 (27)
100									4480 (19.5)
Minimum boom angle (°) for indicated length (no load)									0
Maximum boom length (ft) at 0° boom angle (no load)									110

NOTE: () Boom angles are in degrees.
 #LMI operating code. Refer to LMI manual for operating instructions.
 *This capacity is based on maximum boom angle.

Lifting capacities at zero degree boom angle									
Boom angle	Main boom length in feet								
	36	40	50	**60	70	80	90	100	110
0°	30,350 (30.1)	25,700 (34.2)	17,950 (44.2)	13,050 (54.6)	10,050 (64.2)	7790 (74.2)	6300 (84.2)	4900 (94.2)	3900 (104.2)

NOTE: () Reference radii in feet. 80039604
 ** Boom length is with inner-mid fully extended and outer-mid & fly fully retracted.

THIS CHART IS ONLY A GUIDE AND SHOULD NOT BE USED TO OPERATE THE CRANE.

Load chart



Radius in feet	33 ft LENGTH			56 ft LENGTH		
	0° OFFSET	25° OFFSET	45° OFFSET	0° OFFSET	25° OFFSET	45° OFFSET
	#0021	#0022	#0023	#0041	#0042	#0043
30	12,900 (78)					
35	12,900 (76.5)			*8330 (78)		
40	12,900 (74.5)	*10,850 (78)		8330 (77.5)		
45	12,900 (72)	10,450 (76.5)	*7410 (78)	8330 (76)		
50	12,100 (70)	10,000 (74.5)	7200 (77.5)	8330 (74)		
55	11,100 (68)	9220 (72.5)	6990 (75.5)	8250 (72)	*5300 (78)	
60	10,100 (65.5)	8550 (70)	6800 (73)	7540 (70.5)	5140 (77.5)	
65	9130 (63.5)	7930 (67.5)	6650 (70.5)	7160 (68.5)	5100 (75.5)	*3860 (78)
70	8460 (61)	7380 (65.5)	6490 (68)	6820 (66.5)	5100 (73.5)	3790 (77.5)
75	7840 (58.5)	6900 (63)	6370 (65.5)	6300 (64.5)	4800 (71.5)	3660 (75.5)
80	7230 (56)	6470 (60.5)	6110 (63)	5810 (62.5)	4580 (69.5)	3550 (73)
85	6690 (53.5)	6070 (58)	5780 (60)	5370 (60.5)	4470 (67)	3,450 (71)
90	6,140 (51)	5720 (55.5)	5480 (57.5)	4980 (58.5)	4330 (65)	3410 (68.5)
95	5670 (48.5)	5400 (52.5)	5200 (54.5)	4,630 (56.5)	4070 (63)	3,300 (66.5)
100	5150 (45.5)	5100 (49.5)	4950 (51.5)	4320 (54)	3830 (60.5)	3260 (64)
105	4650 (42.5)	4760 (46.5)	4650 (48)	4040 (52)	3620 (58.5)	3220 (61.5)
110	4,070 (39.5)	4430 (43)		3770 (49.5)	3410 (56)	3180 (59)
115	3540 (36)	3930 (39.5)		3540 (47.5)	3230 (53.5)	3060 (56)
120	3060 (32)	3400 (35)		3310 (45)	3050 (50.5)	2940 (53)
125	2630 (27)	2920 (30)		3070 (42)	2890 (48)	2800 (50)
130	2230 (21.5)			2770 (39.5)	2730 (45)	
135				2400 (36.5)	2590 (41.5)	
140				2050 (33)	2410 (38)	
145				1720 (29)	2040 (33.5)	
150				1420 (24.5)		
Minimum boom angle (°) for indicated length (no load)	19	29	47	23	32	49
Maximum boom length (ft) at 0° boom angle (no load)	100			90		

NOTE: () Boom angles are in degrees.

80039607

#LMI operating code. Refer to LMI manual for operating instructions.

*This capacity is based upon maximum boom angle.

NOTES:

1. All capacities above the bold line are based on structural strength of boom extension.

2. 33 ft and 56 ft boom extension lengths may be used for single line lifting service.

3. For main boom lengths less than 110 ft with the boom extension erected, the rated loads are determined by boom angle. Use only the column which corresponds to the boom extension length and offset for which the machine is set up. For boom angles not shown, use the rating of the next lower boom angle.

4. **WARNING:** Operation of this machine with heavier loads than the capacities listed is strictly prohibited. Machine tipping with boom extension occurs rapidly and without advance warning.

5. Boom angle is the angle above or below horizontal of the longitudinal axis of the boom base section after lifting rated load.

6. Capacities listed are with outriggers fully extended and vertical jacks set only.

7. When lifting over the main boom nose with 33 ft or 56 ft extension erected, the outriggers must be fully extended or 50% extended (17 ft spread).

Load chart

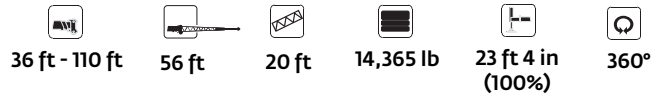

NOTES:

1. All capacities above the bold line are based on structural strength of boom extension.
2. The 56 ft boom extension length may be used for single line lifting service only.
3. For main boom lengths less than 110 ft with the boom extension erected, the rated loads are determined by boom angle. Use only the column which corresponds to the boom extension length and offset for which the machine is set up. For boom angles not shown, use rating of the next lower boom angle.
4. **WARNING:** Operation of this machine with heavier loads than the capacities listed is strictly prohibited. Machine tipping with boom extension occurs rapidly and without advance warning.
5. Boom angle is the angle above or below horizontal of the longitudinal axis of the boom base section after lifting rated load.
6. Capacities listed are with outriggers fully extended and vertical jacks set only.
7. When lifting over the main boom nose with 56 ft extension erected and 20 ft insert, the outriggers must be fully extended or 50% extended (17 ft spread).

Radius in feet	56 ft LENGTH		
	0° OFFSET	25° OFFSET	45° OFFSET
	#0084	#0085	#0086
40	*6300 (78)		
45	6300 (77.5)		
50	6000 (76.5)		
55	5990 (75)		
60	5980 (73)	*4840 (78)	
65	5510 (71.5)	4840 (77.5)	
70	5010 (70)	4440 (76)	
75	4560 (68)	4050 (74.5)	*3760 (78)
80	4170 (66.5)	3870 (72.5)	3460 (76.5)
85	3820 (64.5)	3570 (71)	3260 (74.5)
90	3520 (63)	3320 (69)	2960 (72.5)
95	3220 (61)	3070 (67)	2770 (70.5)
100	2980 (59)	2880 (65.5)	2570 (68.5)
105	2780 (57.5)	2680 (63.5)	2460 (66.5)
110	2530 (55.5)	2480 (61.5)	2340 (64.5)
115	2340 (53.5)	2280 (59.5)	2200 (62)
120	2190 (51.5)	2140 (57.5)	2050 (60)
125	2000 (49.5)	1990 (55)	1910 (57.5)
130	1850 (47.5)	1850 (53)	1810 (55)
135	1720 (45)	1750 (50.5)	1670 (52.5)
140	1610 (43)	1610 (48)	
145		1520 (45)	
150		1370 (42.5)	
Minimum boom angle (°) for indicated length (no load)	42	41	50
Maximum boom length (ft) at 0° boom angle (no load)	70		

80039609A

NOTE: () Boom angles are in degrees.
 #LMI operating code. Refer to LMI manual for operating instructions.
 *This capacity is based upon maximum boom angle.

THIS CHART IS ONLY A GUIDE AND SHOULD NOT BE USED TO OPERATE THE CRANE.

Load chart

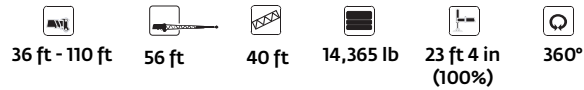

Radius in feet	56 ft LENGTH		
	#0084	#0085	#0086
	0° OFFSET	25° OFFSET	45° OFFSET
50	4510 (78)		
55	4210 (77)		
60	3910 (75.5)		
65	3710 (74)		
70	3410 (72.5)	*3710 (78)	
75	3220 (71)	3420 (76.5)	
80	2820 (69.5)	3120 (75)	
85	2520 (68)	2820 (73.5)	2730 (77.5)
90	2320 (66.5)	2620 (72)	2530 (75.5)
95	2030 (65)	2330 (70.5)	2340 (74)
100	1830 (63)	2130 (68.5)	2140 (72)
105	1630 (61.5)	1930 (67)	1940 (70.5)
110	1440 (60)	1730 (65.5)	1740 (68.5)
115	1240 (58.5)	1540 (63.5)	1550 (66.5)
120	1140 (56.5)	1340 (62)	1450 (64.5)
125		1240 (60)	1260 (62.5)
130		1050 (58)	1160 (60.5)
No Load Stability Data			
Min. boom angle (°) for indicated length	55	57	59
Max. boom length (ft) at 0° boom angle	40		

80039614A

NOTE: () Boom angles are in degrees.
 *This capacity is based upon maximum boom angle.
 #LMI operating code. Refer to LMI manual for instructions.

NOTES:

- All capacities above the bold line are based on structural strength of boom extension.
- The 56 ft boom extension length may be used for single line lifting service only.
- For main boom lengths less than 110 ft with the boom extension erected, the rated loads are determined by boom angle. Use only the column which corresponds to the boom extension length and offset for which the machine is set up. For boom angles not shown, use rating of the next lower boom angle.
- WARNING:** Operation of this machine with heavier loads than the capacities listed is strictly prohibited. Machine tipping with boom extension occurs rapidly and without advance warning.
- Boom angle is the angle above or below horizontal of the longitudinal axis of the boom base section after lifting rated load.
- Capacities listed are with outriggers fully extended and vertical jacks set only.
- When lifting over the main boom nose with 56 ft extension erected and 40 ft insert, the outriggers must be fully extended or 50% extended (17 ft spread).

Load charts

36 ft - 110 ft
 14,365 lb
 Pick and carry up to 2.5 mph 29.5 x 25 tires
 Over front

Radius in feet	#9006				
	Main boom length in feet				
	36	40	50	*60	70
10	47,200 (69.5)	44,000 (71.5)	34,000 (75.5)		
12	43,450 (66)	42,500 (68.5)	34,000 (73)	28,500 (76.5)	
15	35,900 (60)	35,200 (63.5)	34,000 (69.5)	28,500 (73.5)	21,350 (75.5)
20	27,000 (50)	26,650 (55)	26,300 (63)	26,500 (68)	21,350 (71.5)
25	20,750 (36.5)	20,550 (44.5)	20,500 (56)	20,550 (63)	21,300 (67)
30	16,150 (11.5)	16,100 (31.5)	16,200 (48.5)	16,200 (57)	17,000 (62.5)
35			12,850 (39.5)	12,850 (51)	13,750 (57.5)
40			9550 (28)	9970 (44)	10,950 (52)
45				7470 (36)	8470 (46.5)
50				5550 (26)	6540 (40)
55					5010 (33)
60					3760 (23)
Minimum boom angle (°) for indicated length (no load)					0
Maximum boom length (ft) at 0° boom angle (no load)					70

NOTE: () Reference boom angles in degrees.

Lifting capacities at zero degree boom angle					
Boom angle	Main boom length in feet				
	36	40	50	*60	70
0°	16,100 (30.1)	12,950 (34.2)	7,390 (44.2)	4,140 (54.6)	2,880 (64.2)

Note: () Reference radii in feet 80039613

#LMI operating code. Refer to LMI manual for instructions.

*60 ft. boom length is with inner-mid extended and outer-mid & fly retracted.

NOTES TO ALL RUBBER CAPACITY CHARTS:

- Capacities are in pounds and do not exceed 75% of tipping loads as determined by test in accordance with SAE J765.
- Capacities are applicable to machines equipped with 29.5 x 25 (28 or 34 ply General/Titan, Denman Rock Plus, Denman Broadway and Advance bias plus ply) tires at 65 psi cold inflation pressure.
- Capacities appearing above the bold line are based on structural strength and tipping should not be relied upon as a capacity limitation.
- Capacities are applicable only with machine on firm level surface.

36 ft - 110 ft
 14,365 lb
 Creep speed
 Over front

Radius in feet	#9030				
	Main boom length in feet				
	36	40	50	*60	70
10	47,200 (69.5)	44,000 (71.5)	34,000 (75.5)		
12	47,200 (66)	44,000 (68.5)	34,000 (73)	28,500 (76.5)	
15	43,250 (60)	42,500 (63.5)	34,000 (69.5)	28,500 (73.5)	21,350 (75.5)
20	32,950 (50)	32,600 (55)	32,250 (63)	28,500 (68)	21,350 (71.5)
25	25,450 (36.5)	24,850 (44.5)	25,250 (56)	25,250 (63)	21,350 (67)
30	17,850 (11.5)	17,250 (31.5)	17,800 (48.5)	18,050 (57)	19,000 (62.5)
35			12,950 (39.5)	13,300 (51)	14,300 (57.5)
40			9550 (28)	9970 (44)	10,950 (52)
45				7470 (36)	8470 (46.5)
50				5550 (26)	6540 (40)
55					5010 (33)
60					3760 (23)
Minimum boom angle (°) for indicated length (no load)					0
Maximum boom length (ft) at 0° boom angle (no load)					70

NOTE: () Reference boom angles in degrees.

Lifting capacities at zero degree boom angle					
Boom angle	Main boom length in feet				
	36	40	50	*60	70
0°	17,750 (30.1)	12,950 (34.2)	7,390 (44.2)	4,140 (54.6)	2,880 (64.2)

Note: () Reference radii in feet 80039612

#LMI operating code. Refer to LMI manual for instructions.

*60 ft. boom length is with inner-mid extended and outer-mid & fly retracted.

- On rubber lifting with boom extensions not permitted.
- For pick and carry operation, boom must be centered over front of machine, mechanical swing lock engaged and load restrained from swinging.
- Axle lockouts must be functioning when lifting on rubber.
- All lifting depends on proper tire inflation, capacity and condition. Capacities must be reduced for lower tire inflation pressures. See lifting capacity chart for tire used. Damaged tires are hazardous to safe operation of crane.
- Creep - not over 200 ft of movement in any 30 minute period and not exceeding 1 mph.

THIS CHART IS ONLY A GUIDE AND SHOULD NOT BE USED TO OPERATE THE CRANE.

The individual crane's load chart, operating instructions and other instructional plates must be read and understood prior to operating the crane

Load handling

Weight reductions for load handling devices		
33 ft - 56 ft : Folding boom extension:		
	Without block or ball	With 355 lb overhaul ball
*33 ft extension (erected)	3850 lb	5980 lb
*56 ft extension (erected)	8620 lb	12,170 lb
Folding extension with 20 ft insert:		
*33 ft extension (erected)	7480 lb	10,370 lb
*56 ft extension (erected)	13,320 lb	17,740 lb
Folding extension with 40 ft insert:		
*33 ft extension (erected)	9990 lb	12,360 lb
*56 ft extension (erected)	14,610 lb	17,730 lb
*Reduction of main boom capacities (no deduct required for stowed boom extension).		
Auxiliary boom nose:		
	130 lb	
Hookblocks and headache balls:		
65 USt, 5-sheave	1280 lb +	
8.3 USt, overhaul ball	355 lb +	

+Refer to rating plate for actual weight

When lifting over swingaway and/or jib combinations, deduct total weight of all load handling devices reeved over main boom nose directly from swingaway or jib capacity.

NOTE: All load handling devices and boom attachments are considered part of the load and suitable allowances **MUST BE MADE** for their combined weights. Weights are for Grove furnished equipment.

Line pulls and reeving information			
Hoists	Cable specs	Permissible line pulls	Nominal cable length
Main	19 mm (3/4 in) 6 x 37 class, EIPS, IWRC Special Flexible Min. breaking strength 58,800 lb	16,800 lb	500 ft
Main and auxiliary	19 mm (3/4 in) 35x7 Class Rotation Resistant (non-rotating) Min. breaking strength 85,800 lb	16,800 lb	500 ft

The approximate weight of 3/4 in wire rope is 1.5 lb/ft.







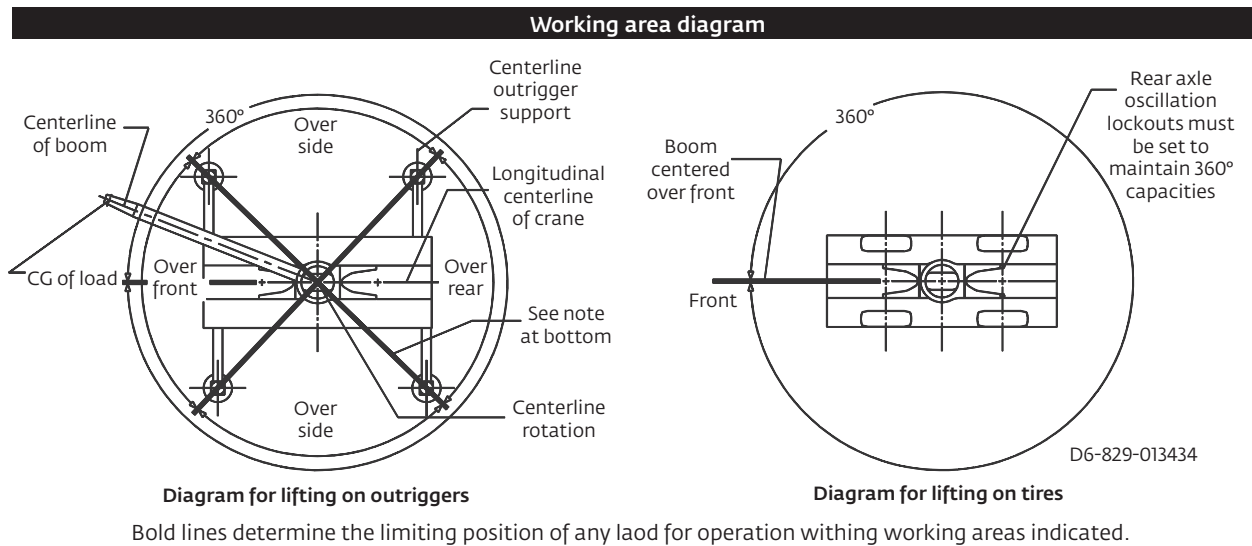





















Hoist performance				
Wire rope layer	Hoist line pulls two-speed hoist		Drum rope capacity (ft)	
	Low available lb*	High available lb*	Layer	Total
1	18,134	9067	101	101
2	16,668	8334	110	211
3	15,420	7710	120	331
4	14,347	7174	129	460
5	13,413	6707	139	599
6	12,594	6297	149	748

*Max lifting capacity: 6x37 and 35x7 class = 16,800 lb

Tire inflation - PSI (BAR)			
Size (Front and Rear)	TRA Code	Lifting service, general travel and extended travel	
29.5 x 25 (28 or 34) General/Titan, Denman Broadway/Rock Plus	E-3	65 (4.5) See operator's manual for extended roading.)	



Symbols glossary

 Axles	 Drive	 Heavy duty jib	 Radius
 Boom	 Electrical system	 Hoist	 Rotation
 Boom elevation	 Engine	 Hookblock	 Speed
 Boom extension	 Extension	 Hydraulic system	 Steering
 Boom length	 Frame	 Insert	 Suspension
 Boom nose	 Fuel tank capacity	 Lights	 Swing
 Brakes	 Gear	 Oil	 Tires
 Cab	 Grade	 Outrigger controls	 Transmission
 Counterweight	 Height (no max)	 Outriggers	

THIS CHART IS ONLY A GUIDE AND SHOULD NOT BE USED TO OPERATE THE CRANE.

The individual crane's load chart, operating instructions and other instructional plates must be read and understood prior to operating the crane

Manitowoc Cranes

Regional headquarters

Americas

Manitowoc, Wisconsin, USA

Tel: +1 920 684 6621

Fax: +1 920 683 6277

Shady Grove, Pennsylvania, USA

Tel: +1 717 597 8121

Fax: +1 717 597 4062

Europe, Middle East, Africa

Ecully, France

Tel: +33 (0)4 72 18 20 20

Fax: +33 (0)4 72 18 20 00

China

Shanghai, China

Tel: +86 21 6457 0066

Fax: +86 21 6457 4955

Greater Asia-Pacific

Singapore

Tel: +65 6264 1188

Fax: +65 6862 4040

Regional offices

Americas

Brazil

Alphaville

Mexico

Monterrey

Chile

Santiago

Europe, Middle East,

Africa

Czech Republic

Netvorice

France

Baudemont

Cergy

Decines

Germany

Langenfeld

Hungary

Budapest

Italy

Lainate

Netherlands

Breda

Poland

Warsaw

Portugal

Baltar

Russia

Moscow

U.A.E.

Dubai

U.K.

Buckingham

China

Beijing

Chengdu

Guangzhou

Xian

Greater Asia-Pacific

Australia

Adelaide

Brisbane

Melbourne

Sydney

India

Calcutta

Chennai

Delhi

Hyderabad

Pune

Korea

Seoul

Philippines

Makati City

Singapore

Factories

Brazil

Alphaville

China

TaiAn

Zhangjiagang

France

Charlieu

Moulins

Germany

Wilhelmshaven

India

Pune

Italy

Niella Tanaro

Portugal

Baltar

Fânzeres

Slovakia

Saris

USA

Manitowoc

Port Washington

Shady Grove

This document is non-contractual. Constant improvement and engineering progress make it necessary that we reserve the right to make specification, equipment, and price changes without notice. Illustrations shown may include optional equipment and accessories and may not include all standard equipment.

**Cleveland Crane
& Shovel Sales, Inc.**

26781 Cannon Road

Cleveland, OH 44146

(440) 439-4749

www.craneandshovel.net