



Series 1400

product guide

features

- All New Design
- 127' Five-Section Boom
- 33 Ton Rating
- Self-lubricating "Easy Glide" Wear Pads
- Internal Anti-two-block



contents

Features	2
Mounting Configurations	3
Specifications	4
Capacities: With 30'-54' Jib Full Outrigger Span	5
Capacities: With 30'-54' Jib Midspan Outrigger	6
Accessories	7

features

Why Buy a National Series 1400?



*Product may be shown with optional equipment.

- **33-ton Rating** – The new 1400 is a 33-ton machine, a 10% increase in capacity over the Series 1300.
- **New 127-foot Five-section Boom** – The longest in its size range. The longer boom allows the operator to perform more lifts without the use of a jib, reducing setup time and improving efficiency. A 100-foot four-section boom or a 110-foot four-section boom is also available.
- **Overload Protection** – All National cranes are equipped with overload protection:
 - Load Moment Indicator (LMI) standard on all series 1400 machines.
 - LMI display and CPU are weatherproof.
 - LCD display is visible in full or low light.
 - All crane load lifting values are displayed simultaneously.
- **Self-lubricating “Easy glide” Boom Wear Pads** – The self-lubricating boom pads, standard on the 1400, reduce the conditions that cause boom chatter and vibration. The net result is smoother crane operation.
- **Internal Anti-two-block Wire** – This exclusive design, standard on the Series 1400, routes the wiring through the inside of the boom. No more snagging the wire on obstructions.
- **“H”-style Outriggers** – Two sets of “H”-style outriggers with 24’ 6” (7.47 m) span, with removable ball and socket aluminum foot pads. Independent controls located on each side of the crane - can be positioned at mid-span setting of 17’ (5.18 m).
- **Continuous Rotation/Glide Swing** – The series 1400 is supplied with continuous rotation standard, along with the “glide swing” feature - allowing free swing during rotation - and a manually applied foot brake. 375° non-continuous rotation is also available.
- **Adjustable Swing Speed** – Standard on the 1400. A control knob located on the swing motor brake release valve can be easily adjusted to the crane operator’s swing speed preference.
- **Oil Cooler** – Radiator mounted at boom rest with electric fan is standard, with an option for a heavy-duty cooler for high duty-cycle applications.
- **Heavier Duty Torsion Box** – The stronger standard torsion box improves rigidity, reduces truck frame flex and reduces the need for counterweight.
- **Speedy-reeve Boom Tip and Sheave Blocks** – These standard features simplify rigging changes by decreasing the time needed to change line reeving.
- **Pre-painted Components** – Painting crane components before assembly reduces the possibility of rust, improves serviceability and enhances the appearance of the machine.
- **Deluxe Operator’s Cab** – Rigid galvanized steel structure, well insulated, with ample safety glass for operator visibility and comfort. Multi-position seat with arm rest controls, ventilation fans, diesel heater, wipers. Optional air-conditioning is available. Optional open-seat control station in lieu of enclosed cab is available.
- **Improved Serviceability** –
 - Bearings on the boom extend and retract cables can be greased through access holes in the boom side plates.
 - Number of internal boom parts has been reduced, decreasing service time when rebuilding the machine.
- **New State-of-the-art Control Valve** – Provides smoother operation. The new design eliminates parts, reducing repair costs and improving the machine’s serviceability.
- **National Crane Is the Market Leader** – National is number one in the production of commercial truck-mounted boom trucks. National has many programs and people directly and indirectly involved to provide our customers reliable products.
 - National has the boom truck industry’s leading test program. Every structural part of the crane is cycle tested up to 60,000 cycles at full capacity. In addition to cycle testing, each model is subjected to state-of-the-art strain gauge testing that measures metal deformation as small as one one-millionth of an inch. The net result is that any weak areas are caught in test, not on job sites where costly downtime occurs.
 - All outrigger, lift and telescoping cylinders are manufactured by National Crane, so that the seals, packing glands, and end plates are traced for accurate shipment of replacement parts.
 - Parts are available for all National Crane machines, even if they are 35 years old.
 - National has a formalized quality program and is ISO 9001 approved.
- **You Expect National Crane to be a Quality Product That Will Provide Years of Service, and So Do We.**

- 33-ton (29.94-t) maximum capacity
- 171-ft (52.12-m) maximum vertical reach*
- 135-ft (41.15-m) maximum vertical hydraulic reach*
- Load Moment Indicator system (LMI)
- Proportional boom extension
- High performance planetary winch
- Heavy-duty triple pump hydraulics
- 99 Gallon(375L) hydraulic reservoir with 10 micron return filter.
- Maximum vertical reach is ground-level to boom tip height at maximum extension and angle with outriggers/stabilizers fully extended.

1400

mounting configuration

The mounting configuration shown is based on the Series 1400 with an 85% stability factor. The complete unit must be installed in accordance with factory requirements and a test performed to determine actual stability and counterweight requirements since individual truck chassis vary. If bare truck weights are not met, counterweight will be required. The front bumper stabilizer (SFO) is required for all installations. Chassis must be equipped with a front frame suitable for SFO addition. Contact factory for complete chassis specifications.

Working area	360°
Gross Axle Weight Rating Front.....	20,000 lb (9072 kg)*
Gross Axle Weight Rating Rear	34,000 lb (15 422 kg)*
Gross Vehicle Weight Rating	54,000 lb (24 494 kg)*
Wheelbase	Minimum 258 in (655 cm)
Cab to Axle/trunnion (CA/CT)	Minimum 180 in (457 cm)
After Frame (AF).....	.92 in (234 cm) minimum
Frame Section Modulus (SM), front axle to end of afterframe, w/110,000 PSI (758 MPa)	30 in ³ (492 cm ³)
Stability Weight, Front.....	9,000 lb (4082 kg) minimum**
Stability Weight, Rear	8,000 lb (3629 kg) minimum**
Estimated Average Final Weight.....	51,880 lb (23 585 kg)***

The diagram shows the 360° working area that can be achieved with the front stabilizer (standard on the Series 1400). The front stabilizer is required when extending the boom and lifting loads forward of the outriggers. A minimum of 10-in³ (164 cm³) section modulus at 110,000 psi (759 MPa) is required from the rear of the front spring hanger forward to the front stabilizer. Integral front frame extension recommended.

* Required to mount basic crane with 30-ft (9.15-m) jib option. Additional options or heavier bare chassis weights will require additional axles or a GVWR in excess of 54,000 lb (24 494 kg); in some states, special permits for overload are required.

** Estimated axle scale weights prior to installation of crane, stabilizers and subbase for 85% stability.

*** Includes basic crane without jib, 100-gal (379-L) fuel tank and two workers (300 lb, 136kg) in cab.

Note: Chassis preferred with extended front frame rails for SFO addition.

TRUCK REQUIREMENTS

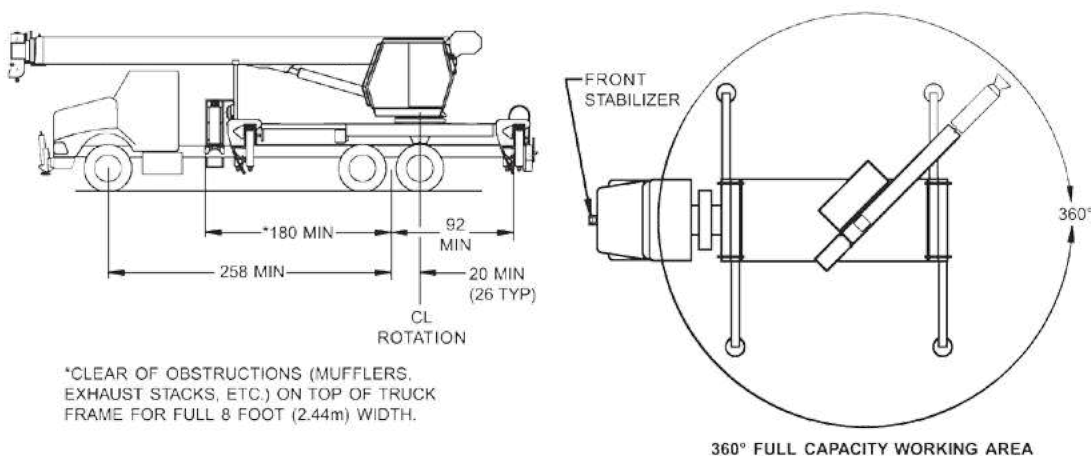

Notes:

- Gross Vehicle Weight Rating (GVWR) is dependent on all components of the vehicle (axles, tires, springs, frame, etc.) meeting manufacturers' recommendations; always specify GVWR when purchasing trucks.
- Diesel engines require a variable speed governor and energize-to-run fuel solenoid for smooth crane operation. Electronic fuel-injected engines are required.
- All mounting data is based on a National Series 1400 with the standard subbase and an 85 percent stability factor.
- The complete unit must be installed in accordance with factory requirements, and a test performed to determine actual stability and counterweight requirements per SAE J765; contact the factory for details.
- Transmission neutral safety interlock switch is required.

1400

specifications

Boom and Jib Combinations Data

Available in three basic models.

Model 14100 — Equipped with a 30 ft 10 in to 100 ft (9.40-30.49 m) four-section boom. This model can be equipped with a 30 ft (9.15 m) single-section jib or a 30-54 ft (9.15-16.46 m) two-section jib. Maximum tip height w/30ft (9.15 m) jib is 137 ft (41.77 m), while maximum tip height w/30-54 ft (9.15-16.46 m) jib is 161 ft (49.08 m).

30'10" - 100' (9.40-30.49 m) four-section boom



30'10" - 100' (9.40-30.49 m) four-section boom **14FJ30M** 30 ft (9.15 m) single-section jib



30'10" - 100' (9.40-30.49 m) four-section boom **14FJ54M** 30-54 ft (9.15-16.46 m) two-section jib



Model 14110 — Equipped with a 33 ft 4 in to 110 ft (10.16-33.53 m) four-section boom. This model can be equipped with a 30 ft (9.15 m) single section jib or a 30-54 ft (9.15-16.46 m) two-section jib. Maximum tip height w/30ft (9.15 m) jib is 147 ft (44.82 m), while maximum tip height w/54 ft (16.46 m) jib is 171 ft (52.13 m).

33'4" - 110' (10.16-33.53 m) four-section boom



33'4" - 110' (10.16-33.53 m) four-section boom **14FJ30M** 30 ft (9.15 m) single-section jib



33'4" - 110' (10.16-33.53 m) four-section boom **14FJ54M** 30-54 ft (9.15-16.46 m) two-section jib



Model 14127 — Equipped with a 31 ft 7 in to 127 ft (9.63-38.72 m) five-section boom. This model can be equipped with a 30 ft (9.15 m) single-section jib. Maximum tip height w/ 30 ft (9.15 m) jib is 164 ft (50.00 m).

31'7" - 127' (9.63-38.72 m) five-section boom











31'7" - 127' (9.63-38.72 m) five-section boom **14FJ30M** 30 ft (9.15 m) single-section jib



Note: maximum tip height is measured with outriggers/stabilizers fully extended.

1400 Winch Data

- Do not deadhead line block against boom tip when extending boom.
- Keep at least 3 wraps of load line on drum at all times.
- Use only 5/8" diameter rotation-resistant cable with 45,400 pounds breaking strength on this machine.

		1 Part Line	2 Part Line	3 Part Line	4 Part Line	5 Part Line	6 Part Line	7 Part Line	8 Part Line	
										
MAXIMUM BOOM LENGTH AT MAXIMUM ELEVATION WITH RIGGING SHOWN WITH LOAD BLOCK AT GROUND LEVEL		110' boom w/ 54' jib	110'	83'	64'	52'	43'	36'	31'	
Winch	Cable Supplied	Average Breaking Strength	Lift and Speed	Lift and Speed	Lift and Speed	Lift and Speed	Lift and Speed	Lift and Speed	Lift and Speed	
Standard Planetary Winch Low Speed	5/8" Diameter Rotation Resistant	45,400 lb (20,593 kg)	9,000 lb (4,082 kg) 170 fpm (52 m/min)	18,000 lb (8,165 kg) 85 fpm (26 m/min)	27,000 lb (12,247 kg) 57 fpm (17 m/min)	36,000 lb (16,329 kg) 43 fpm (13 m/min)	45,000 lb (20,412 kg) 34 fpm (10 m/min)	54,000 lb (24,494 kg) 28 fpm (9 m/min)	63,000 lb (28,576 kg) 24 fpm (7 m/min)	66,000 lb (29,937 kg) 21 fpm (6 m/min)
Standard Planetary Winch High Speed	5/8" Diameter Rotation Resistant	45,400 lb (20,593 kg)	4,400 lb (1,996 kg) 340 fpm (104 m/min)	8,800 lb (3,992 kg) 170 fpm (52 m/min)	13,200 lb (5,987 kg) 113 fpm (34 m/min)	17,600 lb (7,983 kg) 85 fpm (26 m/min)	22,000 lb (9,979 kg) 68 fpm (21 m/min)	26,400 lb (11,975 kg) 57 fpm (17 m/min)	30,800 lb (13,971 kg) 49 fpm (15 m/min)	35,200 lb (15,967 kg) 43 fpm (13 m/min)

All winch pulls and speeds in this chart are shown on the fourth layer. Winch line pulls would increase on the first, second and third layers. Winch line speed would decrease on the first, second and third layers. Winch line pulls may be limited by the winch capacity or the ANSI S13 cable safety factor. These are shown below.

Winch	Full Drum Pull	Allowable Cable Pull
Standard planetary	4,400 lb. (1,995 kg) (high speed) 9,000 lb. (4,082 kg) (low speed)	9,080 lb. (4,119 kg)

Block Type	Rating	Weight
Aux. Boom Head		100 lb (45 kg)
Downhaul Weight	5 Ton (4,530)	160 lb (82 kg)
1 Sheave Block	15 Ton (13,600)	375 lb (170 kg)
2 Sheave Block	25 Ton (22,670)	640 lb (290 kg)
3 Sheave Block	35 Ton (31,740)	870 lb (395 kg)
4 Sheave Block	38 Ton (32,655)	970 lb (440 kg)

1400

capacities

Load Rating Chart: Series 14110 with 30'-54' Jib / Fullspan Outrigger 24'6"

Other Series 1400 Load Rating Charts are available. National will send you a chart on request – or you may secure needed load rating information through your nearest National dealer.

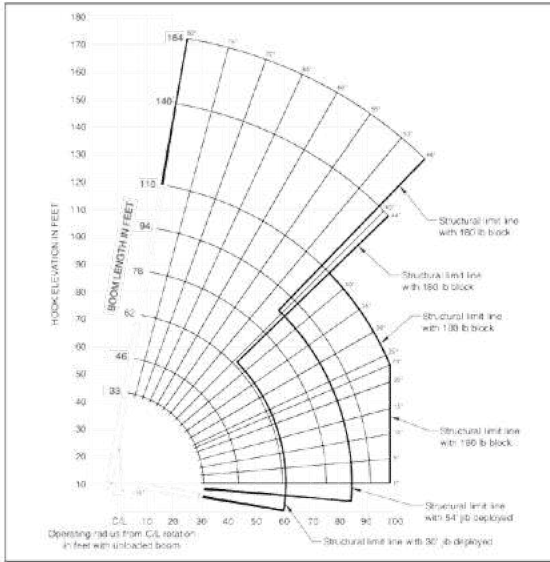

CAUTION:

- Do not operate crane booms, jib extensions, any accessories or loads within 10 ft (3m) of live power lines or other conductors of electricity.
- Jib and boom capacities shown are maximum for each section.
- Do not exceed capacities at reduced radii.
- Load ratings shown on the appropriate charts are maximum allowable loads with the crane mounted on a factory-approved truck and all outriggers at either full span or at mid span range and set on a firm level surface so that the crane is level and all tires are suspended.
- Always level the crane with the level indicator located on the crane.
- The operator must reduce load to allow for factors such as wind, ground conditions, operating speeds and their effects on freely suspended loads.
- Overloading this crane may cause structural collapse or instability.
- Weights on any accessories attached to the boom or loadline must be deducted from the load chart capacities.
- Do not exceed jib capabilities at any reduced boom lengths.
- Do not deadhead lineblock against boom tip when extending boom or winching up.
- Keep at least three wraps of loadline on drum at all times.
- Use only specified cable with this machine.

**SERIES 14110
WITH
30'-54' JIB
FULL SPAN
OUTRIGGER 24'6"**

NOTE:

1. Operate with jib by radius when main boom is fully extended. If necessary increase boom angle to maintain loaded radius.
2. Operate with jib by boom angle when main boom is not fully extended. Do not exceed rated jib capacities at any reduced boom lengths.

**LOADLINE EQUIPMENT
DEDUCT (lb.)**

Downhaul weight.....	180
One sheave block.....	375
Two sheave block.....	640
Three sheave block.....	870
Four sheave block.....	970

Load Rating: Series 14110 with 30'-54' Jib / Fullspan Outrigger 24'6"

33 TO 110 FOOT BOOM RATED LOADS WITHOUT JIB

LOAD RADIUS (ft)	LOADED BOOM ANGLE	33 ft BOOM (lb)	LOADED BOOM ANGLE	A 48 ft BOOM (lb)	LOADED BOOM ANGLE	B 62 ft BOOM (lb)	LOADED BOOM ANGLE	C 78 ft BOOM (lb)	LOADED BOOM ANGLE	D 94 ft BOOM (lb)	LOADED BOOM ANGLE	110 ft BOOM (lb)	
6	76.7	66,000											
8	72.8	51,700											
10	68.9	42,200	76	37,000									
12	64.9	38,400	73.4	33,400	78.2	26,900							
15	58.6	32,200	69.3	28,000	75.6	24,900	79.4	22,600					
20	48.5	23,900	62.2	21,650	70.2	19,300	74.8	17,900	73.2	14,100			
25	33.3	17,000	54.4	17,800	64.9	16,050	71	14,550	75.1	12,400	77.4	9,200	
30			46.2	15,100	59.8	13,600	67	12,300	71.9	11,200	75.1	8,700	
35			36.3	12,750	54	12,050	63	10,600	69.5	9,750	72.5	8,000	
40			22.9	10,100	47.8	10,450	58.7	9,300	65.5	8,550	69.6	7,200	
45					41.6	8,750	54.5	7,800	61.9	7,350	67	6,400	
50					33.9	7,200	49.7	6,900	58.2	6,250	63.9	5,700	
55					25.6	5,600	44.5	6,000	54.4	5,500	60.8	4,700	
60							38.6	4,500	50.5	4,800	57.6	4,000	
65							31.9	4,000	46.3	4,200	54.4	3,400	
70							23.3	3,250	41.7	3,450	51	2,700	
75								8.7	2,500	36.6	2,750	47.4	2,300
80										30.7	2,250	43.6	1,800
85										23.5	1,750	39.3	1,200
90										12.5	1,250	34.7	1,000
95												29.6	800
100												23.3	600
0		12,000	0	7,500	0	4,500	0	2,500	0	1,000			

LOAD RADIUS (ft)	LOADED BOOM ANGLE	30 ft JIB (lb)	LOADED BOOM ANGLE	54 ft JIB (lb)
30	79.1	5,050		
35	77.4	5,000	79.5	2,650
40	75.8	4,950	78.1	2,600
45	74.7	4,700	77.6	2,500
50	71.6	4,300	75	2,400
55	69.5	4,000	73.2	2,300
60	67.3	3,700	71.5	2,200
65	65.1	3,400	69.8	2,100
70	62.9	3,150	67.8	2,000
75	60.5	2,850	66	1,850
80	58	2,500	64.1	1,750
85	55.5	2,000	62.2	1,600
90	52.8	1,600	60.2	1,500
95	50	1,200	58	1,400
100	47.1	850	55.8	1,300
105	43.9	500	53.6	1,200
110			51.2	1,000
115			48.7	750
120			46.1	500

*SHADED AREAS ARE STRUCTURALLY LIMITED CAPACITIES

1400

THIS CHART IS ONLY A GUIDE AND SHOULD NOT BE USED TO OPERATE THE CRANE. The individual crane's load chart, operating instructions and other instructional plates must be read and understood prior to operating the crane.



capacities

Load Rating Chart: Series 14110 with 30'-54' Jib / Midspan Outrigger 17'

Other Series 1400 Load Rating Charts are available. National will send you a chart on request – or you may secure needed load rating information through your nearest National dealer.

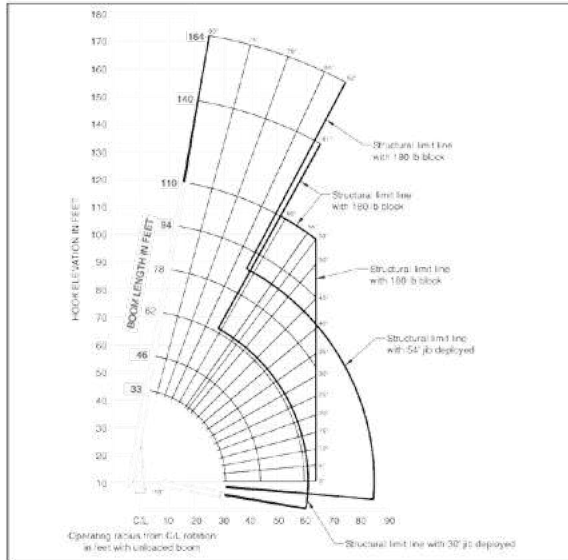

CAUTION:

- Do not operate crane booms, jib extensions, any accessories or loads within 10 ft (3m) of live power lines or other conductors of electricity.
- Jib and boom capacities shown are maximum for each section.
- Do not exceed capacities at reduced radii.
- Load ratings shown on the load rating charts are maximum allowable loads with the outriggers properly extended and the outrigger lock pins engaged on a firm, level surface and the crane leveled and mounted on a factory recommended truck.
- Always level the crane with the level indicator located on the crane.
- The operator must reduce load to allow for factors such as wind, ground conditions, operating speeds and their effects on freely suspended loads.
- Overloading this crane may cause structural collapse or instability.
- Weights on any accessories attached to the boom or loadline must be deducted from the load chart capacities.
- Do not exceed jib capabilities at any reduced boom lengths.
- Do not deadhead lineblock against boom tip when extending boom or winching up.
- Keep at least three wraps of loadline on drum at all times.
- Use only specified cable with this machine.

**SERIES 14110
WITH
30'-54' JIB
MIDSPAN
OUTRIGGER 17'**

**LOADLINE EQUIPMENT
DEDUCT (lb.)**

- Downhaul weight.....180
- One sheave block.....375
- Two sheave block.....640
- Three sheave block.....870
- Four sheave block.....970

Load Rating Chart: Series 14110 with 30'-54' Jib / Midspan Outrigger 17'

33 TO 110 FOOT BOOM RATED LOADS WITHOUT JIB

LOAD RADIUS (ft)	LOADED BOOM ANGLE	33 ft BOOM (lb)	40 ft BOOM (lb)	46 ft BOOM (lb)	54 ft BOOM (lb)	62 ft BOOM (lb)	70 ft BOOM (lb)	78 ft BOOM (lb)	84 ft BOOM (lb)	94 ft BOOM (lb)	110 ft BOOM (lb)	
6	76.7	66,000										
8	72.8	51,700										
10	68.9	42,200	76	37,000								
12	64.9	36,400	73.4	33,400	78.2	26,900						
15	58.6	32,200	69.3	28,000	75.6	24,900	75.4	22,800				
20	46.9	18,500	62.2	21,850	70.2	19,300	74.8	17,900	78.2	14,100		
25	32.3	11,000	54.4	14,000	64.7	12,800	70.8	13,200	75.1	12,400	9,200	
30			45.3	9,500	59.8	8,600	67	9,100	71.7	8,200	75.1	8,700
35			36.9	7,000	54	6,200	62.8	6,400	68.2	6,800	72.2	7,000
40			29.9	4,800	47.8	4,500	58.2	4,600	64.7	5,000	69	5,200
45					40.9	3,200	54	3,400	61	3,600	65.9	3,900
50					33.1	2,100	48.8	2,500	57.4	2,600	62.9	2,800
55					22.8	1,300	43.5	1,700	53.4	1,900	59.9	2,000
60							37.7	1,100	48.4	1,300	56.6	1,400
65								31	600	45.1	750	900
70												
75												
80												
85												
90												
95												
100												
0		7,000	0	3,600	0	500						

30 TO 54 FOOT JIB RATED LOADS				
LOAD RADIUS (ft)	LOADED BOOM ANGLE	30 ft JIB (lb)	LOADED BOOM ANGLE	54 ft JIB (lb)
30	79.1	5,050		
35	77.4	5,000	79.5	2,650
40	75.6	4,950	78.1	2,600
45	73.4	4,300	77.6	2,500
50	70.9	3,250	75	2,400
55	68.4	2,400	73.2	2,300
60	65.9	1,750	71.4	2,200
65	63.4	1,150	69	1,900
70	60.8	700	66.7	1,450
75			64.5	1,050
80			62.1	650
85				
90				
95				
100				
105				
110				
115				
120				

*SHADED AREAS ARE STRUCTURALLY LIMITED CAPACITIES

THIS CHART IS ONLY A GUIDE AND SHOULD NOT BE USED TO OPERATE THE CRANE. The individual crane's load chart, operating instructions and other instructional plates must be read and understood prior to operating the crane.

1400



accessories

Radio Remote Controls –

Eliminate the handling and maintenance concerns that accompany cabled remotes. Operate to a range of about 250 feet (76 m), varying with conditions.

- **Model NB4R**

One-Person Basket –

Strong but lightweight steel basket with 300-lb. (139-kg) capacity, gravity hung with swing lock and full body harness.

- **Model B1-S**
- **Model 2B1-S** (for dual locking baskets)

Heavy-duty Personnel Basket –

1,200-lb. (544-kg) capacity steel basket with safety loops for four passengers. Gravity leveling 72- x 42-inch (183- x 107-cm) platform. Fast attachment and secure locking systems. Load chart must show 2,300 lb. (1043 kg) minimum to operate this accessory.

- **Model BSA-1**
- **Model BSA-R1** (provides rotation)

Air Conditioning –

Hydraulically driven air conditioning compressor with in-cab cool air outlets. External condenser on side of turret. Requires 130+ amp chassis alternator.

- **Model AC**

Dimensions Specifications

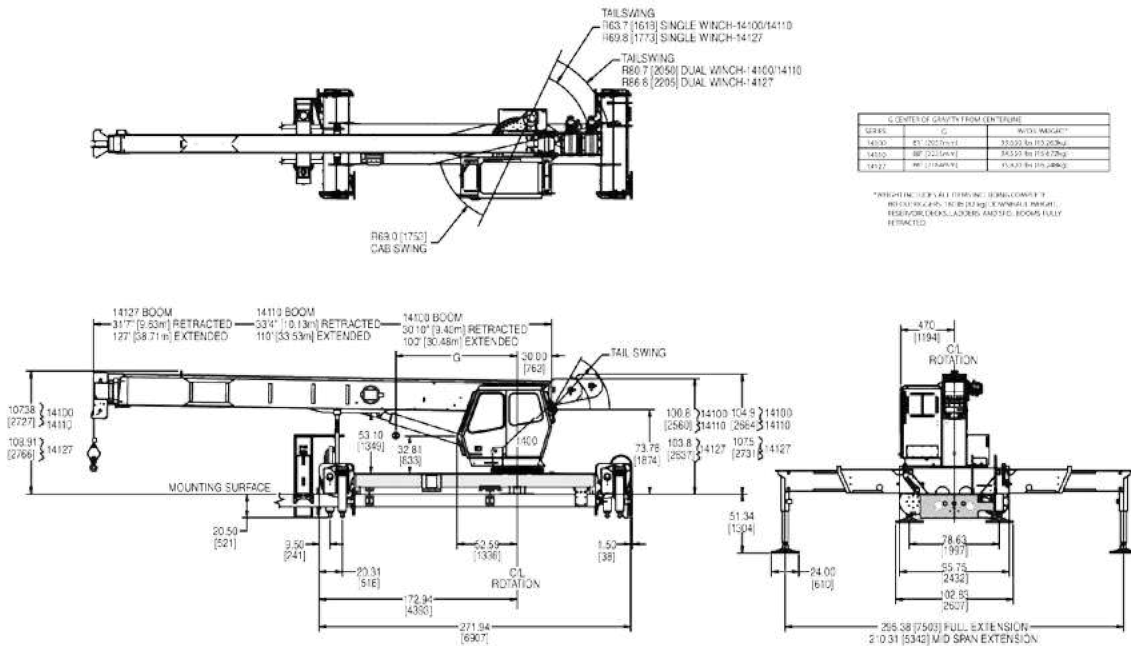

1400

THIS CHART IS ONLY A GUIDE AND SHOULD NOT BE USED TO OPERATE THE CRANE. The individual crane's load chart, operating instructions and other instructional plates must be read and understood prior to operating the crane.



Manitowoc Crane Group - Americas
 Manitowoc, Wisconsin Facility
 Tel: [Int + 001] 920 684 6621
 Fax: [Int + 001] 920 683 6277
 Piquette, Pennsylvania Facility
 Tel: [Int + 001] 717 597 8121
 [Int + 001] 717 597 4062

Manitowoc Crane Group - EMEA
 Europe Middle East & Africa
 Tel: [Int + 33] (0) 191 565 6281
 Fax: [Int + 33] (0) 4 72 18 20 20

Manitowoc Crane Group - UK
 Europe Middle East & Africa
 Tel: [Int + 44] (0) 191 565 6281
 Fax: [Int + 44] (0) 191 564 0542

Manitowoc Crane Group - Germany
 (Sales, Parts & Service)
 Tel: [Int + 49] (0) 2173 8909 0
 Fax: [Int + 49] (0) 2173 8909-30

Manitowoc Crane Group - France
 France & Africa (Sales, Parts & Service)
 Tel: [Int + 33] (0) 1 303 13150
 Fax: [Int + 33] (0) 1 303 86085

Manitowoc Crane Group - Netherlands
 (Sales, Parts & Service)
 Tel: [Int + 31] (0) 76 578 39 99
 Fax: [Int + 31] (0) 76 578 39 78

Manitowoc Crane Group - Italy
 Italy & Southern Europe (Sales, Parts & Service)
 Tel: [Int + 39] (0) 331 49 33 11
 Fax: [Int + 39] (0) 331 49 33 30

Manitowoc Crane Group - Portugal
 Portugal & Spain (Sales, Parts & Service)
 Tel: [Int + 351] (0) 22 968 08 89
 Fax: [Int + 351] (0) 22 968 08 97

Manitowoc Crane Group - Singapore
 Asia/Pacific excl China (Sales, Parts & Service)
 Tel: [Int + 65] 6861 1733
 Fax: [Int + 65] 6862 4040 / 4142

Manitowoc Crane Group - Shanghai
 China (Sales, Parts & Service)
 Tel: [Int + 86] (0) 21 64955555
 Fax: [Int + 86] (0) 2164852038

Manitowoc Crane Group - Beijing
 China (Sales, Parts & Service)
 Tel: [Int + 86] (0) 10 846 71690
 Fax: [Int + 86] (0) 10 646 71691

Manitowoc Crane Group - Middle East
 Sales
 Tel: [Int + 971] (0) 4 348 4478
 Fax: [Int + 971] (0) 4 348 4478
 (Parts & Service)
 Tel: [Int + 973] (0) 9 860 899
 Fax: [Int + 973] (0) 2 707 740

Distributed By:

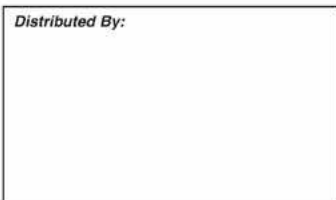

Manitowoc
 Crane CARE



www.manitowoccrane.com

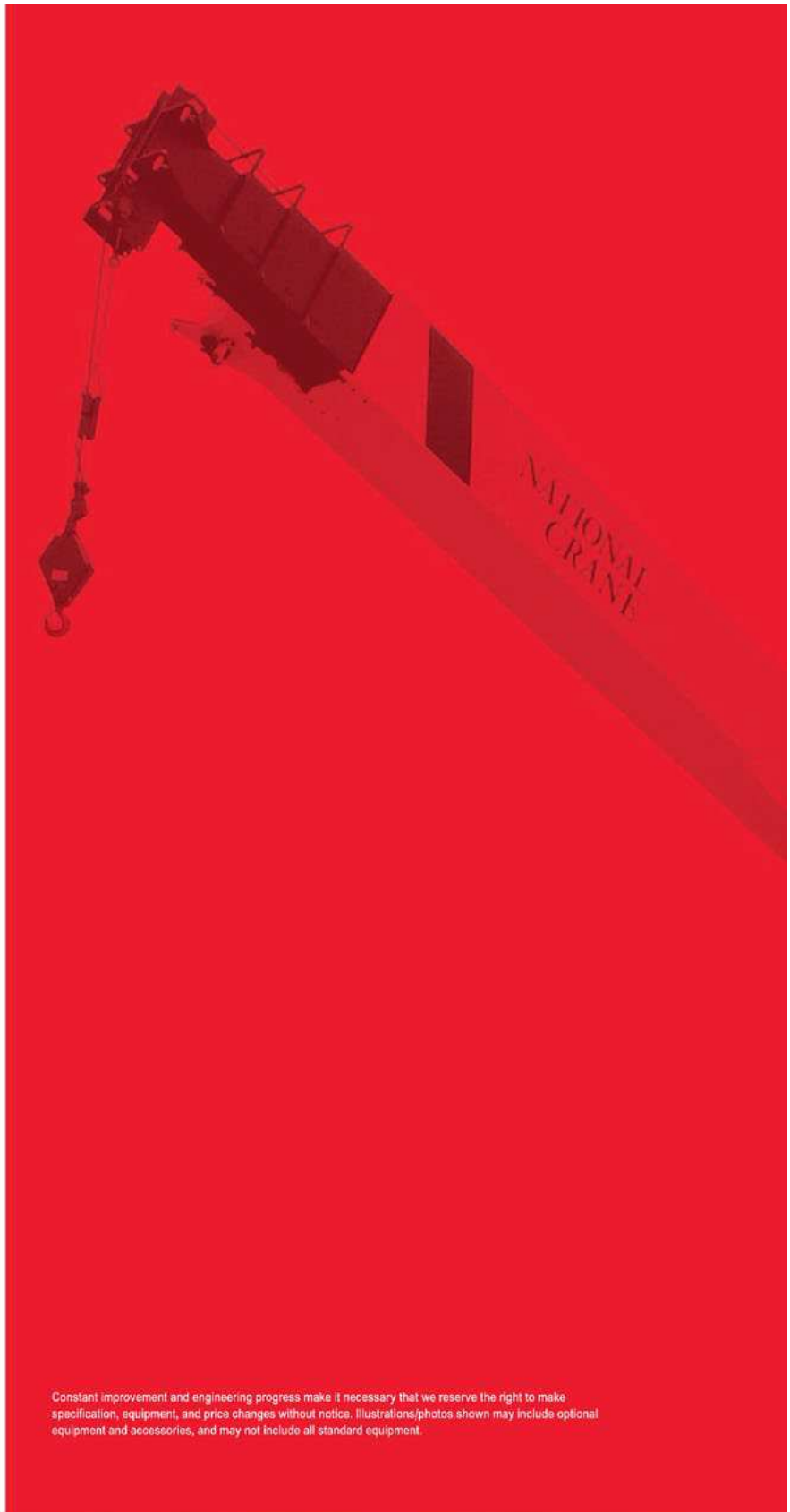

Constant improvement and engineering progress make it necessary that we reserve the right to make specification, equipment, and price changes without notice. Illustrations/photos shown may include optional equipment and accessories, and may not include all standard equipment.