

# 汽车起重机 / Truck Crane

## QY55KA



55t



43.5 m



58.1 m



## 目录 Content

目录 Content	
尺寸参数 Dimensions	4
技术规格 Product Specifications	5-8
重量/作业速度 Weight / Working speeds	9
臂架组合方案 Boom / Jib combinations	10
主臂 Boom	11-15
副臂 Jib	16-17
符号标识 Description of symbols	18
主要技术参数表 Transportation plan	19-20
注意事项 Notes	21

# 尺寸参数 Dimensions

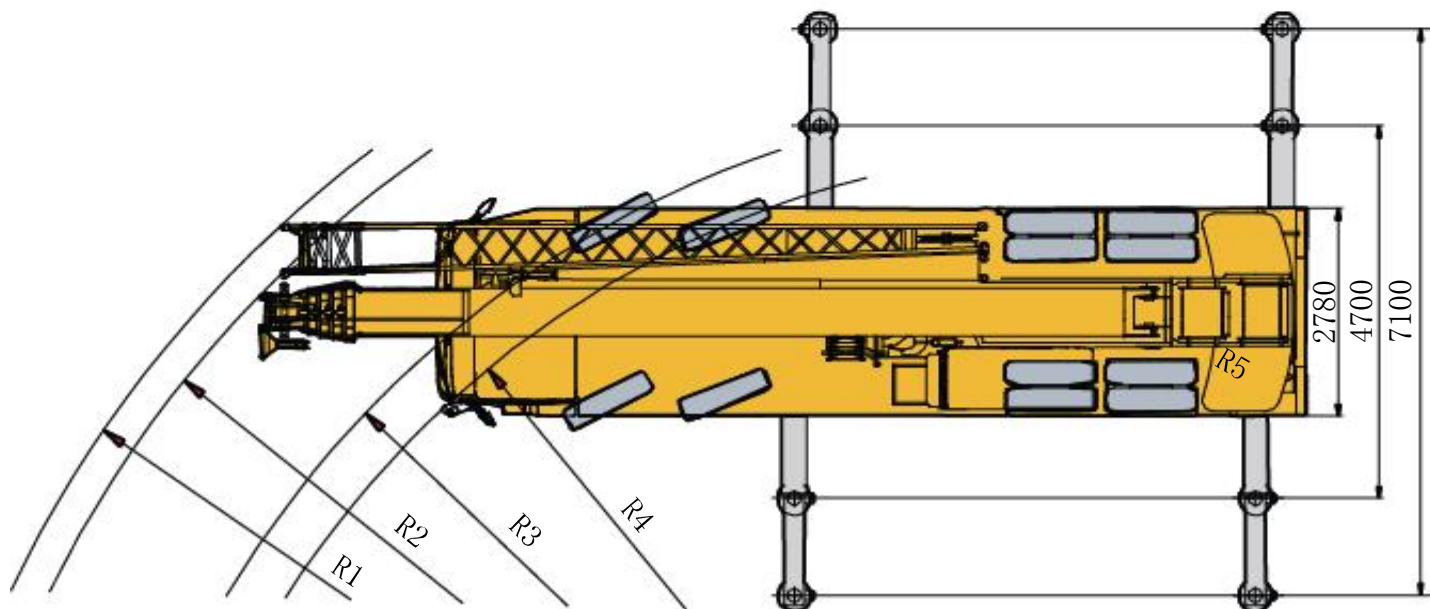
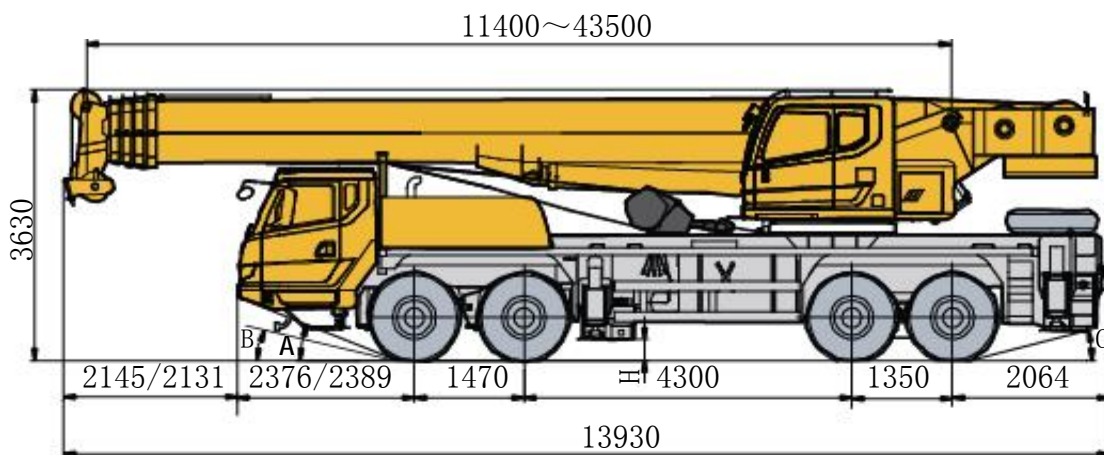

	A	B	C	H	R1	R2	R3	R4	R5
12.00R24-18PR	19°	12°	15°	280	14600	14500	12000	11500	3800

## 技术规格

### Technical specifications



#### 底盘

<b>车架</b>	徐工设计、制造，受力结构优化设计，防扭转箱型结构，进口高强度钢材制造。支腿箱体位于2桥和3桥之间以及车架后端，具有前后牵引挂钩。
<b>支腿</b>	4支腿。纵向H形布置，操作杆控制液压动作。可由底任一侧同时或单独控制各支腿的动作，设有水平仪。 支腿油缸均设有单向阀，且垂直支腿带有双向液压锁。 支脚盘尺寸：φ450mm 最大起重量时支腿反力：490KN
<b>发动机</b>	中国重型汽车集团，直列、六缸、水冷、增压中冷、电控 D10.38-50，额定功率276kW/2000rpm，最大扭矩1560Nm/1200-1500rpm，国V排放标准。
<b>变速箱</b>	9档变速箱，远距离软轴机械操纵，带同步器。
<b>车桥</b>	高强度桥，引进国外先进技术，名牌厂家制造，性能可靠。
<b>悬挂</b>	后悬挂系统，采用V型推力杆结构、橡胶弹簧悬架，增加底盘行驶稳定性，减少轮胎的磨损。
<b>轮胎</b>	12.00R24，×12 备胎12.00R24，×1 轮辋：8.5-24
<b>制动</b>	行车制动：脚踏板操纵的双回路气压制动。第一回路作用于一、二轴车轮上，第二回路作用于三、四轴车轮上。 驻车制动：弹簧贮能制动，作用于三、四轴车轮； 辅助制动：发动机缸内制动、排气制动，安全可靠，延长制动摩擦片使用寿命。
<b>转向</b>	机械式转向机构，带有液压助力。
<b>驾驶室</b>	全宽豪华驾驶室，标配收音机，可调式座椅、方向盘，大视野后视镜，手动门窗升降器，标配暖风、空调。
<b>电气系统</b>	直流24伏特，串联12伏特的电池组2个。 发电机：28.5±0.3伏特，70安培。



#### 上车

<b>结构</b>	徐工设计、制造，高强度钢材制造。
<b>液压系统</b>	液压泵：底盘发动机驱动四联泵，变量泵用于起升、变幅、伸缩。 控制阀：先导液压油控制的负荷敏感式比例多路换向阀，带有抗冲击阀、防气蚀阀。 油路：风冷式液压油冷却器，有效降低系统油温 滤油器：进、回油滤油器
<b>操纵方式</b>	无级调速。先导液比例操纵，由左右2个操纵手柄控制 由液压泵和比例阀进行液压先导式控制起重机的全部动作。
<b>主起升机构</b>	压控制调速，装有双折线绳槽卷筒，由液压马达通过行星齿轮减速器驱动，内置常闭式制动器并带有平衡阀。 具有轻载高速、重载低速的特点。
<b>回转机构</b>	单排四点接触球外齿式回转支承，由液压马达驱动行星齿轮 轮回转机构减速器驱动，可连续回转360°。 设有脚踏板操作的回转制动器。 具有动力控制或自由滑转的功能，可无级调速。
<b>变幅机构</b>	单支双作用前置液压变幅油缸，带有平衡阀。
<b>操纵室</b>	新型钢制操纵室，装有无视野死角的前景窗，安全玻璃，车窗装有遮阳板，推拉式车门，座椅靠背可倾斜定位，操纵杆安装在座椅两侧的扶手台上。 带推拉踏板，方便人员进出。 前窗顶窗装有雨刮器，标准的操纵控制件和指示器。 配备冷暖空调。
<b>安全装置</b>	液压平衡阀；液压溢流阀；液压双向锁；力矩限制器；操纵杆弹簧式回中系统；三圈保护器，防止钢丝绳过放；臂头设置高度限位，防止钢丝绳过卷

## 技术规格

### Technical specifications



#### 臂架系统

<b>主臂</b>	由1节基本臂和4节伸缩臂组成，采用抗扭曲设计，高强度结构钢制造。主臂长度：11.4m ~ 43.5m。
<b>臂端单滑轮</b>	单滑轮，安装在主臂顶端用于单股钢丝绳起重作业，起重性能与主臂相同，但最大起重量不超过4.5t。
<b>固定副臂</b>	两节副臂，一节桁架式副臂，工作长度9.5m，二节箱型副臂，两节臂全伸工作长度16m，安装角度0°、15°、30°。

#### 选装配置

<b>底盘发动机</b>	中国重型汽车集团，直列、六缸、水冷、增压中冷、电控；WD615.338，额定功率276kW/2200rpm，最大扭矩1500Nm/1100-1600rpm，国III排放标准。
<b>底盘发动机</b>	中国重型汽车集团，直列、六缸、水冷、增压中冷、电控；D10.38A-40，额定功率276kW/2200rpm，最大扭矩1500Nm/1100-1600rpm，国IV排放标准。

产品各部件明细如上所述，具体部件明细请参照产品报价单

## 技术规格

### Technical specifications



#### Chassis

<b>Frame</b>	Designed and manufactured by XCMG, with all covered walking surface, anti-torsion box structure and optimal load-bearing structure design, made of imported high strength steel.
<b>Outrigger</b>	Four outriggers are arranged in H shape longitudinally, with outrigger beams and jacks hydraulically controlled by control levers. Control levers are located on both sides of the chassis, with a luminous level gauge equipped. Check valve is fitted in each outrigger cylinder, and double-way valve is fitted in jack cylinder. Outrigger float dimension : $\phi 450\text{mm}$ Max. outrigger reaction force : 490KN
<b>Engine</b>	D10.38-50, in-line six-cylinder water-cooled EFI diesel engine, manufactured by CHINA NATIONAL HEAVY DUTY TRUCK GROUP CO., LTD., rated power 276kW /2000rpm, max. torque 1560Nm / 1200-1500rpm, the national V emission standards. Fuel tank capacity : 320L
<b>Gearbox</b>	9-speed transmission, manually mechanical control by long distance soft axle, synchronizer is equipped.
<b>Alxes</b>	High strength axle with reliable performance, adopted oversea advanced technology and produced by famous company.
<b>Suspension</b>	Rear suspension, V-type thrust rod structure, and rubberspring suspension, to increase chassis driving stability and reduce tire wear.
<b>Tires</b>	12.00R24 , $\times 12$ Reserve:12.00R24 , $\times 1$ Rim: 8.5-24
<b>Brakes</b>	Service brake.....foot pedal control, double-circuit air brake. The 1st circuit acts on the wheels of 1st axle, the 2nd circuit acts on the wheels of 3rd and 4th axles. Parking brake.....air-releasing brake, which acts on 3rd and 4th axles. Auxiliary brake.....engine cylinder inner-brake and engine exhaust brake, safety and reliability and extend the service life of brake friction disc.
<b>Steering</b>	Mechanical steering system with hydraulic boosting device.
<b>Driver's cab</b>	Full-dimension luxurious driver's cab. Radio, adjustable seat, steering wheel, large-view rear mirrors and manually operated lifters for door windows are equipped. Heater, air-conditioner are standard.
<b>Electric power system</b>	DC 24 V, two 12 V battery group in series. 28.5 $\pm$ 0.3V70 ampere generator.



#### Superstructure

<b>Frame</b>	Designed and manufactured by XCMG; Full-covered walking platform, made of high-strength steel
<b>Hydraulic system</b>	Hydraulic pump:quadruple pump is driven by chassis engine , variable-displacement pump used for hoisting, elevating and telescoping system. Control valve:load sensitive proportional multi-way change valve controlled by pilot hydraulic oil, impact-resistant valve and anti-cavitation corrosion valve are equipped. Oil circuit:air-cooled hydraulic oil cooler, which may effectively reduce the temperature of oil in the system Oil filters:suction filter and return filter
<b>Operating mode</b>	Stepless speed regulation is available. All the movements of the crane is controlled by hydraulic pump, proportional valve and pilot hydraulic-proportional control system, controlled by two control levers at left and right.
<b>Main winch system</b>	Hydraulic controlled speed regulation, groove drum is equipped, driven by hydraulic motor through planetary gear reducer, and built-in normally closed brake and counterbalance valve are available. Hoisting system has features of high speed with light load and low speed with heavy load.
<b>Slewing system</b>	Single-row 4-point contact ball external tooth slewing ring. Slewing system is driven by hydraulic motor, with planetary gear reducer, for 360° continuous rotation, stepless slewing speed regulation is available. Functions such as power control or free sliding are equipped, and foot pedal is fitted to control slewing brake.
<b>Elevating system</b>	Single-supported double acting front-mounted hydraulic elevating cylinder, with balance valve equipped.
<b>Operator's cab</b>	The new steel cab is located at the left side of turntable, equipped with no dead vision front glass, safe glass, sun visor, sliding door, adjustable seat, two operating levers beside the seat, indicators, electric window wiper, pull-push pedal facilitate personnel access. Heater and air conditioner are available.
<b>Safety devices</b>	Hydraulic balance valve; Hydraulic over-flow valve; Hydraulic double-way valve; Load Moment Indicator(LMI); Lever spring-back middle position system; Lowering limiter avoids wire rope over-releasing; Anti-two block at boom head avoids wire rope over-winding;



## 技术规格

### Technical specifications



#### Boom system

<b>Boom</b>	1-section base boom and 4-section telescopic boom, with anti-twist design and high-strength steel structure. Main boom length.....11.4m ~ 43.5m
<b>Single top</b>	Single top is installed on the top of main boom, for single wire rope hoist. Its lifting performance is the same as main boom , but its max. lifting load not exceeding 4500kg.
<b>Jib</b>	2-section , 1st section jib is lattice welding structure and length 9.5m, 2nd section jib is box welding structure. The max. length of jib is 16m, 0°, 15° and 30° offset angles are available.

#### Additional equipment

<b>Engine</b>	WD615.338, in-line six-cylinder water-cooled EFI diesel engine, manufactured by CHINA NATIONAL HEAVY DUTY TRUCK GROUP CO., LTD., rated power 276kW /2200rpm, max. torque 1500Nm / 1100-1600rpm, the national III emission standards. Fuel tank capacity : 320L
<b>Engine</b>	D10.38A-50, in-line six-cylinder water-cooled EFI diesel engine, manufactured by CHINA NATIONAL HEAVY DUTY TRUCK GROUP CO., LTD., rated power 276kW /2200rpm, max. torque 1500Nm / 1100-1600rpm, the national IV emission standards. Fuel tank capacity : 320L

**Product parts details As mentioned above, please refer to the product quotation for specific parts.**

## 重量 Weight





车桥 Axle	1	2	3	4	总重量 Total weight
t	8.1	8.1	13	13	42.2







吊钩 Hook	倍率 No. of lines	吊钩重量 Weight kg	备注 Remarks
55t	12	515	单钩 Single hook , 标配 Standard
35t	10	403	单钩 Single hook , 选配 Optional
4.5t	1	100	单钩 Single hook , 标配 Standard

## 作业速度 Working speeds



		
12.00 R 24	1 ~ 85	42%



作业机构 Drive	作业速度 Working speed	最大单绳拉力 Max. single line pull	钢丝绳直径/长度 Rope diameter/ length
	0-130 m/min, 单绳, 第四层 m/min, single line, 4th layer	48 kN	18 mm/190 m
	0-130 m/min, 单绳, 第四层 m/min, single line, 4th layer	48 kN	18 mm/125 m
	0-2r/min		
	从-2°抬起至80°约40s Approx. 40s for boom elevation from -2° to 80°		
	从11.4m伸出至43.5m约90s Approx. 90s for boom extension from 11.4m to 43.5m		



## 臂架组合方案

Boom / Jib combinations



主臂  
Telescopic boom

T : 11.4~43.5m

副臂  
Jib

T : 43.5m  
J : 9.5~16 m

# 起升高度曲线图 Lifting heights

主臂  
Boom

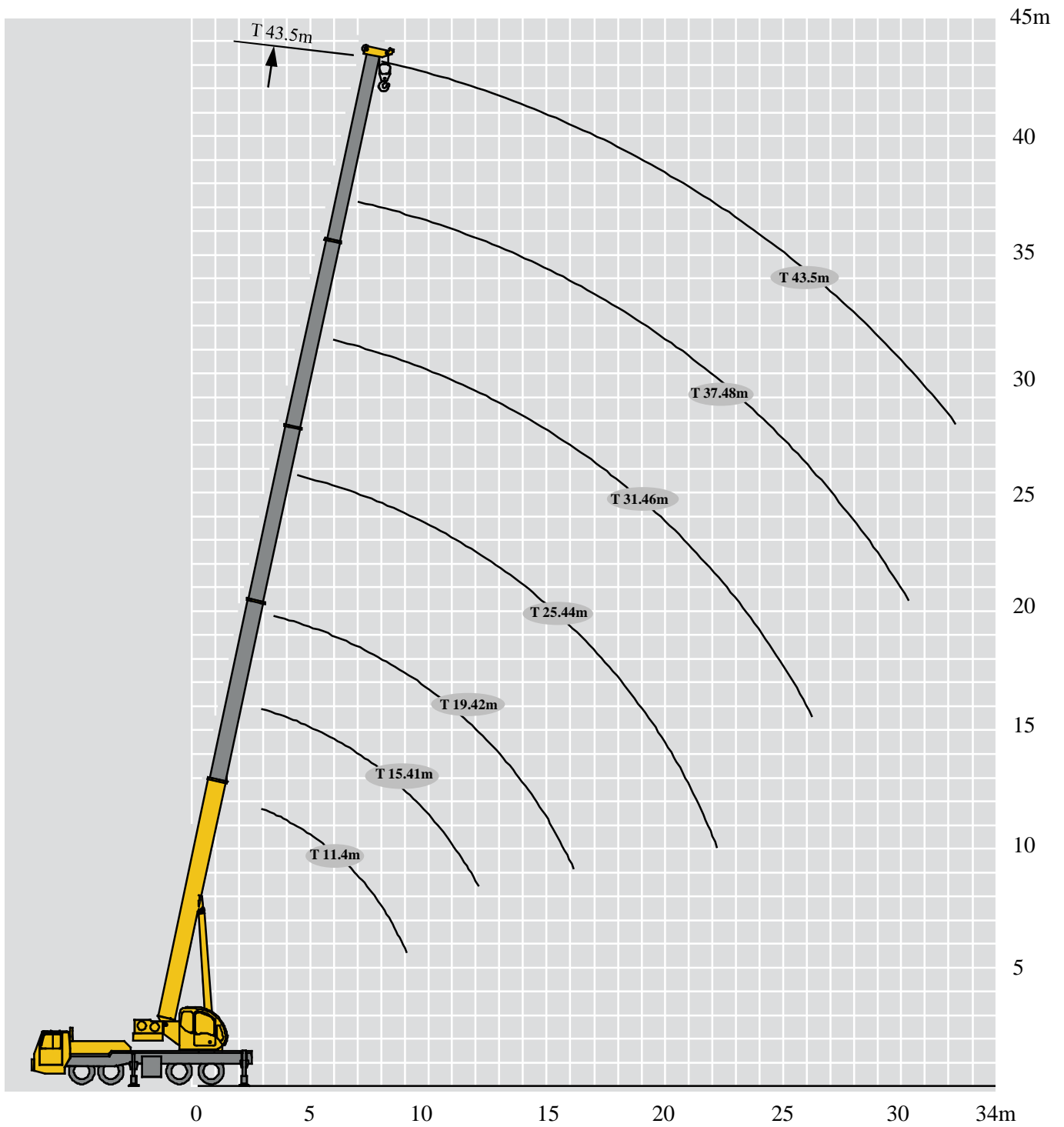

# 起重性能表

## Lifting capacities

T 11.4~43.5m

	   								
	11.4m	15.41m	19.42m	25.44m	31.46m	37.48m	43.5m		
3	55000	45000						3	
3.5	50100	45000						3.5	
4	48100	45000	35000	25000				4	
4.5	45100	43000	33000	25000				4.5	
5	41000	40000	32000	25000	18500			5	
5.5	36600	36000	29000	25000	18500				
6	33100	32500	27000	23300	18500			6	
7	27100	26600	24500	21000	18500	14000		7	
8	22300	22600	22500	19000	17700	13200	9500	8	
9	17600	18000	17600	17000	16300	12500	9500	9	
10		14600	14200	15400	15000	11800	9300	10	
12		10100	10000	10700	11300	10300	8600	12	
14			7200	7900	8400	8800	7900	14	
16			5300	6000	6500	6800	7100	16	
18				4600	5100	5400	5600	18	
20				3500	4000	4300	4500	20	
22				2700	3100	3600	3700	22	
24					2500	2800	3000	24	
26					1800	2200	2400	26	
28						1700	1950	28	
30						1300	1500	30	
32							1200	32	

# 起重性能表

## Lifting capacities



T 11.4~43.5m

	   							
	11.4m	15.41m	19.42m	25.44m	31.46m	37.48m	43.5m	
3	55000	45000						3
3.5	50100	45000						3.5
4	48100	45000	35000	25000				4
4.5	45100	43000	33000	25000				4.5
5	40100	40000	32000	25000	18500			5
5.5	36100	35700	29000	25000	18500			
6	32600	31800	27000	23300	18500			6
7	26900	26500	24500	21000	18500	14000		7
8	21100	21600	22000	19000	17700	13200	9500	8
9	16600	17200	17100	17000	16300	12500	9500	9
10		13800	13700	14600	15000	11800	9300	10
12		9500	9400	10100	10700	10300	8600	12
14			6700	7400	7900	8300	7900	14
16			4900	5500	6100	6400	6600	16
18				4200	4700	5000	5300	18
20				3200	3700	4000	4200	20
22				2400	2900	3200	3400	22
24					2200	2500	2700	24
26					1700	2000	2200	26
28						1500	1700	28
30						1100	1400	30
32							1000	32

# 起重性能表

## Lifting capacities

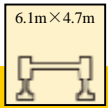

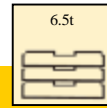



T 11.4~43.5m

	   							
	11.4m	15.41m	19.42m	25.44m	31.46m	37.48m	43.5m	
3	55000	45000						3
3.5	50100	45000						3.5
4	48100	45000	35000	25000				4
4.5	36500	36400	33000	25000				4.5
5	28700	28600	28700	25000	18500			5
5.5	23400	23300	23300	24800	18500			
6	19600	19500	19500	20800	18500			6
7	14400	14200	14200	15400	16200	14000		7
8	11000	10900	10900	12000	12700	12900	9500	8
9	8600	8500	8500	9500	10200	10400	9500	9
10		6800	6700	7800	8400	8600	8900	10
12		4300	4300	5300	5900	6100	6400	12
14			2700	3700	4200	4500	4700	14
16			1600	2500	3100	3300	3500	16
18				1600	2200	2500	2700	18
20				1000	1500	1800	2000	20
22					1000	1300	1500	22
24					500	800	1000	24
26						500	700	26

# 起重性能表

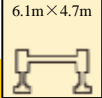
## Lifting capacities

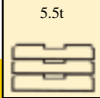
T 11.4~43.5m

	   							
	11.4m	15.41m	19.42m	25.44m	31.46m	37.48m	43.5m	
3	55000	45000						3
3.5	50100	45000						3.5
4	46300	45000	35000	25000				4
4.5	34500	34500	33000	25000				4.5
5	27100	27100	27100	25000	18500			5
5.5	22000	22000	22000	23500	18500			
6	18400	18300	18400	19700	18500			6
7	13400	13400	13400	14600	15300	14000		7
8	10200	10100	10100	11200	12000	12200	9500	8
9	7900	7900	7900	8900	9600	9800	9500	9
10		6200	6200	7200	7900	8100	8300	10
12		3900	3900	4900	5500	5700	5900	12
14			2400	3200	3900	4100	4400	14
16			1300	2100	2800	3000	3200	16
18				1400	1900	2200	2400	18
20				800	1300	1600	1800	20
22					800	1100	1300	22
24						600	800	24
26							500	26

起升高度曲线图  
Lifting heights

副臂  
Jib

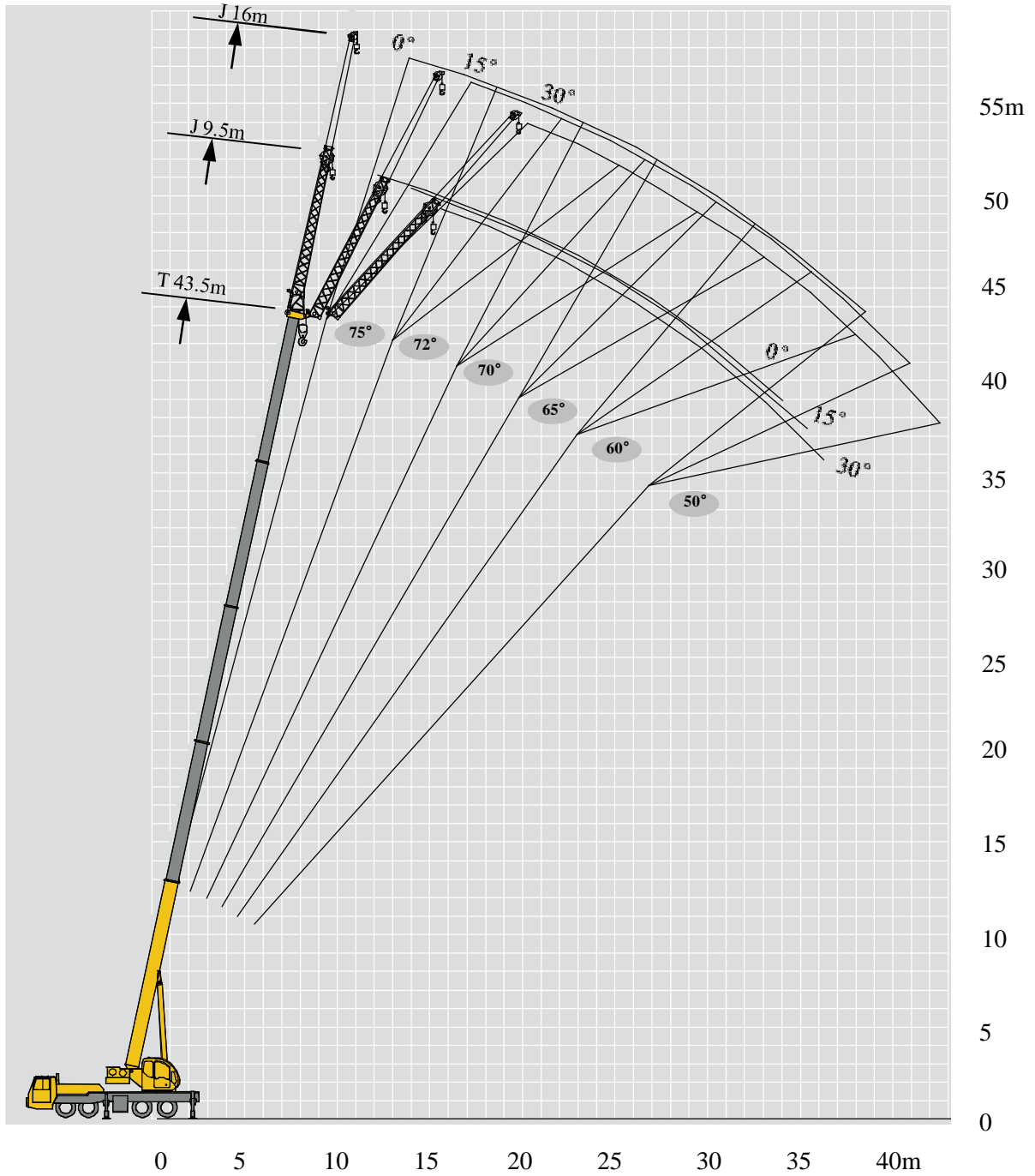









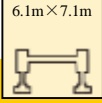

# 起重性能表

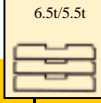
## Lifting capacities

T 43.5m

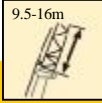
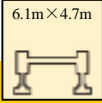
	    						
	9.5 m			16 m			
	0°	15°	30°	0°	15°	30°	
<b>78</b>	4500	3000	2500	2800	1500	1200	<b>78</b>
<b>75</b>	4000	2700	2400	2200	1300	1100	<b>75</b>
<b>72</b>	3500	2500	2300	1900	1200	1000	<b>72</b>
<b>70</b>	3200	2300	2200	1800	1200	950	<b>70</b>
<b>65</b>	2550	2100	1900	1600	1000	850	<b>65</b>
<b>60</b>	2000	1700	1600	1200	900	750	<b>60</b>
<b>55</b>	1200	1000	900	850	700	650	<b>55</b>
<b>50</b>	600	500	500	450	400	350	<b>50</b>

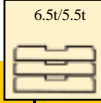

















	    						
	9.5 m			16 m			
	0°	15°	30°	0°	15°	30°	
<b>78</b>	4500	3000	2500	2800	1500	1200	<b>78</b>
<b>75</b>	3800	2700	2400	2200	1300	1100	<b>75</b>
<b>72</b>	2700	2400	2200	1800	1200	950	<b>72</b>
<b>70</b>	2100	1900	1700	1600	1100	900	<b>70</b>
<b>65</b>	1150	1000	1000	800	600	600	<b>65</b>
<b>60</b>	500	500	400				<b>60</b>

# 符号标识

## Description of symbols

### 常规标识

#### General symbols

	上车 Superstructure		底盘 Chassis
	起重能力 lifting capacity		车桥 Axle
	吊臂长度 Boom length		行驶速度 Driving speed
	工作幅度 Radius		爬坡能力 Gradability
	吊臂仰角 Boom position		轮胎 Tyres
	主臂起升高度 Hoist height with Boom		支腿 Outriggers
	固定副臂长度 Fixed jib length		吊钩 Hook block
	副臂起升高度 Hoist height with jib		平衡重 Counterweight
	360°全回转 360° rotation		卷扬 Winch

## 主要技术参数表 Transportation plan

类别 Category	项目 Item	单位 Unit	参数 Parameter		
尺寸参数 Dimensions	外形尺寸 (长×宽×高) Outline size (length×width×height)	mm	13930×2780×3630		
	轴距 Wheel base	mm	1470/4300/1350		
	轮距 (前/后) Track (Front/Rear)	mm	2304/2075		
	前悬/后悬 Front/Rear overhang	mm	2389/2064或2376/2064		
	前伸/后伸 Front/Rear extension	mm	2131/226或2145/226		
重量参数 Weight	最大允许总质量	kg	42200		
	轴荷	一轴、二轴 1st and 2nd axle	kg	16200	
		三轴、四轴 3rd and 4th axle	kg	26000	
动力参数 Power	发动机型号 Engine model	—	WD615.338 国III	D10.38A-40 国IV	D10.38-50 国V
	额定功率/转速 Engine rated power/rpm	kW/(r/min)	276/2200		276/2000
	最大净功率/转速 Max. net power/rpm	kW/(r/min)	274/2200		274/2000
	最大输出扭矩/转速 Engine rated torque/rpm	N.m/(r/min)	1500/1100-1600		1560/1200-1500
行驶参数 Travel	最高车速 Max. travel speed	km/h	85		80
	最低稳定车速 Min. travel speed	km/h	2~3		
	最小转弯直径 Min. turning diameter	m	24		
	臂头最小转弯直径 Min. turning diameter at boom tip	m	29.2		
	最小离地间隙 Min. ground clearance	mm	327		
	接近角 Approach angle	°	19/12 (带前防护)		
	离去角 Departure angle	°	15		
	制动距离 (制动初速度为30km/h) Braking distance (at 30 km/h)	m	≤10		
	最大爬坡能力 Max. grade ability	%	42		
	百公里油耗 Fuel consumption per 100 km	L	40		
噪音 Noise	加速行驶机外噪声 Exterior noise level	dB(A)	≤88		
	驾驶员耳旁噪声 Noise level at seated position	dB(A)	≤90		

## 主要技术参数表 Transportation plan

类别 Category	项目 Item		单位 Unit	参数 Parameter	
主要性能参数 Main performance	最大额定总起重量 Max. total rated lifting capacity		t	55	
	最小额定工作幅度 Min. rated working radius		m	3	
	转台尾部回转半径 Turning radius at turntable tail		mm	3800	
	最大起重力矩 Max. load moment	基本臂 Base boom	kN.m	2009	
		最长主臂 Fully-extended boom	kN.m	1129	
		最长主臂+副臂 Fully-extended boom + Jib	kN.m	620	
	支腿跨距 Outrigger span	纵向 Longitudinal	m	6.1	
		横向 Lateral	m	7.1	
	起升高度 Hoist height	基本臂 Base boom	m	11.9	
		最长主臂 Fully-extended boom	m	44	
		最长主臂+副臂 Fully-extended boom + Jib	m	58.1	
	起重臂长度 Boom length	基本臂 Base boom	m	11.4	
		最长主臂 Fully-extended boom	m	43.5	
最长主臂+副臂 Fully-extended boom + Jib		m	59.5		
副臂安装角 Jib offset angle		°	0、15、30		
工作速度参数 Working speed	起重臂起臂时间 Boom raising time		s	≤40	
	起重臂全伸时间 Boom fully extended time		s	≤90	
	最大回转速度 Max. slewing speed		r/min	≥2.0	
	支腿收放时间 Outrigger extending and retracting time	水平支腿 Outrigger beam	收 Retracting	s	≤30
			放 Extending	s	≤35
		垂直支腿 Outrigger jack	收 Retracting	s	≤35
			放 Extending	s	≤40
起升速度 (单绳,第四层,空载) Hoisting speed (single line, 4th layer, no load)	主起升机构 Main winch	m/min	≥130		
	副起升机构 Auxiliary winch	m/min	≥130		
噪声 Noise	机外辐射 Exterior noise level		dB ( A )	≤124	
	司机位置处 Noise level at seated position		dB ( A )	≤90	

## 注意事项

### Notes

1. 表中额定总起重量值，是在平整的坚固地面上本起重机能够保证的最大总起重量，包括吊钩和吊具的重量，所以为了估算重物重量，必须减去上述的装置重量。
2. 表中的工作幅度为起吊重物离地时起重物到起重机回转轴线的水平距离，是包括起重臂变形量在内的实际值，因而起吊前应考虑起重臂变形量。
3. 只允许在5级(瞬时风速14.1m/s，风压125N/m<sup>2</sup>)风以下进行作业。
4. 吊重前操作者必须对物体的重量和工作范围了解后选择合适的作业工况，严禁超出表中的数值。幅度及臂长在相邻两个数值之间时，应依据两个数值中较小值确定起重作业。
5. 应按主臂仰角范围作业，即使是空载，也不应使主臂仰角处于范围外，谨防整机倾翻。
6. 表中的主臂长度应要按照每节臂的伸缩要求进行伸出。

1. The total rated loads given in the rated load charts are the maximum lifting capacity when the crane is set up on firm and level ground, which includes the weight of the hook block and slings. The weight of above-mentioned devices should be deducted to correctly calculate the load weight.
2. The working radius shown in the rated load charts is the radius when the load is lifted off the ground, and it is the actual value including loaded boom deflection.
3. A lifting operation is permissible only when the wind force is below grade 5 (instantaneous wind speed is 14.1 m/s, wind pressure is 125 N/m<sup>2</sup>).
4. Before beginning lifting operation, the operator should know the weight of the load to be lifted and its working range, and then select proper working conditions. Never operate the crane beyond the limit shown in the chart. Use the lower value from the chart when the boom length or working radius is between the range of values.
5. Observe the boom angle limit. Never operate the crane with the boom angle beyond the recommended limit even if a load is not being carried. Otherwise, the crane will tip.
6. The boom length given in the rated load charts should accord with the telescoping code of boom sections .



地址：江苏省徐州市经济技术开发区高新路68号

Add : No. 68, Gaoxin Road, Economic Development  
Zone, Xuzhou, Jiangsu Province, China

电话(Tel) : +86-516-83462242/83462350

质量监督电话(Quality Inquiry Tel) : +86-516-87888268

备件电话(Spare Parts Tel) : +86-516-83461542

邮编(Post Code) : 221004

网址(Web) : [www.xcmg.com/qizhongji](http://www.xcmg.com/qizhongji)

服务热线 Service Tel

400-110-9999

400-001-5678



本印刷品不属于合同。出于产品不断改进的需要，我们保留对产品型号、参数、配置进行变更的权利，恕不另行通知。图片仅供参考，具体产品以实物为准。图片中产品可能并非标准配置，部分部件可能需要另行购置。办理牌照和上路行驶需遵守当地法规。

This print does not belong to the contract. We reserve the right to modify the design (such as product model, parameters and configuration) without notice for improvement. The pictures are just for reference. The product in the picture may not be standard configuration. Some parts need to be purchased separately. Conform to the local laws for license application and road traveling.