

# 汽车起重机 / Truck Crane

**QY25KC**

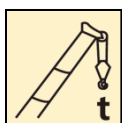

25 t

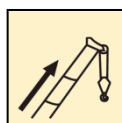

35 m

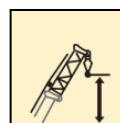

43.4 m



2020年6月 第1版

# 目录

## Content

|   |       |
|---|-------|
| <b>目录</b><br><b>Content</b>                   |       |
| 尺寸参数<br>Dimensions                            | 4     |
| 技术规格<br>Product Specifications                | 5-8   |
| 重量/作业速度<br>Weight / Working speeds            | 9     |
| 臂架组合方案<br>Boom / Jib combinations             | 10    |
| 主臂<br>Boom                                    | 11-12 |
| 副臂<br>Jib                                     | 13-14 |
| 注意事项<br>Notes                                 | 15    |
| 符号标识<br>Description of symbols                | 16    |
| 主要技术参数表<br>Table of main technical parameters | 17-18 |

# 尺寸参数

## Dimensions

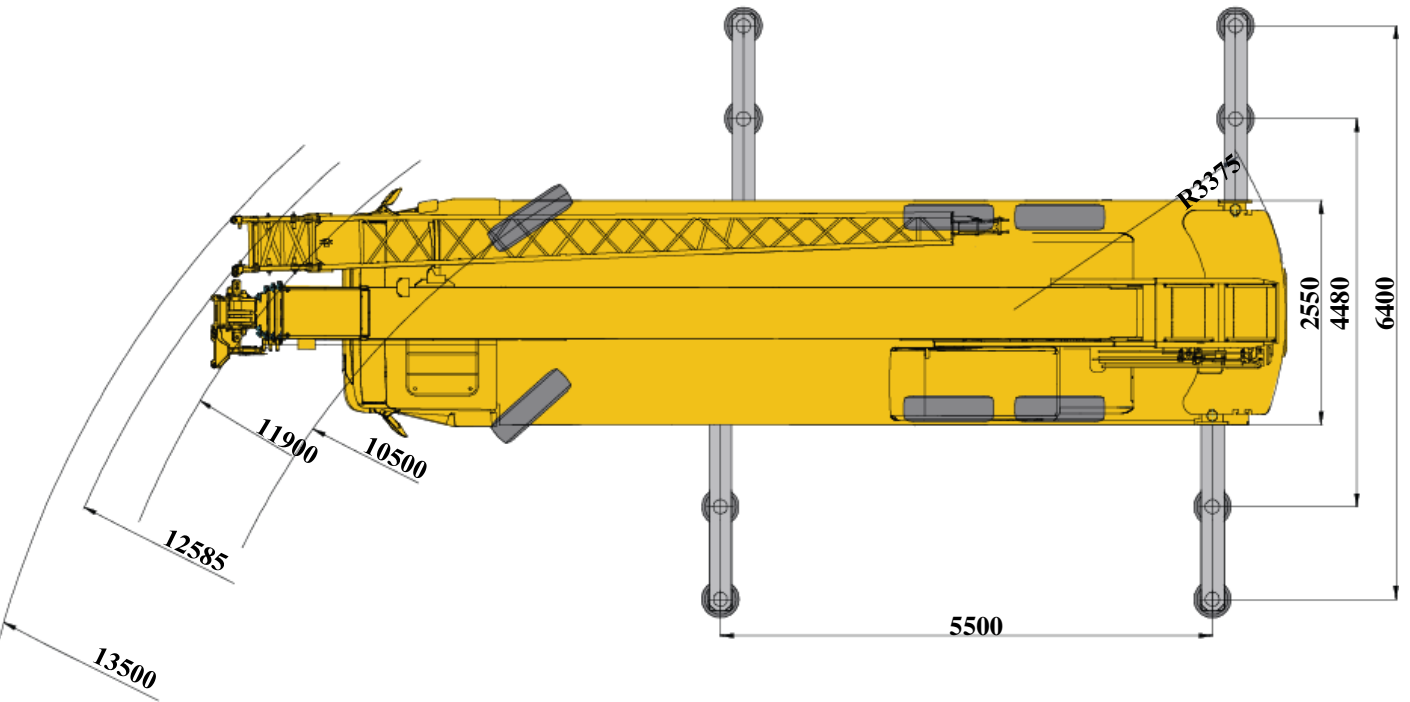
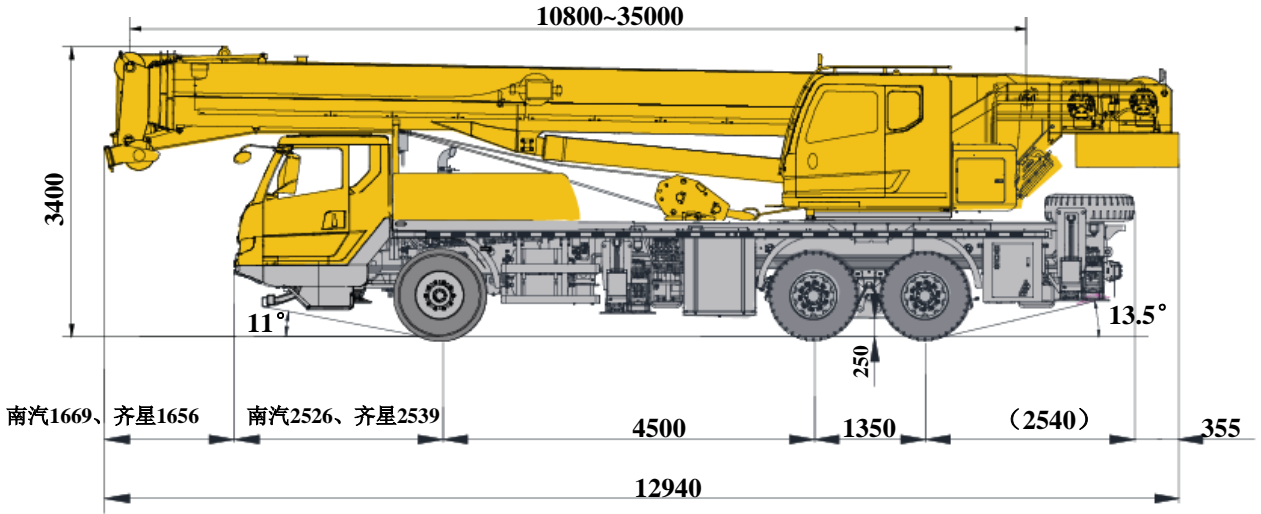

# 技术规格

## Technical specifications

|  底盘 | 配置  |
|---|---|
| <b>车架</b>   | 徐工设计、制造，全覆盖式走台板，防扭转箱型结构，高强度钢材制造。 ●  |
| <b>支腿</b>   | 4支腿；纵向H形布置，操作杆控制液压动作；可由底盘任一侧同时或单独控制各支腿的动作，设有水平仪；带第五支腿；且垂直支腿带有液压双向锁。<br>支脚盘尺寸：φ400mm<br>最大起重量时支腿反力：323KN ● |
| <b>发动机</b>  | SC9DF300.1Q5，直列六缸水冷电控柴油发动机，上柴，额定功率221kW/2200rpm，最大扭矩1250Nm/1400rpm，国V排放标准。燃油箱容积：320L。 ●                   |
| <b>变速箱</b>  | 法士特9档变速箱，机械操纵，带同步器。 ●   |
| <b>车桥</b>   | 配置美驰、汉德高强度车桥，2,3桥驱动。 ●  |
| <b>悬挂</b>   | 前悬架：纵置钢板弹簧，筒式减震器；后悬架：橡胶悬架，重量轻，免维护。 ●  |
| <b>轮胎</b>   | 10个轮胎，1个备胎，前 11.00-20<br>桥装单胎，中桥、后桥 315/80R22.5<br>装双胎。 ● ○   |
| <b>制动</b>   | 行车制动：双回路气压制动，作用于所有车轮。<br>驻车制动：弹簧贮能制动，作用于2-3轴车轮。<br>辅助制动：发动机排气制动和缓速制动 ●                                    |
| <b>转向</b>   | 机械式转向机构，带有液压助力 ●  |
| <b>驾驶室</b>  | 全宽驾驶室，乘员3人；配置收放机、可调式座椅、简易卧铺、方向盘、安全玻璃、3只雨刷器、电动后视镜、电动门窗升降器、杂物箱、空调 ●   |
| <b>电气系统</b>   | 直流24伏特，串联12伏特的电池组2个；<br>发电机 28伏特-70安培；<br>GPS车载定位通讯终端； ●  |
| <b>电气系统</b>   | 倒车影像 ○  |

|  上车 | 配置   |
|--|--|
| <b>结构</b>  | 徐工设计、制造，高强度钢材制造。 ●   |
| <b>液压系统</b>  | 专用节流装置匹配阀后补偿负载敏感设计，系统最低流量更稳定，系统刚度更合理，作业微动性、平顺性更突出；采用分合流技术，起升、变幅、伸缩双泵合流，主、副卷作业速度高达135m/min，作业效率全面领先，复合动作时双泵独立供油各执行元件流量分配更优化，作业效率突出。 ● |
| <b>操纵方式</b>  | 先导操纵 ●<br>机械操纵 ○   |
| <b>主起升机构</b>   | 液压控制调速，装有双折线绳槽卷筒，由液压马达通过行星齿轮减速器驱动，内置常闭式制动器并带有平衡阀； ●  |
| <b>副起升机构</b>   | 液压控制调速，装有双折线绳槽卷筒，由液压马达通过行星齿轮减速器驱动，内置常闭式制动器并带有平衡阀； ●  |
| <b>回转机构</b>  | 四点接触球式回转支承，由液压马达驱动行星齿轮回转机构减速器驱动，可连续回转360°；具有动力控制或自由回转的功能，可无级调速；回转杆设有鸣响开关； ●  |
| <b>变幅机构</b>  | 单支双作用前置液压变幅油缸，带有平衡阀 ●  |
| <b>操纵室</b>   | 按人机工程学设计，推拉式车门（先导），可调式座椅。<br>装有安全玻璃和顶部保护栏。前窗装有遮阳帘。标配风扇，冷暖空调。 ●   |
| <b>操纵室</b>   | 按人机工程学设计，外开式车门（机械），可调式座椅。<br>装有安全玻璃和顶部保护栏。前窗装有遮阳帘。标配风扇，冷暖空调。 ○   |
| <b>安全装置</b>  | 液压平衡阀；液压溢流阀；液压双向锁；力矩限制器；三圈保护器，防止钢丝绳过放；臂头设置高度限位，防止钢丝绳过卷；三色报警灯； ●  |
| <b>平衡重</b>   | 5t ●   |

## 技术规格

### Technical specifications

|  臂架系统 | 配置 |
|---|----|
| <b>主臂</b> 4节，“U”形截面的筒形焊接结构。<br>单缸绳排伸缩机构<br>主臂长度：10.8m~35m。                            | ●  |
| <b>臂端单滑</b> 单滑轮, 安装在主臂顶端用于单股钢<br><b>轮</b> 丝绳起重作业, 起重性能与主臂相同<br>但最大起重量不超过3t。           | ●  |
| <b>固定副臂</b> 1节桁架式焊接结构, 具有0°、15°、<br>30°三种固定副臂安装角<br>固定副臂长度：9m                         | ●  |

产品各部件明细如上所述，具体部件明细请  
参照产品报价单

符号说明：

- —— 表示标准配置；
- —— 表示选装配置。

# 技术规格

## Technical specifications

|  Chassis | Configuration   |
|--|---|
| <b>Frame</b>   | Designed and manufactured by XCMG, with all covered walking surface, anti-torsion box structure and optimal load-bearing structure design, made of imported high strength steel. ●  |
| <b>Outrigger</b>   | 4 outriggers, H-shaped arrangement, lateral and vertical outrigger controlled by the hydraulic control. Control levers are located on both sides of the chassis, with a luminous level gauge equipped, with the fifth jack, and the vertical outrigger has two-way hydraulic lock. Outrigger float dimension: φ400mm Max. outrigger reaction force: 323KN ● |
| <b>Engine</b>  | SC9DF300.1Q5 , in-line six-cylinder water-cooled EFI diesel engine, manufactured by Shanghai Diesel Engine Co., Ltd., rated power 221kW /2200rpm, max. torque 1250Nm / 1400rpm, the national V emission standards. Fuel tank capacity : 320L ●  |
| <b>Gearbox</b>   | FAST manually mechanical control , 9-speed available, synchronizer is equipped. ●   |
| <b>Axles</b>   | High strength axle with reliable performance from Meritor. 2nd axle and 3rd axle for driving ●  |
| <b>Suspension</b>  | Front suspension: longitudinal leaf spring suspension with barrel shock absorber; Rear suspension: V-type thrust rod structure, and rubber spring suspension. ●   |
| <b>Tires</b>   | 10 tires and 1 spare tire, front axle is equipped with 11.00-20 single tire, middle axle and rear axle are equipped with double tire. ●<br>315/80R22.5 ○  |
| <b>Brakes</b>  | Service brake: double-circuit air pressure brake, acting on all wheels. ●<br>Parking brake: spring energy brake, acting on wheels of 2-3 axles.<br>Auxiliary brake: engine exhaust brake and engine in-cylinder brake.  |
| <b>Steering</b>  | Mechanically steering mechanism with hydraulic power assisted. ●  |
| <b>Driver's cab</b>  | Full-dimension driver's cab, three passengers are allowable. Equipped with radio, adjustable seats, simple sleeper , steering wheel, safety glasses, electrically controlled windshield washer, electrically operated rearview mirror , electrically operated door window and glove box. Heater and air conditioner are available. ●                        |
| <b>Electrical system</b>   | 24V DC, two sets of battery. ●<br>Generator: 28.5±0.3V-70 A<br>GPS Vehicle mounted positioning communication terminal   |
| <b>Electrical system</b>   | Backup camera ○   |

|  Superstructure | Configuration  |
|--|--|
|  | Designed and manufactured by XCMG; made of high-strength steel ●   |
| <b>Hydraulic system</b>  | Exclusive matching throttle with compensation afterwards and load-sensitive technology results in the higher stability of the lowest system flow, more reasonable system rigidity, more outstanding fine control and smoothness. With double-pump confluence of hoisting, elevating and telescoping, the working speed of main and auxiliary winch can reach 135m/min, which improves the working efficiency greatly. The distribution of flow in actuators is more optimized when conducting compound movements and the working efficiency is more outstanding. ● |
| <b>Operating mode</b>  | Hydraulic control ●<br>Mechanical control ○  |
| <b>Main winch system</b>   | Hydraulic controlled speed regulation, groove drum is equipped, driven by hydraulic motor through planetary gear reducer, and built-in normally closed brake and counterbalance valve are available. ●   |
| <b>Auxiliary winch system</b>  | Hydraulic controlled speed regulation, groove drum is equipped, driven by hydraulic motor through planetary gear reducer, and built-in normally closed brake and counterbalance valve are available. ●   |
| <b>Slewing system</b>  | Four-point ball contact slewing ring. Slewing system is driven by hydraulic motor with planetary gear reducer, for 360° continuous rotation, stepless slewing speed regulation is available. Horn button is equipped on the control lever. ●   |
| <b>Elevating System</b>  | Single-supported double acting front-mounted hydraulic elevating cylinder, with balance valve equipped. ●  |
| <b>Operator's cab</b>  | Ergonomic cab design, with a sliding door (when hydraulic control), safety glass, sun visor, adjustable seats and protective rails equipped. Fan is standard and air-conditioner is standard. ●<br><br>Ergonomic cab design, with a swing-out door (when mechanical control) , safety glass, sun visor, adjustable seats and protective rails equipped. Fan is standard and air-conditioner is standard. ○   |
| <b>Safety devices</b>  | Hydraulic balance valve; Hydraulic relief valve; Double-way hydraulic valve; LMI; spring aligning device for joystick; Lowering limiter for preventing wire rope from over-releasing; Anti-two block at boom head for preventing wire rope from over-winding; tri-color warning lamp. ●  |
| <b>Counterweight</b>   | 5 t ●  |

## 技术规格

## Technical specifications

|  Boom system  | Configuration |
|---|---------------|
| <b>Boom</b> 4-section, U-shape cross section, welding structure. Boom length:10.6m ~ 35m.   | ●             |
| <b>Single top</b> Single pulley, fitted on boom head, used for single line operation.Its lifting performance is the same as that for boom, but could not exceed 3t. | ●             |
| <b>Jib</b> 1-section, Lattice jib, welded structure. Three offset angles of 0° , 15° and 30° . Fixed jib length: 9m   | ●             |

Product parts details As mentioned above, please refer to the product quotation for specific parts.

Symbol illustration :

- — standard configuration
- — optional configuration

## 重量 Weight





| 车桥<br>Axle | 1   | 2     | 3     | 总重量<br>Total weight |
|------------|-----|-------|-------|---------------------|
| t          | 6.3 | 11.95 | 11.95 | 30.2                |







| 吊钩<br>Hook | 倍率<br>No. of lines | 吊钩重量<br>Weight kg | 吊钩尺寸<br>Dimensions mm | 备注<br>Remarks                |
|------------|--------------------|-------------------|-----------------------|------------------------------|
| 25t        | 8                  | 260               | 366×430×1252          | 单钩 Single hook , 标配 Standard |
| 3t         | 1                  | 60                | 236×236×503           | 单钩 Single hook , 标配 Standard |

## 作业速度 Working speeds



|  |  |  |
|--|--|--|
| 11.00-20<br>315/80 R 22.5  | 2.5 ~ 90 km/h  | 40%  |



| 作业机构<br>Drive  | 作业速度<br>Working speed  | 最大单绳拉力<br>Max. single line pull | 钢丝绳直径/长度<br>Rope diameter/ length |
|--|--|---------------------------------|-----------------------------------|
|  | 0-135 m/min, 单绳, 第四层<br>m/min, single line, 4th layer                | 30 kN                           | 16 mm/150 m                       |
|  | 0-135 m/min, 单绳, 第四层<br>m/min, single line, 4th layer                | 30 kN                           | 16 mm/100 m                       |
|  | 0-2.5 r/min  |                                 |                                   |
|  | 从-2°抬起至79°约37s<br>Approx. 37s for boom elevation from -2° to 79°     |                                 |                                   |
|  | 从10.8m伸出至35m约55s<br>Approx. 55s for boom extension from 10.8m to 35m |                                 |                                   |



## 臂架组合方案

### Boom / Jib combinations



主臂  
Telescopic boom

T : 10.8~35m

副臂  
Jib



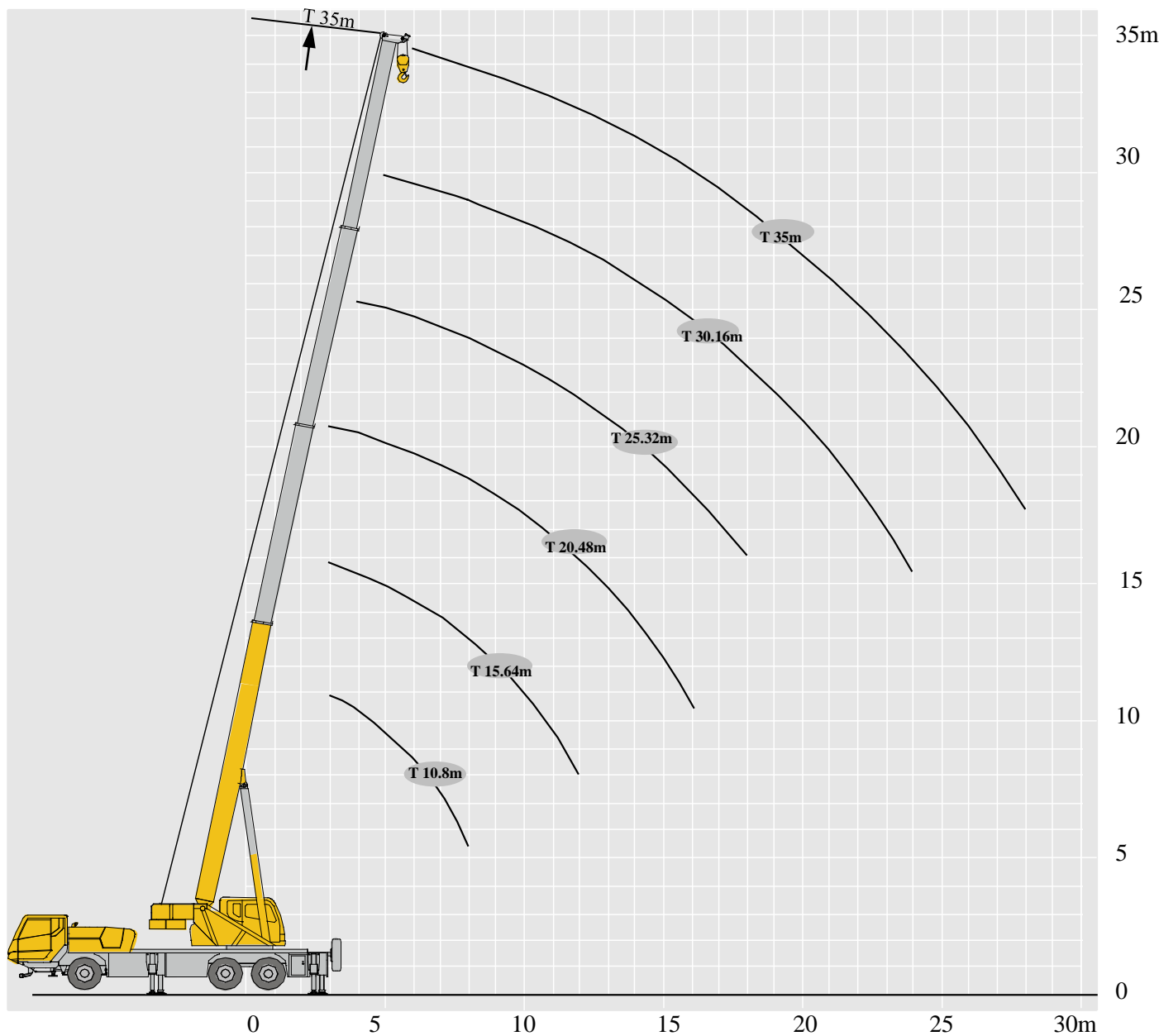

T : 10.8~35m  
J : 9 m



# 起重性能表

## Lifting capacities

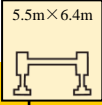
T 10.8~35.0m

|  |  10.8-35.0m |  5.5m×6.4m |  360° |        |         |      |  |
|--|--|---|--|--------|---------|------|---|
|  | 10.8m  | 15.64 m   | 20.48m   | 25.32m | 30.16 m | 35 m |   |
| 3  | 25000  |   |  |        |         |      | 3   |
| 3.5  | 25000  | 19000   |  |        |         |      | 3.5   |
| 4  | 24500  | 19000   | 18200  |        |         |      | 4   |
| 4.5  | 23200  | 19000   | 18200  |        |         |      | 4.5   |
| 5  | 22000  | 19000   | 18200  | 12500  |         |      | 5   |
| 5.5  | 21500  | 19000   | 18000  | 12000  |         |      | 5.5   |
| 6  | 19500  | 18400   | 17000  | 12000  | 9000    |      | 6   |
| 6.5  | 16200  | 16800   | 16000  | 11500  | 8800    |      | 6.5   |
| 7  | 14600  | 15200   | 15000  | 11000  | 8600    | 7300 | 7   |
| 8  | 11500  | 13000   | 13600  | 10200  | 8300    | 7200 | 8   |
| 9  |  | 10900   | 11200  | 9500   | 8000    | 6700 | 9   |
| 10   |  | 9100  | 9400   | 9000   | 7000    | 6100 | 10  |
| 12   |  | 6700  | 7000   | 7000   | 6300    | 5200 | 12  |
| 14   |  |   | 5400   | 5400   | 5500    | 4400 | 14  |
| 16   |  |   | 4200   | 4300   | 4400    | 3800 | 16  |
| 18   |  |   |  | 3400   | 3500    | 3400 | 18  |
| 20   |  |   |  | 2800   | 2900    | 2900 | 20  |
| 22   |  |   |  | 2300   | 2400    | 2400 | 22  |
| 24   |  |   |  |        | 2000    | 2000 | 24  |
| 26   |  |   |  |        | 1600    | 1700 | 26  |
| 28   |  |   |  |        |         | 1400 | 28  |
| 30   |  |   |  |        |         | 1200 | 30  |

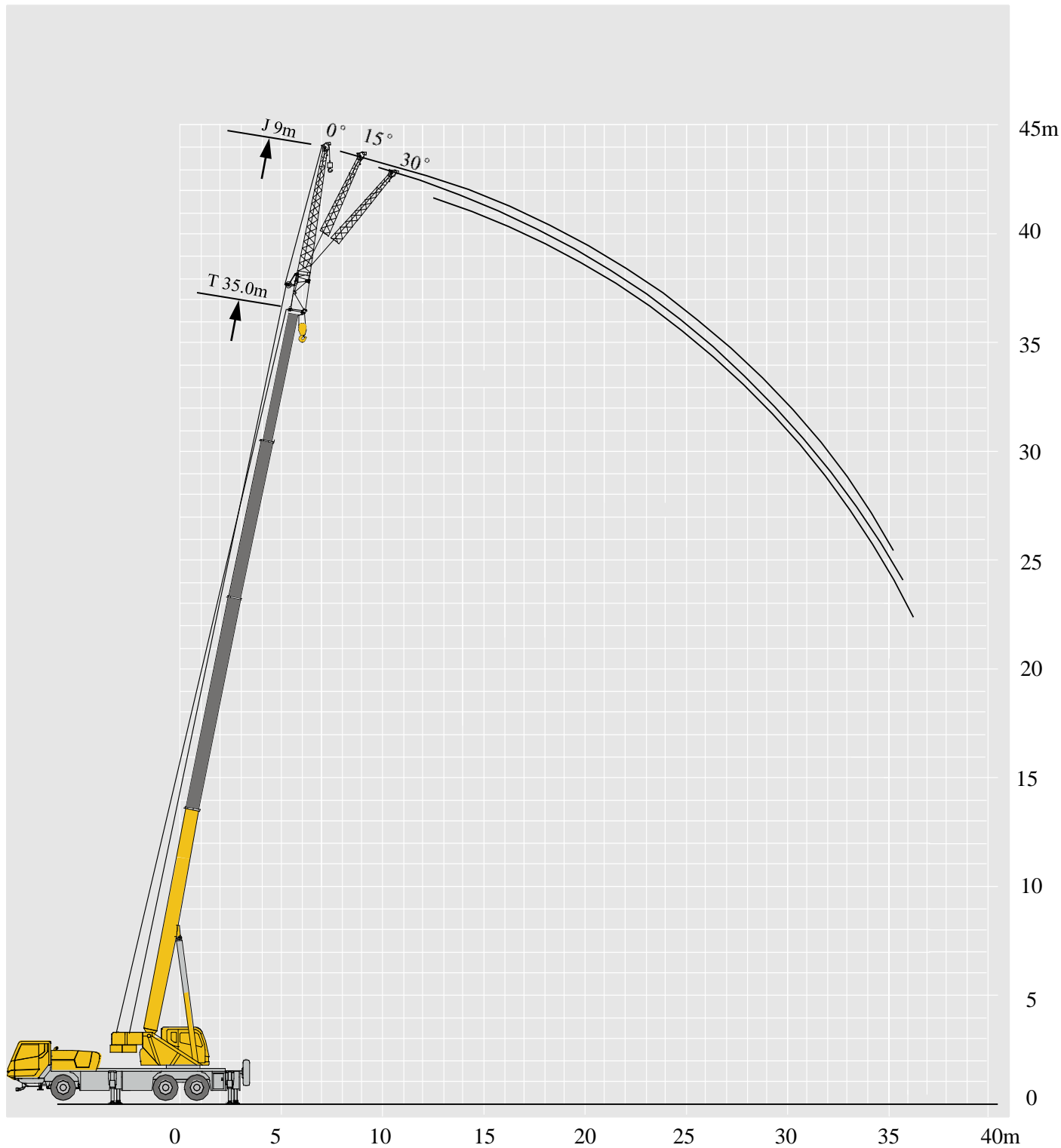

# 起重性能表

## Lifting capacities

T 35.0m

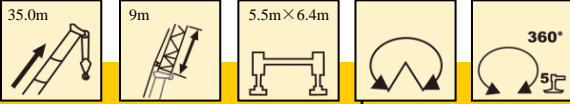

|    | 0°   | 15°  | 30°  |    |
|----|------|------|------|----|
| 78 | 3000 | 3000 | 2400 | 78 |
| 75 | 3000 | 2800 | 2300 | 75 |
| 72 | 3000 | 2600 | 2100 | 72 |
| 70 | 2800 | 2500 | 2000 | 70 |
| 65 | 2800 | 2400 | 1800 | 65 |
| 60 | 2300 | 2000 | 1800 | 60 |
| 55 | 1700 | 1600 | 1500 | 55 |
| 50 | 1300 | 1300 | 1200 | 50 |
| 45 | 1000 | 800  | 600  | 45 |

# 注意事项

## Notes

1. 表中额定总起重量值，是在平整的坚固地面上本起重机能够保证的最大总起重量，包括吊钩和吊具的重量，所以为了估算重物重量，必须减去上述的装置重量。
2. 表中的工作幅度为起吊重物离地时起重物到起重机回转轴线的水平距离，是包括起重臂变形量在内的实际值，因而起吊前应考虑起重臂变形量。
3. 只允许在5级(瞬时风速14.1m/s，风压125N/m<sup>2</sup>)风以下进行作业。
4. 吊重前操作者必须对物体的重量和工作范围了解后选择合适的作业工况，严禁超出表中的数值。幅度及臂长在相邻两个数值之间时，应依据两个数值中较小值确定起重作业。
5. 应按主臂仰角范围作业，即使是空载，也不应使主臂仰角处于范围外，谨防整机倾翻。
6. 表中的主臂长度应要按照每节臂的伸缩要求进行伸出。

1. The total rated loads given in the rated load charts are the maximum lifting capacity when the crane is set up on firm and level ground, which includes the weight of the hook block and slings. The weight of above-mentioned devices should be deducted to correctly calculate the load weight.
2. The working radius shown in the rated load charts is the radius when the load is lifted off the ground, and it is the actual value including loaded boom deflection.
3. A lifting operation is permissible only when the wind force is below grade 5 (instantaneous wind speed is 14.1 m/s, wind pressure is 125 N/m<sup>2</sup>).
4. Before beginning lifting operation, the operator should know the weight of the load to be lifted and its working range, and then select proper working conditions. Never operate the crane beyond the limit shown in the chart. Use the lower value from the chart when the boom length or working radius is between the range of values.
5. Observe the boom angle limit. Never operate the crane with the boom angle beyond the recommended limit even if a load is not being carried. Otherwise, the crane will tip.
6. The boom length given in the rated load charts should accord with the telescoping code of boom sections .

# 符号标识

## Description of symbols

### 常规标识

#### General symbols

|  |                                  |   |   |
|--|----------------------------------|---|---|
|    | 上车<br>Superstructure             |    | 底盘<br>Chassis                                       |
|    | 起重能力<br>lifting capacity         |    | 车桥<br>Axle  |
|    | 吊臂长度<br>Boom length              |    | 行驶速度<br>Driving speed                               |
|    | 工作幅度<br>Radius                   |    | 爬坡能力<br>Gradability                                 |
|    | 吊臂仰角<br>Boom position            |    | 轮胎<br>Tyres   |
|   | 主臂起升高度<br>Hoist height with Boom |   | 支腿<br>Outriggers                                    |
|  | 固定副臂长度<br>Fixed jib length       |  | 吊钩<br>Hook block                                    |
|  | 副臂安装角<br>Jib offset angle        |  | 卷扬<br>Winch   |
|  | 副臂起升高度<br>Hoist height with jib  |  | 使用第五支腿360°全回转<br>360° rotation with 5th jack        |
|  |                                  |  | 不使用第五支腿侧后方作业<br>Over side or over rear of the crane |

# 主要技术参数表

## Transportation plan

| 类别<br>Category     | 项目<br>Item   | 单位<br>Unit  | 参数<br>Parameter           |       |
|--------------------|--|-------------|---------------------------|-------|
| 尺寸参数<br>Dimensions | 外形尺寸 (长×宽×高)<br>Outline size (length×width×height)   | mm          | 12940×2550×3400           |       |
|                    | 轴距<br>Wheel base                                     | mm          | 4500+1350                 |       |
|                    | 轮距 (前/后)<br>Track (Front/ Rear)                      | mm          | 2059 (汉德)、2074 (美驰) /1834 |       |
|                    | 前悬/后悬<br>Front/ Rear overhang                        | mm          | 2526 (南汽)、2539 (齐星) /2540 |       |
|                    | 前伸/后伸<br>Front/ Rear extension                       | mm          | 1669 (南汽)、1656 (齐星) /355  |       |
| 重量参数<br>Weight     | 最大允许总质量<br>Total weight in travel                    | kg          | 30200                     |       |
|                    | 轴荷<br>Axle load                                      | 一轴 1st axle | kg                        | 6300  |
|                    |  | 二轴 2nd axle | kg                        | 11950 |
|                    |  | 三轴 3rd axle | kg                        | 11950 |
| 动力参数<br>Power      | 发动机型号<br>Engine model                                | —           | SC9DF300.1Q5              |       |
|                    | 额定功率/转速<br>Engine rated power/rpm                    | kW/(r/min)  | 221/2200                  |       |
|                    | 最大净功率/转速<br>Max. net power/rpm                       | kW/(r/min)  | 219/2200                  |       |
|                    | 最大输出扭矩/转速<br>Engine rated torque/rpm                 | N.m/(r/min) | 1250/1400                 |       |
| 行驶参数<br>Travel     | 最高车速<br>Max. travel speed                            | km/h        | ≥90                       |       |
|                    | 最低稳定车速<br>Min. travel speed                          | km/h        | 2.5 ~ 3                   |       |
|                    | 最小转弯直径<br>Min. turning diameter                      | m           | ≤21                       |       |
|                    | 臂头最小转弯直径<br>Min. turning diameter at boom tip        | m           | ≤27                       |       |
|                    | 最小离地间隙<br>Min. ground clearance                      | mm          | 250                       |       |
|                    | 接近角<br>Approach angle                                | °           | 11                        |       |
|                    | 离去角<br>Departure angle                               | °           | 13.5                      |       |
|                    | 制动距离 (制动初速度为30km/h)<br>Braking distance (at 30 km/h) | m           | ≤10                       |       |
|                    | 最大爬坡能力<br>Max. grade ability                         | %           | ≥40                       |       |
|                    | 百公里油耗<br>Fuel consumption per 100 km                 | L           | 28                        |       |
| 噪音<br>Noise        | 加速行驶机外噪声<br>Exterior noise level                     | dB(A)       | ≤84                       |       |
|                    | 驾驶员耳旁噪声<br>Noise level at seated position            | dB(A)       | ≤90                       |       |



# 主要技术参数表

## Transportation plan

| 类别<br>Category   | 项目<br>Item  |                                      | 单位<br>Unit   | 参数<br>Parameter |     |
|--|---|--------------------------------------|--------------|-----------------|-----|
| 主要性能参数<br>Main performance   | 最大额定总起重量 Max. total rated lifting capacity        |                                      | t            | 25              |     |
|  | 最小额定工作幅度 Min. rated working radius                |                                      | m            | 3               |     |
|  | 转台尾部回转半径<br>Turning radius at turntable tail      | 平衡重处 Counterweight                   | mm           | 3550            |     |
|  |   | 副卷处 Auxiliary winch                  | mm           | —               |     |
|  | 最大起重力矩<br>Max. load moment                        | 基本臂<br>Base boom                     | kN.m         | 1159            |     |
|  |   | 最长主臂<br>Fully-extended boom          | kN.m         | 612             |     |
|  |   | 最长主臂+副臂<br>Fully-extended boom + Jib | kN.m         | 521             |     |
|  | 支腿跨距<br>Outrigger span                            | 纵向 Longitudinal                      | m            | 5.5             |     |
|  |   | 横向 Lateral                           | m            | 6.4             |     |
|  | 起升高度<br>Hoist height                              | 基本臂<br>Base boom                     | m            | 10.2            |     |
|  |   | 最长主臂<br>Fully-extended boom          | m            | 34.3            |     |
|  |   | 最长主臂+副臂<br>Fully-extended boom + Jib | m            | 43.4            |     |
|  | 起重臂长度<br>Boom length                              | 基本臂<br>Base boom                     | m            | 10.8            |     |
|  |   | 最长主臂<br>Fully-extended boom          | m            | 35.0            |     |
|  |   | 最长主臂+副臂<br>Fully-extended boom + Jib | m            | 44.0            |     |
| 副臂安装角 Jib offset angle   |   | °                                    | 0、15、30      |                 |     |
| 工作速度参数<br>Working speed  | 起重臂起臂时间 Boom raising time                         |                                      | s            | ≤37             |     |
|  | 起重臂全伸时间 Boom fully extended time                  |                                      | s            | ≤55             |     |
|  | 最大回转速度 Max. slewing speed                         |                                      | r/min        | ≥2.5            |     |
|  | 支腿收放时间<br>Outrigger extending and retracting time | 水平支腿<br>Outrigger beam               | 收 Retracting | s               | ≤20 |
|  |   |                                      | 放 Extending  | s               | ≤30 |
|  |   | 垂直支腿<br>Outrigger jack               | 收 Retracting | s               | ≤20 |
|  |   |                                      | 放 Extending  | s               | ≤35 |
| 起升速度 (单绳,第四层,空载)<br>Hoisting speed (single line, 4th layer, no load) | 主起升机构 Main winch                                  | m/min                                | ≥135         |                 |     |
|  | 副起升机构 Auxiliary winch                             | m/min                                | ≥135         |                 |     |
| 噪声<br>Noise  | 机外辐射 Exterior noise level                         |                                      | dB ( A )     | ≤108            |     |
|  | 司机位置处 Noise level at seated position              |                                      | dB ( A )     | ≤85             |     |



该水印由迅读PDF生成，  
如果想去掉该水印，请访问并下载：  
<http://www.pdfxd.com>

迅读PDF大师



地址：江苏省徐州市经济技术开发区高新路68号  
Add : No. 68 Gaoxin Road,  
Economic and Technological Development Zone,  
Xuzhou, Jiangsu, China  
电话(Tel) : +86-13585395642  
邮编 (Post Code): 221000  
网址 (Web): [www.xcmg.com/qizhongji](http://www.xcmg.com/qizhongji)

服务热线 Service Tel

400-110-9999

400-001-5678



本印刷品不属于合同。出于产品不断改进的需要，我们保留对产品型号、参数、配置进行变更的权利，恕不另行通知。图片仅供参考，具体产品以实物为准。图片中产品可能并非标准配置，部分部件可能需要另行购置。办理牌照和上路行驶需遵守当地法规。

This print does not belong to the contract. We reserve the right to modify the design (such as product model, parameters and configuration) without notice for improvement. The pictures are just for reference. The product in the picture may not be standard configuration. Some parts need to be purchased separately. Conform to the local laws for license application and road traveling.

XCMG—QY25KC