

Link-Belt Speeder

# YC CRANES

All-Hydraulic / Self-Propelled

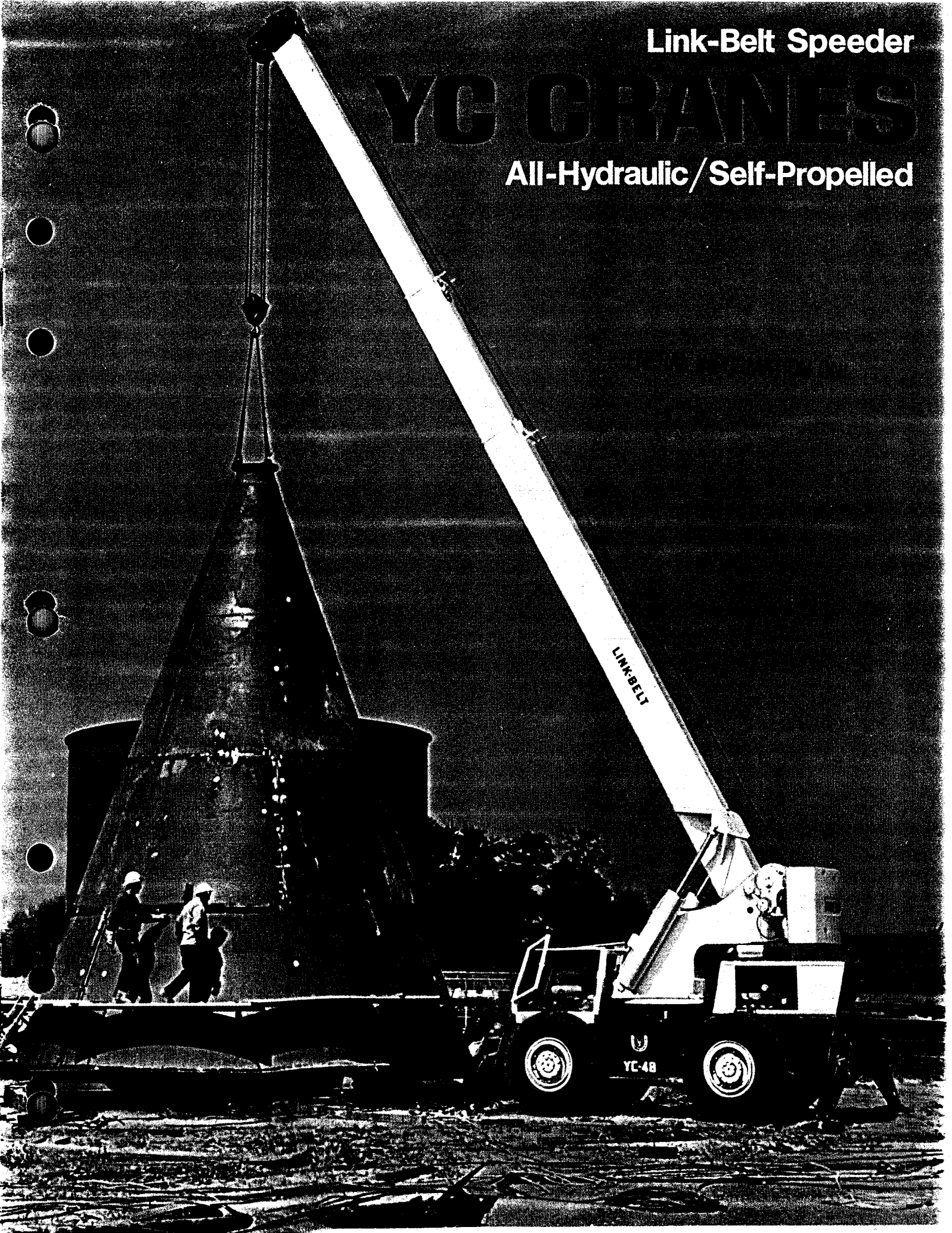

# The New Dimension In Hydraulic Self-Propelled Cranes

*A Model To Fit Your Job Requirements*

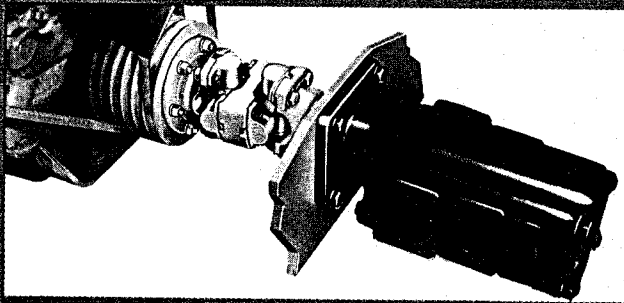

## HYDRAULIC PUMP AND DRIVE:

Each crane is equipped with a hydraulic pump and drive mechanism. The pump is driven by the engine and provides the hydraulic power for the crane's hydraulic system. The drive mechanism is designed to reduce vibration and noise.

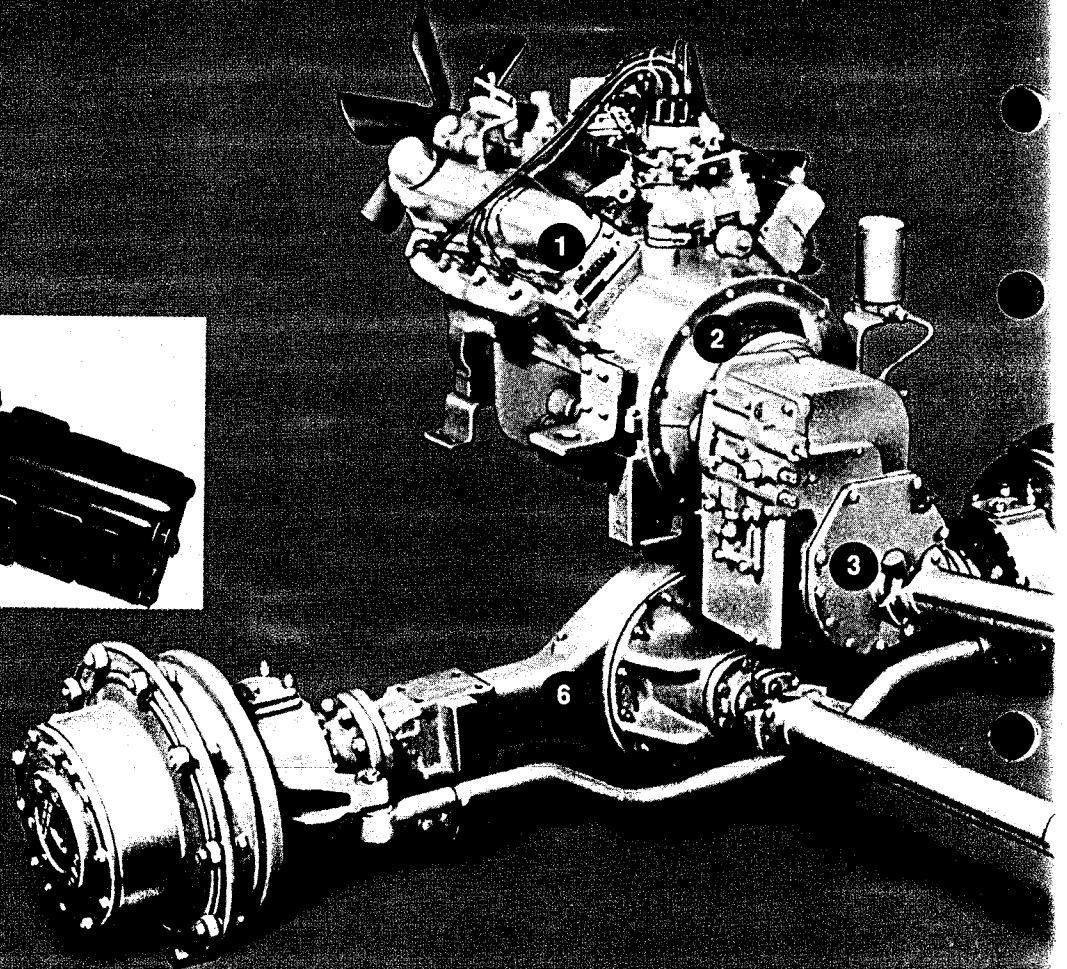

- 1 ENGINE:** Standard 6-cylinder, variable speed engine.
- 2 TORQUE CONVERTER:** Torque converter with planetary gear set and lock-up clutch. Allows shifting into high gear while travelling.
- 3 TRANSMISSION, POWER SHIFT:** Overhead control, planetary gear set, and lock-up clutch. Allows shifting into high gear while travelling.

- 4 TRANSMISSION, MECHANICAL:** Standard 6-speed, manual transmission with lock-up clutch. Allows shifting into high gear while travelling.
- 5 REAR AXLE DISCONNECT:** Disconnects rear axle from engine for low speed operation.

- 6 REAR AXLE:** Rear axle drive with planetary gear set and lock-up clutch. Allows shifting into high gear while travelling.
- 7 BRAKE, PARKING:** Parking brake applied from operator's seat. Released from driver's seat.
- 8 FRONT AXLE:** Front axle drive with planetary gear set and lock-up clutch. Allows shifting into high gear while travelling.

# Compatible Power Train Component Design

*Carefully Selected For Durability And Mobility*

GENERAL INFORMATION ONLY

Link-Belt Speeder offers a line of YC model all-hydraulic, self-propelled cranes. Each is engineered with traditional Link-Belt Speeder quality.

The travel-steer power train components are carefully selected and matched for durability and mobility with or without load, over even or uneven terrain, on and to the job site.

Gasoline or diesel engines available. A torque converter is standard for smoother travel acceleration. The converter powers a high/low range power-shift transmission controlled by a lever to the right of the operator. Power shifts the transmission from low to high range speed while traveling . . . no need to stop the machine. Also controls forward-reverse travel with single level to left of operator.

From the power shift transmission, power is to a combination dual-range and synchro-mesh transmission. Upper transmission has dual range on smaller models with high range for travel off the job site. The lower transmission is a 2-speed, synchro-mesh, controlled by foot pedal and shift lever. The YC model cranes are designed with an over-all speed selection necessary to meet the variable job conditions.

Power from the synchro-mesh transmission is to the front and rear axles and into the planetary driven wheels. Four-wheel drive is standard. For long distance, over-the-road travel, the rear axle may be disconnected to prevent unnecessary axle wear. Optional no-spin differential on either or both axles. Four-wheel hydraulic brakes and **hydraulic steer** are standard. Larger models use two hydraulic steer cylinders per axle.

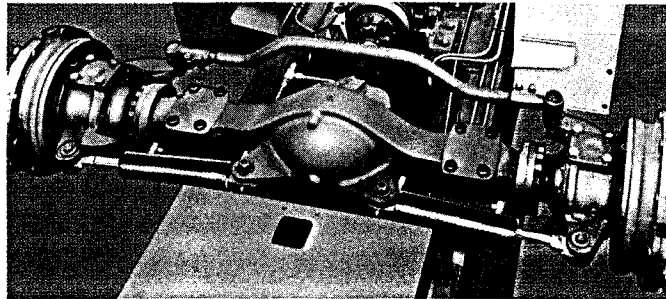

Hydraulic Steer

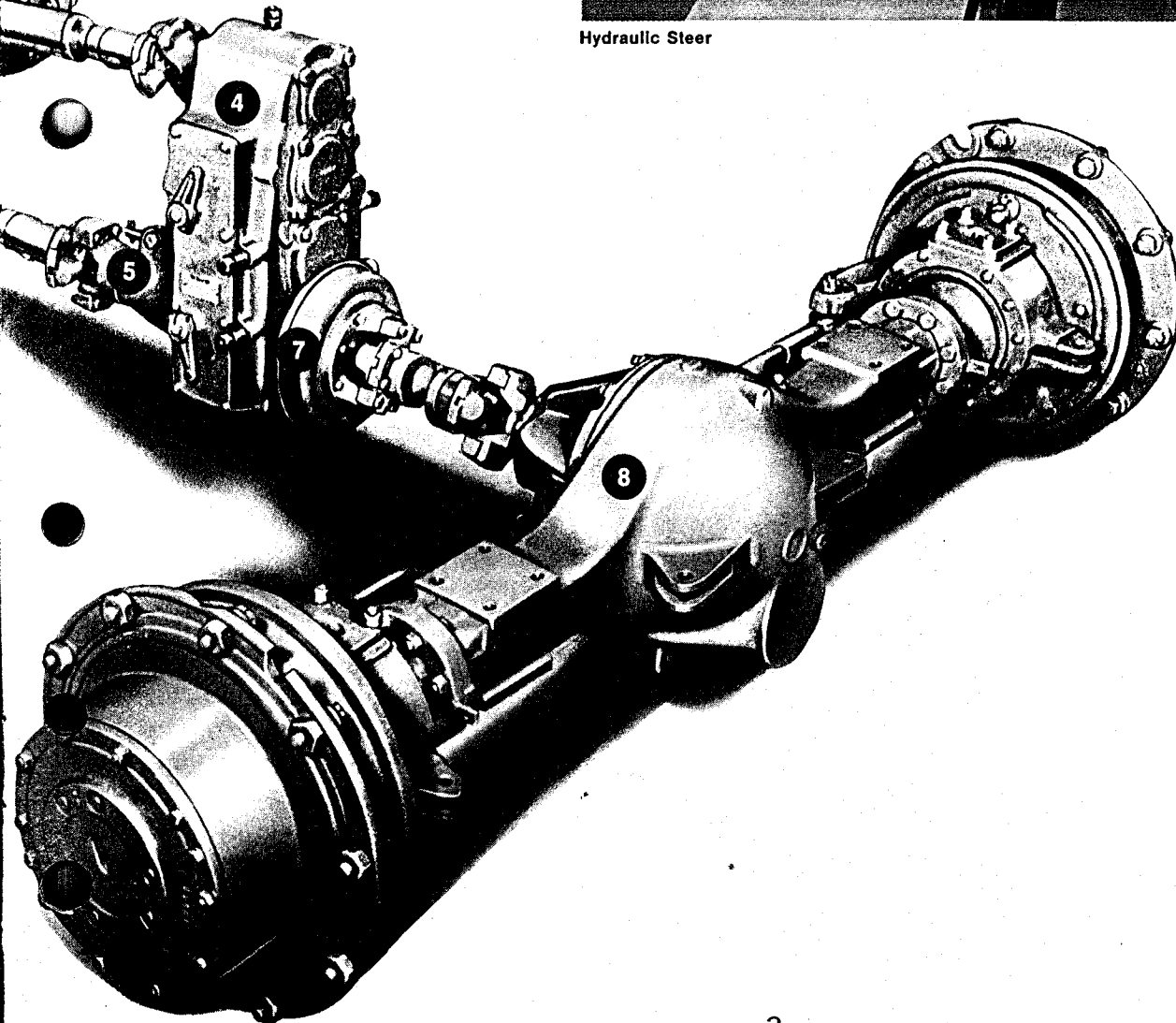

# Fast, Efficient Crane Mounted On Capable Carrier

*Link-Belt Speeder Designed Swing And Hoist Speed Reducer*

The YC model hydraulic crane design is an engineered combination of an efficient crane (swing, hoist, boom extend-retract, and boom hoist) mounted on a capable carrier for a durable crane lifting base. Outriggers are hydraulically controlled, hinge-type. Outrigger boxes are welded integral to an alloy main frame. Pontoons are hinged to outrigger arms. Once the outriggers are set, a **check valve** fixed to the cylinder "locks" the oil in the cylinder and the outriggers in place.

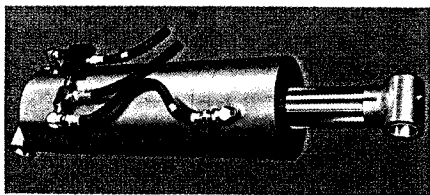

1. Outrigger Cylinder Check Valve

The swing control valve, with cross-over relief valve, results in smooth acceleration and deceleration of swing. The crane upper revolving frame is mounted to the carrier by a **turntable bearing (A)**. Swing power is from the 2-directional hydraulic motor into the Link-Belt Speeder fully enclosed gear speed reducer and then into the swing shaft/pinion. Swing brake is standard . . . holds upper and boom at any swing position. Swing brake is spring applied and power hydraulically released.

Power hydraulic **boom hoisting and lowering** is through two double-act-

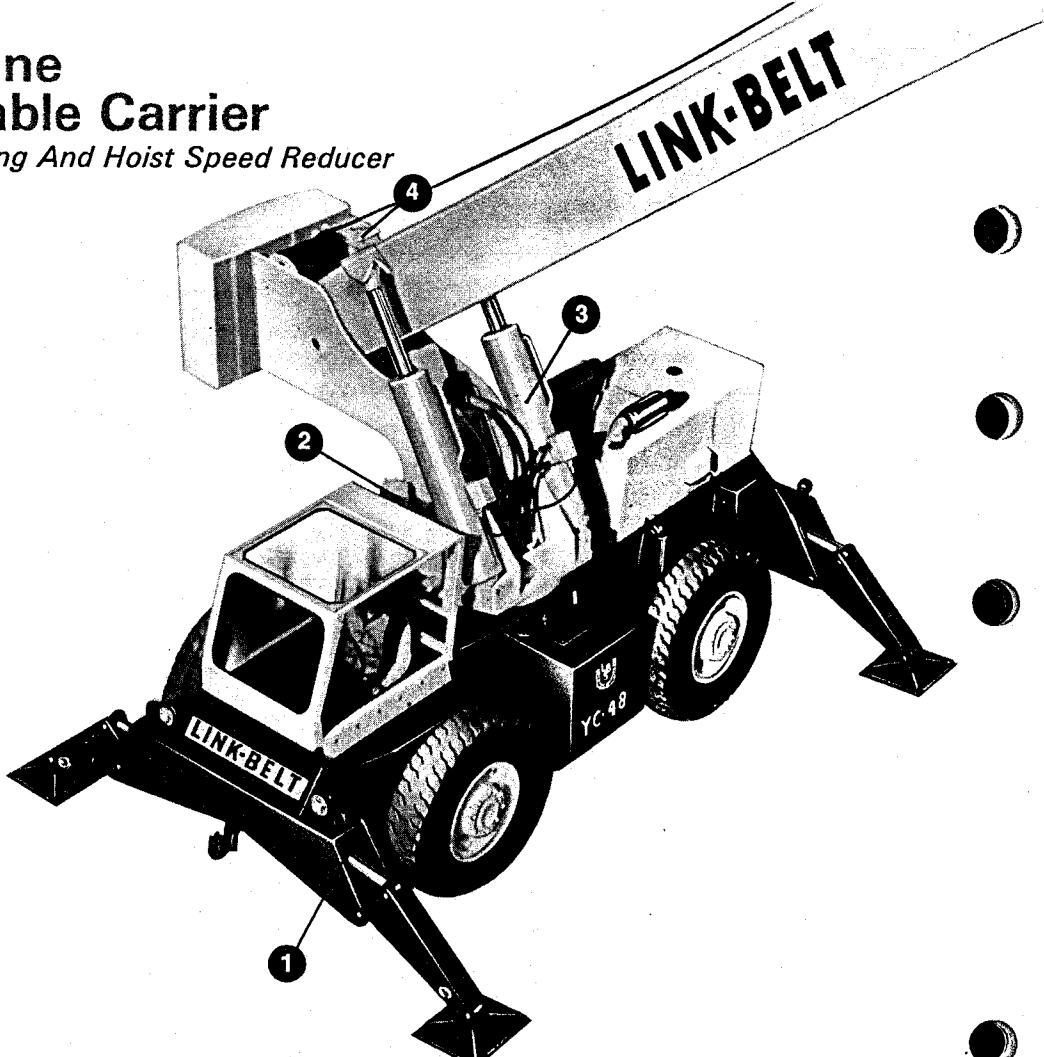

ing cylinders mounted in self-aligning bushings. Each cylinder is equipped with an integral check valve **(B)** to hold boom in position when operator control lever is in neutral or when the engine is shut off. Holding valve **(C)** allows controlled lowering of the boom.

The YC model line features power hydraulic **load hoisting** and lowering through a 2-directional motor into the

Link-Belt Speeder gear speed reducer and into the rope drum. Hoist speed reducer is interchangeable with the swing speed reducer. A hoist brake, mounted on hydraulic motor output shaft, is power hydraulically released when operator engages hoist control lever. Brake is spring applied when control lever is returned to neutral. A holding valve prevents uncontrolled lowering of high line pull loads.

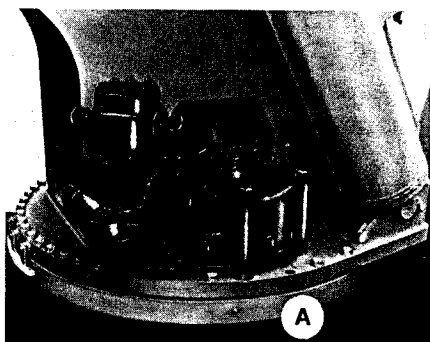

2. Swing

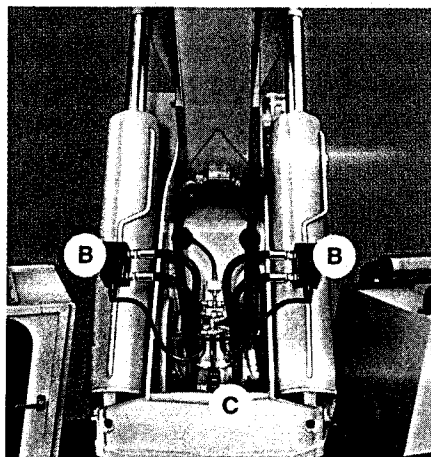

3. Boomhoist And Lowering

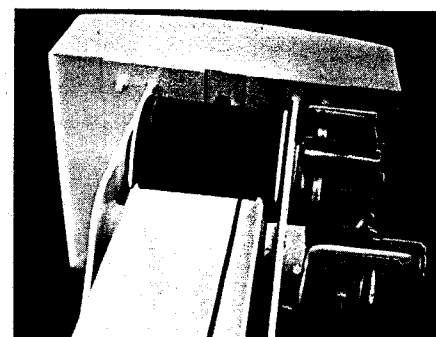

4. Load Hoist

GENERAL INFORMATION ONLY

# Convenient Operator Control Arrangement

Adds To Machine's Over-All Performance

GENERAL INFORMATION ONLY

The operator controls and instrument panel are designed for ease of operation, comfort, and efficiency. Operator works from a contoured, foam-padded, bucket-type seat. Convenient location of the various operating levers add to the machine's over-all performance.

Optional cab has tinted, overhead glass to reduce glare. Other optional items include cab doors, electric windshield wiper, cab heater, fan-type defroster, head and tail lights, and turn signals.

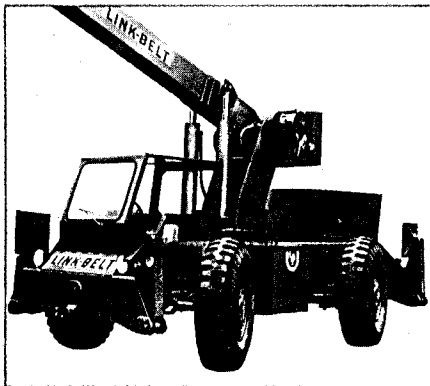

Independent Front/Rear Wheel Steering

For short-radius turns and over-all on-the-job maneuverability, independent front and rear wheel steering is standard. For operator convenience, a steering wheel controls front-wheel steer (item #15). Dash-mounted lever (item #16) controls rear wheel steer. Front and rear wheel steer cylinders are interchangeable.

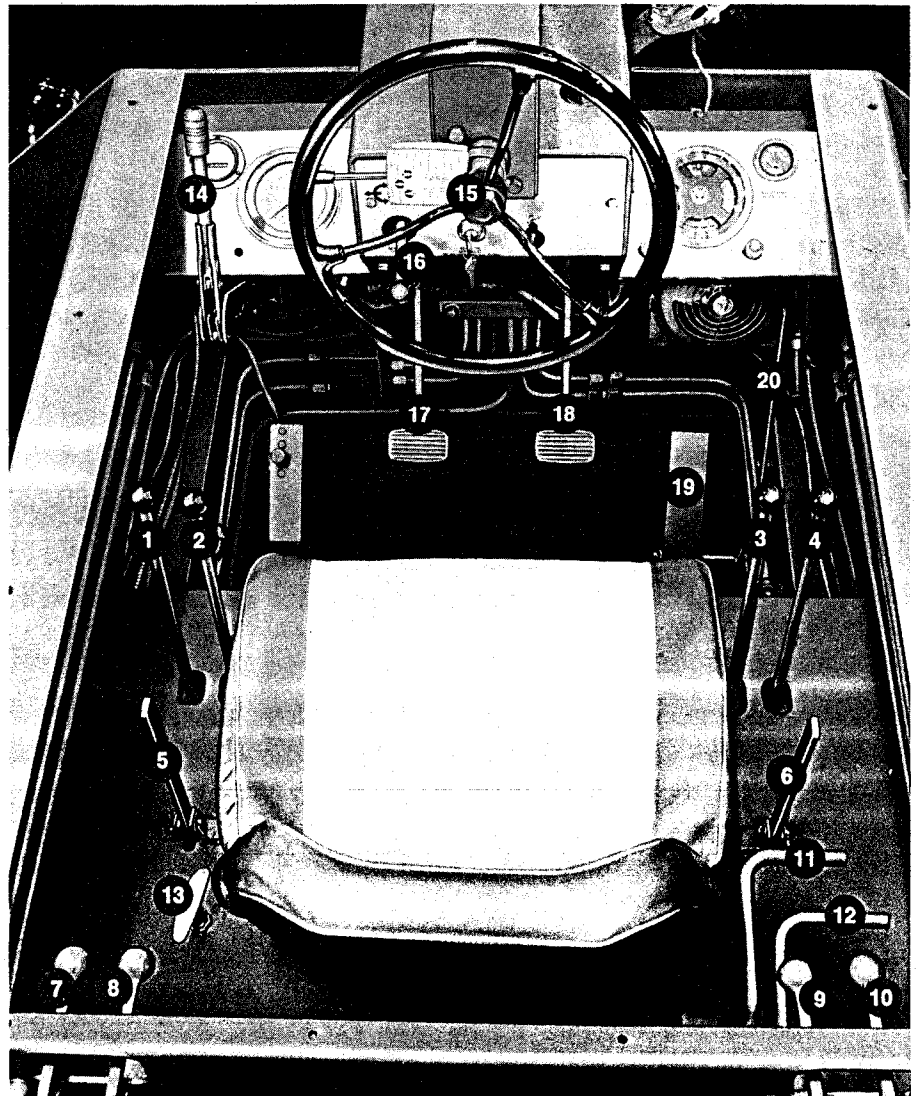

## Operator Controls

- |                           |                             |
|---------------------------|-----------------------------|
| 1. SWING                  | 11. RANGE SHIFT HI/LO       |
| 2. BOOMHOIST              | 12. SYNCHRO-SHIFT TWO SPEED |
| 3. BOOM EXTEND/RETRACT    | 13. REAR AXLE DISCONNECT    |
| 4. CABLE HOIST/LOWERING   | 14. PARKING BRAKE           |
| 5. POWERSHIFT, FWD./REV.  | 15. FRONT POWER STEER       |
| 6. POWERSHIFT, HI/LO      | 16. REAR POWER STEER        |
| 7. LEFT FRONT OUTRIGGER   | 17. FOOT PEDAL              |
| 8. LEFT REAR OUTRIGGER    | 18. SERVICE BRAKE           |
| 9. RIGHT REAR OUTRIGGER   | 19. FOOT THROTTLE           |
| 10. RIGHT FRONT OUTRIGGER | 20. HAND THROTTLE           |

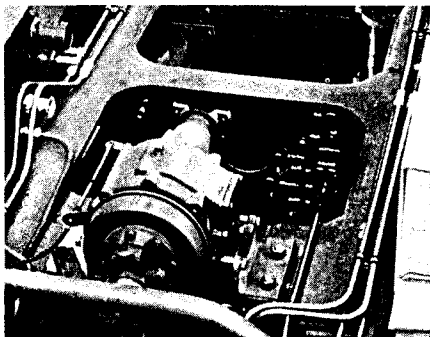

Main Control Valves

The main operating control valves are readily accessible from underneath the main frame and are controlled through mechanical linkage for precise, positive function control. Tandem-type pump provides hydraulic power to the control valves.

# Full Power 2-Section And 3-Section Booms Manual Extensions And Jib Available

*Boom Extension System For Optimum Lifting Capacity*

The Link-Belt Speeder YC model cranes are equipped with full power telescoping booms (2-section or 3-section). For additional reach, manual boom extensions and jibs are available. Single cylinder extends-retracts the 2-section booms and **exclusive twin-cylinder arrangement** extends 3-section booms. All cylinders are double acting with cylinder rods remaining stationary and cylinder case extending-retracting. The twin cylinders eliminate the need for long hoses and hose reels.

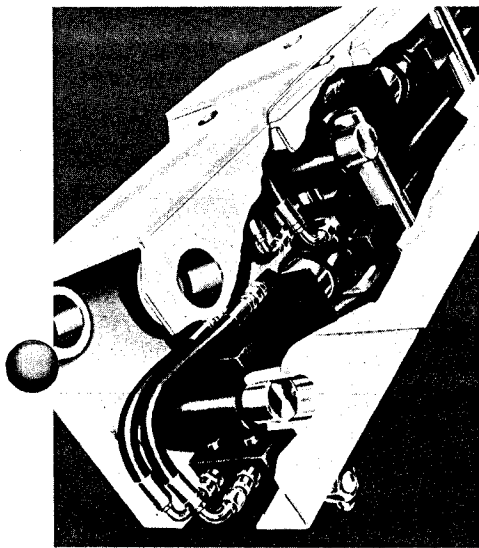

**Exclusive Cylinder Design**

The boom sections are box-type construction, high strength, low alloy steel. The 3-section boom extension system allows the tip section (A) to extend completely before the center power section (B) starts to extend. This is accomplished by means of a **latch-lock** arrangement. The latch (C) locks center section (B) to base section (D). At the end of the tip section stroke, block (E) fixed to the top of tip section (A), will engage the base of latch (C), unlocking center section (B) and allowing it to extend fully.



**Boomhead Machinery With Jib Strut And Link Attached**

**Jib In Stored Position**

When retracting the boom, the sequence is reversed and the center power section retracts completely before the tip power section can be retracted. No need for special sequencing valves or separate boom

telescopic control levers. Only one lever is used to fully extend or retract the boom. Boom extend-retract cylinders are equipped with holding valves. Power sections are supported by and slide on Teflon impregnated shoes.

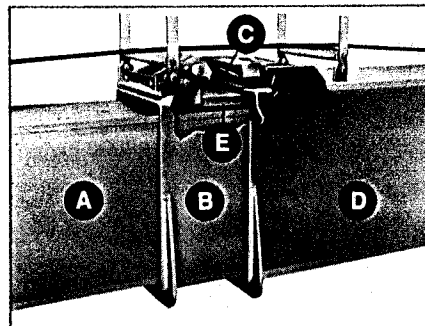

**Center Section Latch Locked**

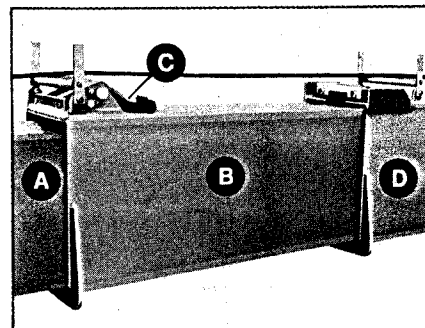

**Center Section Unlatched**

This boom extend-retract design keeps the greatest portion of the boom weight closest to the machine for optimum lifting capacities.

A boom telescope and load hoist interlock is standard. To extend the boom, operator must pay out hoist line simultaneously.

The **boomhead** machinery consists of one top and three bottom sheaves mounted on anti-friction bearings to eliminate the need for frequent lubrication. Boomhead machinery is designed for fast pinning to either the tip power section or manual boom extensions. Hoist line guide rollers are mounted on top of boom.

**GENERAL INFORMATION ONLY**

The jib is pinned to the boomhead machinery and stored under the boom base when not in use. Jib mounts to extended lower boom head shaft. Front stay lines also serve to hold jib in stored position. Jib strut and link may be left in place on boomhead.

Refer to individual model listsheets for available boom heights, manual extensions and jibs.

Counterweight is bolted to the upper revolving frame and therefore remains stationary when raising or lowering the boom.

All YC model hydraulic cranes are equipped with a rear oscillating axle for traction while traveling and for providing the wheel ground control.

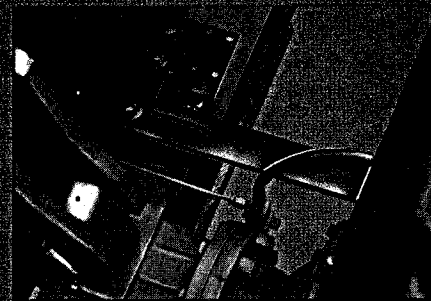

Rear wheel position indicator

when lifting "on tires" on uneven terrain. However, when operating "on tires" and swinging the crane boom beyond 15° from front centerline of machine, rear axle oscillation should be "locked out" to hold rear axle rigid. Smaller YC models are

equipped with rear axle lockout (A) which is controlled from the operator's seat.

control valve (C) open. This allows free flow of oil from the cylinder to the other through control valve (C). Rear axle is free to oscillate. When swinging crane upper beyond 15° from centerline of machine, roller (A) is not in contact with cam surface (B), closing valve (C) and preventing free flow of oil from cylinders. Rear axle is now held rigid. This arrangement allows for a "lock over the side" to "carry over the front" operation without interruption.

A rear wheel lock indicator is optional. Same as light located on the instrument panel, indicates to operator when rear wheel is other than center position. This is particularly valuable when operating machine on uneven terrain.

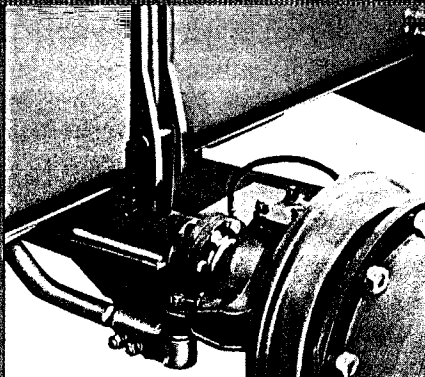

Selective rear axle lockout

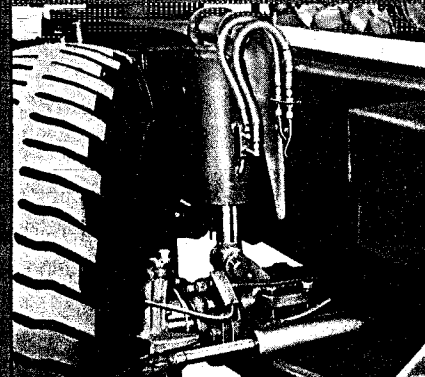

Hydraulic rear axle lockout

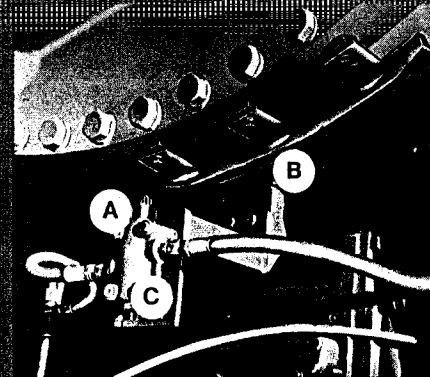

Hydraulic axle lockout control valve

On the larger models, an automatic hydraulic lockout is provided. A double-acting cylinder is mounted on each side of the main frame, cylinder end is connected to frame with rod end attached to rear axle.

When crane upper is within 15° from front centerline of machine, roller (A) is in contact with cam surface (B) on rear of hydraulic bearing, holding

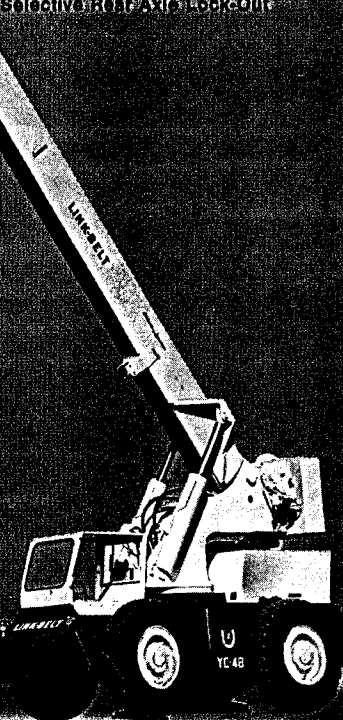

# YC Model Cranes Are Job-Proven

*In Plants, Materials Yards, Construction, Etc.*

GENERAL INFORMATION ONLY

Link-Belt Speeder YC model hydraulic self-propelled cranes offer mobility and speed. Power shift transmission plus torque converter permits fast, smooth starts. Four-wheel drive and steer offer mobility on the job. Simple boom extend-retract design eliminates the need for boom sequencing valves or multiple operator controls — one lever operation. Push for boom extend; pull for boom retract. Exclusive twin-cylinder design eliminates long hoses and hose reels.

The YC model cranes have proven themselves on a varied number and type of jobs. There is a right Link-Belt Speeder model for your job. For a new dimension in hydraulic self-propelled crane design, it's a Link-Belt Speeder.

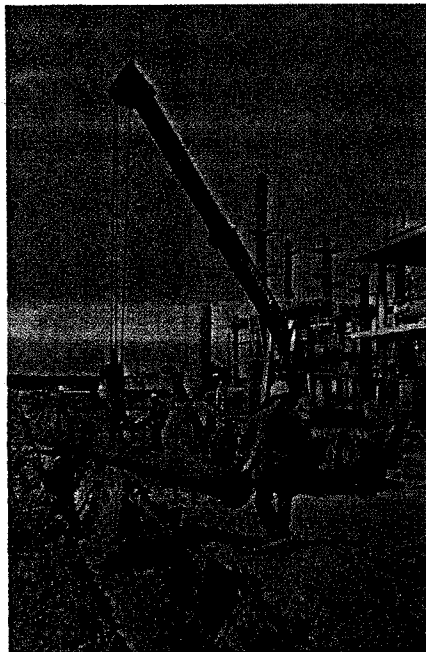

## YC Crane Features In Brief

- **4-wheel drive and steer:** For mobility on and to the job site.
- **Torque converter:** Smooth travel starts.
- **Power shift transmission:** Permits shifting into high-speed range while travelling.
- **Oscillating rear axle:** For traction while travelling.
- **Rear axle lock-outs:** For 4-wheel stability when lifting "on tires" on uneven terrain.
- **Boom extend-retract cylinder arrangement:** Eliminates need for long hoses and hose reels.
- **Holding valves on boomhoist and hoist:** For controlled boom and load lowering.

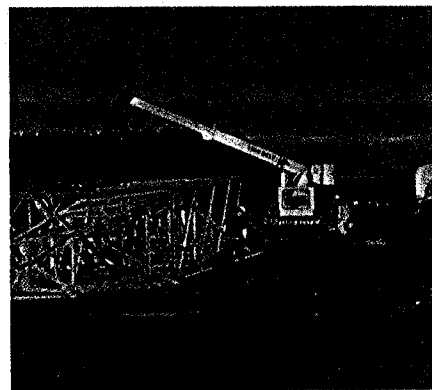

We are constantly improving our products and therefore reserve the right to change designs and specifications.



## Link-Belt Speeder

DIVISION OF FMC CORPORATION

Cedar Rapids, Iowa • Woodstock, Ontario, Canada • Queretaro, Mexico • Milan, Italy

