

CD4415

ROUGH TERRAIN CRANE



PRELIMINARY SPECIFICATION GUIDE

BIG JOB? SMALL SPACE? NO PROBLEM.

The new Badger CD4415 Rough Terrain Crane features:

- Rated capacity: 15 Ton (13.6 mT) at 10 ft. (3.0 m) working radius
- Maximum boom length: 62.5 ft. (19 m)
- Maximum tip height: 85.5 ft. (21.6 m)

CONTENTS

Key	
Key of Icons	3
Dimensions	
Crane Dimensions	4
Crane Weights	4
Preliminary Range Diagram	5
Area of Operation	6
Preliminary Load Charts	
Preliminary Load Chart – Main Boom – On Outriggers	7
Preliminary Load Chart – Main Boom – On Tires	8
Technical Description	
Boom	9
Hoist, Rope and Hook	9
Superstructure	10
Cab, Controls, Operator Aids and Load Limiter / Load Indicator	10
Carrier, Engine, Drive-line and Hydraulic System	11
Vehicle Performance	12
Tires	12



































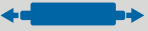









Constant improvements and engineering progress make it necessary that Badger Equipment Company reserves the right to change designs, specifications and price changes without notice or obligation.

Drawings and/or photographs in this document are for illustrative purposes only and may include optional equipment and accessories and may not include all standard equipment. This document is non-contractual.

CD4415 ROUGH TERRAIN CRANE

KEY

	Gross vehicle weight		Weight on front axle
	Weight on rear axle		Swing on jib stowed
	Standard (without hook block)		Lifting on wheels / Pick & carry
	Hook block		Distance from hook to head sheave pin
	Counterweight		Working radius
	Telescoping mode		Boom length
	Tip height		General performance
	Max. boom length with extension		Hydraulic actuated boom
	Full power mechanically synchronized		Boom elevation angle
	Boom with extension		Main hoist
	Hoist speed		Rope - Standard / Optional
	Rope diameter		Rope length
	Maximum line pull		Hook and ball
	Slewing / Allowable slewing range		Slewing locked / Slewing locked at specified position
	Slewing brake		Slewing gears
	Engine		Hydraulics
	Cab		Controls
	Heating / Air conditioning		Mechanical transmission
	Operator aids / Load limiter / Load indicator		Steering
	Outriggers / Lifting on outriggers		Tire
	Gradeability		Speed

DIMENSIONS

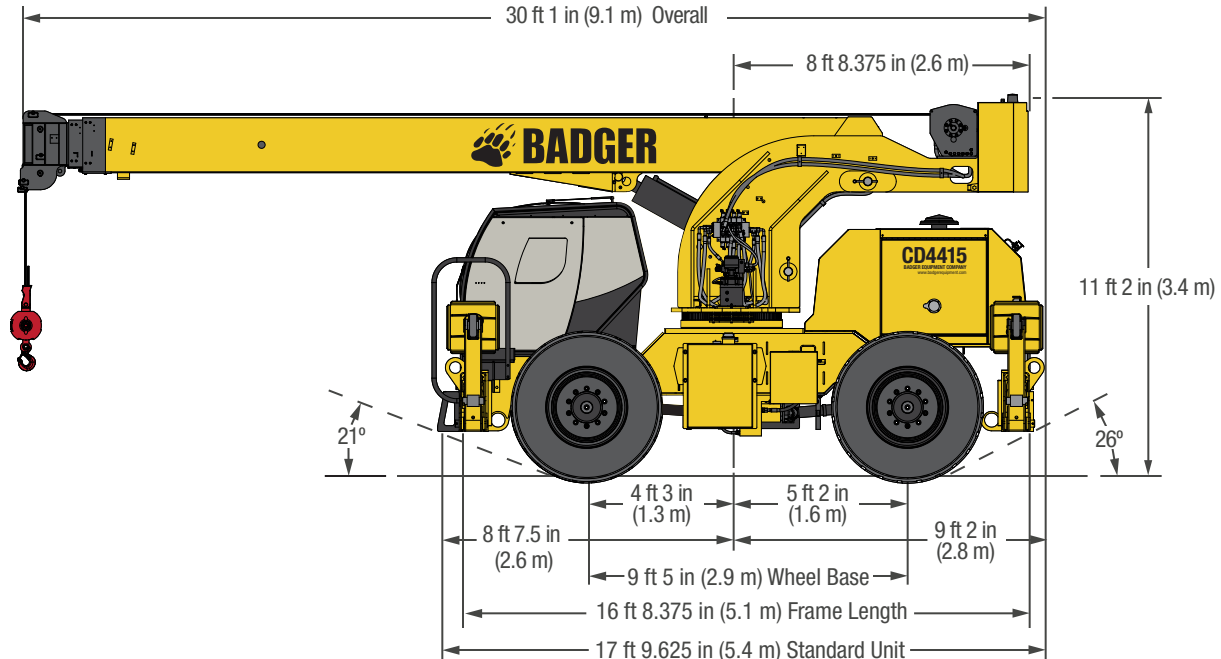

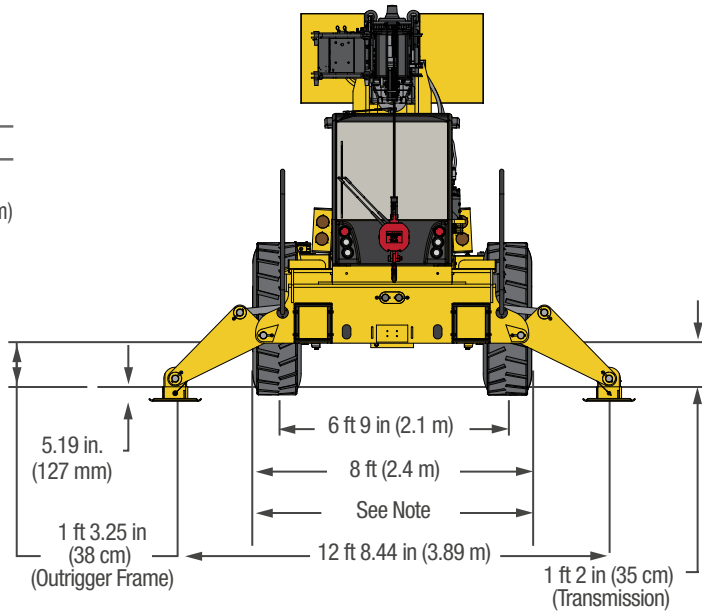

NOTE:

Tire Size	14.00 x 24	17 x 25
Track width	6 ft. 9 in. (2.1 m)	6 ft. 9 in. (2.1 m)
Overall width	7 ft. 11.8 in. (2.4 m)	8 ft. 4.9 in. (2.6 m)



CRANE WEIGHTS



	Standard (Without hook block)	41,800 lb. (18,960 kg)	17,480 lb. (7,930 kg)	24,324 lb. (11,033 kg)
	24 ft (7.3 m) to 62 ft (18.9 m) swing on jib stowed	+609 lb. (+276 kg)	+86 lb. (+39kg)	+523 lb. (+237 kg)
	15T (13.6 mT) 2 sheave hook block	+456 lb. (+207 kg)	+1,249 lb. (+566 kg)	-793 lb. (-360 kg)
	7T (6.35 mT) hook & ball	+180 lb. (82 kg)	+493 lb. (+224 kg)	-313 lb. (-142 kg)

Note: Values are subject to 2% variation

PRELIMINARY RANGE DIAGRAM

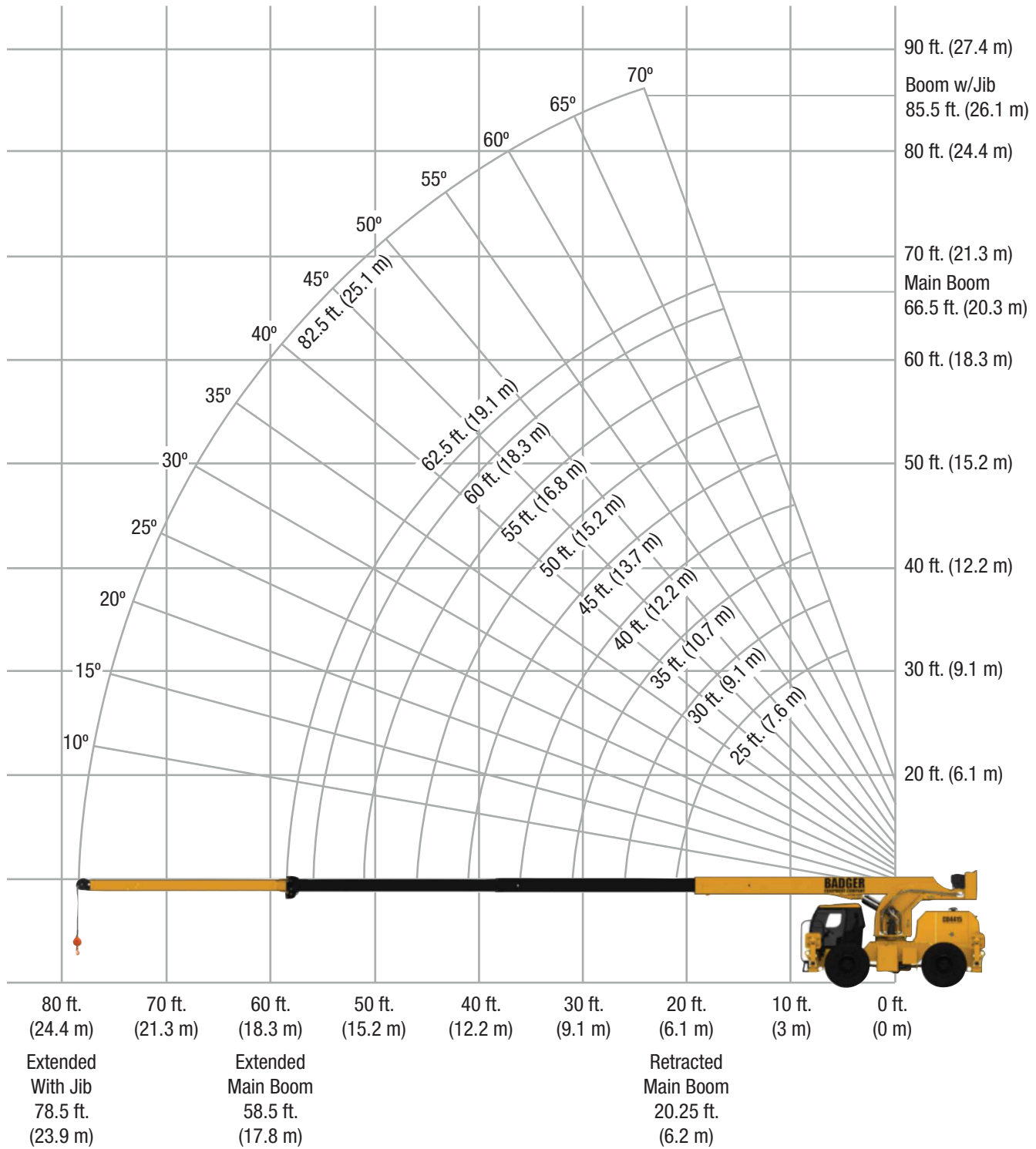

AREA OF OPERATION

ON OUTRIGGERS

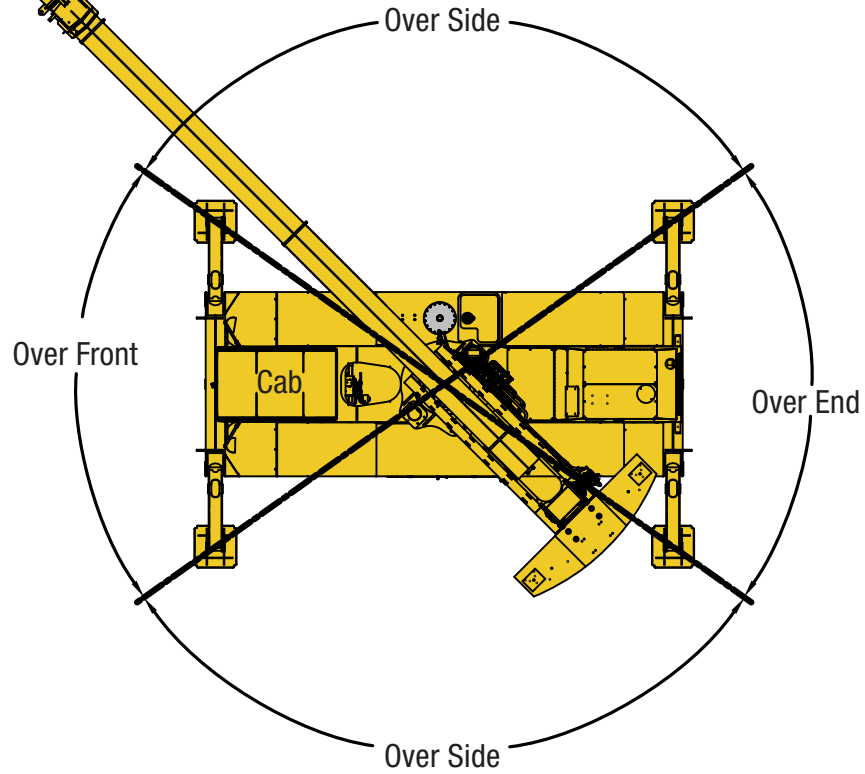

ON TIRES

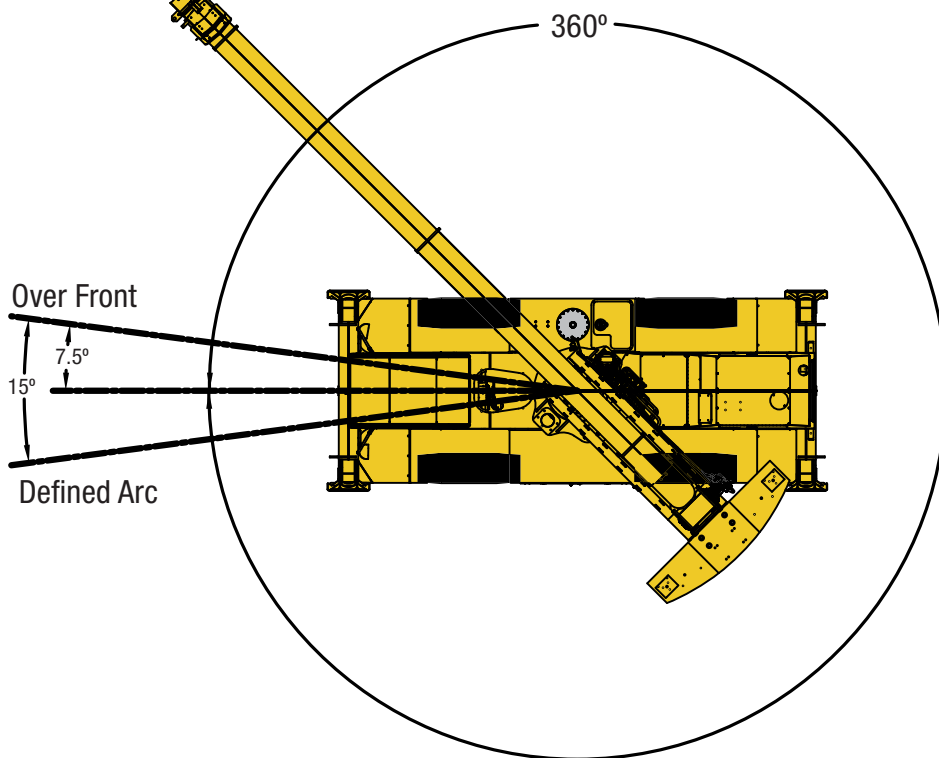

PRELIMINARY LOAD CHART: Main Boom - On Outriggers

Lifting Capacities 3 Section Boom 24 ft. (7.3 m) - 62 ft. (18.9 m)  7,500 lb.  12 ft. 8.4 in. (100%)  360° Standard ASME B30.5

Boom Length	24 ft. Boom			30 ft. Boom			38 ft. Boom			46 ft. Boom			54 ft. Boom			62 ft. Boom		
	Boom Angle (Deg)	Over Front (lbs.)	360° (lbs.)	Boom Angle (Deg)	Over Front (lbs.)	360° (lbs.)	Boom Angle (Deg)	Over Front (lbs.)	360° (lbs.)	Boom Angle (Deg)	Over Front (lbs.)	360° (lbs.)	Boom Angle (Deg)	Over Front (lbs.)	360° (lbs.)	Boom Angle (Deg)	Over Front (lbs.)	360° (lbs.)
10 ft.	55°	30,000	30,000	62°	30,000	30,000	68°	30,000	30,000									
12 ft.	49°	30,000	30,000	58°	30,000	30,000	65°	28,000	28,000	70°	22,500	22,500						
14 ft.	42°	26,300	26,300	53°	26,400	26,400	62°	25,300	25,300	67°	20,900	20,900						
15 ft.	39°	24,400	24,400	51°	24,600	24,600	60°	24,000	24,000	66°	20,100	20,100	69°	17,000	17,000			
16 ft.	35°	22,800	22,800	48°	23,000	23,000	58°	23,000	23,000	64°	19,600	19,600	68°	16,400	16,400			
18 ft.	25°	20,100	20,100	43°	20,300	20,300	55°	20,400	20,400	61°	18,300	18,300	66°	15,400	15,400			
20 ft.	11°	17,900	17,900	37°	18,100	18,100	51°	18,200	18,200	58°	17,200	17,200	64°	14,600	14,600	67°	12,700	12,700
22 ft.				30°	16,300	16,100	47°	16,500	16,200	56°	16,300	16,300	61°	13,900	13,900	65°	12,000	12,000
24 ft.				21°	14,800	14,000	43°	15,000	14,200	52°	15,000	14,300	59°	13,100	13,100	63°	11,300	11,300
25 ft.				16°	14,200	13,200	40°	14,300	13,400	51°	14,400	13,400	57°	12,800	12,800	62°	10,900	10,900
26 ft.				6°	13,500	12,400	38°	13,700	12,600	49°	13,800	12,700	56°	12,400	12,400	61°	10,600	10,600
28 ft.							33°	12,600	11,300	46°	12,700	11,400	54°	11,700	11,300	59°	10,100	10,100
30 ft.							27°	11,300	10,200	42°	11,400	10,300	51°	11,000	10,200	57°	9,500	9,500
35 ft.										32°	9,100	8,200	44°	9,100	8,200	51°	8,400	8,300
40 ft.										17°	7,400	6,700	35°	7,400	6,700	45°	7,500	6,900
45 ft.													25°	6,200	5,600	38°	6,400	5,800
50 ft.													4°	5,300	4,800	30°	5,400	4,900
55 ft.																19°	4,700	4,300

Boom Angle	360° (lbs.)
70°	6,500
60°	4,800
50°	3,900
40°	3,300
30°	2,900
20°	2,700
10°	2,600

Notes:

- Deduct 400 lbs. for stowed jib
- Deduct 1,000 lbs. for erect jib
- Loads above heavy line are based on structural rating
- Loads below heavy line are based on tipping rating
- All "On Outrigger" tipping loads are based on 85% tipping
- Boom angles are undeflected boom angles
- 9/16" - 6x 19 class - 6 x 25 FW, PRF, RRL, XIP, IWRC Wire Rope
- These load ratings are for lift service only
- Weight of hook blocks and slings is part of the load, and is to be deducted from the capacity ratings. Consult operation manual for further details.

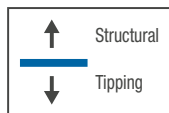

PRELIMINARY LOAD CHART: Main Boom - On Tires

Lifting Capacities 3 Section Boom 24 ft. (7.3 m) - 62 ft. (18.9 m)

7,500 lb.



On tires
17.5 x 25-20 PR

360°

Standard ASME B30.5

Boom Angle (Deg)	24 ft. Boom			30 ft. Boom			38 ft. Boom			46 ft. Boom			54 ft. Boom			62 ft. Boom		
	Boom Angle (Deg)	Over Front (lbs.)	360° (lbs.)	Boom Angle (Deg)	Over Front (lbs.)	360° (lbs.)	Boom Angle (Deg)	Over Front (lbs.)	360° (lbs.)	Boom Angle (Deg)	Over Front (lbs.)	360° (lbs.)	Boom Angle (Deg)	Over Front (lbs.)	360° (lbs.)	Boom Angle (Deg)	Over Front (lbs.)	360° (lbs.)
10 ft.	55°	24,500	19,500	62°	24,700	19,660	68°	24,800	19,800									
12 ft.	49°	17,800	14,600	58°	18,000	14,800	65°	18,100	14,900									
14 ft.	42°	13,900	11,600	53°	14,000	11,700	62°	14,100	11,900									
15 ft.	39°	12,500	10,500	51°	12,600	10,600	60°	12,700	10,700									
16 ft.	35°	11,300	9,600	48°	11,400	9,700	58°	11,500	9,800									
18 ft.	25°	9,400	8,000	43°	9,600	8,200	55°	9,700	8,300									
20 ft.	11°	8,000	6,900	37°	8,200	7,000	51°	8,300	7,100	58°	8,300	7,200						
22 ft.				30°	7,100	6,100	47°	7,200	6,200	56°	7,300	6,300						
24 ft.				21°	6,200	5,400	43°	6,400	5,500	52°	6,400	5,600						
25 ft.				16°	5,900	5,100	40°	6,000	5,200	51°	6,000	5,200						
26 ft.				6°	5,500	4,800	38°	5,700	4,900	49°	5,700	5,000						
28 ft.							33°	5,100	4,400	46°	5,100	4,500						
30 ft.							27°	4,600	4,000	42°	4,600	4,000						
35 ft.										32°	3,700	3,200	44°	3,700	3,200			
40 ft.										17°	3,000	2,600	35°	3,000	2,600			
45 ft.													25°	2,500	2,100	38	2,600	2,200
50 ft.													4°	2,000	1,700	30°	2,100	1,800
55 ft.																19°	1,800	1,600
										60°	Max Angle		50°	Max Angle		45°	Max Angle	

Notes:

- Deduct 400 lbs. for stowed jib
- Deduct 1,000 lbs. for erect jib
- 17.5 x 25.20 ply tires, 90 psi recommended tire pressure
- Loads above heavy line are based on structural rating
- Loads below heavy line are based on tipping rating
- Lifting with jib on tires is not permitted
- Transport of erect jib is allowed with boom fully retracted, 5mph max
- Rotation of erect jib is allowed with boom fully retracted, creep only
- All "On Tires" tipping loads are based on 75% tipping
- Boom angles are undeflected boom angles
- 9/16" - 6 x 19 class - 6 x 25 FW, PRF, RRL, XIP, IWRC Wire Rope

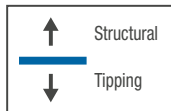

- These load ratings are for lift service only.
- Weight of hook blocks and slings is part of the load, and is to be deducted from the capacity ratings. Consult operation manual for further details.
- Data published herein is intended as a guide only and shall not be construed to warrant applicability for lifting purposes.
- Crane operation is subject to the load charts or computer and operation manual both supplied with the crane.
- Pick & Carry permissible only with boom and load centered over front.

TECHNICAL DESCRIPTION

Boom

Standard Configuration:



3 section hydraulic actuated boom



Full power mechanically synchronized



Min. / Max.

24 ft. / 62.5 ft. (7.3 m / 19 m)



Boom elevation angle range (min. / max.)

0° / 70°

Optional Configuration:



One section jib

20 ft. (6 m)

Offset

0° Fixed

Maximum tip height

85.5 ft. (20.1 m)

Hoist, Rope and Hook

Standard Configuration:



Grooved drum storage capacity

403 ft. (123 m)



	Single Speed (Standard)	Two Speed (Optional)
Without load in 5th layer (low range / high range)	242 fpm (1.23 mps)	297 fpm (1.78 mps)
Without load in 1st layer (low range / high range)	169 fpm (.85 mps)	207 fpm (1.05 mps) / 229 fpm (1.16 mps)



6 x 19 IWRC XIPS, right regular lay, preformed



0.56 in. (14.3 mm)



390 ft. (119 m)



	Single Speed (Standard)	Two Speed (Optional)	
Max. line pull: 1st layer low-range	10,750 lb. (4,886 kg)	Low Speed	11,350 lb. (5,160 kg)
Max. line pull permissible	7,500 lb. (3,400 kg)	High Speed	7,140 lb. (3,238 kg)

Optional Configuration:



7T Hook and Ball

180 lb. (82 kg)

Low Profile

456 lb. (207 kg)

2 Sheaves

456 lb. (207 kg)

Superstructure

Standard Configuration:



Non stop
Maximum rotation speed without load

360°
4.5 rpm



Hydraulic motor
Planetary reducer
Spring applied hydraulic released brakes



360° house lock

Manually applied

Cab, Controls, Operator Aids and Load Limiter/Indicator

Standard Configuration:



Rubber floor mat
Tinted safety glass
Six way adjustable seat

Heater/Defroster
Window wiper with washer and top window
Two lockable doors with sliding windows

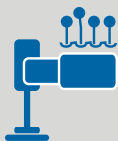

Armrest mounted dual axis electro-proportional joysticks
Steering wheel column with gear selector on the right and directional light selector on the left
Dashboard mounted switches for outrigger operation



Graphic interface for load indicator

Optional Configuration:



Air conditioner
LED work lights
LED strobe light
Perimeter lights

Rearview camera
Front windshield guard
Falling Object Protection System (F.O.P.S.)



Graphic interface for load indicator with Control Lever cut-out function

Carrier, Engine, Drive-line and Hydraulic System

Standard Configuration:



Hydraulic, independent extension:

Outrigger pad size

16 in. x 16 in. (406 mm x 406 mm)

Area of outrigger pads

256 in.² (1,652 cm²)



Cummins® QSB4.5 Tier 3, 4 cylinders

Rated power

160 hp (119 kW) @ 2,500 rpm

Maximum gross torque

460 ft.-lb. (624 Nm) @ 1,500 rpm

Intake

Turbocharger with intercooler

Fuel type

Diesel

Fuel tank capacity

50 gal. (189 L)

Optional Configuration:



Cat® C4.4 Tier 3, 4 cylinders

Rated power

139 hp (104 kW) @ 2,200 rpm

Maximum gross torque

408 ft.-lb. (553 Nm) @ 1,400 rpm

Intake

Turbocharger with intercooler

Fuel type

Diesel

Fuel tank capacity

50 gal. (189 L)

Standard Configuration:



6 x 6 powershift transmission with integral torque converter

Limited slip on front axle

4WD (Four-Wheel Drive) with rear axle disconnect

Hydraulic over-hydraulic drum brakes

Rigid mounted front axle

Parking brake on front axle

Dampened rear axle

Hydraulic oil cooler on carrier



Hydraulic power steering

Four wheel steering crab

Front wheel steering

Independent rear wheel steering package

Four wheel steering coordinated

Rear wheel centering light indication



Hydraulic Pump: Axial Piston

69.5 gpm (263 lpm) @ 3,500 psi (241 bar)

Hydraulic oil reservoir capacity

75 gal. (284 L)

Hydraulic oil suction filter

850 microns with magnet

Hydraulic oil return filter

10 microns

Vehicle Performance

Standard Configuration:

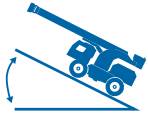

Maximum Gradeability

Up to 80%, based on oil pan restrictions



Maximum Speed (6th gear)

Cummins® Engine

Cat® Engine

26 mph (42 kph)

22 mph (35 kph)

Tires

Standard Configuration:



Wide tread earth mover pattern

17.5 x 25-20 PR

Optional Configuration:



Industrial pattern

14.00 x 24-20 PR

Notes:

Lined area for notes.