

735

Articulated Truck

CATERPILLAR®



Engine

Engine Model	Cat® C15 ACERT™	
Gross Power – SAE J1995	324 kW	435 hp
Net Power – SAE J1349	313 kW	419 hp

Weights

Rated Payload	32.7 tonnes	36 tons
---------------	-------------	---------

Body Capacities

Heaped SAE 2:1	19.7 m ³	25.8 yd ³
----------------	---------------------	----------------------

735 Features

New: Product Link

Satellite technology provides machine data via the internet giving you critical information and enabling Cat dealer World Class services.

New: Improved Visibility

New mirror arrangement and rear view camera.

New: Rear suspension mounts

Caterpillar designed and manufactured rear suspension mounts for improved durability.



Contents

Engine with ACERT™ Technology.....	3
Transmission.....	3
Suspension and Traction Control.....	4
Operator Comfort.....	5
Ease of Operation.....	6
Durability and Reliability.....	7
Serviceability.....	8
Product Link.....	9
Complete Customer Support.....	10
Safety.....	11
735 Articulated Truck Specifications.....	12
735 Standard Equipment.....	17
735 Optional Equipment.....	17
Notes.....	18

Cat 735 with 36 ton (32.7 tonnes) rated payload offers proven reliability and durability, high productivity, superior operator comfort and lower operating costs.

Spacious two-person cab with forward facing trainer/passenger seat and off-road oil/nitrogen front suspension cylinders keep the operator comfortable through out the working day.

True “on-the-go” differential locks with simple operation improve cycle times and productivity.

Strong durable Cat ACERT engines and electronically controlled transmissions deliver high productivity with low fuel consumption.

Engine with ACERT™ Technology

Innovative technologies optimize performance.



ACERT Technology

The Cat® C15 ACERT™ engine introduces a series of evolutionary, incremental improvements that provide breakthrough engine technology built on systems and components developed by Caterpillar with proven reliability.

Advanced Diesel Engine Management (ADEM) A4 Engine Controller

The ADEM™ A4 electronic control module manages fuel delivery and provides flexible fuel mapping, allowing the engine to respond quickly to varying application needs.

Fuel Delivery

Multiple injection fuel delivery involves a high degree of precision. Precisely shaping the combustion cycle lowers combustion chamber temperatures, generating fewer emissions and optimizing fuel combustion. This translates into more work output for your fuel cost.

Noise Reduction Technologies

Noise reduction has been achieved through design changes to the isolated top cover, oil pan, multiple injection strategy, insulated timing case cover, sculpted crankcase and gear train refinements.

Transmission

Proven Reliability.

Electronic Transmission

The Caterpillar seven-speed electronically controlled transmission features anti-hunt shift strategy for speed continuity, and Individual Clutch Modulation (ICM) to ensure constant shift times.

Controlled Throttle Shifting (CTS)

Significantly reduces power train stress and clutch wear by controlling engine speed, torque converter lock-up and transmission clutch engagements.

Two Reverse Gears

The transmission arrangement provides a second reverse gear for improved performance when operating in longer rear hauling applications.



Suspension and Traction Control

Performance and Productivity.

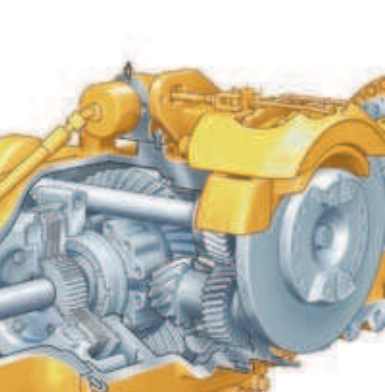

Front Suspension

The three-point front suspension oscillates $\pm 6^\circ$ to provide a smooth ride, allowing the operator to travel at speed over rough terrain and softening impact loads on structures and components. Large bore, low pressure cylinders are purpose designed for tough applications and offer a soft, smooth ride.

Enclosed, Oil-Cooled Brakes

Multi-plate, oil-immersed brakes are fitted to both front and center axles. These brakes provide outstanding stopping capability, while maintaining maximum durability and low wear characteristics.

Rear Suspension

Features a walking beam geometry with Caterpillar designed rear suspension mounts which provide a reliable and stable ride for excellent load retention.

Traction Control

The traction control system is comprised of a wet clutched inter-axle differential and wet clutched cross-axle differentials. All differentials can be engaged and disengaged “on-the-go” for maximum versatility. When used together, the differentials provide 100 percent driveline locking.

Inter-Axle Differential Lock

Locks all three axles in unison and modifies torque distribution for excellent traction in poor underfoot conditions and on grades. It is operated by a switch located at the footrest.

Cross-Axle Differential Locks

Provides full driveline locking – all three axles and all six wheels – for maximum performance in the most adverse conditions. Acts in unison with the inter-axle differential lock when the footswitch is actuated and the dash-mounted switch is selected.



Operator Comfort

High productivity from a comfortable, confident operator.

Ride Comfort

The three-point front suspension with its oscillating axle and low-pressure ride struts, combined with the center-mounted cab, offers unrivaled levels of ride comfort for the operator in all driving conditions. The operator remains comfortable and productive throughout the day.

Spacious Two-Person Cab

The 735 features a large two-person cab, offering comfortable working space for both the operator and trainer or trainee. All 700 Family articulated trucks use the same spacious cab design.

Air Suspension Seat

The air suspension seat enhances operator comfort with a cushioned upper high back, adjustable damping with three settings, ride zone indicator and adjustable lumbar settings. It is fully adjustable to provide the optimal driving position.

Trainer Seat

Full-size trainer seat features a fully padded seat with a backrest and a wide seat belt for a secure and comfortable ride. The trainer seat is positioned next to the operator seat, giving both the operator and trainer a clear view of the instrument panel, controls and the road.

Steering Column

A comfortable driving position is provided by a telescopic and tilt adjustable steering column.

Ease of Operation

Designed for ease of use – allows the operator to focus on production.



Ergonomic Layout

The controls and layout of the cab are designed to make it as easy to operate as your car. Quick, easy to read and simple to operate, the controls and gauges on the 735 allow the operator to concentrate on production.

Dash

The Generation II wrap-around dash puts all controls within easy reach of the operator. Featuring LED illuminated rocker switches, large LCD display and a rear wash wipe rocker switch. It provides an automotive feel with the industrial strength you would expect from Caterpillar.

Viewing Area

The low sloping hood and placement of the cooling package behind the cab give the operator excellent all-around visibility. The large glass area and central operator position also provide excellent visibility.

Wipers

The wet arm wiper system cleans more glass area and is bottom-mounted to keep it out of the operator's line of sight. Windows are tinted to reduce glare.

Differential Lock Controls

The inter-axle differential lock can be engaged/disengaged "on-the-go" by using a raised switch incorporated into the drivers foot rest, for ease of operation. For 100% lock up, all three cross-axle differential locks act in unison with the inter-axle differential lock when the foot switch is activated and a dash mounted switch is selected. Disengaging the foot switch opens all differential locks immediately.

Transmission and Hoist Levers

The hoist lever provides easy, comfortable operation. The transmission lever offers excellent comfort, and control for top gear limit, transmission hold and neutral lock.

Suspended Pedals

Easy to operate and reach with plenty of leg and foot room. They also make for easier cleaning of the cab floor by keeping the pedals out of the dirt.

Cat 2S Monitoring System

Provides an improved method of monitoring critical machine functions and alerts the operator to an immediate or impending problem. The system includes four levels of warning.

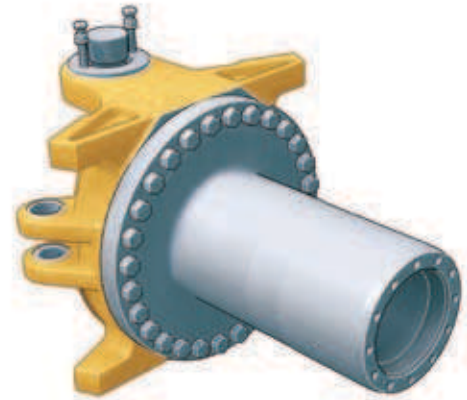
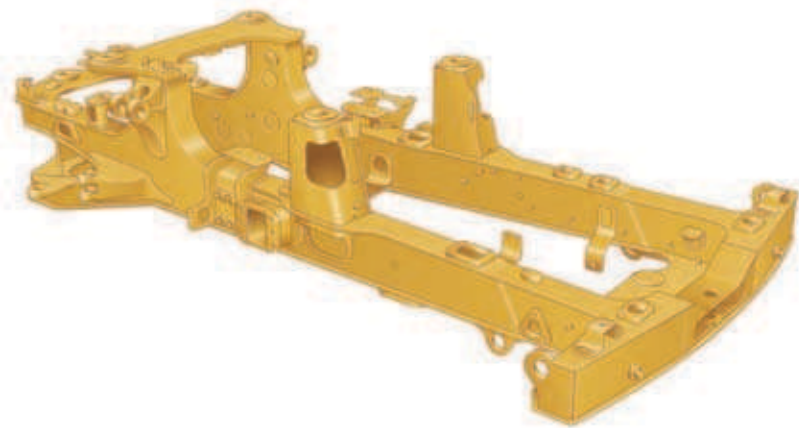

Durability and Reliability

High machine availability maximizes productivity and lowers costs.

Front Frame

The front frame design features a large box section and wide, stiff frame beams to handle torque loads. The divergent frame design decreases stress in the hitch area and optimizes suspension geometry. The frame design makes maximum use of robotic welding for increased durability.

Rear Frame

Twin-box construction minimizes stress concentrations and provides low weight with long service life.

Suspension

The three-point oscillating axle front suspension provides unparalleled ride quality. It also protects the truck from adverse road conditions by absorbing shock loads that would reach the frame.

Articulating/Oscillating Hitch

The articulating hitch provides the truck with steering articulation, and the oscillation ensures all-wheel ground contact in rough terrain.

Hitch Construction

Two-piece construction features a durable cast steel head bolted to a hard-wearing forged steel tube.

Fast Hoist Cycle Times

Fast body raise and lower times mean less time spent in the dump area.

Load-Carrying Capacity

The 735 has a large target area to provide consistently high load-carrying capacity. Its diverging flow design gives clean load ejection, which maximizes production and avoids the waste of material carry-back.

Serviceability

More time on production.



Long Service Intervals

Long engine oil change and hydraulic oil change intervals lower maintenance costs and downtime. Wheel-bearing adjustment is completely eliminated.

Lube Points

Lube points are grouped at the rear of the front frame and the front of the rear frame. Universal joints are lubed for life, eliminating servicing. Autolube is optional.

Service Points

Engine and transmission dipstick and fill caps, air and fuel filters, and the fuel priming pump are all mounted on the left side of the engine under the electrically raised hood. Coolant level indicator and fill cap are outside the cab.

Radiator

The radiator package is located behind the cab, which provides protection from frontal impacts and offers easy access to the inlet and outlet sides of the radiator. The ATTAC radiator is located at the front of the truck.

Extended Life Coolant

Extends the change interval and improves component life by reducing aluminum corrosion.

Electrical Service Center

Located inside the cab, this service center provides a power port, diagnostic connector and Cat Data Link connector.

Cat Data Link Connector

The Cat Data Link connector provides a plug-in using a laptop computer with Electronic Technician (ET) software.

Service Access

The cab tilts to the side to provide easy access underneath, which simplifies access of the transmission, drive shafts and hydraulic pumps. Machine electrical and hydraulic interfaces are located on the right side of the cab, behind a removable cab body panel for easy access.

Truck Transport

The suspension system eliminates the need to lower the suspension when transporting the truck, reducing maintenance and downtime.

Output Transfer Gear

Provides lubrication of all bearings and clutches using a distributed-pressure lubricated and filtered system.



Product Link

Equipment Manager is a secure and user-friendly application.

Equipment Manager – a better way to manage your fleet

Equipment Manager allows transmitted data to be searched and sorted by alert level, group, equipment identification, make and model. Each new machine comes with Asset Watch. However, you can subscribe to a higher level of service for any machine, at any time, through your Cat dealer. Depending on your information needs, Equipment Manager will:

- Report current equipment parameters (machine hours, location, fuel consumption, etc)
- Track all elements of machine maintenance and keep history
- Predict when a service is needed
- Facilitate maintenance scheduling and parts ordering
- Alert you to potential and immediate issues

Asset Watch

Asset Watch manages your assets – enabling you to find your machine quickly, and to control its movement and work schedule.

Maintenance Watch

Maintenance Watch includes all the features of Asset Watch and will also help you plan, coordinate and track your repairs and maintenance, allowing you to align maintenance with machine usage.

Health Watch

Health Watch includes all the features of Asset Watch and will track machine operational conditions to help address potential issues before they become serious. You can also identify abuse, efficiency and training issues with individual operators.



Complete Customer Support

Cat[®] dealer services help you operate longer with lower costs.

Selection

Make comparisons of the machines you are considering before you buy. Your Cat[®] dealer can help.

Purchase

Consider the resale value, compare productivity and day-to-day operating costs and fuel consumption.

Operation

For the best operating techniques to increase productivity and your profit, turn to your Cat dealer for the latest training literature and trained staff.

Maintenance

Repair option programs guarantee the cost of repairs up front. Diagnostic programs such as S•O•SSM and Technical Analysis help you avoid unscheduled repairs.

Replacement

Repair or rebuild? Your Cat dealer can help you evaluate the costs so you can make the right choice.

Product Support

Your local Cat dealership will be with you every step of the way with its unsurpassed worldwide parts support, trained technicians and customer support agreements.

cat.com

For more complete information on Cat products, dealer services and industry solutions, visit us on the Web at www.cat.com

Safety

Designed with safety as the first priority.

Product Safety

Caterpillar has been and continues to be proactive in developing machines that meet or exceed safety standards. Safety is an integral part of all machines and system designs.

Safety Features

- Cab integral ROPS (Roll Over Protection System) and FOPS (Falling Object Protection System)
- Rear view camera system provides a continuous panoramic rear view or when reverse gear is selected
- The secondary and parking brake functions are spring applied and hydraulic released
- Electro-hydraulic secondary steering system, automatically activates in forward/reverse or when stationary if low pressure is sensed. Can be manually selected for machine recovery purposes
- External engine fuel cut off switch for easy access from outside of the machine
- External electrical system disconnect switch for easy access from outside of the machine
- Slip resistant surfaces – punched steel plate
- 75 mm (3 in) wide seat belts for operator/trainer and passenger
- Wide angled mirrors for excellent rear visibility
- Sweeping hood design for panoramic forward visibility
- Extensive hand rails
- Body raised alarm
- Heated mirrors (optional)
- Xenon flashing beacon (optional)



735 Articulated Truck Specifications

Engine

Engine Model	Cat® C15 ACERT™	
Gross Power – SAE J1995	324 kW	435 hp
Net Power – SAE J1349	313 kW	419 hp
Net Power – ISO 9249	319 kW	424 hp
Net Power – EEC 80/1269	319 kW	424 hp
Bore	137 mm	5.4 in
Stroke	171.5 mm	6.75 in
Displacement	15.2 L	926 in ³

- The power ratings apply at rated speed of 1700 rpm when tested under the conditions for the specified standard.
- The net power advertised is the power available at the flywheel when the engine is equipped with alternator, air cleaner, muffler and fan at minimum speed.
- Net power when the fan is at maximum speed is 304 kW (407 hp) per the SAE reference conditions.
- The 735 meets EPA Tier 3/EU Stage 3a emission specifications for the U.S. and Europe through 2010.

Weights

Rated Payload	32.7 tonnes	36 tons
---------------	-------------	---------

Body Capacities

Heaped SAE 2:1	19.7 m ³	25.8 yd ³
Struck	14.7 m ³	19.2 yd ³
Tailgate Heaped SAE 2:1	20.9 m ³	27.3 yd ³
Tailgate Struck	15.2 m ³	19.9 yd ³

Transmission

Forward 1	8 km/h	5 mph
Forward 2	11 km/h	7 mph
Forward 3	15 km/h	10 mph
Forward 4	21 km/h	13 mph
Forward 5	28 km/h	17 mph
Forward 6	38 km/h	23 mph
Forward 7	51 km/h	32 mph
Reverse 1	8 km/h	5 mph
Reverse 2	11 km/h	7 mph

Sound Levels

Interior Cab	79 dB(A)	
--------------	----------	--

- Operator sound exposure Leq (equivalent sound pressure level) measured according to work cycle procedures specified in ANSI/SAE J1166 OCT 98 is 79 dB(A), for the cab offered by Caterpillar, when properly installed and maintained and tested with doors and windows closed.
- Hearing protection may be needed when operating with an open operator station and cab (when not properly maintained or doors/windows open) for extended periods or in noisy environments.

Operating Weights

Front Axle – Empty	18 997 kg	41,881 lb
Center Axle – Empty	6534 kg	14,406 lb
Rear Axle – Empty	5860 kg	12,919 lb
Total – Empty	31 391 kg	69,206 lb
Front Axle – Rated Load	3364 kg	7,417 lb
Center Axle – Rated Load	14 668 kg	32,337 lb
Rear Axle – Rated Load	14 668 kg	32,337 lb
Total – Rated Load	32 700 kg	72,091 lb
Front Axle – Loaded	22 361 kg	49,298 lb
Center Axle – Loaded	21 202 kg	46,743 lb
Rear Axle – Loaded	20 528 kg	45,256 lb
Total – Loaded	64 091 kg	141,297 lb

Body Plate Thickness

Front	8 mm	0.31 in
Scow	14 mm	0.55 in
Side	12 mm	0.47 in
Base	14 mm	0.55 in

Service Refill Capacities

Fuel Tank	532 L	140.5 gal
Cooling System	80 L	21.1 gal
Hydraulic System	330 L	87.2 gal
Engine Crankcase	40 L	10.6 gal
Transmission	72 L	19 gal
Final Drives/ Differential	230 L	60.8 gal
Output Transfer Gear Box	18 L	4.8 gal

Body Hoist

Raise time	11 Seconds	
Lower time	7 Seconds	

Standards

Brakes	ISO 3450 – 1996
Cab/FOPS	ISO 3449 Level II – 2005
Cab/ROPS	ISO 3471 – 2008
Steering	ISO 5010 – 2007

Dimensions

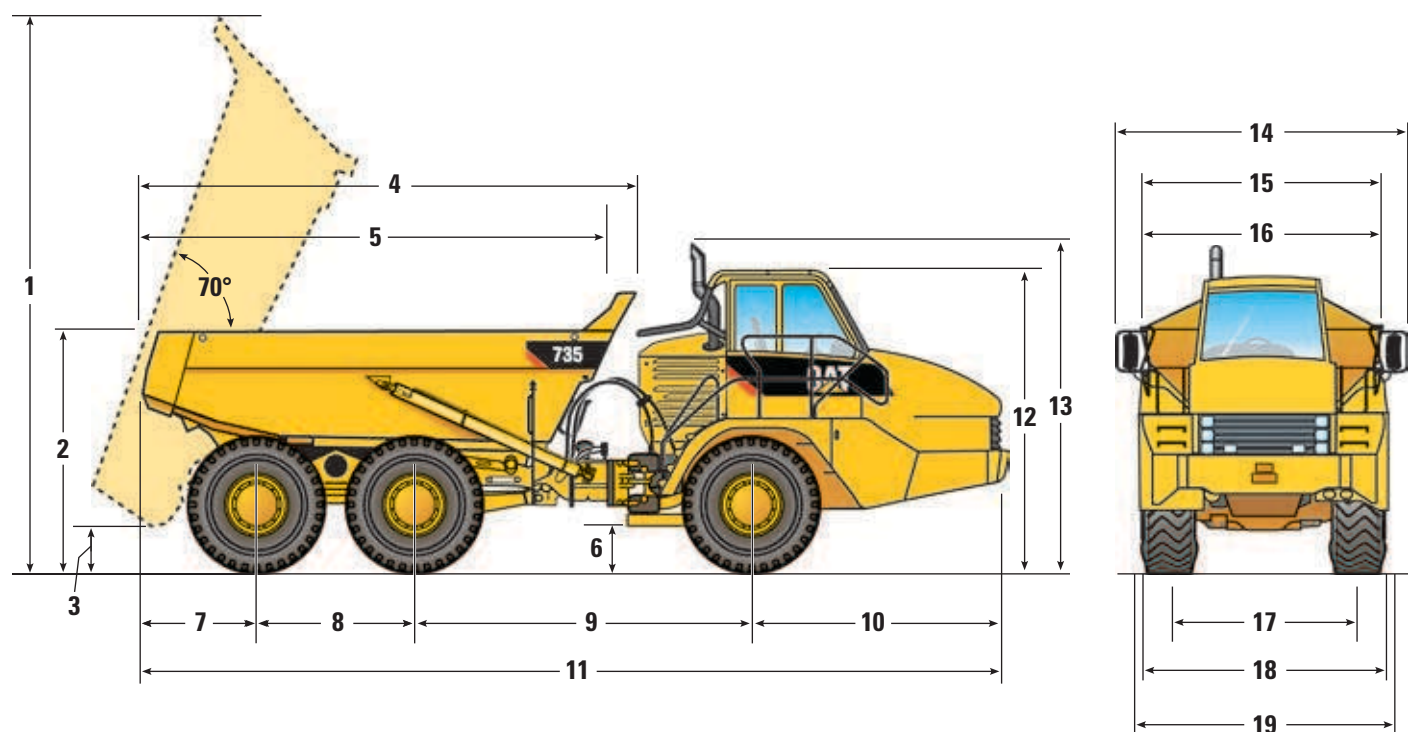

	mm	ft		mm	ft
1	6809	22.3	11	10 889	35.7
2	2982	9.8	12	3703	12.1
3	635	2.0	13**	4006	13.1
4	6088	20.0	14	3823	12.5
5*	5467	17.9	15***	3690	12.1
6	534	1.7	16	3328	10.9
7	1458	4.7	17	2687	8.8
8	1966	6.4	18	3353	11.0
9	4244	13.9	19****	3434	11.3
10	3221	10.5			

*Inside of body.

**Exhaust stack can be removed for transportation.

***If equipped with a scissor tailgate.

****Max-unladen over tire bulge.

735 Articulated Truck Specifications

Turning Circle

Dimensions are for machines equipped with 26.5R25 tires.

Turning dimensions

Steer angle – left/right	45°	
SAE turning radius	8138 mm	320.4 in
Clearance radius	8595 mm	338.4 in
Inside radius	4182 mm	164.7 in
Aisle width	5637 mm	221.9 in

Steering

Lock to Lock

4.6 seconds @ 60 rpm

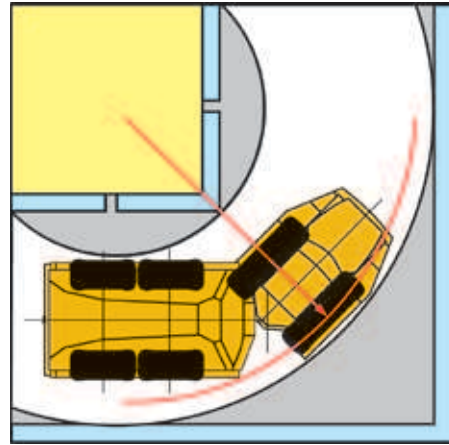

Optimal Loader/Truck Pass Matching

Hydraulic Excavators

	385C	365C	345D
Loader Capacity (Tonnes) – 50 min hr	954-1193	750-1100	665-805
Loader Capacity (Tons) – 50 min hr	1049-1314	825-1210	735-885
Passes	3	4	5

Wheel Loaders

	988H	980H	972H	966H	962H
Loader Capacity (Tonnes) – 50 min hr	565-790	590-650	490-565	400-535	325-400
Loader Capacity (Tons) – 50 min hr	625-870	650-715	540-625	440-590	360-440
Passes	3	3-4	4-5	5	6

An optimum system match gives you a major productivity advantage. The 735 is an excellent match for the Cat 385C, 365C and 345D Hydraulic Excavators; and Cat 962H, 966H, 972H, 980H and 988H Wheel Loaders. This results in increased production and lower system costs per unit of volume moved.

Gradeability/Speed/Rimpull

To determine performance, read from Gross Weight down to % Total Resistance. Total Resistance equals actual % grade plus 1% for each 10 kg/metric ton (20 lb/ton) of Rolling Resistance. From this point, read horizontally to the curve with the highest attainable speed range. Then, go down to Maximum Speed. Usable Rimpull depends on traction available.

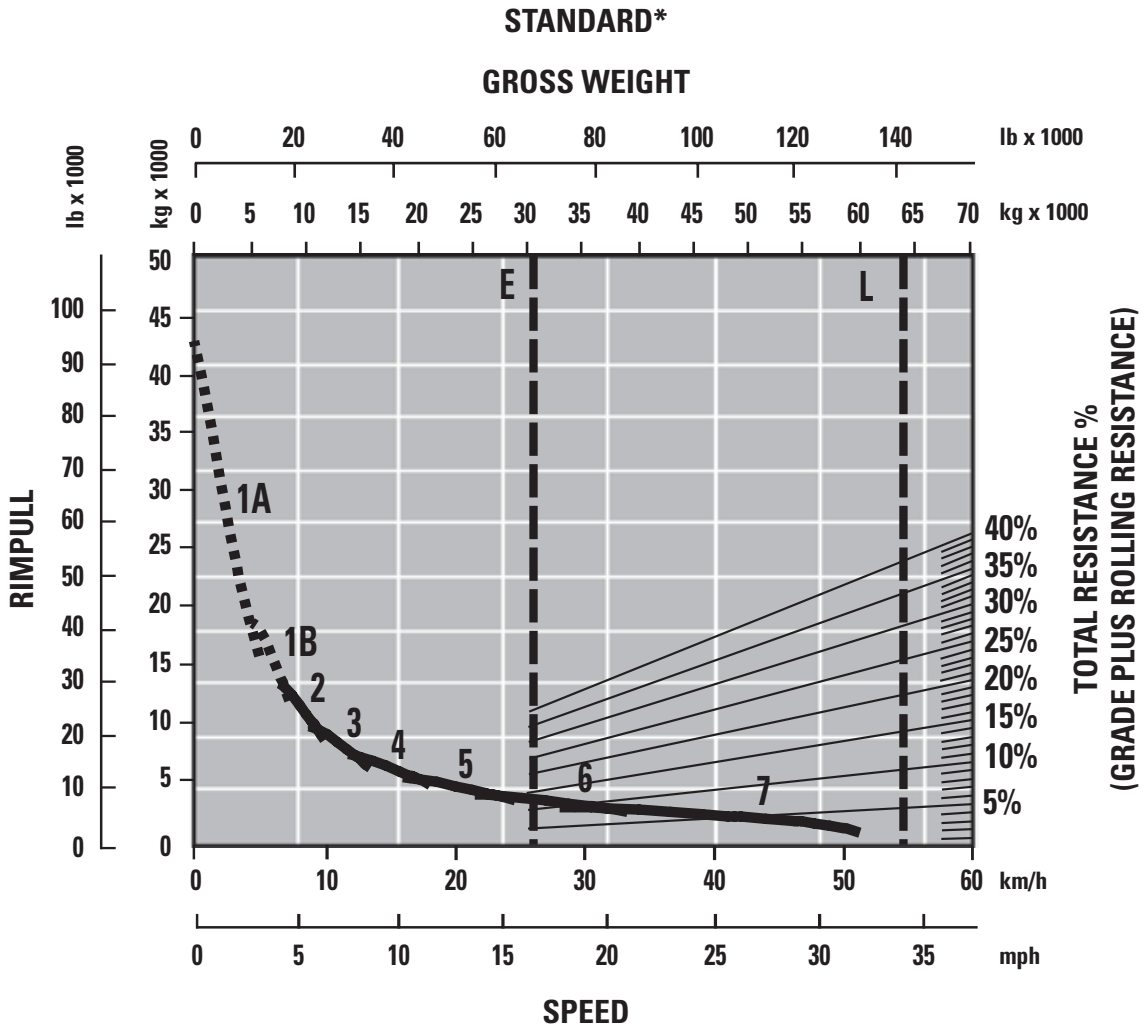

- 1A – 1st Gear (Converter Drive)
- 1B – 1st Gear (Direct Drive)
- 2 – 2nd Gear
- 3 – 3rd Gear
- 4 – 4th Gear
- 5 – 5th Gear
- 6 – 6th Gear
- 7 – 7th Gear

- E – Empty 31 391 kg (69,206 lb)
- L – Loaded 64 090 kg (141,297 lb)
- * at sea level

735 Articulated Truck Specifications

Retarding Performance

To determine performance, read from Gross Weight down to % Effective Grade. Effective Grade equals actual % favorable grade plus 1% for each 10 kg/metric ton (20 lb/ton) of Rolling Resistance. From this point, read horizontally to the curve with the highest attainable speed range. Then, go down to Maximum Speed. Retarding effect on these curves represents full application of the retarder.

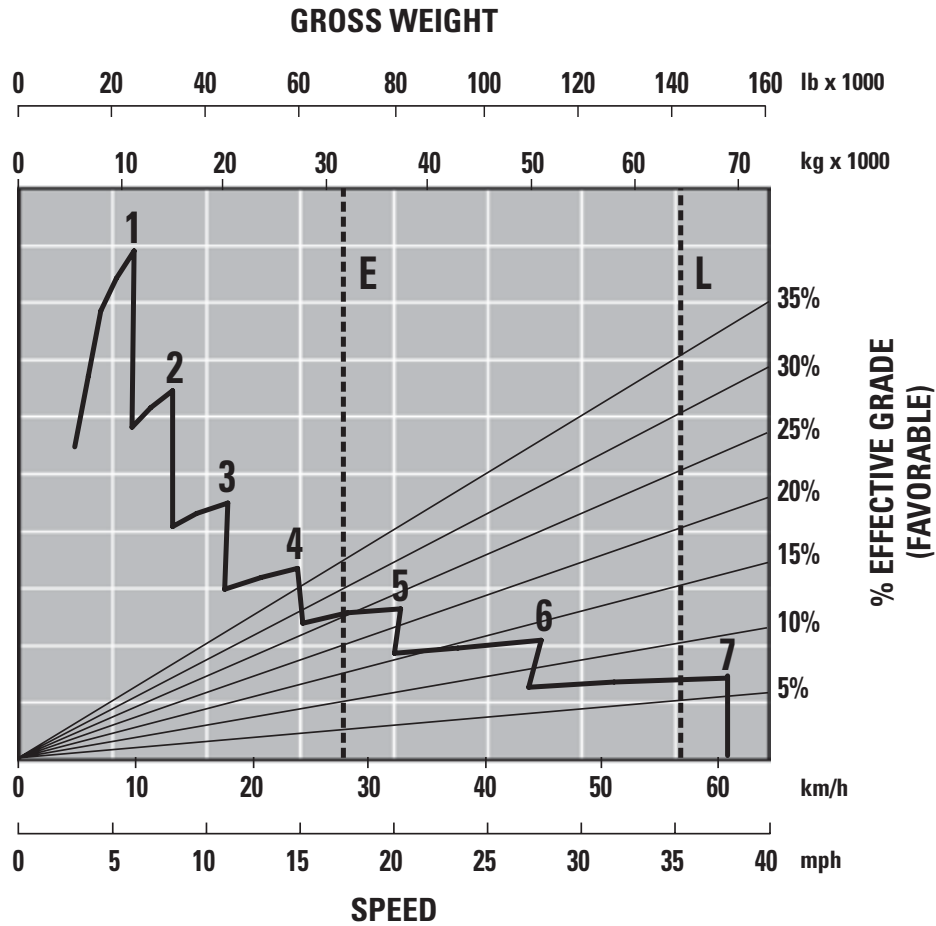

- 1 – 1st Gear
- 2 – 2nd Gear
- 3 – 3rd Gear
- 4 – 4th Gear
- 5 – 5th Gear
- 6 – 6th Gear
- 7 – 7th Gear

- E – Empty 31 391 kg (69,206 lb)
- L – Loaded 64 090 kg (141,297 lb)

735 Standard Equipment

Standard equipment may vary. Consult your Caterpillar dealer for details.

Air conditioning with R134A refrigerant
Air vents, adjustable
Auto shift eight-speed transmission
Back up alarm
Body, adapted for exhaust heat
Cat C15 engine with ACERT Technology
CD/Radio ready
Caterpillar Work Area Vision System (WAVS) rear-view camera
Differentials, standard with clutched cross-axle differential locks for all axles
Electrical system: 24 volt, 5A 24- to 12-volt converter
Electro hydraulic hoist control
Ether starting aid
Glass windows, laminated and tinted, front
Glass windows, toughened and tinted, sides and rear
Guards: rear window radiator, crankcase and axle
Headlights, four
Heater and defroster with four-speed fan
Horn, electric

Lights: cab interior, front, side rear, two reversing/working lights, two stop/tail lights, front and rear direction indicators
Mirrors, main and auxiliary, left and right
Mud flaps, wheel arch and body mounted, with transportation tie backs
Oil-cooled brakes, enclosed
Product Link (US/Canada/Europe/Turkey/Australia/New Zealand)
Retarder, Engine compression brake
ROPS/FOPS cab, with full instrumentation, including:
– Instrument cluster display module.
– Indicator lamps: left turn, secondary steering, primary steering loss, front and rear brake temp (735/740 and 740 Ejector only), brake oil pressure, action lamp, transmission fault, park brake, charging system status, differential lock, body not in float, right turn, high beam, transmission hold, machine filter warning, retarder, retarder up shift warning
– Gauges: engine oil pressure, engine coolant temperature, torque converter oil temperature, fuel level, and fuel tank level gauge

– Meters: service hour meter, speedometer, tachometer
Seat, fully adjustable, air suspension
Seat, padded companion/trainer
Secondary steering – electronic
S•O•SSM sampling valves
Spill guard, front, integral part of fabricated body
Starting receptacle, electric, remote
Storage – two cup holders, flask receptacle, under seat storage, door pocket, behind seat storage, coat hook
Sun visor
Three-axle, six wheel drive
Tilt and telescopic steering wheel
Tires, 26.5R25, radial
Tow pins, front and rear
Two Seat Belts, operator's retractable
Vandalism protection: lockable caps for fuel tank and hydraulic oil tank
Windows, opening side, tinted
Windshield wiper and washer, two speed, intermittent (front)
Windshield wiper and washer, two speed (rear)

735 Optional Equipment

Optional equipment may vary. Consult your Caterpillar dealer for details.

Autolube installation for automatic greasing of bearings
Bath oil, pre-cleaner
Body liners
CD/Radio, heavy duty
Cold Weather Coolant –51° C (–59.8° F)

Cold weather start kit
Cycle counter/operator monitoring kit
Engine Block Heater
Exhaust heated body
Fast fuel fill
Flashing Xenon Beacon

Fuel Additive – anti-waxing
Heated rear-view mirrors
Product Link, Radio and Worldwide (where available)
Tailgate:
– Scissor-type

735 Articulated Truck

For more complete information on Cat products, dealer services, and industry solutions, visit us on the web at www.cat.com

© 2009 Caterpillar Inc.
All rights reserved

Materials and specifications are subject to change without notice. Featured machines in photos may include additional equipment. See your Caterpillar dealer for available options.

CAT, CATERPILLAR, SAFETY.CAT.COM, their respective logos, "Caterpillar Yellow" and the POWER EDGE trade dress, as well as corporate and product identity used herein, are trademarks of Caterpillar and may not be used without permission.

AEHQ6049 (06-2009)

Replaces AEHQ5648-03