

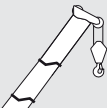









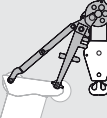







AC 250-5



















All Terrain Crane

300UST CAPACITY CLASS

		Page:
Dimensions.....		4
Specifications.....		6
Equipment.....		7
Counterweight.....		8
	HA Main boom	9
	HAV Folding swing-away jib	22
	HAV-VA Variable extension with swing-away jib	26
	MS Runner	30
Technical description.....		36

	Counterweight
	Lifting capacities on outriggers - 360°
	Radius
	Main boom
	Folding swing-away jib
	Runner
	Max. axle loads
	Mechanism
	Tires
	Hook block
	Hoist
	Dolly
	Travel speed
	Gradeability – road
	Gradeability – off road
	Slewing

	Boom telescoping
	Boom elevation
	Working speeds
	Max. line pull
	Rope diameter
	Rope length
	Hook block (capacity-sheaves-rope diameter)
	Number of lines
	Possible load of hook block
	Weight of hook block
	Distance head sheave axle – hook ground
	Number of sheaves in boom head
	Supporting force
	Length of stroke (support cylinders)
	Payload incl. rear storage box
	Additional parts for hydraulic system

DIMENSIONS

AC 250-5

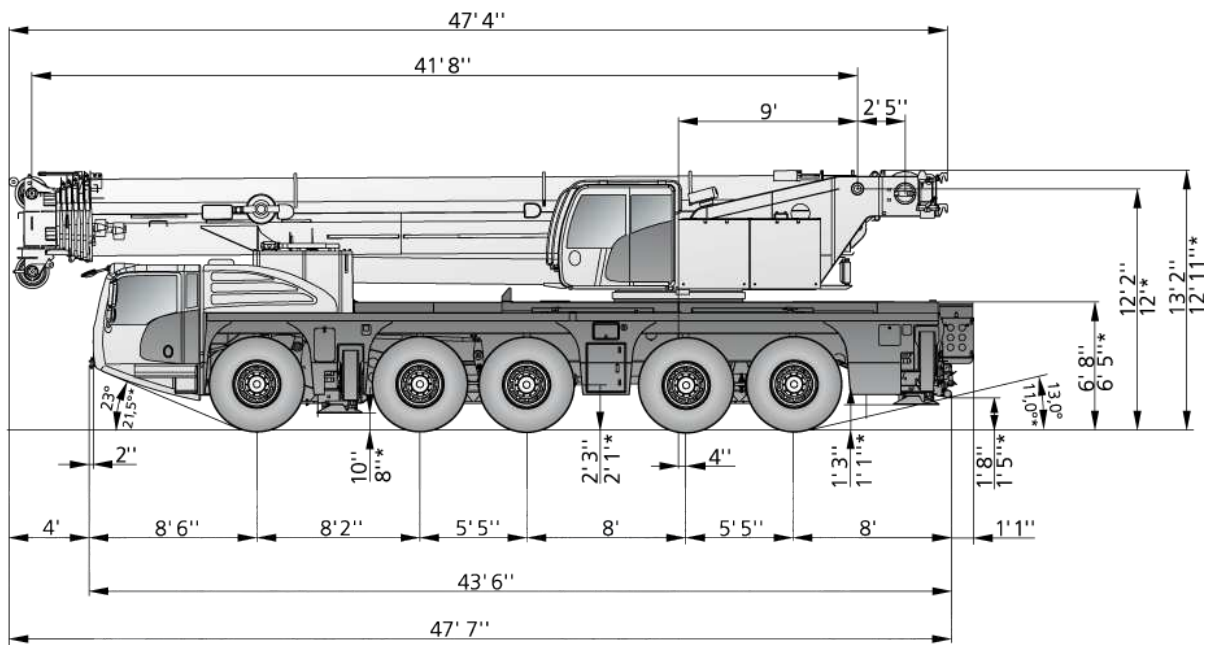



⊙ 445/95 R25 / 525/80 R25

* ⊙ 385/95 R25

DIMENSIONS

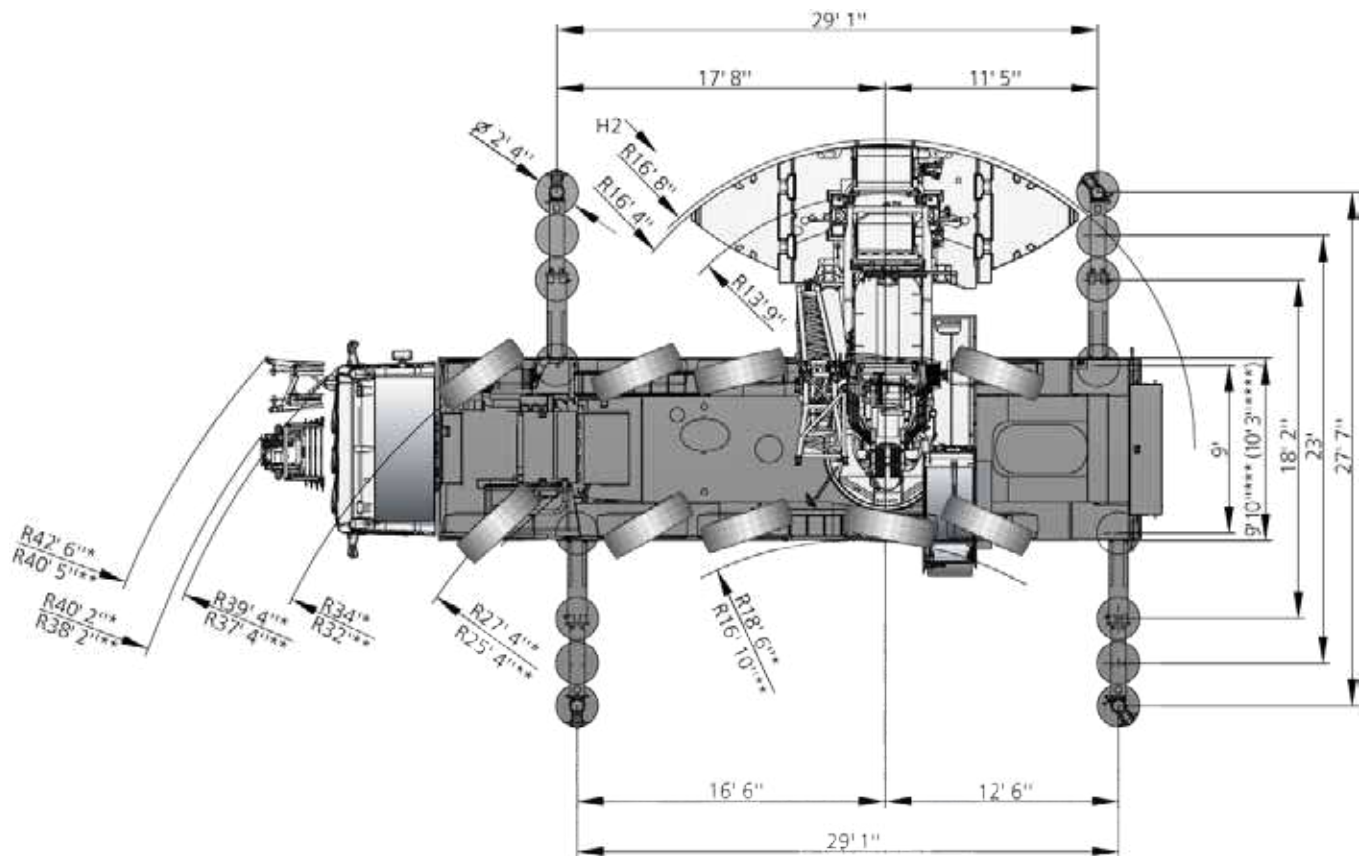









AC 250-5









- * steering mode 2
- ** steering mode 3
- ***  385/95 R25 / 445/95 R25
- ****  525/80 R25
- see page 6



SPECIFICATIONS

AC 250-5



											
	Total										
< 20,000 lb				On request!							X
18,700 lb	83,800 lb	10x6x10	385/95R25	–	–	–	–	–	–	–	
26,500 lb	132,300 lb	10x8x10	445/95R25	229.7 ft	32-1-21 Vario	–	–	–	660 lb	–	
26,500 lb	132,300 lb	10x8x10	445/95R25	229.7 ft	–	–	–	X	1210 lb	–	
29,100 lb	138,900 lb	10x8x10	445/95R25	229.7 ft	32-1-21	–	68.9 ft	–	1760 lb	–	
36,400 lb	180,800 lb	10x8x10	445/95R25	229.7 ft	80-3-21	41,200 lb	68.9 ft	–	1760 lb	–	









	1 Highway > 28 mph		4* Off-wall
	2 City < 28 mph		5* Crab steer mode
	3* Minimum turning radius < 3.1 mph		6* All wheel steering







*must be activated

		
209,500 lb	231,500 lb	52.8 mph ¹⁾
16.9 in	23 in	

¹⁾ Depending on tire type, size and country specific legislation

	385 / 95 R25 14.00 R25	445 / 95 R25 16.00 R25	525 / 80 R25 20.50 R25
	47 %	40 %	40 %
	64 %	53 %	53 %

				
1	394 ft/min	22,076 kN	0.83 in	1083 ft
2	394 ft/min	22,076 kN	0.83 in	1083 ft
	1,40 min ⁻¹			
	ca. 527 s (41.7-229.7 ft)			
	ca. 49 s (-1,4° - 82°)			

					
1	21,800	12-0-21	4	770 lb	6.6 ft
2	43,400	32-1-21	4	1320 lb	8.9 ft
3	64,800	32-1-21	4	1320 lb	8.9 ft
4	86,200	80-3-21	4	1870 lb	9.8 ft
5	107,200	80-3-21	4	1870 lb	9.8 ft
6	127,900	80-3-21	4	1870 lb	9.8 ft
7	148,400	80-3-21	4	1870 lb	9.8 ft
8	168,900	125-5-21	4	2480 lb	9.8 ft
9	189,000	125-5-21	4 + 1	2480 lb	9.8 ft
10	209,000	125-5-21	4 + 1	2480 lb	9.8 ft
12	248,300	160-7-21	4 + 1 + S1	3310 lb	9.8 ft
14	286,600	160-7-21	4 + 1 + S1	3310 lb	9.8 ft

HAV / HAV-VA

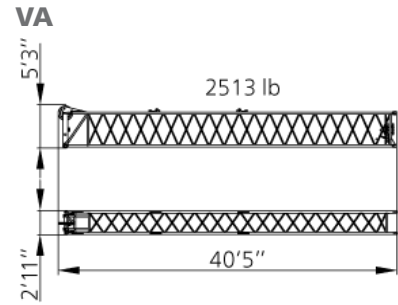
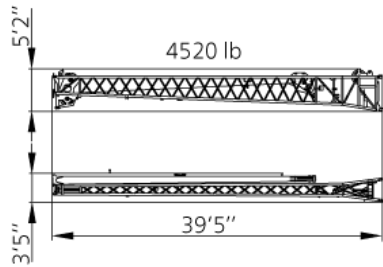

HAV-VA 108.3 ft

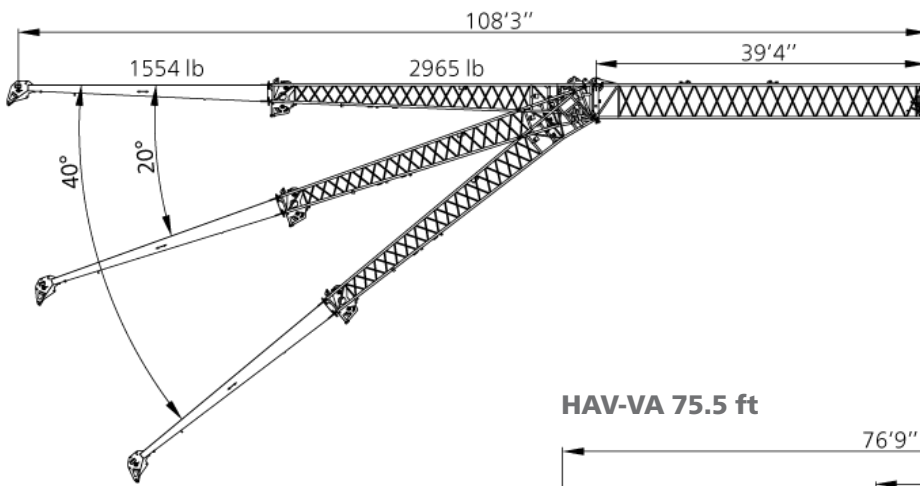

HAV-VA 75.5 ft

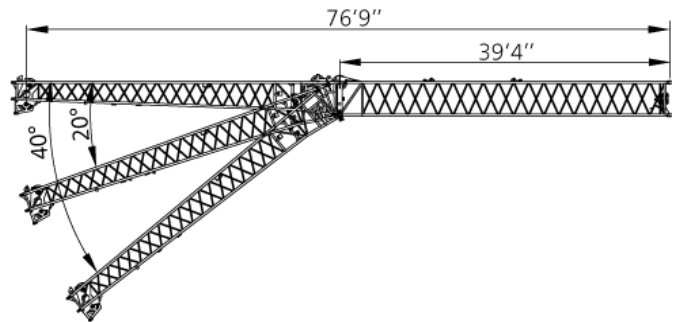

HAV 68.9 ft

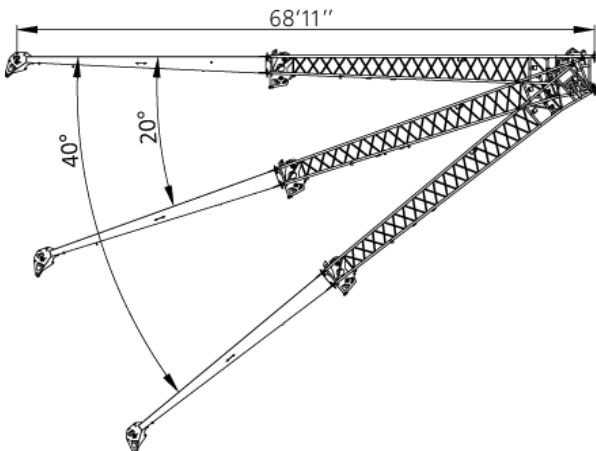

HAV 36.1 ft

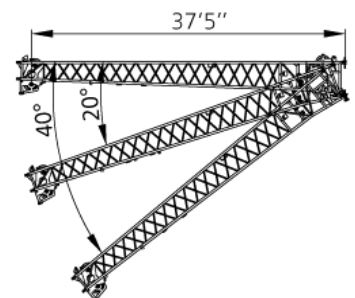

COUNTERWEIGHT

AC 250-5

Parts

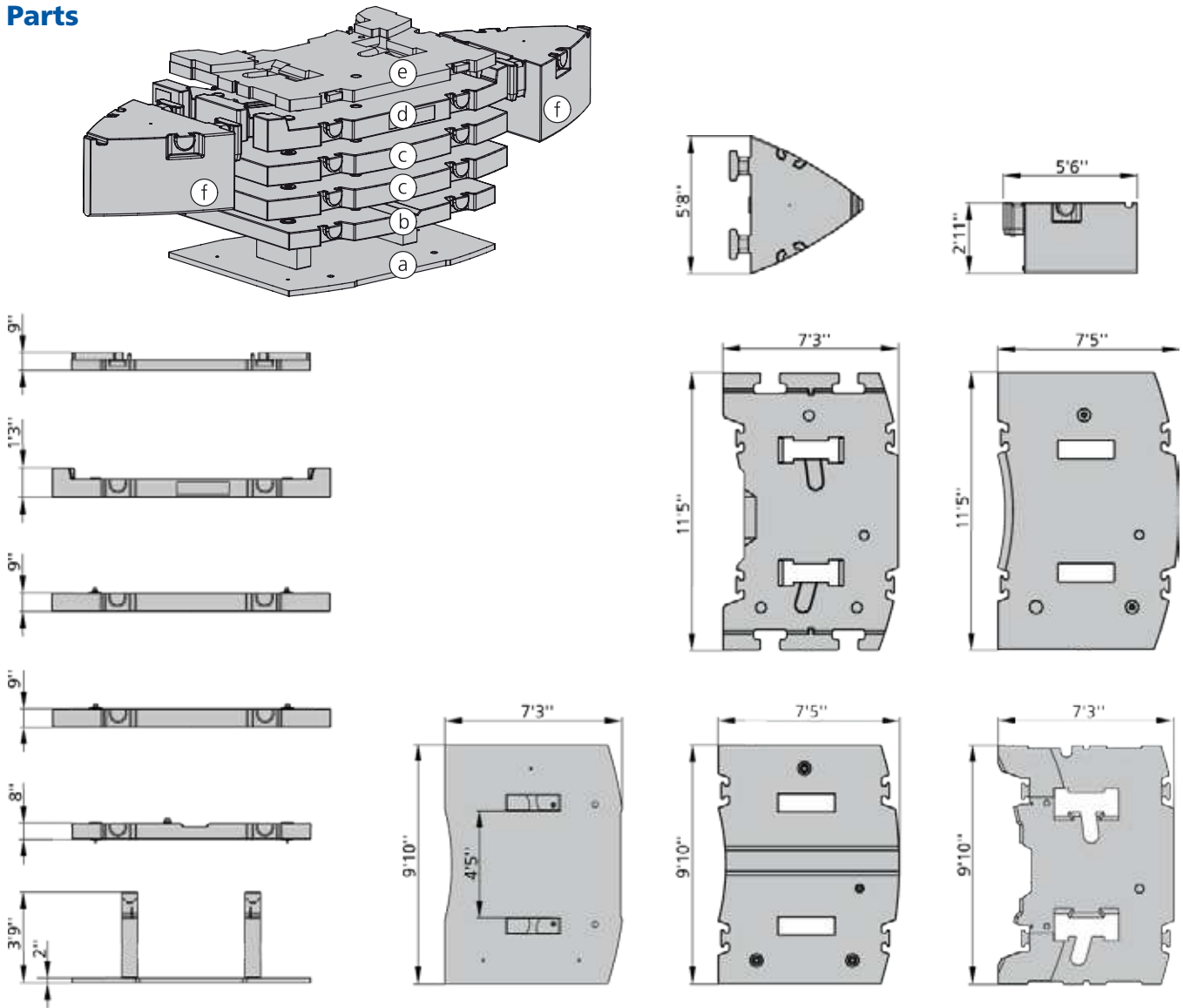

Configurations

	Ⓐ 11,250 lb	Ⓑ 17,640 lb	Ⓒ 24,700 lb	Ⓓ 24,700 lb	Ⓔ 23,150 lb	Ⓕ 12,350 lb	Ⓖ 20,500 lb	Ⓗ 20,500 lb
0 lb								
11,250 lb	X							
28,900 lb	X	X						
41,200 lb	X	X				X		
53,600 lb	X	X	X					
65,900 lb	X	X	X			X		
78,300 lb	X	X	X	X				
90,600 lb	X	X	X	X		X		
101,400 lb	X	X	X	X	X			
113,800 lb	X	X	X	X	X	X		
154,800 lb	X	X	X	X	X	X	X	X

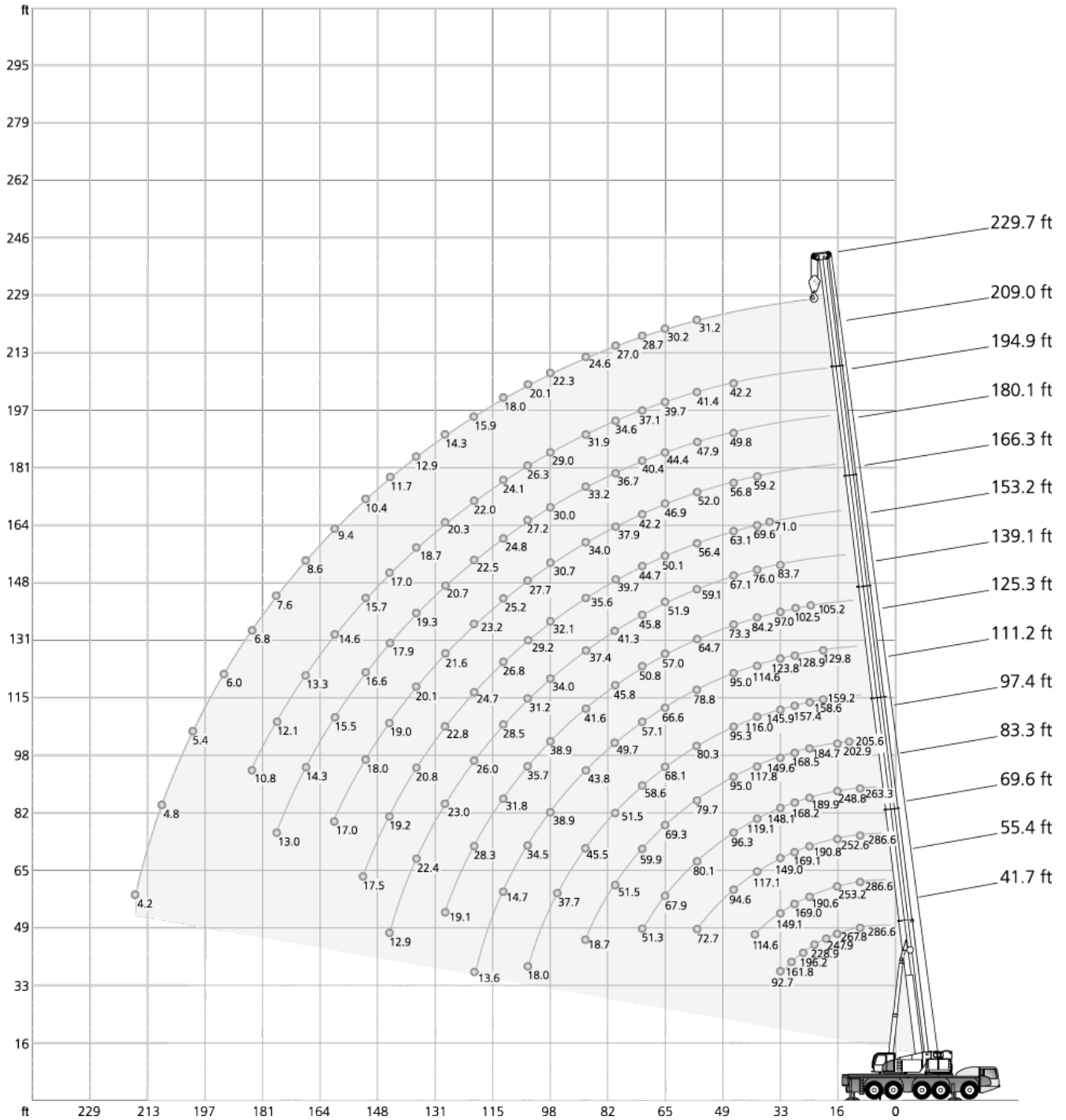
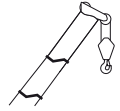

☰ 154,800 lb		📏 27.60 ft x 29.10 ft														360°		85%	
📐		41.7ft* 41.7ft 55.4ft 69.6ft 83.3ft 97.4ft 111.2ft 125.3ft 139.1ft 153.2ft 166.3ft 180.1ft 194.9ft 209.0ft 229.7ft														📐			
ft	1,000 lb																ft		
10	550.0**	-	-	-	-	-	-	-	-	-	-	-	-	-	-	-	-	-	10
10	286.6	286.6	286.6	286.6	263.3	-	-	-	-	-	-	-	-	-	-	-	-	-	10
12	286.6	285.9	286.3	285.6	262.0	-	-	-	-	-	-	-	-	-	-	-	-	-	12
14	283.7	273.8	274.9	273.3	259.5	205.6	-	-	-	-	-	-	-	-	-	-	-	-	14
16	267.8	251.3	253.2	252.6	248.8	202.9	-	-	-	-	-	-	-	-	-	-	-	-	16
18	247.9	233.1	235.0	235.0	232.7	200.2	159.2	-	-	-	-	-	-	-	-	-	-	-	18
20	228.9	216.2	217.8	217.8	216.7	197.0	158.6	129.8	-	-	-	-	-	-	-	-	-	-	20
24	196.2	189.1	190.6	190.8	189.9	184.7	157.4	128.9	105.2	-	-	-	-	-	-	-	-	-	24
28	161.8	160.9	169.0	169.1	168.2	168.5	154.3	126.9	102.5	-	-	-	-	-	-	-	-	-	28
32	92.7	92.7	149.1	149.0	148.1	149.6	145.9	123.8	97.0	83.7	-	-	-	-	-	-	-	-	32
36	-	-	132.5	132.3	131.7	133.0	131.2	119.8	90.5	80.1	71.0	-	-	-	-	-	-	-	36
40	-	-	114.6	117.1	119.1	117.8	116.0	114.6	84.2	76.0	69.6	59.2	-	-	-	-	-	-	40
48	-	-	-	94.6	96.3	95.0	95.3	95.0	73.3	67.1	63.1	56.8	49.8	42.2	-	-	-	-	48
56	-	-	-	72.7	80.1	79.7	80.3	78.8	64.7	59.1	56.4	52.0	47.9	41.4	31.2	-	-	-	56
64	-	-	-	-	67.9	69.3	68.1	66.6	57.0	51.9	50.1	46.9	44.4	39.7	30.2	-	-	-	64
72	-	-	-	-	51.3	59.9	58.6	57.1	50.8	45.8	44.7	42.2	40.4	37.1	28.7	-	-	-	72
80	-	-	-	-	-	51.5	51.5	49.7	45.8	41.3	39.7	37.9	36.7	34.6	27.0	-	-	-	80
88	-	-	-	-	-	18.7	45.5	43.8	41.6	37.4	35.6	34.0	33.2	31.9	24.6	-	-	-	88
96	-	-	-	-	-	-	37.7	38.9	38.9	34.0	32.1	30.7	30.0	29.0	22.3	-	-	-	96
104	-	-	-	-	-	-	18.0	34.5	35.7	31.2	29.2	27.7	27.2	26.3	20.1	-	-	-	104
112	-	-	-	-	-	-	-	14.7	31.8	28.5	26.8	25.2	24.8	24.1	18.0	-	-	-	112
120	-	-	-	-	-	-	-	13.6	28.3	26.0	24.7	23.2	22.5	22.0	15.9	-	-	-	120
128	-	-	-	-	-	-	-	-	19.1	23.0	22.8	21.6	20.7	20.3	14.3	-	-	-	128
136	-	-	-	-	-	-	-	-	13.2	22.4	20.8	20.1	19.3	18.7	12.9	-	-	-	136
144	-	-	-	-	-	-	-	-	-	12.9	19.2	19.0	17.9	17.0	11.7	-	-	-	144
152	-	-	-	-	-	-	-	-	-	-	17.5	18.0	16.6	15.7	10.4	-	-	-	152
160	-	-	-	-	-	-	-	-	-	-	-	17.0	15.5	14.6	9.4	-	-	-	160
168	-	-	-	-	-	-	-	-	-	-	-	-	14.3	13.3	8.6	-	-	-	168
176	-	-	-	-	-	-	-	-	-	-	-	-	13.0	12.1	7.6	-	-	-	176
184	-	-	-	-	-	-	-	-	-	-	-	-	-	10.8	6.8	-	-	-	184
192	-	-	-	-	-	-	-	-	-	-	-	-	-	-	6.0	-	-	-	192
200	-	-	-	-	-	-	-	-	-	-	-	-	-	-	5.4	-	-	-	200
208	-	-	-	-	-	-	-	-	-	-	-	-	-	-	4.8	-	-	-	208
216	-	-	-	-	-	-	-	-	-	-	-	-	-	-	4.2	-	-	-	216
1)	46.7	46.7	34.2	26.2	20.7	16.5	13.0	10.1	7.3	5.1	3.7	-	-	-	-	-	-	-	1)

1) Capacities with horizontal boom
 * over rear
 ** Capacity class

113,800 lb		27.60 ft x 29.10 ft						360° / Max.*						85%	
ft	360° 41.7ft	Max. 41.7ft	360° 55.4ft	Max. 55.4ft	360° 69.6ft	Max. 69.6ft	360° 83.3ft	Max. 83.3ft	360° 97.4ft	Max. 97.4ft	360° 111.2ft	Max. 111.2ft	360° 125.3ft	Max. 125.3ft	ft
1,000 lb															
10	286.6	286.6	286.6	286.6	286.6	286.6	263.3	263.3	-	-	-	-	-	-	10
12	284.9	285.9	285.6	286.3	284.9	285.6	262.0	262.0	-	-	-	-	-	-	12
14	271.1	273.8	272.7	274.9	270.5	273.3	259.5	259.5	205.6	205.6	-	-	-	-	14
16	249.1	251.3	250.2	253.2	250.2	252.7	248.8	248.8	202.9	202.9	-	-	-	-	16
18	230.9	233.1	232.2	235.0	232.2	235.0	231.8	232.7	200.2	200.2	159.2	159.2	-	-	18
20	214.1	216.1	215.6	217.7	215.6	217.6	214.7	216.5	197.0	197.0	158.6	158.6	129.8	129.8	20
24	185.5	185.6	187.1	187.5	187.2	187.3	186.3	186.3	182.9	182.9	157.4	157.4	128.9	128.9	24
28	157.6	157.6	160.0	160.0	160.0	160.0	158.9	158.9	160.6	160.6	152.8	152.8	126.9	126.9	28
32	92.7	92.7	137.7	137.7	137.5	137.5	139.6	139.6	138.2	138.2	136.2	136.2	123.8	123.8	32
36	-	-	120.7	120.7	120.6	120.6	122.6	122.6	121.2	121.2	119.3	119.3	115.7	115.7	36
40	-	-	103.9	103.9	107.8	108.0	107.4	107.4	106.0	106.0	108.0	108.0	106.0	106.0	40
48	-	-	-	-	87.0	87.0	86.6	86.6	87.5	87.5	87.0	87.0	85.3	85.3	48
56	-	-	-	-	68.6	68.6	71.8	71.8	73.3	73.3	72.2	72.2	70.2	70.2	56
64	-	-	-	-	-	-	62.1	62.8	61.2	62.0	59.8	60.9	57.6	59.2	64
72	-	-	-	-	-	-	51.2	51.2	51.1	53.5	49.6	52.2	47.4	50.7	72
80	-	-	-	-	-	-	-	-	43.6	46.8	42.0	45.6	41.8	43.9	80
88	-	-	-	-	-	-	-	-	18.7	18.7	36.2	40.3	37.5	38.5	88
96	-	-	-	-	-	-	-	-	-	-	33.1	35.8	32.9	35.7	96
104	-	-	-	-	-	-	-	-	-	-	18.0	18.0	28.9	33.0	104
112	-	-	-	-	-	-	-	-	-	-	-	-	14.7	14.7	112
120	-	-	-	-	-	-	-	-	-	-	-	-	13.6	13.6	120
1)	46.7	46.7	34.2	34.2	26.2	26.2	20.7	20.7	16.5	16.5	13.0	13.0	10.1	10.1	1)

ft	360° 139.1ft	Max. 139.1ft	360° 153.2ft	Max. 153.2ft	360° 166.3ft	Max. 166.3ft	360° 180.1ft	Max. 180.1ft	360° 194.9ft	Max. 194.9ft	360° 209.0ft	Max. 209.0ft	360° 229.7ft	Max. 229.7ft	ft
1,000 lb															
24	105.2	105.2	-	-	-	-	-	-	-	-	-	-	-	-	24
28	102.5	102.5	-	-	-	-	-	-	-	-	-	-	-	-	28
32	97.0	97.0	83.7	83.7	-	-	-	-	-	-	-	-	-	-	32
36	90.5	90.5	80.1	80.1	71.0	71.0	-	-	-	-	-	-	-	-	36
40	84.2	84.2	76.0	76.0	69.6	69.6	59.2	59.2	-	-	-	-	-	-	40
48	73.3	73.3	67.1	67.1	63.1	63.1	56.8	56.8	49.8	49.8	42.2	42.2	-	-	48
56	64.7	64.7	59.1	59.1	56.4	56.4	52.0	52.0	47.9	47.9	41.4	41.4	31.2	31.2	56
64	56.0	57.0	51.9	51.9	50.1	50.1	46.9	46.9	44.4	44.4	39.7	39.7	30.2	30.2	64
72	48.2	50.0	45.8	45.8	44.7	44.7	42.2	42.2	40.4	40.4	37.1	37.1	28.7	28.7	72
80	41.5	44.5	39.4	41.3	38.7	39.7	37.9	37.9	36.7	36.7	34.6	34.6	27.0	27.0	80
88	35.5	39.7	33.5	37.4	33.9	35.6	33.1	34.0	33.2	33.2	31.9	31.9	24.6	24.6	88
96	31.1	35.2	29.2	33.5	28.9	32.1	29.7	30.7	29.2	30.0	29.0	29.0	22.3	22.3	96
104	27.6	31.3	27.3	29.6	26.0	29.2	26.7	27.7	26.5	27.2	26.0	26.3	20.1	20.1	104
112	24.1	28.1	24.3	26.3	24.1	26.7	24.3	25.2	23.4	24.8	22.5	24.1	18.0	18.0	112
120	22.5	25.2	21.9	24.2	21.6	23.8	21.2	23.2	20.3	22.5	19.4	22.0	15.9	15.9	120
128	15.3	17.8	19.6	22.9	19.8	21.3	19.3	21.6	17.7	20.7	16.9	20.3	14.3	14.3	128
136	13.2	13.2	18.5	21.4	18.1	20.1	17.1	20.1	15.5	19.3	14.6	18.7	12.9	12.9	136
144	-	-	12.5	12.8	16.2	19.2	15.1	19.0	13.5	17.9	12.8	17.0	11.7	11.7	144
152	-	-	-	-	13.0	16.9	13.5	17.4	11.7	16.5	11.9	15.7	10.4	10.4	152
160	-	-	-	-	-	-	11.8	15.6	10.2	14.8	10.5	14.0	9.2	9.4	160
168	-	-	-	-	-	-	-	-	8.9	13.4	9.0	12.5	7.7	8.6	168
176	-	-	-	-	-	-	-	-	8.3	11.9	7.7	11.0	6.4	7.6	176
184	-	-	-	-	-	-	-	-	-	-	6.6	9.8	5.3	6.8	184
192	-	-	-	-	-	-	-	-	-	-	-	-	4.2	6.0	192
200	-	-	-	-	-	-	-	-	-	-	-	-	3.3	5.4	200
208	-	-	-	-	-	-	-	-	-	-	-	-	-	4.8	208
216	-	-	-	-	-	-	-	-	-	-	-	-	-	4.2	216
1)	7.3	7.3	5.1	5.1	3.7	3.7	-	-	-	-	-	-	-	-	1)

1) Capacities with horizontal boom

* Max. values are valid only for specific superstructure positions

41,200 lb		27.60 ft x 29.10 ft						360° / Max.*						85%	
ft	360° 41.7ft	Max. 41.7ft	360° 55.4ft	Max. 55.4ft	360° 69.6ft	Max. 69.6ft	360° 83.3ft	Max. 83.3ft	360° 97.4ft	Max. 97.4ft	360° 111.2ft	Max. 111.2ft	360° 125.3ft	Max. 125.3ft	ft
1,000 lb															
10	286.6	286.6	286.6	286.6	286.6	286.6	263.3	263.3	-	-	-	-	-	-	10
12	283.5	285.9	283.8	286.3	283.8	285.6	262.0	262.0	-	-	-	-	-	-	12
14	266.1	272.9	267.8	274.5	267.8	272.0	259.5	259.5	205.6	205.6	-	-	-	-	14
16	241.9	243.7	244.1	245.7	244.1	245.3	243.0	243.2	202.9	202.9	-	-	-	-	16
18	217.5	217.7	219.8	219.8	219.8	219.8	218.6	218.6	198.5	200.2	159.2	159.2	-	-	18
20	193.7	193.7	196.1	196.1	196.1	196.1	194.7	194.7	190.8	195.0	157.1	158.6	129.8	129.8	20
24	156.2	156.2	158.4	158.4	158.4	158.4	159.5	160.5	148.2	159.0	140.1	152.3	125.0	128.9	24
28	126.7	129.8	130.7	132.6	133.0	134.3	128.7	133.8	123.1	132.3	117.0	131.4	107.3	125.8	28
32	84.7	86.2	104.7	113.4	106.6	114.5	106.2	114.1	104.5	114.9	97.8	114.5	91.5	112.7	32
36	-	-	86.0	99.3	87.6	100.3	90.8	99.8	88.3	101.6	83.8	100.3	78.8	98.5	36
40	-	-	71.7	86.6	74.3	87.6	74.8	89.8	73.5	88.9	71.1	87.6	68.3	85.8	40
48	-	-	-	-	54.4	70.3	54.8	72.3	53.5	71.4	54.2	70.2	54.1	69.0	48
56	-	-	-	-	41.5	59.7	41.7	59.9	43.4	59.0	42.8	57.7	41.5	57.1	56
64	-	-	-	-	-	-	34.4	50.6	34.7	49.6	33.8	48.4	34.0	48.8	64
72	-	-	-	-	-	-	28.6	42.5	28.1	41.2	28.7	40.9	28.3	41.6	72
80	-	-	-	-	-	-	-	-	23.4	34.2	24.1	35.6	23.6	34.1	80
88	-	-	-	-	-	-	-	-	18.7	18.7	20.4	29.9	19.8	28.4	88
96	-	-	-	-	-	-	-	-	-	-	17.4	25.5	17.3	25.0	96
104	-	-	-	-	-	-	-	-	-	-	14.8	18.0	14.7	22.3	104
112	-	-	-	-	-	-	-	-	-	-	-	-	12.5	14.7	112
120	-	-	-	-	-	-	-	-	-	-	-	-	10.6	13.6	120
1)	46.7	46.7	34.2	34.2	26.2	26.2	20.7	20.7	16.5	16.5	13.0	13.0	10.1	10.1	1)

ft	360° 139.1ft	Max. 139.1ft	360° 153.2ft	Max. 153.2ft	360° 166.3ft	Max. 166.3ft	360° 180.1ft	Max. 180.1ft	360° 194.9ft	Max. 194.9ft	360° 209.0ft	Max. 209.0ft	360° 229.7ft	Max. 229.7ft	ft
1,000 lb															
24	105.2	105.2	-	-	-	-	-	-	-	-	-	-	-	-	24
28	98.4	102.5	-	-	-	-	-	-	-	-	-	-	-	-	28
32	86.1	97.0	79.0	83.7	-	-	-	-	-	-	-	-	-	-	32
36	75.4	90.5	70.2	80.1	64.4	71.0	-	-	-	-	-	-	-	-	36
40	66.4	83.5	62.7	75.5	60.5	69.3	56.5	59.2	-	-	-	-	-	-	40
48	51.2	65.2	50.7	62.3	48.4	59.3	47.9	55.3	43.9	49.7	40.3	42.2	-	-	48
56	41.6	55.3	41.1	51.6	40.8	48.8	38.2	47.6	35.6	44.9	33.2	41.4	29.9	31.2	56
64	34.0	45.7	34.0	43.6	32.8	42.9	32.2	40.9	30.0	39.1	27.5	36.9	24.8	30.2	64
72	27.9	39.0	27.5	37.6	27.0	36.2	26.6	36.3	24.6	33.0	22.2	30.8	19.7	28.7	72
80	23.4	32.6	22.7	32.5	22.9	32.1	21.8	30.8	20.1	27.7	18.2	26.9	15.8	24.5	80
88	19.8	28.6	18.9	28.1	18.9	28.4	17.8	26.2	16.5	23.6	14.8	23.0	12.5	20.4	88
96	16.5	24.7	15.5	25.0	15.7	24.4	14.6	22.6	13.2	21.0	11.7	19.5	9.6	17.2	96
104	13.8	22.0	12.9	21.8	13.1	20.7	11.8	19.5	10.5	18.6	9.3	16.6	7.3	14.4	104
112	11.6	19.2	10.7	18.8	10.7	17.7	9.6	17.3	8.3	16.2	7.2	14.2	5.2	12.0	112
120	9.8	16.7	8.8	16.2	8.9	15.1	7.8	15.1	6.5	13.8	5.1	12.1	3.6	10.1	120
128	8.1	14.1	7.2	14.0	7.3	13.1	6.2	13.0	5.0	11.8	3.6	10.2	-	8.1	128
136	6.9	13.0	5.8	12.1	6.0	12.1	4.7	11.0	3.6	9.9	-	8.5	-	6.7	136
144	-	-	-	7.8	4.7	10.7	3.6	9.5	2.3	8.2	-	6.9	-	5.4	144
152	-	-	-	-	-	7.2	-	8.0	-	6.9	-	5.6	-	4.0	152
160	-	-	-	-	-	-	-	6.9	-	5.6	-	4.5	-	3.0	160
168	-	-	-	-	-	-	-	-	-	4.6	-	3.5	-	-	168
176	-	-	-	-	-	-	-	-	-	3.7	-	2.6	-	-	176
1)	7.3	7.3	4.9	5.1	3.1	3.7	-	-	-	-	-	-	-	-	1)

1) Capacities with horizontal boom

* Max. values are valid only for specific superstructure positions

0 lb		27.60 ft x 29.10 ft										360° / Max.*				85%
ft	360° 41.7ft	Max. 41.7ft	360° 55.4ft	Max. 55.4ft	360° 69.6ft	Max. 69.6ft	360° 83.3ft	Max. 83.3ft	360° 97.4ft	Max. 97.4ft	360° 111.2ft	Max. 111.2ft	360° 125.3ft	Max. 125.3ft	ft	
1,000 lb																
10	286.6	286.6	286.6	286.6	286.6	286.6	263.3	263.3	-	-	-	-	-	-	10	
12	282.1	282.1	282.8	282.8	282.8	282.8	260.6	262.0	-	-	-	-	-	-	12	
14	256.4	256.7	258.6	258.8	256.2	258.8	230.9	252.2	198.1	205.6	-	-	-	-	14	
16	222.1	222.3	224.6	224.6	208.1	224.6	190.8	223.3	168.7	202.9	-	-	-	-	16	
18	194.0	194.7	189.0	197.1	172.6	197.1	159.6	196.0	144.4	189.5	134.3	159.2	-	-	18	
20	166.3	170.0	157.8	172.4	145.4	173.9	137.7	174.8	126.2	173.1	113.1	156.4	103.9	129.4	20	
24	108.5	136.8	112.6	140.4	109.6	141.6	102.7	141.1	94.2	138.3	88.7	135.9	82.7	116.0	24	
28	73.6	113.3	83.3	116.6	84.1	117.8	79.6	117.4	74.7	116.2	72.3	102.9	67.5	92.3	28	
32	52.9	82.3	61.1	99.1	64.4	100.2	63.7	102.2	63.3	92.8	59.0	83.1	56.5	77.9	32	
36	-	-	48.3	86.3	51.3	85.1	52.4	85.5	52.7	76.6	49.5	70.4	48.7	66.7	36	
40	-	-	37.7	75.4	42.3	75.1	43.7	69.5	43.2	62.4	43.5	61.8	41.0	55.9	40	
48	-	-	-	-	29.6	50.6	30.9	49.5	31.8	49.1	31.7	45.8	30.8	43.4	48	
56	-	-	-	-	21.5	36.7	22.6	37.6	23.7	38.0	23.5	36.7	23.5	35.8	56	
64	-	-	-	-	-	-	16.9	30.1	18.0	29.7	17.8	30.3	17.8	29.6	64	
72	-	-	-	-	-	-	12.7	24.2	13.8	24.6	13.5	24.8	13.5	24.2	72	
80	-	-	-	-	-	-	-	-	10.6	20.4	10.3	20.4	10.2	20.4	80	
88	-	-	-	-	-	-	-	-	8.1	17.3	7.7	17.1	7.7	17.0	88	
96	-	-	-	-	-	-	-	-	-	-	5.6	14.3	5.5	14.0	96	
104	-	-	-	-	-	-	-	-	-	-	3.9	11.9	3.7	11.7	104	
112	-	-	-	-	-	-	-	-	-	-	-	-	-	9.8	112	
120	-	-	-	-	-	-	-	-	-	-	-	-	-	8.1	120	
1)	46.7	46.7	27.3	34.2	17.4	26.2	11.5	20.7	7.5	16.5	4.2	12.1	-	8.6	1)	

ft	360° 139.1ft	Max. 139.1ft	360° 153.2ft	Max. 153.2ft	360° 166.3ft	Max. 166.3ft	360° 180.1ft	Max. 180.1ft	360° 194.9ft	Max. 194.9ft	360° 209.0ft	Max. 209.0ft	360° 229.7ft	Max. 229.7ft	ft
1,000 lb															
24	73.1	99.8	-	-	-	-	-	-	-	-	-	-	-	-	24
28	63.9	84.5	-	-	-	-	-	-	-	-	-	-	-	-	28
32	54.0	71.6	50.9	67.3	-	-	-	-	-	-	-	-	-	-	32
36	45.7	61.2	43.2	57.3	41.7	53.1	-	-	-	-	-	-	-	-	36
40	38.4	52.9	36.3	51.8	35.2	47.4	32.1	44.9	-	-	-	-	-	-	40
48	28.7	42.5	27.0	40.3	26.2	38.9	23.6	35.9	20.8	32.4	16.6	27.7	-	-	48
56	21.9	34.1	20.5	32.3	19.9	31.3	17.6	28.7	15.1	25.6	12.6	22.7	9.9	19.8	56
64	16.8	27.8	15.5	26.4	15.2	25.6	13.0	23.1	10.7	20.4	8.3	17.8	5.4	15.2	64
72	12.7	23.0	11.5	21.7	11.3	21.0	9.3	18.8	7.1	16.2	4.7	14.0	-	11.5	72
80	9.3	19.3	8.4	18.0	8.4	17.4	6.5	15.4	4.2	13.0	-	10.9	-	8.6	80
88	6.8	16.2	5.7	15.0	5.9	14.5	4.1	12.5	-	10.4	-	8.4	-	6.0	88
96	4.8	13.4	3.7	12.4	3.9	12.1	-	10.1	-	8.1	-	6.2	-	3.7	96
104	3.1	10.9	-	10.0	-	10.0	-	8.2	-	6.2	-	4.2	-	-	104
112	-	8.9	-	8.1	-	8.1	-	6.5	-	4.5	-	-	-	-	112
120	-	7.3	-	6.5	-	6.5	-	5.0	-	3.0	-	-	-	-	120
128	-	5.8	-	5.0	-	5.0	-	3.7	-	-	-	-	-	-	128
136	-	4.7	-	3.8	-	3.8	-	2.7	-	-	-	-	-	-	136
144	-	-	-	-	-	2.7	-	-	-	-	-	-	-	-	144
1)	-	5.3	-	-	-	-	-	-	-	-	-	-	-	-	1)

1) Capacities with horizontal boom

* Max. values are valid only for specific superstructure positions

154,800 lb		23.00 ft x 29.10 ft						360° / Max.*						85%	
ft	360° 41.7ft	Max. 41.7ft	360° 55.4ft	Max. 55.4ft	360° 69.6ft	Max. 69.6ft	360° 83.3ft	Max. 83.3ft	360° 97.4ft	Max. 97.4ft	360° 111.2ft	Max. 111.2ft	360° 125.3ft	Max. 125.3ft	ft
1,000 lb															
10	286.6	286.6	286.6	286.6	286.6	286.6	263.3	263.3	-	-	-	-	-	-	10
12	282.8	285.9	283.1	286.3	283.1	285.6	262.0	262.0	-	-	-	-	-	-	12
14	263.9	273.8	265.0	274.9	265.0	273.3	257.7	259.5	205.6	205.6	-	-	-	-	14
16	241.3	251.3	242.4	253.2	242.4	252.7	242.2	248.8	202.9	202.9	-	-	-	-	16
18	223.0	233.1	224.4	235.0	224.5	235.0	224.1	232.7	200.2	200.2	159.2	159.2	-	-	18
20	205.9	216.2	207.6	217.8	207.9	217.8	207.0	216.7	197.0	197.0	158.6	158.6	129.8	129.8	20
24	179.0	189.1	180.6	190.6	180.8	190.8	179.9	189.9	181.4	184.7	157.4	157.4	128.9	128.9	24
28	156.2	160.8	159.3	169.0	159.4	169.1	158.4	168.1	159.9	168.5	153.7	154.3	126.9	126.9	28
32	92.7	92.7	141.9	149.0	142.0	149.0	143.4	148.0	142.6	149.4	141.1	145.9	123.8	123.8	32
36	-	-	123.9	132.4	123.9	132.3	125.8	131.7	124.5	132.8	122.7	131.2	116.3	119.8	36
40	-	-	104.6	114.6	107.7	117.1	108.2	119.1	106.7	117.8	108.3	116.0	106.7	114.6	40
48	-	-	-	-	82.5	94.4	82.0	96.2	83.8	94.8	82.5	95.3	80.5	94.9	48
56	-	-	-	-	65.4	72.6	67.6	80.0	66.6	79.5	65.3	80.3	63.5	78.5	56
64	-	-	-	-	-	-	55.5	67.8	54.6	69.2	53.3	68.0	52.1	66.5	64
72	-	-	-	-	-	-	46.7	51.3	45.8	59.3	44.5	58.0	44.6	56.0	72
80	-	-	-	-	-	-	-	-	39.3	50.2	38.0	49.6	39.5	47.6	80
88	-	-	-	-	-	-	-	-	18.7	18.7	34.6	43.1	34.2	41.1	88
96	-	-	-	-	-	-	-	-	-	-	31.1	36.7	29.9	35.9	96
104	-	-	-	-	-	-	-	-	-	-	18.0	18.0	26.4	33.9	104
112	-	-	-	-	-	-	-	-	-	-	-	-	14.7	14.7	112
120	-	-	-	-	-	-	-	-	-	-	-	-	13.6	13.6	120
1)	46.7	46.7	34.2	34.2	26.2	26.2	20.7	20.7	16.5	16.5	13.0	13.0	10.1	10.1	1)

ft	360° 139.1ft	Max. 139.1ft	360° 153.2ft	Max. 153.2ft	360° 166.3ft	Max. 166.3ft	360° 180.1ft	Max. 180.1ft	360° 194.9ft	Max. 194.9ft	360° 209.0ft	Max. 209.0ft	360° 229.7ft	Max. 229.7ft	ft
1,000 lb															
24	105.2	105.2	-	-	-	-	-	-	-	-	-	-	-	-	24
28	102.5	102.5	-	-	-	-	-	-	-	-	-	-	-	-	28
32	97.0	97.0	83.7	83.7	-	-	-	-	-	-	-	-	-	-	32
36	90.5	90.5	80.1	80.1	71.0	71.0	-	-	-	-	-	-	-	-	36
40	84.2	84.2	76.0	76.0	69.6	69.6	59.2	59.2	-	-	-	-	-	-	40
48	73.3	73.3	67.1	67.1	63.1	63.1	56.8	56.8	49.8	49.8	42.2	42.2	-	-	48
56	62.6	64.7	59.1	59.1	56.4	56.4	52.0	52.0	47.9	47.9	41.4	41.4	31.2	31.2	56
64	52.1	57.0	50.5	51.9	49.5	50.1	46.9	46.9	44.4	44.4	39.7	39.7	30.2	30.2	64
72	44.1	50.8	42.3	45.8	42.7	44.7	42.0	42.2	40.4	40.4	37.1	37.1	28.7	28.7	72
80	37.5	45.7	35.9	41.3	36.2	39.7	36.5	37.9	36.4	36.7	34.6	34.6	27.0	27.0	80
88	33.1	41.4	31.9	37.4	31.1	35.6	31.7	34.0	31.7	33.2	31.6	31.9	24.6	24.6	88
96	28.8	37.2	28.7	34.0	28.0	32.1	28.7	30.7	28.3	30.0	27.7	29.0	22.3	22.3	96
104	25.3	32.7	25.7	30.6	25.5	29.2	25.3	27.7	24.9	27.2	24.2	26.3	20.1	20.1	104
112	23.5	28.9	22.8	27.1	23.1	26.8	22.8	25.2	21.9	24.8	21.2	24.1	18.0	18.0	112
120	21.5	25.8	20.7	24.2	21.3	24.2	20.4	23.2	19.3	22.5	18.7	22.0	15.9	15.9	120
128	14.9	18.0	19.3	23.0	19.1	21.4	18.3	21.6	17.2	20.7	16.5	20.3	14.3	14.3	128
136	13.2	13.2	17.6	21.4	17.2	20.1	16.5	20.1	15.4	19.3	14.7	18.7	12.9	12.9	136
144	-	-	12.5	12.8	15.5	19.2	14.8	19.0	13.7	17.9	13.1	17.0	11.7	11.7	144
152	-	-	-	-	13.0	16.9	13.3	17.4	12.2	16.5	12.0	15.7	10.4	10.4	152
160	-	-	-	-	-	-	12.0	15.6	10.9	14.8	10.9	14.0	9.4	9.4	160
168	-	-	-	-	-	-	-	-	9.8	13.4	9.9	12.5	8.6	8.6	168
176	-	-	-	-	-	-	-	-	8.8	11.9	9.0	11.0	7.6	7.6	176
184	-	-	-	-	-	-	-	-	-	-	8.0	9.8	6.8	6.8	184
192	-	-	-	-	-	-	-	-	-	-	-	-	6.0	6.0	192
200	-	-	-	-	-	-	-	-	-	-	-	-	5.0	5.4	200
208	-	-	-	-	-	-	-	-	-	-	-	-	4.2	4.8	208
216	-	-	-	-	-	-	-	-	-	-	-	-	3.4	4.2	216
1)	7.3	7.3	5.1	5.1	3.7	3.7	-	-	-	-	-	-	-	-	1)

1) Capacities with horizontal boom

* Max. values are valid only for specific superstructure positions

113,800 lb		23.00 ft x 29.10 ft						360° / Max.*						85%	
ft	360° 41.7ft	Max. 41.7ft	360° 55.4ft	Max. 55.4ft	360° 69.6ft	Max. 69.6ft	360° 83.3ft	Max. 83.3ft	360° 97.4ft	Max. 97.4ft	360° 111.2ft	Max. 111.2ft	360° 125.3ft	Max. 125.3ft	ft
1,000 lb															
10	286.6	286.6	286.6	286.6	286.6	286.6	263.3	263.3	-	-	-	-	-	-	10
12	281.0	285.9	281.7	286.3	281.7	285.6	262.0	262.0	-	-	-	-	-	-	12
14	259.0	273.8	260.6	274.9	260.6	273.3	255.4	259.5	205.6	205.6	-	-	-	-	14
16	236.9	251.3	238.0	253.2	238.0	252.7	237.8	248.8	202.9	202.9	-	-	-	-	16
18	218.9	233.1	220.2	235.0	220.2	235.0	219.9	232.7	200.2	200.2	159.2	159.2	-	-	18
20	202.2	216.1	203.7	217.7	203.7	217.6	203.0	216.5	196.6	197.0	158.6	158.6	129.8	129.8	20
24	175.6	185.6	177.4	187.5	177.4	187.3	176.5	186.2	177.1	182.9	154.7	157.4	128.9	128.9	24
28	148.0	157.5	150.3	159.9	150.3	159.8	152.1	158.7	149.7	160.5	137.2	152.8	126.3	126.9	28
32	89.5	92.7	120.2	137.5	121.6	137.5	122.9	139.4	121.1	137.9	120.8	136.2	113.6	123.8	32
36	-	-	101.4	120.6	102.6	120.5	102.2	122.5	102.2	120.9	102.8	119.2	97.8	115.7	36
40	-	-	84.0	103.9	85.0	108.0	87.7	107.4	86.6	105.8	85.3	107.8	83.1	106.0	40
48	-	-	-	-	66.0	87.0	66.2	86.5	65.3	87.5	64.0	87.0	64.0	85.2	48
56	-	-	-	-	52.2	68.5	52.4	71.8	51.5	73.2	51.2	71.9	51.5	70.3	56
64	-	-	-	-	-	-	42.7	62.8	41.9	62.0	43.1	60.9	42.1	59.2	64
72	-	-	-	-	-	-	35.6	51.2	36.7	53.5	36.1	52.2	35.0	50.7	72
80	-	-	-	-	-	-	-	-	31.5	46.8	30.8	45.6	30.6	43.9	80
88	-	-	-	-	-	-	-	-	18.7	18.7	26.5	40.3	26.5	38.5	88
96	-	-	-	-	-	-	-	-	-	-	23.3	35.8	23.7	35.7	96
104	-	-	-	-	-	-	-	-	-	-	18.0	18.0	20.8	33.0	104
112	-	-	-	-	-	-	-	-	-	-	-	-	14.7	14.7	112
120	-	-	-	-	-	-	-	-	-	-	-	-	13.6	13.6	120
1)	46.7	46.7	34.2	34.2	26.2	26.2	20.7	20.7	16.5	16.5	13.0	13.0	10.1	10.1	1)

ft	360° 139.1ft	Max. 139.1ft	360° 153.2ft	Max. 153.2ft	360° 166.3ft	Max. 166.3ft	360° 180.1ft	Max. 180.1ft	360° 194.9ft	Max. 194.9ft	360° 209.0ft	Max. 209.0ft	360° 229.7ft	Max. 229.7ft	ft
1,000 lb															
24	105.2	105.2	-	-	-	-	-	-	-	-	-	-	-	-	24
28	102.5	102.5	-	-	-	-	-	-	-	-	-	-	-	-	28
32	97.0	97.0	83.7	83.7	-	-	-	-	-	-	-	-	-	-	32
36	89.6	90.5	80.1	80.1	71.0	71.0	-	-	-	-	-	-	-	-	36
40	81.8	84.2	75.5	76.0	69.4	69.6	59.2	59.2	-	-	-	-	-	-	40
48	62.9	73.3	61.5	67.1	59.5	63.1	56.2	56.8	49.8	49.8	42.2	42.2	-	-	48
56	50.2	64.7	49.7	59.1	48.6	56.4	48.1	52.0	46.5	47.9	41.4	41.4	31.2	31.2	56
64	41.0	57.0	41.2	51.9	41.0	50.1	40.5	46.9	39.9	44.4	38.8	39.7	30.2	30.2	64
72	35.1	50.0	34.5	45.8	35.4	44.7	34.5	42.2	33.4	40.4	32.8	37.1	28.7	28.7	72
80	30.2	44.5	30.2	41.3	30.1	39.7	29.3	37.9	28.2	36.7	27.5	34.6	26.8	27.0	80
88	26.1	39.7	26.7	37.4	25.8	35.6	25.0	34.0	23.9	33.2	24.1	31.9	23.2	24.6	88
96	23.4	35.2	23.2	33.5	22.4	32.1	21.6	30.7	21.0	30.0	20.7	29.0	19.7	22.3	96
104	20.6	31.3	20.4	29.6	19.5	29.2	18.9	27.7	18.6	27.2	17.8	26.3	16.9	20.1	104
112	18.2	28.1	18.0	26.3	17.1	26.7	17.1	25.2	16.4	24.8	15.5	24.1	14.4	18.0	112
120	16.3	25.2	15.9	24.2	15.0	23.8	15.2	23.2	14.3	22.5	13.4	22.0	12.6	15.9	120
128	14.1	17.8	14.1	22.9	13.2	21.3	13.4	21.6	12.6	20.7	11.7	20.3	10.8	14.3	128
136	13.2	13.2	12.6	21.4	12.1	20.1	11.8	20.1	11.1	19.3	10.2	18.7	9.2	12.9	136
144	-	-	9.3	12.8	11.1	19.2	10.6	19.0	9.8	17.9	8.9	17.0	8.0	11.7	144
152	-	-	-	-	8.2	16.9	9.3	17.4	8.5	16.5	7.6	15.7	6.4	10.4	152
160	-	-	-	-	-	8.3	15.6	7.5	14.8	6.5	14.0	5.2	9.4	9.4	160
168	-	-	-	-	-	-	-	6.6	13.4	5.4	12.5	4.2	8.6	168	168
176	-	-	-	-	-	-	-	5.6	11.9	4.3	11.0	3.2	7.6	176	176
184	-	-	-	-	-	-	-	-	-	3.5	9.8	-	6.8	184	184
192	-	-	-	-	-	-	-	-	-	-	-	-	6.0	192	192
200	-	-	-	-	-	-	-	-	-	-	-	-	5.4	200	200
208	-	-	-	-	-	-	-	-	-	-	-	-	4.8	208	208
216	-	-	-	-	-	-	-	-	-	-	-	-	4.2	216	216
1)	7.3	7.3	5.1	5.1	3.7	3.7	-	-	-	-	-	-	-	-	1)

1) Capacities with horizontal boom

* Max. values are valid only for specific superstructure positions

41,200 lb		23.00 ft x 29.10 ft						360° / Max.*						85%	
ft	360° 41.7ft	Max. 41.7ft	360° 55.4ft	Max. 55.4ft	360° 69.6ft	Max. 69.6ft	360° 83.3ft	Max. 83.3ft	360° 97.4ft	Max. 97.4ft	360° 111.2ft	Max. 111.2ft	360° 125.3ft	Max. 125.3ft	ft
1,000 lb															
10	286.3	286.6	286.4	286.6	286.4	286.6	263.3	263.3	-	-	-	-	-	-	10
12	276.3	285.9	277.4	286.3	277.4	285.6	259.2	262.0	-	-	-	-	-	-	12
14	250.7	272.9	252.3	274.5	252.3	272.0	229.7	259.5	197.3	205.6	-	-	-	-	14
16	228.9	243.7	231.1	245.7	215.4	245.3	194.7	243.2	169.5	202.9	-	-	-	-	16
18	200.3	217.7	200.8	219.8	180.5	219.8	165.4	218.6	146.8	200.2	136.7	159.2	-	-	18
20	169.2	193.7	168.3	195.9	156.0	195.9	140.2	194.6	131.7	195.0	118.5	158.6	109.3	129.8	20
24	110.7	156.2	116.5	158.3	116.8	158.3	113.8	160.5	103.7	159.0	96.0	152.3	90.1	128.9	24
28	79.9	129.8	86.5	132.6	89.3	134.3	89.5	133.8	84.3	132.3	79.9	131.4	75.0	124.5	28
32	61.0	86.2	66.9	113.4	69.3	114.5	69.8	114.1	68.9	114.9	69.2	114.5	64.6	107.8	32
36	-	-	54.8	99.3	57.1	100.3	57.5	99.8	59.0	101.6	58.2	100.2	56.0	90.7	36
40	-	-	44.6	86.6	47.2	87.6	49.0	89.8	48.7	88.9	48.3	87.0	48.7	80.4	40
48	-	-	-	-	35.5	69.6	36.4	71.9	35.9	71.0	36.8	65.4	36.4	62.4	48
56	-	-	-	-	27.3	56.4	28.0	56.7	28.5	55.6	28.7	52.6	28.7	52.3	56
64	-	-	-	-	-	-	22.2	44.1	23.1	43.1	22.9	44.0	22.9	42.8	64
72	-	-	-	-	-	-	17.9	35.7	18.8	36.9	18.6	36.3	18.6	34.5	72
80	-	-	-	-	-	-	-	-	15.5	30.9	15.5	30.1	15.5	29.8	80
88	-	-	-	-	-	-	-	-	13.2	18.7	12.9	25.5	12.9	26.0	88
96	-	-	-	-	-	-	-	-	-	-	10.9	22.5	10.7	22.4	96
104	-	-	-	-	-	-	-	-	-	-	9.2	18.0	9.0	19.6	104
112	-	-	-	-	-	-	-	-	-	-	-	-	7.6	14.7	112
120	-	-	-	-	-	-	-	-	-	-	-	-	6.4	13.6	120
1)	46.7	46.7	34.2	34.2	23.1	26.2	16.8	20.7	12.8	16.5	9.3	13.0	6.8	10.1	1)

ft	360° 139.1ft	Max. 139.1ft	360° 153.2ft	Max. 153.2ft	360° 166.3ft	Max. 166.3ft	360° 180.1ft	Max. 180.1ft	360° 194.9ft	Max. 194.9ft	360° 209.0ft	Max. 209.0ft	360° 229.7ft	Max. 229.7ft	ft
1,000 lb															
24	80.9	105.2	-	-	-	-	-	-	-	-	-	-	-	-	24
28	71.7	102.5	-	-	-	-	-	-	-	-	-	-	-	-	28
32	60.9	97.0	59.2	83.7	-	-	-	-	-	-	-	-	-	-	32
36	54.4	84.1	52.3	75.7	47.5	68.6	-	-	-	-	-	-	-	-	36
40	47.9	73.1	45.5	68.0	44.0	65.9	40.9	58.4	-	-	-	-	-	-	40
48	36.4	58.9	35.5	56.3	34.8	53.7	32.4	49.8	29.3	46.7	25.5	41.8	-	-	48
56	28.1	47.6	27.3	46.1	27.5	44.4	26.0	43.4	23.3	39.7	21.0	37.0	18.5	31.2	56
64	22.3	39.8	21.5	38.6	21.6	38.2	20.7	36.1	18.7	32.8	16.7	31.5	14.4	28.5	64
72	17.9	34.7	17.3	33.6	17.3	33.0	16.4	30.1	15.1	28.8	13.1	26.4	11.1	23.7	72
80	14.8	29.1	14.1	29.6	14.1	28.2	13.2	26.0	12.1	24.6	10.2	22.0	8.3	19.5	80
88	12.3	25.6	11.6	25.3	11.6	23.8	10.7	22.9	9.6	21.3	7.9	18.8	6.1	16.4	88
96	10.3	22.2	9.6	21.8	9.6	20.0	8.7	19.9	7.6	18.0	6.0	16.0	4.1	13.8	96
104	8.6	19.1	7.9	18.9	7.9	17.5	7.0	17.0	5.9	15.3	4.4	13.3	2.6	11.3	104
112	7.0	16.6	6.3	16.2	6.5	15.8	5.4	14.9	4.3	12.9	-	11.1	-	9.2	112
120	5.9	14.7	5.0	13.8	5.2	13.9	4.1	12.8	3.0	11.1	-	9.1	-	7.3	120
128	4.6	12.7	3.9	11.8	4.0	12.0	2.9	10.9	-	9.5	-	7.6	-	5.6	128
136	3.7	11.1	2.8	10.1	2.9	10.3	-	9.2	-	7.9	-	6.4	-	4.4	136
144	-	-	-	6.2	-	8.7	-	7.6	-	6.5	-	5.3	-	3.4	144
152	-	-	-	-	-	6.0	-	6.5	-	5.1	-	4.0	-	-	152
160	-	-	-	-	-	-	-	5.6	-	4.2	-	3.0	-	-	160
168	-	-	-	-	-	-	-	-	-	3.3	-	-	-	-	168
176	-	-	-	-	-	-	-	-	-	2.5	-	-	-	-	176
1)	4.2	7.3	-	5.1	-	3.7	-	-	-	-	-	-	-	-	1)

1) Capacities with horizontal boom

* Max. values are valid only for specific superstructure positions

0 lb		23.00 ft x 29.10 ft								360° / Max.*				85%	
ft	360° 41.7ft	Max. 41.7ft	360° 55.4ft	Max. 55.4ft	360° 69.6ft	Max. 69.6ft	360° 83.3ft	Max. 83.3ft	360° 97.4ft	Max. 97.4ft	360° 111.2ft	Max. 111.2ft	360° 125.3ft	Max. 125.3ft	ft
1,000 lb															
10	285.8	286.6	285.9	286.6	280.4	286.6	237.1	263.3	-	-	-	-	-	-	10
12	270.8	282.0	257.4	282.7	215.3	282.7	174.2	262.0	-	-	-	-	-	-	12
14	223.1	256.7	189.3	258.8	159.2	258.8	142.3	252.2	121.0	205.6	-	-	-	-	14
16	162.1	222.3	143.1	224.6	129.8	224.6	114.7	223.3	102.4	202.9	-	-	-	-	16
18	123.6	194.7	116.0	197.1	108.3	197.1	96.7	196.0	90.2	184.9	80.7	154.8	-	-	18
20	91.1	170.0	96.3	172.4	89.5	173.9	83.4	174.5	77.0	162.1	72.1	146.4	64.8	122.8	20
24	57.3	136.8	65.3	140.4	67.2	141.1	64.3	133.9	61.0	121.7	56.7	106.4	52.0	94.7	24
28	39.5	113.3	46.2	116.6	50.8	111.5	50.8	105.4	49.1	93.6	45.9	83.4	42.2	76.8	28
32	28.7	82.3	34.6	94.1	38.7	90.2	39.8	83.0	40.1	72.3	38.0	70.1	35.0	64.4	32
36	-	-	27.5	76.2	31.2	74.5	32.2	68.8	33.2	62.2	32.0	58.9	29.8	54.5	36
40	-	-	21.4	61.3	24.9	59.8	25.8	55.7	26.9	55.2	26.7	51.1	25.3	48.6	40
48	-	-	-	-	17.3	42.0	18.2	43.0	19.0	41.1	19.0	39.7	18.8	38.5	48
56	-	-	-	-	12.3	32.3	13.1	33.3	14.0	32.3	13.9	32.0	13.8	30.7	56
64	-	-	-	-	-	-	9.6	25.8	10.4	26.5	10.4	25.7	10.3	25.1	64
72	-	-	-	-	-	-	7.1	20.4	7.8	21.3	7.8	21.0	7.6	20.2	72
80	-	-	-	-	-	-	-	-	5.9	17.3	5.7	17.1	5.7	16.5	80
88	-	-	-	-	-	-	-	-	4.3	14.3	4.0	14.1	3.9	14.0	88
96	-	-	-	-	-	-	-	-	-	-	-	11.7	-	11.7	96
104	-	-	-	-	-	-	-	-	-	-	-	9.7	-	9.7	104
112	-	-	-	-	-	-	-	-	-	-	-	-	-	7.9	112
120	-	-	-	-	-	-	-	-	-	-	-	-	-	6.5	120
1)	26.9	46.7	15.2	34.2	9.7	26.2	6.4	19.0	4.0	13.9	-	9.9	-	6.8	1)

ft	360° 139.1ft	Max. 139.1ft	360° 153.2ft	Max. 153.2ft	360° 166.3ft	Max. 166.3ft	360° 180.1ft	Max. 180.1ft	360° 194.9ft	Max. 194.9ft	360° 209.0ft	Max. 209.0ft	360° 229.7ft	Max. 229.7ft	ft
1,000 lb															
24	45.6	83.5	-	-	-	-	-	-	-	-	-	-	-	-	24
28	39.0	71.6	-	-	-	-	-	-	-	-	-	-	-	-	28
32	32.3	60.4	30.0	56.7	-	-	-	-	-	-	-	-	-	-	32
36	27.4	52.6	25.4	49.4	24.3	46.1	-	-	-	-	-	-	-	-	36
40	23.1	45.0	21.3	42.6	20.5	41.1	18.1	37.1	-	-	-	-	-	-	40
48	17.0	35.2	15.6	33.0	15.1	32.1	13.0	29.5	10.6	25.9	7.0	21.8	-	-	48
56	12.7	28.6	11.4	26.3	11.0	25.4	9.2	23.2	7.0	20.7	5.1	18.1	-	15.2	56
64	9.4	23.3	8.3	21.8	7.9	20.7	6.3	18.5	4.2	16.2	-	14.0	-	11.6	64
72	6.9	19.0	5.8	17.9	5.6	17.1	3.8	14.8	-	12.6	-	10.7	-	8.7	72
80	4.8	15.8	3.7	14.5	3.5	14.3	-	12.2	-	9.8	-	8.0	-	5.8	80
88	3.2	12.5	-	11.7	-	11.8	-	9.9	-	7.7	-	5.6	-	3.5	88
96	-	10.3	-	9.2	-	9.3	-	7.9	-	6.0	-	3.9	-	-	96
104	-	8.6	-	7.4	-	7.3	-	6.0	-	4.2	-	2.4	-	-	104
112	-	7.2	-	6.1	-	5.7	-	4.6	-	-	-	-	-	-	112
120	-	5.6	-	4.8	-	4.4	-	3.2	-	-	-	-	-	-	120
128	-	4.4	-	3.5	-	3.4	-	-	-	-	-	-	-	-	128
136	-	3.5	-	2.4	-	2.6	-	-	-	-	-	-	-	-	136
1)	-	4.0	-	-	-	-	-	-	-	-	-	-	-	-	1)

1) Capacities with horizontal boom

* Max. values are valid only for specific superstructure positions

113,800 lb		18.20 ft x 29.10 ft						360° / Max.*						85%	
ft	360° 41.7ft	Max. 41.7ft	360° 55.4ft	Max. 55.4ft	360° 69.6ft	Max. 69.6ft	360° 83.3ft	Max. 83.3ft	360° 97.4ft	Max. 97.4ft	360° 111.2ft	Max. 111.2ft	360° 125.3ft	Max. 125.3ft	ft
1,000 lb															
10	-	286.6	-	286.6	-	286.6	-	263.3	-	-	-	-	-	-	10
12	-	285.9	-	286.3	-	285.6	-	262.0	-	-	-	-	-	-	12
14	-	273.8	-	274.9	-	273.3	-	259.5	-	205.6	-	-	-	-	14
16	-	251.3	-	253.2	-	252.7	-	248.8	-	202.9	-	-	-	-	16
18	-	233.1	-	235.0	-	235.0	-	232.7	-	200.2	-	159.2	-	-	18
20	184.7	216.1	186.8	217.7	186.8	217.6	187.6	216.5	170.6	197.0	153.7	158.6	129.6	129.8	20
24	145.4	185.6	148.3	187.5	149.9	187.3	148.8	186.2	138.4	182.9	133.3	157.4	121.8	128.9	24
28	111.1	157.5	115.4	159.9	116.6	159.8	116.2	158.7	118.0	160.5	112.1	152.8	103.1	126.9	28
32	81.1	92.7	92.5	137.5	93.9	137.5	96.5	139.4	95.6	137.9	93.7	136.2	90.2	123.8	32
36	-	-	78.4	120.6	81.2	120.5	81.5	122.5	80.6	120.9	79.1	119.2	77.4	115.7	36
40	-	-	66.5	103.9	68.3	108.0	68.7	107.4	67.6	105.8	67.4	107.8	67.9	106.0	40
48	-	-	-	-	52.2	87.0	52.4	86.5	51.5	87.5	53.2	87.0	51.9	85.2	48
56	-	-	-	-	41.5	68.5	41.6	71.8	43.0	73.2	42.3	71.9	41.7	70.3	56
64	-	-	-	-	-	-	34.7	62.8	35.1	62.0	34.6	60.9	34.5	59.2	64
72	-	-	-	-	-	-	29.7	51.2	29.4	53.5	29.0	52.2	29.4	50.7	72
80	-	-	-	-	-	-	-	-	25.0	46.8	25.6	45.6	25.2	43.9	80
88	-	-	-	-	-	-	-	-	18.7	38.7	18.7	40.3	21.7	38.5	88
96	-	-	-	-	-	-	-	-	-	19.3	19.3	35.8	18.9	35.7	96
104	-	-	-	-	-	-	-	-	-	-	17.2	18.0	16.6	33.0	104
112	-	-	-	-	-	-	-	-	-	-	-	-	14.7	14.7	112
120	-	-	-	-	-	-	-	-	-	-	-	-	13.4	13.6	120
1)	46.7	46.7	34.2	34.2	26.2	26.2	20.7	20.7	16.5	16.5	13.0	13.0	10.1	10.1	1)

ft	360° 139.1ft	Max. 139.1ft	360° 153.2ft	Max. 153.2ft	360° 166.3ft	Max. 166.3ft	360° 180.1ft	Max. 180.1ft	360° 194.9ft	Max. 194.9ft	360° 209.0ft	Max. 209.0ft	360° 229.7ft	Max. 229.7ft	ft
1,000 lb															
24	104.8	105.2	-	-	-	-	-	-	-	-	-	-	-	-	24
28	96.2	102.5	-	-	-	-	-	-	-	-	-	-	-	-	28
32	85.4	97.0	78.5	83.7	-	-	-	-	-	-	-	-	-	-	32
36	75.5	90.5	71.1	80.1	65.6	71.0	-	-	-	-	-	-	-	-	36
40	66.5	84.2	64.7	76.0	60.8	69.6	56.8	59.2	-	-	-	-	-	-	40
48	50.7	73.3	51.5	67.1	50.8	63.1	49.1	56.8	46.5	49.8	41.7	42.2	-	-	48
56	41.4	64.7	41.1	59.1	41.5	56.4	40.9	52.0	39.1	47.9	37.4	41.4	31.2	31.2	56
64	34.7	57.0	34.7	51.9	33.8	50.1	33.2	46.9	32.5	44.4	31.6	39.7	29.2	30.2	64
72	29.2	50.0	29.0	45.8	28.1	44.7	28.3	42.2	27.2	40.4	26.4	37.1	25.0	28.7	72
80	24.8	44.5	24.5	41.3	23.8	39.7	23.9	37.9	23.0	36.7	22.1	34.6	21.1	27.0	80
88	21.4	39.7	21.0	37.4	21.0	35.6	20.4	34.0	19.5	33.2	18.6	31.9	17.7	24.6	88
96	18.9	35.2	18.2	33.5	18.2	32.1	17.6	30.7	16.7	30.0	15.8	29.0	14.8	22.3	96
104	16.4	31.3	15.9	29.6	15.9	29.2	15.1	27.7	14.4	27.2	13.5	26.3	12.4	20.1	104
112	14.5	28.0	13.8	25.8	14.0	26.3	13.1	25.2	12.3	24.8	11.4	24.1	10.5	18.0	112
120	12.8	24.8	12.2	24.2	12.2	23.0	11.5	23.2	10.6	22.5	9.8	22.0	8.9	15.9	120
128	11.3	17.4	10.7	22.7	10.7	21.3	10.0	21.6	9.1	20.7	8.3	20.3	7.3	14.3	128
136	10.2	13.2	9.5	20.8	9.5	20.1	8.7	20.1	7.8	19.3	6.9	18.7	5.8	12.9	136
144	-	-	6.2	12.8	8.4	18.8	7.5	18.6	6.7	17.7	5.6	16.8	4.5	11.7	144
152	-	-	-	-	5.2	16.4	6.5	16.5	5.6	15.8	4.5	15.0	3.2	10.4	152
160	-	-	-	-	-	-	5.6	14.7	4.5	14.0	3.4	13.2	-	9.4	160
168	-	-	-	-	-	-	-	-	3.6	12.6	-	11.7	-	8.6	168
176	-	-	-	-	-	-	-	-	2.8	11.2	-	10.3	-	7.6	176
184	-	-	-	-	-	-	-	-	-	-	-	9.2	-	6.8	184
192	-	-	-	-	-	-	-	-	-	-	-	-	-	6.0	192
200	-	-	-	-	-	-	-	-	-	-	-	-	-	5.4	200
208	-	-	-	-	-	-	-	-	-	-	-	-	-	4.8	208
216	-	-	-	-	-	-	-	-	-	-	-	-	-	4.2	216
1)	7.3	7.3	5.1	5.1	3.7	3.7	-	-	-	-	-	-	-	-	1)

1) Capacities with horizontal boom

* Max. values are valid only for specific superstructure positions

41,200 lb		18.20 ft x 29.10 ft								360° / Max.*				85%	
ft	360° 41.7ft	Max. 41.7ft	360° 55.4ft	Max. 55.4ft	360° 69.6ft	Max. 69.6ft	360° 83.3ft	Max. 83.3ft	360° 97.4ft	Max. 97.4ft	360° 111.2ft	Max. 111.2ft	360° 125.3ft	Max. 125.3ft	ft
1,000 lb															
10	284.1	286.6	284.3	286.6	281.1	286.6	238.7	263.3	-	-	-	-	-	-	10
12	253.2	285.9	249.5	286.3	220.9	285.6	192.1	262.0	-	-	-	-	-	-	12
14	221.1	272.9	201.2	274.5	179.4	272.0	157.7	259.5	144.4	205.6	-	-	-	-	14
16	176.6	243.7	165.8	245.7	148.2	245.3	138.1	243.2	123.2	202.9	-	-	-	-	16
18	139.5	217.7	138.3	219.8	128.3	219.8	120.1	218.6	107.8	200.2	100.0	159.2	-	-	18
20	107.6	193.7	113.6	195.9	112.7	195.9	104.2	194.6	96.3	195.0	90.5	158.6	81.6	129.8	20
24	74.9	156.2	81.5	158.3	84.3	158.3	82.2	160.5	79.6	159.0	73.8	151.5	68.8	128.9	24
28	55.7	129.8	61.5	132.6	63.9	134.3	65.1	133.8	65.1	132.3	61.4	130.8	59.4	118.5	28
32	43.2	86.2	48.4	113.4	51.3	114.5	53.1	114.1	52.7	114.9	52.9	109.8	50.6	97.4	32
36	-	-	40.0	99.3	43.3	100.3	44.3	99.8	44.4	99.9	44.9	92.1	43.6	83.6	36
40	-	-	32.7	86.1	35.8	87.2	36.7	89.4	37.8	85.0	37.6	78.6	37.6	73.5	40
48	-	-	-	-	26.6	67.4	27.3	67.4	28.2	65.0	28.1	60.1	28.1	58.9	48
56	-	-	-	-	20.2	51.1	21.0	51.4	21.9	49.4	21.7	48.7	21.7	47.4	56
64	-	-	-	-	-	-	16.5	39.9	17.3	40.6	17.1	40.5	17.1	37.9	64
72	-	-	-	-	-	-	13.3	32.9	14.0	33.5	13.7	32.8	13.7	32.3	72
80	-	-	-	-	-	-	-	-	11.3	27.8	11.1	27.3	11.1	27.7	80
88	-	-	-	-	-	-	-	-	9.4	18.7	9.2	23.8	9.1	23.5	88
96	-	-	-	-	-	-	-	-	-	-	7.5	20.8	7.5	20.4	96
104	-	-	-	-	-	-	-	-	-	-	6.1	18.0	6.1	17.7	104
112	-	-	-	-	-	-	-	-	-	-	-	-	4.8	14.7	112
120	-	-	-	-	-	-	-	-	-	-	-	-	3.7	13.6	120
1)	41.0	46.7	24.9	34.2	17.2	26.2	12.1	20.7	9.0	16.5	6.4	13.0	4.0	10.1	1)

ft	360° 139.1ft	Max. 139.1ft	360° 153.2ft	Max. 153.2ft	360° 166.3ft	Max. 166.3ft	360° 180.1ft	Max. 180.1ft	360° 194.9ft	Max. 194.9ft	360° 209.0ft	Max. 209.0ft	360° 229.7ft	Max. 229.7ft	ft
1,000 lb															
24	64.1	105.2	-	-	-	-	-	-	-	-	-	-	-	-	24
28	55.5	102.5	-	-	-	-	-	-	-	-	-	-	-	-	28
32	47.4	90.0	44.8	82.0	-	-	-	-	-	-	-	-	-	-	32
36	41.4	77.6	39.1	72.1	37.7	65.6	-	-	-	-	-	-	-	-	36
40	35.8	69.1	34.0	66.5	32.9	60.7	30.3	56.6	-	-	-	-	-	-	40
48	27.4	55.2	26.5	52.5	25.8	50.1	23.5	48.6	20.9	45.1	17.4	40.8	-	-	48
56	21.0	44.9	20.4	42.8	20.4	42.4	18.5	39.7	16.3	36.1	14.1	34.1	11.8	30.5	56
64	16.5	37.7	15.8	37.1	16.0	35.2	14.6	32.7	12.6	31.5	10.6	28.5	8.5	25.9	64
72	13.1	31.4	12.4	31.7	12.6	29.7	11.5	28.5	9.5	25.9	7.8	23.7	5.8	21.2	72
80	10.7	27.5	10.0	26.2	10.0	24.9	9.1	24.5	7.2	22.0	5.6	19.5	3.7	17.3	80
88	8.6	23.0	8.0	22.7	8.0	21.3	7.1	20.6	5.3	18.8	3.6	16.5	-	14.0	88
96	6.9	19.8	6.2	19.1	6.2	19.0	5.3	17.4	3.6	15.7	-	13.8	-	11.8	96
104	5.5	17.5	4.6	16.1	4.8	16.2	3.7	15.1	-	13.1	-	11.3	-	9.3	104
112	4.1	15.1	3.2	14.2	3.2	13.6	-	12.4	-	11.1	-	9.2	-	7.2	112
120	2.9	13.0	-	12.1	-	12.1	-	10.4	-	9.3	-	7.6	-	5.6	120
128	-	11.2	-	10.2	-	10.4	-	8.9	-	7.5	-	6.3	-	4.4	128
136	-	9.6	-	8.7	-	8.7	-	7.6	-	6.0	-	4.8	-	3.2	136
144	-	-	-	4.7	-	7.3	-	6.2	-	4.9	-	3.6	-	-	144
152	-	-	-	-	-	4.9	-	5.1	-	3.9	-	-	-	-	152
160	-	-	-	-	-	-	-	4.2	-	3.1	-	-	-	-	160
1)	-	7.3	-	5.1	-	3.7	-	-	-	-	-	-	-	-	1)

1) Capacities with horizontal boom

* Max. values are valid only for specific superstructure positions

0 lb		18.20 ft x 29.10 ft										360° / Max.*				85%
ft	360° 41.7ft	Max. 41.7ft	360° 55.4ft	Max. 55.4ft	360° 69.6ft	Max. 69.6ft	360° 83.3ft	Max. 83.3ft	360° 97.4ft	Max. 97.4ft	360° 111.2ft	Max. 111.2ft	360° 125.3ft	Max. 125.3ft	ft	
1,000 lb																
10	250.4	286.6	199.6	286.6	166.0	286.6	139.8	263.3	-	-	-	-	-	-	10	
12	165.5	282.0	142.1	282.7	126.6	282.7	109.2	262.0	-	-	-	-	-	-	12	
14	119.7	256.7	111.7	258.8	100.2	258.8	91.4	252.2	83.3	205.6	-	-	-	-	14	
16	91.0	222.3	88.9	224.6	82.9	224.6	76.2	223.3	70.9	202.9	-	-	-	-	16	
18	70.7	194.7	74.1	197.1	70.9	197.1	65.5	195.6	61.6	172.4	56.4	145.7	-	-	18	
20	52.9	170.0	60.9	172.4	60.1	173.6	56.3	171.6	53.3	145.1	49.2	128.3	44.0	112.9	20	
24	34.7	136.8	41.5	139.5	45.5	132.8	43.8	121.2	42.0	107.4	38.9	94.8	35.5	88.3	24	
28	24.1	108.1	29.9	106.8	34.0	98.9	34.7	91.3	33.8	81.3	31.6	76.2	28.8	70.1	28	
32	17.3	80.1	22.5	84.3	26.1	78.4	27.2	72.3	27.6	67.3	25.9	62.9	23.9	58.3	32	
36	-	-	17.6	66.1	21.0	62.9	22.0	59.5	22.8	57.4	21.8	52.5	20.1	50.3	36	
40	-	-	13.5	52.2	16.7	52.0	17.6	50.3	18.5	48.1	18.1	46.6	16.8	43.2	40	
48	-	-	-	-	11.2	37.8	12.0	37.6	13.0	36.1	12.8	36.2	12.0	34.3	48	
56	-	-	-	-	7.5	28.7	8.3	28.7	9.2	28.9	8.9	28.1	8.6	27.5	56	
64	-	-	-	-	-	-	5.6	22.8	6.4	23.2	6.2	22.7	6.0	22.0	64	
72	-	-	-	-	-	-	3.4	18.0	4.2	18.6	4.0	18.2	4.0	17.5	72	
80	-	-	-	-	-	-	-	-	-	15.2	-	14.7	-	14.7	80	
88	-	-	-	-	-	-	-	-	-	12.4	-	12.2	-	11.8	88	
96	-	-	-	-	-	-	-	-	-	-	-	10.1	-	9.5	96	
104	-	-	-	-	-	-	-	-	-	-	-	8.4	-	7.8	104	
112	-	-	-	-	-	-	-	-	-	-	-	-	-	6.5	112	
120	-	-	-	-	-	-	-	-	-	-	-	-	-	5.3	120	
1)	16.1	46.7	9.0	34.2	5.5	23.8	2.6	16.5	-	12.1	-	8.6	-	5.5	1)	

ft	360° 139.1ft	Max. 139.1ft	360° 153.2ft	Max. 153.2ft	360° 166.3ft	Max. 166.3ft	360° 180.1ft	Max. 180.1ft	360° 194.9ft	Max. 194.9ft	360° 209.0ft	Max. 209.0ft	360° 229.7ft	Max. 229.7ft	ft
1,000 lb															
24	30.5	75.0	-	-	-	-	-	-	-	-	-	-	-	-	24
28	26.3	65.2	-	-	-	-	-	-	-	-	-	-	-	-	28
32	21.6	55.6	19.8	51.5	-	-	-	-	-	-	-	-	-	-	32
36	18.1	47.0	16.5	44.3	15.7	42.5	-	-	-	-	-	-	-	-	36
40	15.1	40.9	13.5	38.5	12.9	36.8	10.9	34.0	-	-	-	-	-	-	40
48	10.5	31.4	9.2	29.9	8.8	29.1	6.9	26.1	-	23.4	-	19.6	-	-	48
56	7.2	25.4	6.0	23.4	5.7	22.8	4.0	20.7	-	18.0	-	15.6	-	13.3	56
64	4.7	20.5	3.5	19.2	3.3	18.3	-	16.2	-	14.2	-	12.1	-	9.5	64
72	2.7	16.6	-	15.3	-	15.1	-	12.8	-	10.9	-	8.9	-	6.9	72
80	-	13.2	-	12.3	-	12.1	-	10.4	-	8.2	-	6.2	-	4.1	80
88	-	10.8	-	9.6	-	9.6	-	8.1	-	6.3	-	4.3	-	-	88
96	-	8.8	-	7.8	-	7.5	-	6.1	-	4.3	-	-	-	-	96
104	-	6.8	-	6.0	-	5.9	-	4.4	-	2.6	-	-	-	-	104
112	-	5.2	-	4.3	-	4.6	-	3.0	-	-	-	-	-	-	112
120	-	4.2	-	3.1	-	3.2	-	-	-	-	-	-	-	-	120
128	-	3.2	-	-	-	-	-	-	-	-	-	-	-	-	128
136	-	2.4	-	-	-	-	-	-	-	-	-	-	-	-	136
1)	-	2.9	-	-	-	-	-	-	-	-	-	-	-	-	1)

1) Capacities with horizontal boom

* Max. values are valid only for specific superstructure positions

0 lb		9.00 ft x 29.10 ft										360° / Max.*				85%
ft	360° 41.7ft	Max. 41.7ft	360° 55.4ft	Max. 55.4ft	360° 69.6ft	Max. 69.6ft	360° 83.3ft	Max. 83.3ft	360° 97.4ft	Max. 97.4ft	360° 111.2ft	Max. 111.2ft	360° 125.3ft	Max. 125.3ft	ft	
1,000 lb																
10	53.5	286.6	53.5	286.6	51.0	155.7	46.7	99.8	-	-	-	-	-	-	10	
12	39.9	282.0	42.4	282.7	41.5	157.1	38.6	101.2	-	-	-	-	-	-	12	
14	29.6	256.7	34.1	258.8	34.6	159.2	32.4	101.0	30.5	73.5	-	-	-	-	14	
16	21.9	222.3	27.6	224.6	29.0	164.3	27.4	102.4	26.0	74.4	-	-	-	-	16	
18	16.8	194.7	22.5	197.1	24.8	170.6	23.6	104.5	22.5	73.9	20.6	56.6	-	-	18	
20	12.3	170.0	17.8	171.2	20.9	171.2	20.1	106.7	19.2	74.9	17.7	57.2	14.9	43.5	20	
24	6.1	131.6	11.8	125.5	15.1	114.0	15.0	104.1	14.7	77.2	13.4	58.5	11.8	44.6	24	
28	-	88.2	7.5	89.7	10.8	86.8	11.2	80.6	11.3	74.1	10.1	58.5	9.0	45.5	28	
32	-	60.1	4.0	66.5	7.8	66.8	8.3	62.5	8.5	61.6	7.5	55.3	6.6	46.5	32	
36	-	-	-	51.6	5.3	53.1	6.1	52.6	6.4	50.8	5.6	48.7	4.8	43.7	36	
40	-	-	-	39.6	-	43.7	-	44.2	4.6	42.7	-	42.1	-	39.8	40	
48	-	-	-	-	-	30.8	-	31.9	-	32.1	-	31.9	-	30.8	48	
56	-	-	-	-	-	23.4	-	24.1	-	24.7	-	24.5	-	24.1	56	
64	-	-	-	-	-	-	-	18.8	-	19.5	-	19.1	-	18.9	64	
72	-	-	-	-	-	-	-	14.6	-	15.3	-	15.1	-	14.9	72	
80	-	-	-	-	-	-	-	-	-	12.4	-	11.9	-	11.9	80	
88	-	-	-	-	-	-	-	-	-	9.9	-	9.6	-	9.4	88	
96	-	-	-	-	-	-	-	-	-	-	-	7.6	-	7.4	96	
104	-	-	-	-	-	-	-	-	-	-	-	5.9	-	5.9	104	
112	-	-	-	-	-	-	-	-	-	-	-	-	-	4.3	112	
120	-	-	-	-	-	-	-	-	-	-	-	-	-	3.3	120	
1)	-	46.7	-	30.2	-	20.1	-	13.9	-	9.7	-	6.2	-	3.5	1)	

ft	360° 139.1ft	Max. 139.1ft	360° 153.2ft	Max. 153.2ft	360° 166.3ft	Max. 166.3ft	360° 180.1ft	Max. 180.1ft	360° 194.9ft	Max. 194.9ft	360° 209.0ft	Max. 209.0ft	360° 229.7ft	Max. 229.7ft	ft
1,000 lb															
24	-	33.6	-	-	-	-	-	-	-	-	-	-	-	-	24
28	-	35.7	-	-	-	-	-	-	-	-	-	-	-	-	28
32	-	36.4	-	29.0	-	-	-	-	-	-	-	-	-	-	32
36	-	37.2	-	29.5	-	24.6	-	-	-	-	-	-	-	-	36
40	-	37.2	-	29.9	-	25.0	-	19.4	-	-	-	-	-	-	40
48	-	28.7	-	27.1	-	24.7	-	20.1	-	14.2	-	9.2	-	-	48
56	-	22.6	-	21.1	-	20.7	-	18.5	-	14.7	-	10.3	-	6.1	56
64	-	17.8	-	16.7	-	16.2	-	14.4	-	12.4	-	9.9	-	6.5	64
72	-	14.2	-	13.1	-	12.9	-	11.1	-	9.3	-	7.3	-	5.1	72
80	-	11.0	-	10.2	-	10.2	-	8.4	-	6.7	-	4.7	-	-	80
88	-	8.5	-	7.7	-	7.7	-	6.3	-	4.4	-	-	-	-	88
96	-	6.5	-	5.6	-	5.6	-	4.5	-	2.7	-	-	-	-	96
104	-	4.8	-	4.1	-	4.1	-	2.8	-	-	-	-	-	-	104
112	-	3.5	-	-	-	-	-	-	-	-	-	-	-	-	112
1)	-	-	-	-	-	-	-	-	-	-	-	-	-	-	1)

1) Capacities with horizontal boom

* Max. values are valid only for specific superstructure positions

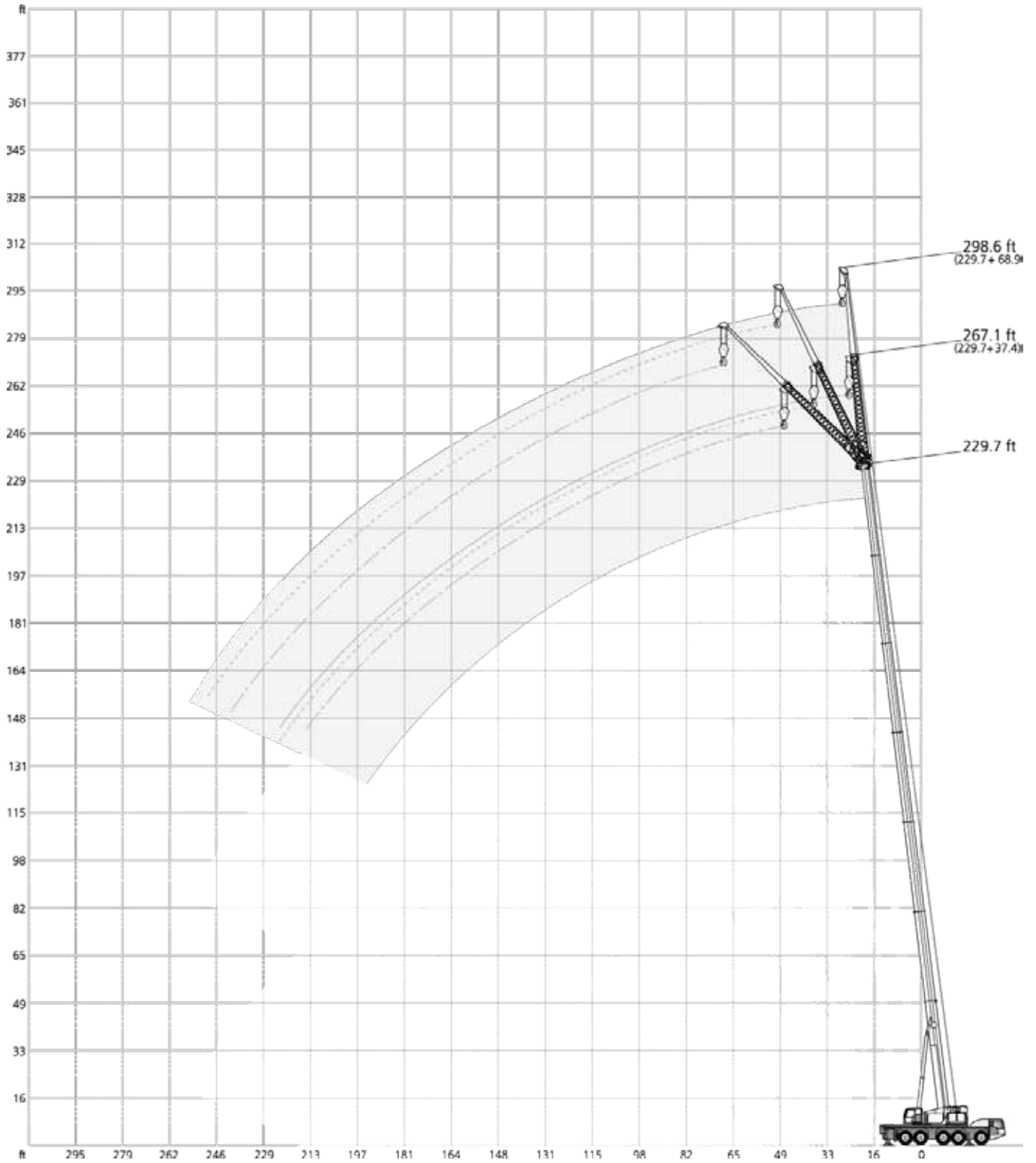
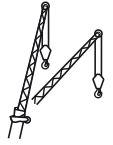

154,800 lb		27.60 ft x 29.10 ft						360°			85%								
41.7 ft										125.3 ft									
ft	37.4 ft			68.9 ft			ft	37.4 ft			68.9 ft								
	0°	20°	40°	0°	20°	40°		0°	20°	40°	0°	20°	40°						
1,000 lb													1,000 lb						
10	41.2	-	-	-	-	-	28	41.2	-	-	-	-	-						
12	41.2	-	-	23.3	-	-	32	41.2	-	-	19.0	-	-						
14	41.2	-	-	23.0	-	-	36	41.2	-	-	18.6	-	-						
16	41.2	-	-	22.8	-	-	40	41.2	30.7	-	18.3	-	-						
18	41.2	-	-	22.4	-	-	48	40.9	28.6	21.8	17.6	-	-						
20	41.2	35.0	-	22.0	-	-	56	38.8	26.9	21.0	17.0	13.1	-						
24	41.2	32.2	-	21.4	-	-	64	35.3	25.4	20.4	16.3	12.3	-						
28	39.8	29.9	-	20.5	-	-	72	32.3	24.1	19.9	15.7	11.7	-						
32	36.3	27.8	22.7	19.4	-	-	80	29.9	22.8	19.3	15.0	11.2	9.0						
36	33.1	26.1	21.7	18.2	-	-	88	27.8	21.8	18.9	14.1	10.6	8.7						
40	30.3	24.5	20.8	17.0	13.6	-	96	25.9	20.8	18.5	13.3	10.2	8.6						
48	26.1	21.9	19.3	14.9	12.3	-	104	24.2	20.1	18.3	12.4	9.8	8.4						
56	22.6	20.0	18.6	13.2	11.2	-	112	22.9	19.4	18.3	11.6	9.5	8.2						
64	20.1	18.9	-	11.9	10.3	9.1	120	21.6	18.8	18.3	10.9	9.1	8.1						
72	-	-	-	10.6	9.5	8.6	128	20.5	18.4	18.1	10.4	8.7	7.9						
80	-	-	-	9.8	9.0	8.3	136	19.7	18.3	9.4	10.0	8.4	7.9						
88	-	-	-	9.1	8.5	8.2	144	19.0	18.3	-	9.5	8.4	7.9						
96	-	-	-	8.5	8.2	-	152	7.9	7.9	-	9.0	8.2	7.9						
							160	-	-	-	8.7	8.2	6.7						
							168	-	-	-	8.5	8.2	-						
							176	-	-	-	8.4	8.2	-						
							184	-	-	-	5.2	-	-						

166.3 ft						
ft	37.4 ft			68.9 ft		
	0°	20°	40°	0°	20°	40°
1,000 lb						
40	39.2	-	-	16.5	-	-
48	38.2	-	-	16.0	-	-
56	36.9	27.3	-	15.6	-	-
64	35.2	26.0	20.6	15.3	-	-
72	33.1	24.7	20.1	14.8	12.1	-
80	31.5	23.6	19.5	14.3	11.6	-
88	29.7	22.7	19.1	13.9	11.1	8.9
96	28.0	21.8	18.8	13.5	10.7	8.7
104	26.2	21.0	18.4	13.1	10.2	8.6
112	24.3	20.3	18.1	12.8	9.9	8.4
120	22.3	19.7	18.0	12.2	9.6	8.2
128	20.3	19.2	17.7	11.7	9.4	8.2
136	18.3	18.5	17.3	11.1	9.1	8.0
144	16.8	17.0	16.4	10.6	8.8	7.9
152	15.5	15.7	15.3	10.3	8.6	7.9
160	14.4	14.4	14.4	9.8	8.4	7.9
168	13.3	13.4	-	9.5	8.2	7.9
176	12.1	12.5	-	9.1	8.2	7.9
184	10.9	11.2	-	8.8	8.0	7.9
192	-	-	-	8.6	7.9	-
200	-	-	-	8.4	7.9	-
208	-	-	-	8.0	7.9	-
216	-	-	-	7.3	7.7	-

229.7 ft						
ft	37.4 ft			68.9 ft		
	0°	20°	40°	0°	20°*	40°*
1,000 lb						
72	18.5	-	-	10.8	-	-
80	18.4	-	-	10.8	-	-
88	18.0	17.6	-	10.6	-	-
96	17.4	16.8	16.3	10.6	-	-
104	16.6	16.0	15.5	10.4	10.2	-
112	16.0	15.2	14.7	10.3	9.9	8.2
120	14.9	14.4	14.2	10.1	9.6	8.2
128	13.6	13.7	13.6	10.0	9.4	8.0
136	12.2	12.4	12.6	9.8	9.1	7.9
144	10.9	11.3	11.5	9.3	8.8	7.9
152	9.8	10.2	10.4	8.7	8.7	7.7
160	8.8	9.2	9.4	8.2	8.3	7.7
168	7.9	8.4	8.4	7.7	8.0	7.6
176	7.0	7.4	7.4	7.1	7.8	7.5
184	6.1	6.6	6.6	6.4	7.3	7.2
192	5.4	5.8	5.8	5.6	6.7	6.7
200	4.7	5.0	5.0	4.8	6.2	6.3
208	4.1	4.2	4.2	4.1	5.6	5.9
216	3.6	3.6	3.6	3.6	5.1	5.3
224	3.0	3.0	-	3.0	4.7	4.8
232	-	-	-	-	4.3	4.3
240	-	-	-	-	3.9	3.9
248	-	-	-	-	3.5	-

 *225.7 ft

113,800 lb		27.60 ft x 29.10 ft		360°			85%			
41.7 ft										
ft	37.4 ft			68.9 ft			ft	125.3 ft		
	0°	20°	40°	0°	20°	40°		0°	20°	40°
1,000 lb										
10	41.2	-	-	-	-	-	28	41.2	-	-
12	41.2	-	-	23.3	-	-	32	41.2	-	-
14	41.2	-	-	23.0	-	-	36	41.2	-	-
16	41.2	-	-	22.8	-	-	40	41.2	30.7	-
18	41.2	-	-	22.4	-	-	48	40.9	28.6	21.8
20	41.2	35.0	-	22.0	-	-	56	38.8	26.9	21.0
24	41.2	32.2	-	21.4	-	-	64	35.3	25.4	20.4
28	39.8	29.9	-	20.5	-	-	72	32.3	24.1	19.9
32	36.3	27.8	22.7	19.4	-	-	80	29.9	22.8	19.3
36	33.1	26.1	21.7	18.2	-	-	88	27.8	21.8	18.9
40	30.3	24.5	20.8	17.0	13.6	-	96	25.9	20.8	18.5
48	26.1	21.9	19.3	14.9	12.3	-	104	24.2	20.1	18.3
56	22.6	20.0	18.6	13.2	11.2	-	112	22.9	19.4	18.3
64	20.1	18.9	-	11.9	10.3	9.1	120	21.5	18.8	18.3
72	-	-	-	10.6	9.5	8.6	128	19.9	18.4	18.1
80	-	-	-	9.8	9.0	8.3	136	17.7	17.9	9.4
88	-	-	-	9.1	8.5	8.2	144	15.7	16.2	-
96	-	-	-	8.5	8.2	-	152	7.9	7.9	-
							160	-	-	-
							168	-	-	-
							176	-	-	-
							184	-	-	-

166.3 ft										
ft	37.4 ft			68.9 ft			ft	229.7 ft		
	0°	20°	40°	0°	20°	40°		0°	20°*	40°*
1,000 lb										
40	39.2	-	-	16.5	-	-	72	18.5	-	-
48	38.2	-	-	16.0	-	-	80	18.4	-	-
56	36.9	27.3	-	15.6	-	-	88	18.0	17.6	-
64	35.2	26.0	20.6	15.3	-	-	96	17.4	16.8	16.3
72	33.1	24.7	20.1	14.8	12.1	-	104	16.6	16.0	15.5
80	31.5	23.6	19.5	14.3	11.6	-	112	16.0	15.2	14.7
88	29.7	22.7	19.1	13.9	11.1	8.9	120	14.9	14.4	14.2
96	28.0	21.8	18.8	13.5	10.7	8.7	128	13.6	13.7	13.6
104	24.9	21.0	18.4	13.1	10.2	8.6	136	12.2	12.4	12.6
112	22.7	20.3	18.1	12.8	9.9	8.4	144	10.9	11.3	11.5
120	19.6	19.4	18.0	12.2	9.6	8.2	152	9.8	10.2	10.4
128	17.4	18.1	17.7	11.7	9.4	8.2	160	8.7	9.2	9.4
136	16.0	16.1	16.5	11.1	9.1	8.0	168	8.7	9.2	9.4
144	14.6	14.8	15.0	10.6	8.8	7.9	176	7.5	8.2	8.4
152	13.1	13.7	13.9	10.3	8.6	7.9	184	6.1	7.0	7.4
160	12.2	12.1	12.4	9.8	8.4	7.9	192	5.0	5.8	6.2
168	11.4	11.4	-	9.3	8.2	7.9	200	4.0	4.6	5.1
176	10.3	10.7	-	9.1	8.2	7.9	208	3.0	3.7	4.0
184	9.2	8.2	-	8.3	8.0	7.9	216	-	-	-
192	-	-	-	7.9	7.7	-				
200	-	-	-	7.4	7.4	-				
208	-	-	-	6.8	6.9	-				
216	-	-	-	6.0	6.2	-				

229.7 ft										
ft	37.4 ft			68.9 ft			ft	225.7 ft		
	0°	20°	40°	0°	20°*	40°*		0°	20°*	40°*
1,000 lb										
72	18.5	-	-	10.8	-	-				
80	18.4	-	-	10.8	-	-				
88	18.0	17.6	-	10.6	-	-				
96	17.4	16.8	16.3	10.6	-	-				
104	16.6	16.0	15.5	10.4	10.2	-				
112	16.0	15.2	14.7	10.3	9.9	8.2				
120	14.9	14.4	14.2	10.1	9.6	8.2				
128	13.6	13.7	13.6	10.0	9.4	8.0				
136	12.2	12.4	12.6	9.8	9.1	7.9				
144	10.9	11.3	11.5	9.3	8.8	7.9				
152	9.8	10.2	10.4	8.7	8.7	7.7				
160	8.7	9.2	9.4	8.2	8.3	7.7				
168	7.5	8.2	8.4	7.5	8.0	7.6				
176	6.1	7.0	7.4	6.5	7.8	7.5				
184	5.0	5.8	6.2	5.4	6.9	7.2				
192	4.0	4.6	5.1	4.2	6.0	6.7				
200	3.0	3.7	4.0	3.3	5.0	5.9				
208	-	-	-	-	4.1	4.9				
216	-	-	-	-	3.1	3.8				

 *225.7 ft

41,200 lb								27.60 ft x 29.10 ft								360°			85%		
41.7 ft								125.3 ft													
ft	37.4 ft			68.9 ft			ft	37.4 ft			68.9 ft			ft	37.4 ft		68.9 ft				
	0°	20°	40°	0°	20°	40°		0°	20°	40°	0°	20°	40°		0°	20°	40°				
1,000 lb																					
10	41.2	-	-	-	-	-	28	41.2	-	-	-	-	-	-	-	-					
12	41.2	-	-	23.3	-	-	32	41.2	-	-	19.0	-	-	-	-	-					
14	41.2	-	-	23.0	-	-	36	41.2	-	-	18.6	-	-	-	-	-					
16	41.2	-	-	22.8	-	-	40	41.2	30.7	-	18.3	-	-	-	-	-					
18	41.2	-	-	22.4	-	-	48	40.9	28.6	21.8	17.6	-	-	-	-	-					
20	41.2	35.0	-	22.0	-	-	56	38.2	26.9	21.0	17.0	13.1	-	-	-	-					
24	41.2	32.2	-	21.4	-	-	64	33.3	25.4	20.4	16.3	12.3	-	-	-	-					
28	39.8	29.9	-	20.5	-	-	72	27.5	24.1	19.9	15.7	11.7	-	-	-	-					
32	36.3	27.8	22.7	19.4	-	-	80	23.4	22.3	19.3	15.0	11.2	9.0	-	-	-					
36	33.1	26.1	21.7	18.2	-	-	88	19.8	20.3	18.8	14.1	10.6	8.7	-	-	-					
40	30.3	24.5	20.8	17.0	13.6	-	96	16.9	17.9	17.9	13.3	10.2	8.6	-	-	-					
48	26.1	21.9	19.3	14.9	12.3	-	104	15.2	15.1	15.8	12.2	9.8	8.4	-	-	-					
56	22.6	20.0	18.6	13.2	11.2	-	112	12.9	14.0	13.8	11.4	9.5	8.2	-	-	-					
64	20.1	18.9	-	11.9	10.3	9.1	120	11.1	11.9	12.3	10.7	9.0	8.1	-	-	-					
72	-	-	-	10.6	9.5	8.6	128	9.5	10.1	10.2	9.9	8.7	7.9	-	-	-					
80	-	-	-	9.8	9.0	8.3	136	8.0	8.5	8.7	8.5	8.4	7.9	-	-	-					
88	-	-	-	9.1	8.5	8.2	144	6.9	7.1	-	7.3	8.4	7.9	-	-	-					
96	-	-	-	8.5	8.2	-	152	5.6	6.0	-	6.2	7.1	7.8	-	-	-					
							160	-	-	-	5.3	6.1	6.5	-	-	-					
							168	-	-	-	4.5	5.0	-	-	-	-					
							176	-	-	-	3.6	4.1	-	-	-	-					
							184	-	-	-	2.7	-	-	-	-	-					

166.3 ft													
ft	37.4 ft			68.9 ft			ft	37.4 ft		68.9 ft			
	0°	20°	40°	0°	20°	40°		0°	20°	40°			
1,000 lb													
40	39.2	-	-	16.5	-	-	72	18.1	-	-	10.8	-	-
48	37.4	-	-	16.0	-	-	80	14.0	-	-	10.7	-	-
56	34.6	27.3	-	15.6	-	-	88	10.7	13.5	-	9.5	-	-
64	29.5	26.0	20.6	15.3	-	-	96	8.0	10.5	12.7	6.9	-	-
72	25.0	24.3	20.1	14.8	12.1	-	104	5.8	8.0	10.0	4.9	9.1	-
80	21.9	22.3	19.5	14.2	11.6	-	112	3.9	5.8	7.6	-	6.9	8.2
88	18.4	19.3	18.9	13.6	11.1	8.9	120	-	4.0	5.6	-	5.1	7.8
96	16.1	16.7	17.3	12.9	10.7	8.7	128	-	-	4.0	-	3.6	6.4
104	13.3	14.7	14.9	12.0	10.2	8.6	136	-	-	-	-	-	4.8
112	11.1	12.4	13.3	10.9	9.7	8.4	144	-	-	-	-	-	3.4
120	9.1	10.4	11.2	9.3	9.4	8.2							
128	7.5	8.6	9.1	7.8	8.9	8.0							
136	6.0	7.0	7.6	6.5	8.2	7.9							
144	4.9	5.6	6.0	5.1	6.7	7.9							
152	3.6	4.4	4.7	4.0	5.6	6.7							
160	2.7	3.3	3.6	3.1	4.3	5.3							
168	-	-	-	-	3.3	4.1							
176	-	-	-	-	2.3	3.0							





229.7 ft													
ft	37.4 ft			68.9 ft			ft	37.4 ft		68.9 ft			
	0°	20°	40°	0°	20°	40°		0°	20°*	40°*			
1,000 lb													
72	18.1	-	-	10.8	-	-							
80	14.0	-	-	10.7	-	-							
88	10.7	13.5	-	9.5	-	-							
96	8.0	10.5	12.7	6.9	-	-							
104	5.8	8.0	10.0	4.9	9.1	-							
112	3.9	5.8	7.6	-	6.9	8.2							
120	-	4.0	5.6	-	5.1	7.8							
128	-	-	4.0	-	3.6	6.4							
136	-	-	-	-	-	4.8							
144	-	-	-	-	-	3.4							



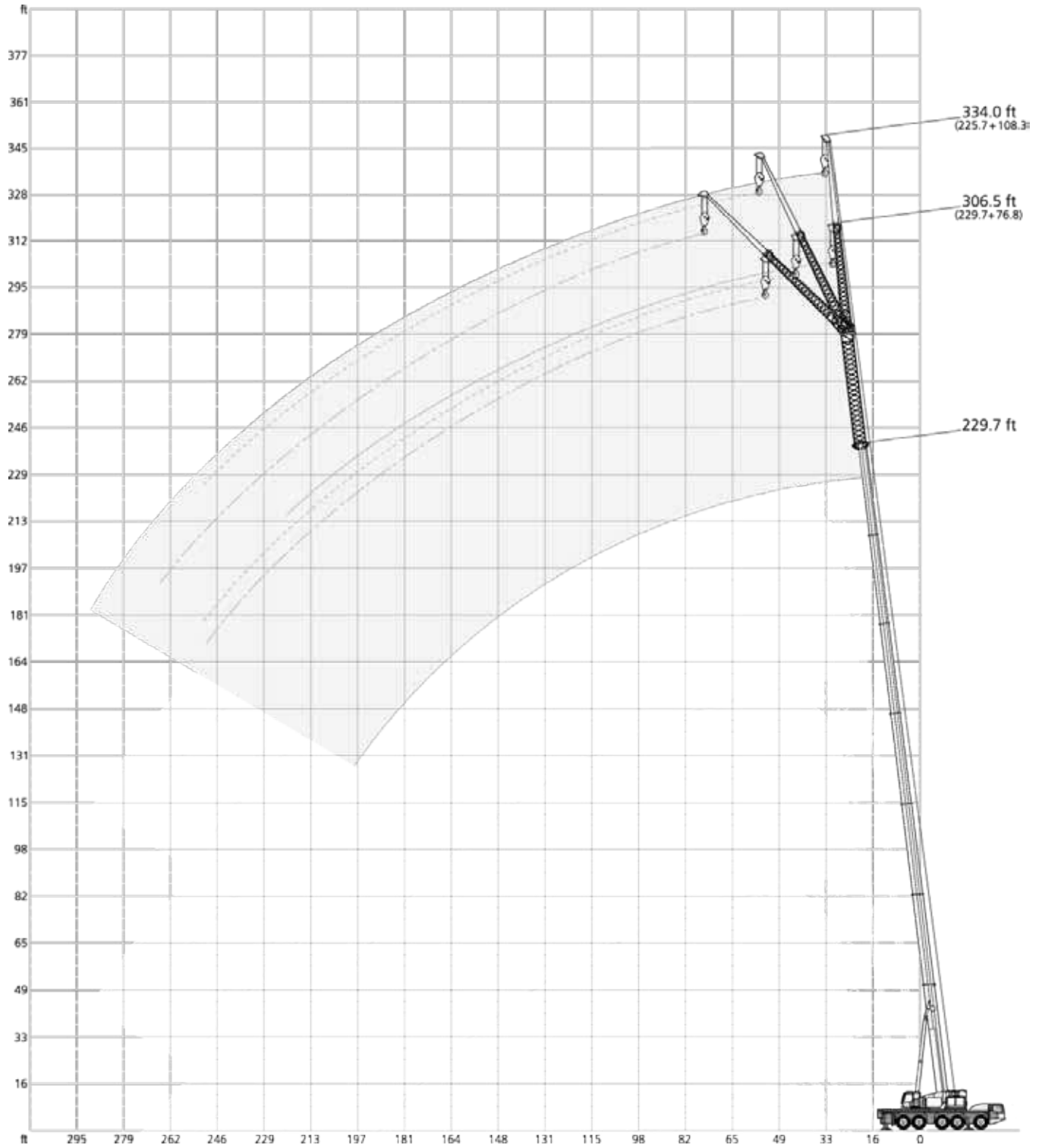
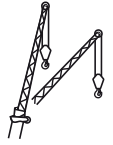

 *225.7 ft





HAV-VA

AC 250-5











154,800 lb		27.60 ft x 29.10 ft		360°			85%			
 41.7 ft										
  76.8 ft										
 108.3 ft										
ft	0°	20°	40°	0°	20°	40°	ft	0°	20°	40°
1,000 lb										
16	40.7	-	-	-	-	-	40	27.6	-	-
18	39.0	-	-	-	-	-	48	25.5	-	-
20	37.0	-	-	18.3	-	-	56	23.4	20.1	-
24	33.6	-	-	17.9	-	-	64	21.5	18.6	16.8
28	30.5	-	-	17.5	-	-	72	19.9	17.4	15.9
32	28.0	24.9	-	17.3	-	-	80	18.5	16.4	15.1
36	25.9	23.2	-	16.9	-	-	88	17.2	15.4	14.3
40	24.0	21.6	19.9	16.4	-	-	96	16.0	14.4	13.6
48	20.5	19.0	17.8	15.0	13.2	-	104	14.9	13.7	12.9
56	18.0	16.8	16.0	13.6	12.3	-	112	14.1	13.0	12.3
64	16.0	15.1	14.6	12.4	11.4	-	120	13.3	12.4	11.7
72	14.4	13.7	13.3	11.3	10.6	9.1	128	12.7	11.9	11.0
80	13.1	12.6	12.4	10.2	9.8	8.8	136	12.0	11.4	10.5
88	12.0	11.6	11.5	9.2	9.0	8.4	144	11.5	10.8	9.9
96	11.0	10.8	-	8.4	8.2	7.9	152	11.0	10.5	9.2
104	10.2	10.2	-	7.8	7.6	7.3	160	10.4	10.1	8.6
112	-	-	-	7.0	7.0	7.0	168	10.1	9.7	-
120	-	-	-	6.7	6.6	-	176	9.9	9.3	-
128	-	-	-	6.3	6.3	-	184	9.3	4.4	-
136	-	-	-	6.0	-	-	192	-	-	-
							200	-	-	-
							208	-	-	-
							216	-	-	-





 166.3 ft										
  76.8 ft										
 108.3 ft										
ft	0°	20°	40°	0°	20°	40°	ft	0°	20°	40°
1,000 lb										
56	21.8	-	-	12.3	-	-	80	11.2	-	-
64	20.7	-	-	12.2	-	-	88	10.9	-	-
72	19.4	17.2	-	11.9	-	-	96	10.7	10.8	8.2
80	18.4	16.4	13.6	11.6	-	-	104	10.4	10.6	8.2
88	17.5	15.6	13.0	11.1	10.2	-	112	10.1	10.3	7.9
96	16.6	14.8	12.4	10.7	9.6	-	120	9.9	10.0	7.7
104	15.8	14.2	11.8	10.2	9.1	7.1	128	9.6	9.5	7.5
112	14.9	13.4	11.4	9.7	8.8	6.8	136	9.2	9.1	7.3
120	14.1	12.9	10.9	9.2	8.3	6.6	144	8.6	8.6	7.1
128	13.4	12.3	10.4	8.8	8.0	6.4	152	8.1	8.1	7.0
136	12.7	11.8	10.0	8.4	7.6	6.2	160	7.5	7.8	6.7
144	12.1	11.5	9.5	8.0	7.3	6.0	168	7.0	7.3	6.5
152	11.8	11.0	9.2	7.7	7.0	5.7	176	6.5	6.9	6.4
160	11.3	10.6	8.7	7.4	6.7	5.4	184	5.7	6.4	6.3
168	10.8	10.2	8.5	7.1	6.5	5.2	192	4.9	5.9	6.1
176	10.2	10.0	8.2	6.7	6.2	5.1	200	4.3	5.5	5.5
184	9.7	9.6	7.8	6.4	6.1	4.8	208	3.6	5.0	5.1
192	9.1	9.2	7.4	6.1	5.9	4.6	216	2.9	4.4	4.7
200	8.6	8.8	7.2	6.0	5.8	4.5	224	-	4.0	4.1
208	7.8	8.1	-	5.8	5.7	4.3	232	-	3.6	3.6
216	6.9	7.3	-	5.5	5.5	4.2	240	-	3.1	3.2
224	6.0	6.3	-	5.4	5.3	4.1	248	-	2.6	2.7
232	-	-	-	5.1	5.0	-	256	-	-	-
240	-	-	-	4.6	4.9	-	264	-	-	-
248	-	-	-	4.1	4.4	-				

 229.7 ft										
  76.8 ft										
 108.3 ft										
ft	0°	20°*	40°*	0°*	20°**	40°**	ft	0°	20°	40°
1,000 lb										
80	11.2	-	-	6.8	-	-	112	10.1	10.3	7.9
88	10.9	-	-	6.8	-	-	120	9.9	10.0	7.7
96	10.7	10.8	8.2	6.8	-	-	128	9.6	9.5	7.5
104	10.4	10.6	8.2	6.8	-	-	136	9.2	9.1	7.3
112	10.1	10.3	7.9	6.8	7.9	4.8	144	8.6	8.6	7.1
120	9.9	10.0	7.7	6.6	7.7	4.6	152	8.1	8.1	7.0
128	9.6	9.5	7.5	6.4	7.4	4.5	160	7.5	7.8	6.7
136	9.2	9.1	7.3	6.2	7.1	4.4	168	7.0	7.3	6.5
144	8.6	8.6	7.1	6.0	6.8	4.2	176	6.5	6.9	6.4
152	8.1	8.1	7.0	5.9	6.6	4.2	184	5.7	6.4	6.3
160	7.5	7.8	6.7	5.6	6.4	4.0	192	4.9	5.9	6.1
168	7.0	7.3	6.5	5.4	6.3	3.9	200	4.3	5.5	5.5
176	6.5	6.9	6.4	5.1	6.0	3.8	208	3.6	5.0	5.1
184	5.7	6.4	6.3	4.8	5.8	3.6	216	2.9	4.4	4.7
192	4.9	5.9	6.1	4.6	5.7	3.5	224	-	4.0	4.1
200	4.3	5.5	5.5	4.3	5.4	3.4	232	-	3.6	3.6
208	3.6	5.0	5.1	4.0	5.1	3.2	240	-	3.1	3.2
216	2.9	4.4	4.7	3.6	4.9	3.1	248	-	2.6	2.7
224	-	4.0	4.1	3.2	4.6	3.1	256	-	-	-
232	-	3.6	3.6	2.8	4.3	3.0	264	-	-	-
240	-	3.1	3.2	2.5	4.1	2.9				
248	-	2.6	2.7	-	3.7	2.9				
256	-	-	-	-	-	2.9				
264	-	-	-	-	-	2.5				

 *225.7 ft **209.0 ft

113,800 lb		27.60 ft x 29.10 ft		360°			85%			
 41.7 ft										
  76.8 ft										
 108.3 ft										
ft	0°	20°	40°	0°	20°	40°	ft	0°	20°	40°
1,000 lb										
16	40.7	-	-	-	-	-	40	27.6	-	-
18	39.0	-	-	-	-	-	48	25.5	-	-
20	37.0	-	-	18.3	-	-	56	23.4	20.1	-
24	33.6	-	-	17.9	-	-	64	21.5	18.6	16.8
28	30.5	-	-	17.5	-	-	72	19.9	17.4	15.9
32	28.0	24.9	-	17.3	-	-	80	18.5	16.4	15.1
36	25.9	23.2	-	16.9	-	-	88	17.2	15.4	14.3
40	24.0	21.6	19.9	16.4	-	-	96	16.0	14.4	13.6
48	20.5	19.0	17.8	15.0	13.2	-	104	14.9	13.7	12.9
56	18.0	16.8	16.0	13.6	12.3	-	112	14.1	13.0	12.3
64	16.0	15.1	14.6	12.4	11.4	-	120	13.3	12.4	11.7
72	14.4	13.7	13.3	11.3	10.6	9.1	128	12.7	11.9	11.0
80	13.1	12.6	12.4	10.2	9.8	8.8	136	12.0	11.4	10.5
88	12.0	11.6	11.5	9.2	9.0	8.4	144	11.5	10.8	9.9
96	11.0	10.8	-	8.4	8.2	7.9	152	11.0	10.5	9.2
104	10.2	10.2	-	7.8	7.6	7.3	160	10.4	10.1	8.6
112	-	-	-	7.0	7.0	7.0	168	10.0	9.7	-
120	-	-	-	6.7	6.6	-	176	9.7	9.3	-
128	-	-	-	6.3	6.3	-	184	9.1	4.4	-
136	-	-	-	6.0	-	-	192	-	-	-
							200	-	-	-
							208	-	-	-
							216	-	-	-

 166.3 ft										
  76.8 ft										
 108.3 ft										
ft	0°	20°	40°	0°	20°	40°	ft	0°	20°	40°
1,000 lb										
56	21.8	-	-	12.3	-	-	80	11.2	-	-
64	20.7	-	-	12.2	-	-	88	10.9	-	-
72	19.4	17.2	-	11.9	-	-	96	10.7	10.8	8.2
80	18.4	16.4	13.6	11.6	-	-	104	10.4	10.6	8.2
88	17.5	15.6	13.0	11.1	10.2	-	112	10.1	10.3	7.9
96	16.6	14.8	12.4	10.7	9.6	-	120	9.9	10.0	7.7
104	15.8	14.2	11.8	10.2	9.1	7.1	128	9.6	9.5	7.5
112	14.9	13.4	11.4	9.7	8.8	6.8	136	9.2	9.1	7.3
120	14.1	12.9	10.9	9.2	8.3	6.6	144	8.6	8.6	7.1
128	13.4	12.3	10.4	8.8	8.0	6.4	152	8.1	8.1	7.0
136	12.7	11.8	10.0	8.4	7.6	6.2	160	7.5	7.8	6.7
144	12.1	11.5	9.5	8.0	7.3	6.0	168	6.9	7.3	6.5
152	11.5	11.0	9.2	7.7	7.0	5.7	176	6.1	6.9	6.4
160	10.4	10.4	8.7	7.4	6.7	5.4	184	5.0	6.0	6.2
168	9.7	9.5	8.4	7.1	6.5	5.2	192	4.0	5.1	5.7
176	8.9	9.1	8.0	6.7	6.2	5.1	200	3.0	4.1	4.6
184	7.9	8.2	7.7	6.4	6.1	4.8	208	-	-	3.6
192	6.9	7.3	7.3	6.1	5.9	4.6	216	-	-	2.7
200	6.5	6.5	6.6	5.7	5.6	4.5	224	-	-	-
208	6.0	6.2	-	5.0	5.4	4.3				
216	5.3	5.8	-	4.4	5.1	4.2				
224	4.7	3.9	-	4.1	4.3	4.1				
232	-	-	-	3.8	3.9	-				
240	-	-	-	3.3	3.8	-				
248	-	-	-	2.8	3.3	-				

 229.7 ft										
  76.8 ft										
 108.3 ft										
ft	0°	20°*	40°*	0°*	20°**	40°**	ft	0°	20°	40°
1,000 lb										
80	11.2	-	-	6.8	-	-	80	11.2	-	-
88	10.9	-	-	6.8	-	-	88	10.9	-	-
96	10.7	10.8	8.2	6.8	-	-	96	10.7	10.8	8.2
104	10.4	10.6	8.2	6.8	-	-	104	10.4	10.6	8.2
112	10.1	10.3	7.9	6.8	7.9	4.8	112	10.1	10.3	7.9
120	9.9	10.0	7.7	6.6	7.7	4.6	120	9.9	10.0	7.7
128	9.6	9.5	7.5	6.4	7.4	4.5	128	9.6	9.5	7.5
136	9.2	9.1	7.3	6.2	7.1	4.4	136	9.2	9.1	7.3
144	8.6	8.6	7.1	6.0	6.8	4.2	144	8.6	8.6	7.1
152	8.1	8.1	7.0	5.9	6.6	4.2	152	8.1	8.1	7.0
160	7.5	7.8	6.7	5.6	6.4	4.0	160	7.5	7.8	6.7
168	6.9	7.3	6.5	5.4	6.3	3.9	168	6.9	7.3	6.5
176	6.1	6.9	6.4	5.1	6.0	3.8	176	6.1	6.9	6.4
184	5.0	6.0	6.2	4.5	5.8	3.6	184	5.0	6.0	6.2
192	4.0	5.1	5.7	3.8	5.6	3.5	192	4.0	5.1	5.7
200	3.0	4.1	4.6	3.0	4.9	3.4	200	3.0	4.1	4.6
208	-	-	3.6	-	4.1	3.2	208	-	-	3.6
216	-	-	2.7	-	3.1	3.1	216	-	-	2.7
224	-	-	-	-	-	2.7	224	-	-	-

 *225.7 ft **209.0 ft

41,200 lb										27.60 ft x 29.10 ft						360°			85%		
41.7 ft										125.3 ft											
76.8 ft										108.3 ft											
0° 20° 40°										0° 20° 40°											
ft										ft											
1,000 lb										1,000 lb											
16	40.7	-	-	-	-	-	-	-	-	40	27.6	-	-	-	14.7	-	-	-	-		
18	39.0	-	-	-	-	-	-	-	-	48	25.5	-	-	-	14.3	-	-	-	-		
20	37.0	-	-	-	18.3	-	-	-	-	56	23.4	20.1	-	-	13.9	-	-	-	-		
24	33.6	-	-	-	17.9	-	-	-	-	64	21.5	18.6	16.8	-	13.3	-	-	-	-		
28	30.5	-	-	-	17.5	-	-	-	-	72	19.9	17.4	15.9	-	12.8	11.7	-	-	-		
32	28.0	24.9	-	-	17.3	-	-	-	-	80	18.5	16.4	15.1	-	12.2	10.9	-	-	-		
36	25.9	23.2	-	-	16.9	-	-	-	-	88	17.0	15.4	14.3	-	11.5	10.4	8.9	-	-		
40	24.0	21.6	19.9	-	16.4	-	-	-	-	96	15.8	14.4	13.6	-	10.8	9.7	8.7	-	-		
48	20.5	19.0	17.8	-	15.0	13.2	-	-	-	104	14.2	13.5	12.9	-	10.2	9.3	8.4	-	-		
56	18.0	16.8	16.0	-	13.6	12.3	-	-	-	112	12.2	12.7	12.3	-	9.6	8.8	7.9	-	-		
64	16.0	15.1	14.6	-	12.4	11.4	-	-	-	120	10.2	11.2	11.3	-	8.9	8.3	7.7	-	-		
72	14.4	13.7	13.3	-	11.3	10.6	9.1	-	-	128	9.4	9.5	10.1	-	8.4	7.8	7.4	-	-		
80	13.1	12.6	12.4	-	10.2	9.8	8.8	-	-	136	8.2	8.7	8.7	-	7.4	7.4	7.1	-	-		
88	12.0	11.6	11.5	-	9.2	9.0	8.4	-	-	144	6.9	7.6	8.0	-	6.9	7.1	6.8	-	-		
96	11.0	10.8	-	-	8.4	8.2	7.9	-	-	152	5.8	6.4	6.7	-	6.0	6.3	6.5	-	-		
104	10.2	10.2	-	-	7.8	7.6	7.3	-	-	160	4.8	5.3	5.5	-	5.0	5.8	5.9	-	-		
112	-	-	-	-	7.0	7.0	7.0	-	-	168	4.0	4.4	-	-	4.0	5.0	5.3	-	-		
120	-	-	-	-	6.7	6.6	-	-	-	176	3.2	3.4	-	-	3.2	4.1	4.7	-	-		
128	-	-	-	-	6.3	6.3	-	-	-	184	-	-	-	-	-	3.3	3.8	-	-		
136	-	-	-	-	6.0	-	-	-	-												

166.3 ft										229.7 ft									
76.8 ft										108.3 ft									
0° 20° 40°										0° 20° 40°									
ft										ft									
1,000 lb										1,000 lb									
56	21.8	-	-	-	12.3	-	-	-	-	80	11.0	-	-	-	6.8	-	-	-	-
64	20.7	-	-	-	12.2	-	-	-	-	88	9.1	-	-	-	6.7	-	-	-	-
72	19.4	17.2	-	-	11.9	-	-	-	-	96	6.6	9.6	8.2	-	5.5	-	-	-	-
80	17.6	16.4	13.6	-	11.6	-	-	-	-	104	4.5	7.1	8.2	-	3.5	-	-	-	-
88	16.0	15.2	13.0	-	10.9	10.2	-	-	-	112	-	5.2	6.9	-	-	6.5	4.8	-	-
96	14.0	14.2	12.4	-	10.3	9.6	-	-	-	120	-	3.4	5.1	-	-	4.7	4.6	-	-
104	11.6	13.1	11.8	-	9.5	9.1	7.1	-	-	128	-	-	3.5	-	-	3.2	4.5	-	-
112	10.5	11.1	10.9	-	8.5	8.6	6.8	-	-	136	-	-	-	-	-	-	4.1	-	-
120	8.9	9.7	10.1	-	7.6	8.0	6.6	-	-	144	-	-	-	-	-	-	-	2.9	-
128	7.4	8.5	9.0	-	6.3	7.5	6.4	-	-										
136	6.0	7.1	7.9	-	5.1	6.5	6.0	-	-										
144	4.9	5.8	6.5	-	4.0	5.1	5.7	-	-										
152	3.8	4.5	5.1	-	3.0	4.0	5.2	-	-										
160	2.7	3.4	4.1	-	-	3.1	4.5	-	-										
168	-	-	-	-	-	-	3.5	-	-										
176	-	-	-	-	-	-	2.6	-	-										

166.3 ft										229.7 ft									
76.8 ft										108.3 ft									
0° 20° 40°										0°* 20°** 40°**									
ft										ft									
1,000 lb										1,000 lb									
80	11.0	-	-	-	6.8	-	-	-	-	80	11.0	-	-	-	6.8	-	-	-	-
88	9.1	-	-	-	6.7	-	-	-	-	88	9.1	-	-	-	6.7	-	-	-	-
96	6.6	9.6	8.2	-	5.5	-	-	-	-	96	6.6	9.6	8.2	-	5.5	-	-	-	-
104	4.5	7.1	8.2	-	3.5	-	-	-	-	104	4.5	7.1	8.2	-	3.5	-	-	-	-
112	-	5.2	6.9	-	-	6.5	4.8	-	-	112	-	5.2	6.9	-	-	6.5	4.8	-	-
120	-	3.4	5.1	-	-	4.7	4.6	-	-	120	-	3.4	5.1	-	-	4.7	4.6	-	-
128	-	-	3.5	-	-	3.2	4.5	-	-	128	-	-	3.5	-	-	3.2	4.5	-	-
136	-	-	-	-	-	-	4.1	-	-	136	-	-	-	-	-	-	4.1	-	-
144	-	-	-	-	-	-	-	2.9	-	144	-	-	-	-	-	-	-	2.9	-

 *225.7 ft **209.0 ft

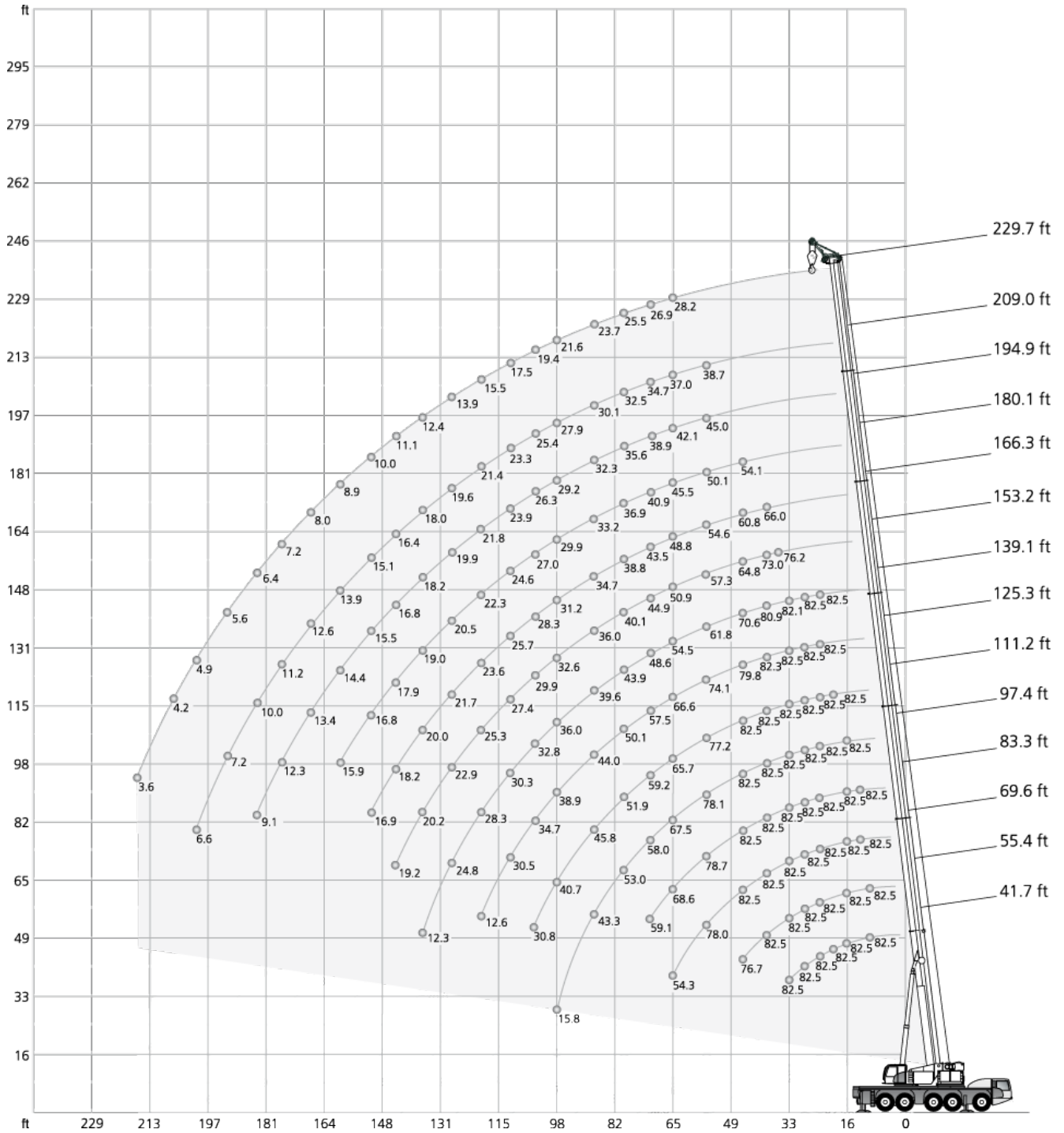

154,800 lb		27.60 ft x 29.10 ft												360°		85%												
41.7ft		55.4ft		69.6ft		83.3ft		97.4ft		111.2ft		125.3ft		139.1ft		153.2ft		166.3ft		180.1ft		194.9ft		209.0ft		229.7ft		
ft	1,000 lb																								ft			
10	82.5	82.5	82.5	-	-	-	-	-	-	-	-	-	-	-	-	-	-	-	-	-	-	-	-	-	-	-	-	10
12	82.5	82.5	82.5	-	-	-	-	-	-	-	-	-	-	-	-	-	-	-	-	-	-	-	-	-	-	-	-	12
14	82.5	82.5	82.5	82.5	-	-	-	-	-	-	-	-	-	-	-	-	-	-	-	-	-	-	-	-	-	-	-	14
16	82.5	82.5	82.5	82.5	82.5	-	-	-	-	-	-	-	-	-	-	-	-	-	-	-	-	-	-	-	-	-	-	16
18	82.5	82.5	82.5	82.5	82.5	82.5	-	-	-	-	-	-	-	-	-	-	-	-	-	-	-	-	-	-	-	-	-	18
20	82.5	82.5	82.5	82.5	82.5	82.5	82.5	-	-	-	-	-	-	-	-	-	-	-	-	-	-	-	-	-	-	-	-	20
24	82.5	82.5	82.5	82.5	82.5	82.5	82.5	82.5	-	-	-	-	-	-	-	-	-	-	-	-	-	-	-	-	-	-	-	24
28	82.5	82.5	82.5	82.5	82.5	82.5	82.5	82.5	82.5	-	-	-	-	-	-	-	-	-	-	-	-	-	-	-	-	-	-	28
32	82.5	82.5	82.5	82.5	82.5	82.5	82.5	82.5	82.5	82.5	-	-	-	-	-	-	-	-	-	-	-	-	-	-	-	-	-	32
36	-	82.5	82.5	82.5	82.5	82.5	82.5	82.5	82.1	76.2	-	-	-	-	-	-	-	-	-	-	-	-	-	-	-	-	-	36
40	-	82.5	82.5	82.5	82.5	82.5	82.5	82.3	80.9	73.0	66.0	-	-	-	-	-	-	-	-	-	-	-	-	-	-	-	-	40
48	-	76.7	82.5	82.5	82.5	82.5	82.5	79.8	70.6	64.8	60.8	54.1	-	-	-	-	-	-	-	-	-	-	-	-	-	-	-	48
56	-	-	78.0	78.7	78.1	77.2	74.1	61.8	57.3	54.6	50.1	45.0	38.7	-	-	-	-	-	-	-	-	-	-	-	-	-	-	56
64	-	-	54.3	68.6	67.5	65.7	66.6	54.5	50.9	48.8	45.5	42.1	37.0	28.2	-	-	-	-	-	-	-	-	-	-	-	-	-	64
72	-	-	-	59.1	58.0	59.2	57.5	48.6	44.9	43.5	40.9	38.9	34.7	26.9	72	-	-	-	-	-	-	-	-	-	-	-	-	72
80	-	-	-	-	53.0	51.9	50.1	43.9	40.1	38.8	36.9	35.6	32.5	25.5	80	-	-	-	-	-	-	-	-	-	-	-	-	80
88	-	-	-	-	43.3	45.8	44.0	39.6	36.0	34.7	33.2	32.3	30.1	23.7	88	-	-	-	-	-	-	-	-	-	-	-	-	88
96	-	-	-	-	15.8	40.7	38.9	36.0	32.6	31.2	29.9	29.2	27.9	21.6	96	-	-	-	-	-	-	-	-	-	-	-	-	96
104	-	-	-	-	-	30.8	34.7	32.8	29.9	28.3	27.0	26.3	25.4	19.4	104	-	-	-	-	-	-	-	-	-	-	-	-	104
112	-	-	-	-	-	-	30.5	30.3	27.4	25.7	24.6	23.9	23.3	17.5	112	-	-	-	-	-	-	-	-	-	-	-	-	112
120	-	-	-	-	-	-	12.6	28.3	25.3	23.6	22.3	21.8	21.4	15.5	120	-	-	-	-	-	-	-	-	-	-	-	-	120
128	-	-	-	-	-	-	-	24.8	22.9	21.7	20.5	19.9	19.6	13.9	128	-	-	-	-	-	-	-	-	-	-	-	-	128
136	-	-	-	-	-	-	-	12.3	20.2	20.0	19.0	18.2	18.0	12.4	136	-	-	-	-	-	-	-	-	-	-	-	-	136
144	-	-	-	-	-	-	-	-	19.2	18.2	17.9	16.8	16.4	11.1	144	-	-	-	-	-	-	-	-	-	-	-	-	144
152	-	-	-	-	-	-	-	-	-	16.9	16.8	15.5	15.1	10.0	152	-	-	-	-	-	-	-	-	-	-	-	-	152
160	-	-	-	-	-	-	-	-	-	-	15.9	14.4	13.9	8.9	160	-	-	-	-	-	-	-	-	-	-	-	-	160
168	-	-	-	-	-	-	-	-	-	-	-	13.4	12.6	8.0	168	-	-	-	-	-	-	-	-	-	-	-	-	168
176	-	-	-	-	-	-	-	-	-	-	-	12.3	11.2	7.2	176	-	-	-	-	-	-	-	-	-	-	-	-	176
184	-	-	-	-	-	-	-	-	-	-	-	9.1	10.0	6.4	184	-	-	-	-	-	-	-	-	-	-	-	-	184
192	-	-	-	-	-	-	-	-	-	-	-	-	7.2	5.6	192	-	-	-	-	-	-	-	-	-	-	-	-	192
200	-	-	-	-	-	-	-	-	-	-	-	-	6.6	4.9	200	-	-	-	-	-	-	-	-	-	-	-	-	200
208	-	-	-	-	-	-	-	-	-	-	-	-	-	4.2	208	-	-	-	-	-	-	-	-	-	-	-	-	208
216	-	-	-	-	-	-	-	-	-	-	-	-	-	3.6	216	-	-	-	-	-	-	-	-	-	-	-	-	216
1)	40.6	30.2	23.6	18.5	14.8	11.5	8.8	6.2	4.0	2.6	-	-	-	-	1)	-	-	-	-	-	-	-	-	-	-	-	-	1)

1) Capacities with horizontal boom

☰ 113,800 lb		📏 27.60 ft x 29.10 ft												360°		85%	
📐		41.7ft	55.4ft	69.6ft	83.3ft	97.4ft	111.2ft	125.3ft	139.1ft	153.2ft	166.3ft	180.1ft	194.9ft	209.0ft	229.7ft	📐	
ft	1,000 lb														ft		
10	82.5	82.5	82.5	-	-	-	-	-	-	-	-	-	-	-	-	-	10
12	82.5	82.5	82.5	-	-	-	-	-	-	-	-	-	-	-	-	-	12
14	82.5	82.5	82.5	82.5	-	-	-	-	-	-	-	-	-	-	-	-	14
16	82.5	82.5	82.5	82.5	82.5	-	-	-	-	-	-	-	-	-	-	-	16
18	82.5	82.5	82.5	82.5	82.5	82.5	-	-	-	-	-	-	-	-	-	-	18
20	82.5	82.5	82.5	82.5	82.5	82.5	82.5	-	-	-	-	-	-	-	-	-	20
24	82.5	82.5	82.5	82.5	82.5	82.5	82.5	82.5	-	-	-	-	-	-	-	-	24
28	82.5	82.5	82.5	82.5	82.5	82.5	82.5	82.5	82.5	-	-	-	-	-	-	-	28
32	82.5	82.5	82.5	82.5	82.5	82.5	82.5	82.5	82.5	-	-	-	-	-	-	-	32
36	-	82.5	82.5	82.5	82.5	82.5	82.5	82.5	82.1	76.2	-	-	-	-	-	-	36
40	-	82.5	82.5	82.5	82.5	82.5	82.5	82.3	80.9	73.0	66.0	-	-	-	-	-	40
48	-	76.7	81.3	81.1	80.8	80.2	79.8	70.6	64.8	60.8	54.1	-	-	-	-	-	48
56	-	-	73.0	72.6	71.5	70.1	70.8	61.8	57.3	54.6	50.1	45.0	38.7	-	-	-	56
64	-	-	52.0	60.2	60.9	60.6	58.3	54.5	50.9	48.8	45.5	42.1	37.0	28.2	-	-	64
72	-	-	-	52.4	51.8	50.3	48.1	47.1	44.9	43.5	40.9	38.9	34.7	26.9	-	-	72
80	-	-	-	-	44.2	42.6	40.4	39.6	39.2	38.4	36.9	35.6	32.5	25.5	-	-	80
88	-	-	-	-	38.1	36.5	35.8	35.6	33.6	33.3	32.8	32.3	30.1	23.7	-	-	88
96	-	-	-	-	15.8	31.7	31.4	30.9	28.6	28.9	28.9	28.6	27.9	21.6	-	-	96
104	-	-	-	-	-	28.1	28.8	27.2	25.2	24.7	25.6	25.0	25.2	19.4	-	-	104
112	-	-	-	-	-	-	25.4	23.9	23.0	22.4	23.4	23.0	21.7	17.5	-	-	112
120	-	-	-	-	-	-	12.6	21.0	21.2	20.8	20.7	19.9	18.7	15.5	-	-	120
128	-	-	-	-	-	-	-	19.3	19.1	18.8	18.5	17.3	16.0	13.9	-	-	128
136	-	-	-	-	-	-	-	12.3	17.2	17.3	16.6	14.9	13.7	12.4	-	-	136
144	-	-	-	-	-	-	-	-	16.1	15.5	14.4	12.9	12.2	11.1	-	-	144
152	-	-	-	-	-	-	-	-	-	13.9	12.8	11.0	11.0	9.7	-	-	152
160	-	-	-	-	-	-	-	-	-	-	11.2	9.5	9.5	8.2	-	-	160
168	-	-	-	-	-	-	-	-	-	-	-	8.3	8.2	6.8	-	-	168
176	-	-	-	-	-	-	-	-	-	-	-	7.6	7.0	5.5	-	-	176
184	-	-	-	-	-	-	-	-	-	-	-	6.9	5.8	4.4	-	-	184
192	-	-	-	-	-	-	-	-	-	-	-	-	4.7	-	-	-	192
200	-	-	-	-	-	-	-	-	-	-	-	-	3.9	-	-	-	200
1)	40.6	30.2	23.6	18.5	14.8	11.5	8.8	6.2	4.0	2.6	-	-	-	-	-	-	1)

1) Capacities with horizontal boom

41,200 lb		27.60 ft x 29.10 ft												360°		85%	
ft	41.7ft	55.4ft	69.6ft	83.3ft	97.4ft	111.2ft	125.3ft	139.1ft	153.2ft	166.3ft	180.1ft	194.9ft	209.0ft	229.7ft	ft		
1,000 lb																	
10	82.5	82.5	82.5	-	-	-	-	-	-	-	-	-	-	-	10		
12	82.5	82.5	82.5	-	-	-	-	-	-	-	-	-	-	-	12		
14	82.5	82.5	82.5	82.5	-	-	-	-	-	-	-	-	-	-	14		
16	82.5	82.5	82.5	82.5	82.5	-	-	-	-	-	-	-	-	-	16		
18	82.5	82.5	82.5	82.5	82.5	-	-	-	-	-	-	-	-	-	18		
20	82.5	82.5	82.5	82.5	82.5	82.5	-	-	-	-	-	-	-	-	20		
24	82.5	82.5	82.5	82.5	82.5	82.5	82.5	-	-	-	-	-	-	-	24		
28	82.5	82.5	82.5	82.5	82.5	82.5	82.5	82.5	-	-	-	-	-	-	28		
32	82.5	82.5	82.5	82.5	82.5	82.5	82.5	82.0	-	-	-	-	-	-	32		
36	-	78.5	79.0	78.7	79.9	77.9	75.7	73.5	68.3	-	-	-	-	-	36		
40	-	72.6	73.7	73.3	75.4	71.6	68.5	64.6	62.3	57.7	-	-	-	-	40		
48	-	44.3	55.6	56.0	55.0	54.3	52.2	51.3	48.9	47.6	44.4	-	-	-	48		
56	-	-	42.5	42.7	41.8	42.4	41.6	41.3	40.0	38.8	37.6	34.3	31.9	-	56		
64	-	-	33.4	33.6	34.8	34.3	33.5	33.0	33.4	32.7	30.4	29.1	26.4	23.8	64		
72	-	-	-	28.5	28.6	27.7	28.1	28.1	27.5	26.2	26.1	23.9	21.3	18.8	72		
80	-	-	-	-	23.6	23.7	23.8	23.2	22.5	22.5	21.4	19.5	17.1	14.9	80		
88	-	-	-	-	19.8	20.2	20.0	19.5	18.4	18.6	17.3	16.0	13.7	11.5	88		
96	-	-	-	-	15.8	17.0	16.8	16.1	15.2	15.2	14.1	12.8	10.7	8.5	96		
104	-	-	-	-	-	14.6	14.2	13.3	12.5	12.5	11.4	10.0	8.2	6.2	104		
112	-	-	-	-	-	-	12.0	11.1	10.2	10.3	9.1	7.8	6.3	4.3	112		
120	-	-	-	-	-	-	10.0	9.3	8.2	8.4	7.1	5.9	4.4	-	120		
128	-	-	-	-	-	-	-	7.6	6.7	6.7	5.5	4.3	-	-	128		
136	-	-	-	-	-	-	-	6.3	5.4	5.4	4.0	2.9	-	-	136		
144	-	-	-	-	-	-	-	-	4.0	4.0	2.9	-	-	-	144		
152	-	-	-	-	-	-	-	-	-	3.0	-	-	-	-	152		
1)	40.6	30.2	23.6	18.5	14.8	11.5	8.8	6.2	3.5	-	-	-	-	-	1)		

1) Capacities with horizontal boom

0 lb		27.60 ft x 29.10 ft											360°		85%	
ft		41.7ft	55.4ft	69.6ft	83.3ft	97.4ft	111.2ft	125.3ft	139.1ft	153.2ft	166.3ft	180.1ft	194.9ft	ft		
1,000 lb																
10	82.5	82.5	82.5	-	-	-	-	-	-	-	-	-	-	10		
12	82.5	82.5	82.5	-	-	-	-	-	-	-	-	-	-	12		
14	82.5	82.5	82.5	82.5	-	-	-	-	-	-	-	-	-	14		
16	82.5	82.5	82.5	82.5	82.5	-	-	-	-	-	-	-	-	16		
18	82.5	82.5	82.5	82.5	82.5	-	-	-	-	-	-	-	-	18		
20	82.5	82.5	82.5	82.5	82.5	82.5	-	-	-	-	-	-	-	20		
24	82.5	82.5	82.5	82.5	82.2	80.8	78.2	-	-	-	-	-	-	24		
28	75.4	78.2	79.6	77.4	74.3	70.3	65.5	57.9	-	-	-	-	-	28		
32	57.9	63.5	66.5	64.5	61.1	58.5	55.2	53.0	-	-	-	-	-	32		
36	-	51.2	53.5	52.9	52.2	49.9	46.4	45.9	42.8	-	-	-	-	36		
40	-	40.1	42.3	44.7	44.5	42.6	41.4	38.6	36.0	34.7	-	-	-	40		
48	-	17.0	30.6	31.7	32.1	32.0	31.0	28.6	26.6	25.8	23.2	-	-	48		
56	-	-	22.4	23.3	24.1	23.8	23.4	21.7	20.0	19.4	17.2	14.6	-	56		
64	-	-	16.5	17.4	18.2	18.0	17.6	16.4	15.0	14.5	12.6	10.3	-	64		
72	-	-	-	13.1	13.8	13.5	13.3	12.4	11.1	10.9	8.9	6.5	-	72		
80	-	-	-	-	10.6	10.2	9.9	9.1	8.1	7.8	6.0	-	-	80		
88	-	-	-	-	7.9	7.6	7.3	6.5	5.4	5.4	3.6	-	-	88		
96	-	-	-	-	5.9	5.4	5.2	4.3	3.2	3.4	-	-	-	96		
104	-	-	-	-	-	3.7	3.3	2.4	-	-	-	-	-	104		
1)	37.9	22.5	14.8	9.5	6.0	2.9	-	-	-	-	-	-	-	1)		

1) Capacities with horizontal boom

Ratings are in compliance with ASME B30.5.
Lifting capacities do not exceed 85 % of tipping load.

Consult operation manual for further details.

Note: Data published herein is intended as a guide only and shall not be construed to warrant applicability for lifting purposes. Crane operation is subject to the computer charts and operation manual both supplied with the crane.

Basic machine

Equipment carrier

Engine 368-4; Euromot 4/Tier 4F	Scania DC13; Diesel engine; 368 kW / 2100 1/min (500 HP), torque 2373 Nm / 1300 1/min; The engine complies with Euromot 4/Tier 4F; Exhaust system complete stainless steel.
Fuel tank	Fuel tank 132 gallons Diesel (no RME / biodiesel); 16 gallons AdBlue tank.
Transmission AS12INT	ZF AS-Tronic; Automated gearbox with integrated hydraulic retarder, 12 forward speeds and 2 reverse; 2-stage transfer case with switchable off-road gear.
Axles 10 x 6 x 10	10 x 6 x 10; Five axles, axles 3-5 are driven and dispose of a selectable transverse lock; Axle 4 with selectable longitudinal lock; All axles steered.
Suspension	Hydropneumatic suspension with axle load compensation; Hydraulically lockable.
Steering	Dual-circuit steering system with independent rear axle steering; Axles 1, 2, 3 mechanically connected; Axles 4 and 5 electro-hydraulically connected, all axles steered with 6 different steering programs.
Brakes	Pneumatic dual circuit service brake, acting on all wheels; Disc brakes; Hydraulic retarder integrated into transmission as wear-free sustained-action brake; Additional exhaust brake; Parking brake.
Tires size 385/95 R25 (14.00R25)	Tires size 385/95 R25 (14.00R25); Steel rim 9,5-25/1,7"; Magna MA03 170F or similar.
Carrier cab 2850	S-PACE type 9.35 ft; Adjustable driver seat, armrests and pneumatic suspension; Height and tilt-adjustable steering wheel; Auxiliary / passenger seat; Powered door windows; Tinted glass; Central door locking; Electrically adjustable rear-view mirrors, heated; Preparation for radio.
Carrier heating	Engine-dependent warm water heating with 12 kW heating power.
Drive lights	Including low beams, high beams, daytime running lights.
Electronic immobilizer system	Prevents uncontrolled carrier mobilization; Incl. 3 electronic keys.
Pneumatic system adapter for inflating tires	Pneumatic system adapter for inflating tires makes it possible for operators to inflate tires by themselves.
Jump starting device	Jump starting installation designed to make it possible to jump-start using a separate source of power.
Contour safety marking	Continuous reflective strips on the sides of the chassis and on the rear.

Equipment superstructure

Telescopic boom HA70	41.7 ft - 229.7 ft; Single cylinder telescoping system, automatic telescoping; Attachments for all equipment and extensions; 4 sheaves integrated in boom head for max. capacity of 168,900 lb.
Boom luffing	1 luffing cylinder with automatic lowering brake valve.
Rotary drive	Single slewing gear unit with spring-loaded multi-disc brake; Different operating modes selectable.
H1	Hoist with spring-loaded multi-disc brake; Resolver (hoist rotation indicator); Rope twist prevention is not included.
Counterweight 113,800 lb	Counterweight 113,800 lb, 6 pieces (a-e).
Outriggers	H-4-point design; Vertical and horizontal movement fully hydraulic; 4 outrigger bases: 9.0 ft, 18.2 ft, 23.0 ft, 27.6 ft.
Outrigger pads 038PA	4 round polyamide outrigger pads A = 1.25 ft ² with transport position at vertical cylinder.
Outrigger basis monitoring	Individual monitoring of horizontal stroke; Deviation warning in crane cab.
Control system	Enabling 4 simultaneous working movements; Electric pilot controls via 2 two-axis joysticks; Different control modes selectable for hydraulic circuits.
Operator aids	IC-1, with integrated electronic load moment indicator in accordance with EN13000; Color display; Displaying of current operating conditions, load charts, fault indicator; Signal lights indicating LMI-load; Crane data logger.
Crane cab 875	S-PACE type 875; Tilt infinitely variable 16°; Sliding window rear; Fold-out front window; Extendable side pedestal, front pedestal; Handrails; Tinted safety glass; Pull-down sun visor; Preparation for radio.
Heating crane cab	Engine-independent warm water heating with 5 kW heating power.
Anemometer	Removable, to be used with all extensions.

Additional equipment

Carrier

Engine 331-3a; Euromot 3a / Tier 3	Scania DC13; Diesel engine; 331 kW / 2100 1/min (450 HP), torque 2007 Nm / 1575 1/min; The engine complies with Euromot 3a / Tier 3; Exhaust system optional with spark arrester.
Axles 10 x 8 x 10	10 x 8 x 10; Five axles, axles 2-5 are driven and dispose of a selectable transverse lock; Axles 3 and 4 with selectable longitudinal lock; All axles steered.
Additional fuel tank	Additional fuel tank 53 gallons; For 185 gallons diesel total in carrier (no RME / biodiesel).
Air conditioning	Air conditioning for carrier cab, 7 kW rated cooling power.

Superstructure

Additional sheave on main boom head	1 additional sheave; Dis-/connectable; For total 5 sheaves at boom head; Max. capacity 209,000 lb.
S1 Heavy lift attachment, stage 1	2 additional sheaves; Dis-/connectable; For total 7 sheaves at boom head; Max. capacity 286,600 lb.
2. hoist (H2)	2. hoist; Spring-loaded multi-disc brake; Integrated resolver (hoist rotation indicator); Incl. quick couplings and transport rack; Rope twist prevention is not included.
Additional counterweight 41,000 lb	Additional counterweight 41,000 lb; 2 pieces; for total 154,800 lb, 8 pieces.
Air conditioning	Air conditioning in crane cab with 5 kW rated cooling power.

Handling

Remote control	Control of superstructure movements via wireless remote control.
Outrigger load indicator	The outrigger load is indicated in the operator cab and the outrigger control box.
Working range limiter IC-1 Plus	Displaying and programmability of the work range limits by IC-1. Smart crane control system enabling higher lifting capacities especially over outriggers. Enables safe use of the full capacity of the crane even in asymmetric outrigger configurations. Outriggers can be positioned independently. Capacity precalculation for +/- 30° slewing angle and radius area. Provided with graphical lift planning application. In-cab lift simulation.

Extensions

HAV 36.1 ft	37.4 ft; Lattice swing-away jib, manually offsettable 20°/40°; 1-sheaved head; Incl. transport storage; Cannot be carried while maintaining 26,500 lb axle load.
HAV 68.9 ft	68.9 ft; Double folding swing-away jib, manually offsettable 20°/40°; 1-sheaved head; Incl. transport storage; Cannot be carried while maintaining 26,500 lb axle load; Includes HAV 36.1 ft.
HAV-VA 108.3 ft	108.3 ft; Variable extension; Single piece, 39.4 ft lattice boom extension and double folding swing-away jib, manually offsettable 20°/40°; 1-sheaved head; Incl. transport storage for double folding swing-away jib; Includes HAV 36.1 ft, HAV 68.9 ft and HAV-VA 75.5 ft.
HAV-HY	Hydraulic offset 0°-40° instead of manual offset 20°/40°; available for HAV 36.1 ft, HAV 68.9 ft, HAV-VA 108.3 ft.
MS (runner)	5.25 ft; Fixed angle runner; 2 sheaves, for max. 86,200 lb lifting capacity; Incl. transport storage at boom head.

Hook Blocks

Hook block 160-7-21-D-1500	160-7-21-D (3310 lb); Hook block with ramshorn hook; white with red signal stripes.
Hook block 125-5-21-D-1125	125-5-21-D (2480 lb); Hook block with ramshorn hook; white with red signal stripes.
Hook block 80-3-21-D-850	80-3-21-D (1870 lb); Hook block with ramshorn hook; white with red signal stripes.
Hook block 32-1B-21-D-Vario	32-1B-21-D (441 lb / 1320 lb); Hook block with ramshorn hook, ballast transported separately on rear of carrier, requires storage; white with red signal stripes.
Hook block 32-1-21-D-600	32-1-21-D (1320 lb); Hook block with ramshorn hook; white with red signal stripes.
Hook 12-0V-E-350	12-0V-E (770 lb); Single hook with vertical swivel; red.

Further additional equipment on request!

Weight data may deviate from posted values based on road / travel configuration, equipment configuration, and component weight tolerances.

Lined area for notes.

A large rectangular area with horizontal lines, intended for taking notes.

Effective Date: February 2016.

Product specifications and prices are subject to change without notice or obligation. The photographs and/or drawings in this document are for illustrative purposes only. Refer to the appropriate Operator's Manual for instructions on the proper use of this equipment. Failure to follow the appropriate Operator's Manual when using our equipment or to otherwise act irresponsibly may result in serious injury or death. The only warranty applicable to our equipment is the standard written warranty applicable to the particular product and sale and Terex makes no other warranty, express or implied. Products and services listed may be trademarks, service marks or trade-names of Terex Corporation and/or its subsidiaries in the USA and other countries. All rights are reserved. Terex® is a registered trademark of Terex Corporation in the USA and many other countries.

Copyright Terex Cranes 2016



Terex Cranes
Global Marketing
Dinglerstraße 24 · 66482 Zweibrücken / Germany
Phone +49 (0) 6332 830
Email: info.cranes@terex.com

www.terex.com/cranes