

AC 300-6

PRELIMINARY

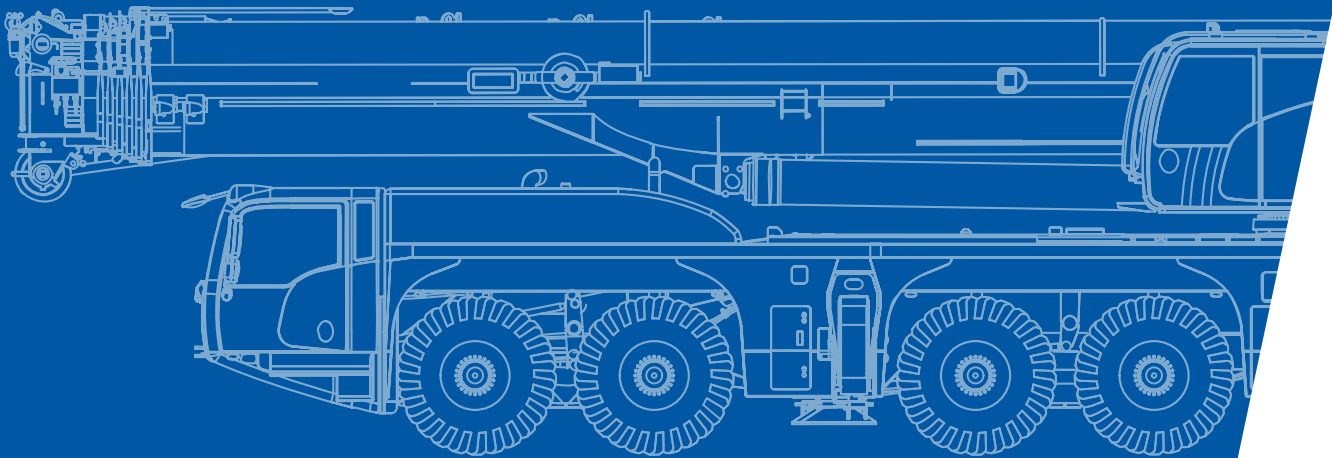

**All Terrain Crane
350 USt Capacity class**

DEMAG[®]
BY TEREX

Courtesy of Crane.Market

	Page:
Dimensions	4
Specifications	6
Equipment	7
Counterweight	8

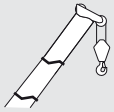

HA

Main boom	10
-----------------	----



HAV



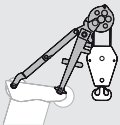











Folding swing-away jib	13
------------------------------	----

















MS

Runner	16
--------------	----

Technical description	20
-----------------------------	----

	Counterweight
	Lifting capacities on outriggers - 360°
	Radius
	Main boom
	Folding swing-away jib
	Runner
	Max. axle loads
	Mechanism
	Tires
	Hook block
	Hoist
	Dolly
	Travel speed
	Gradeability – road
	Gradeability – off road

	Slewing
	Boom telescoping
	Boom elevation
	Working speeds
	Max. line pull
	Rope diameter
	Rope length
	Hook block (capacity-sheaves-rope diameter)
	Number of lines
	Possible load of hook block
	Weight of hook block
	Distance head sheave axle – hook ground
	Number of sheaves in boom head
	Supporting force
	Length of stroke (support cylinders)

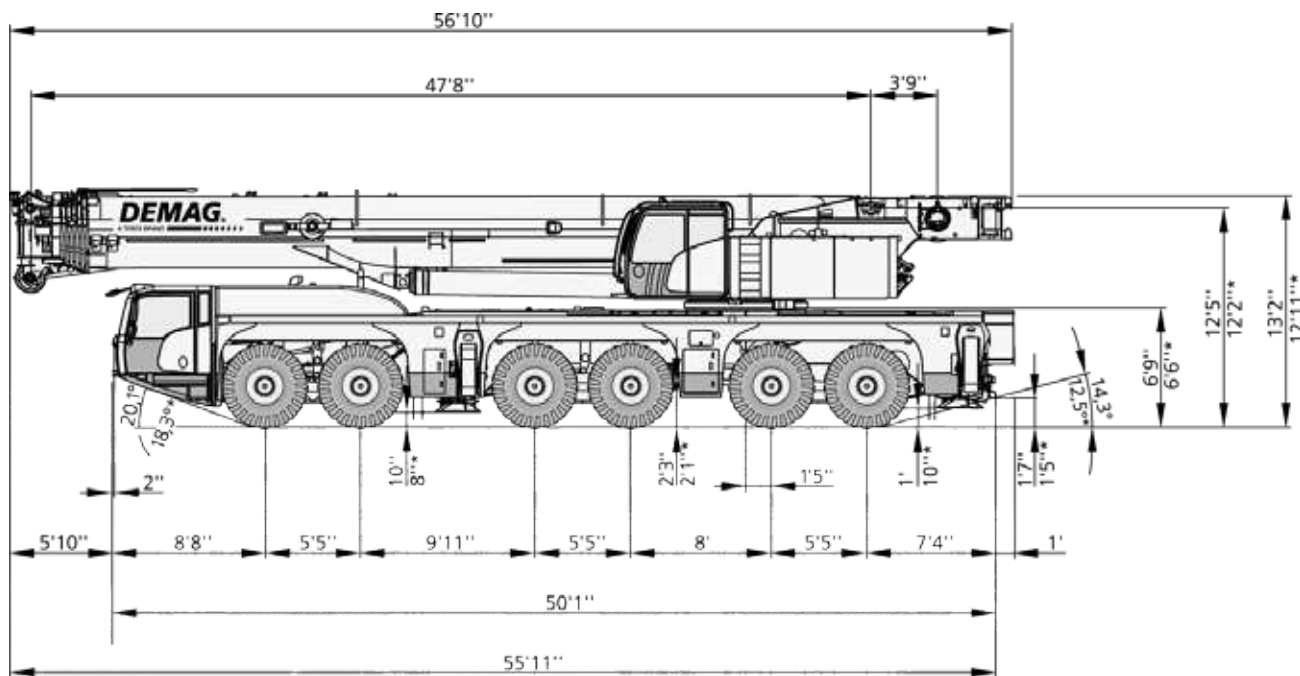

⊙ 445/95 R25 / 525/80 R25

* ⊙ 385/95 R25

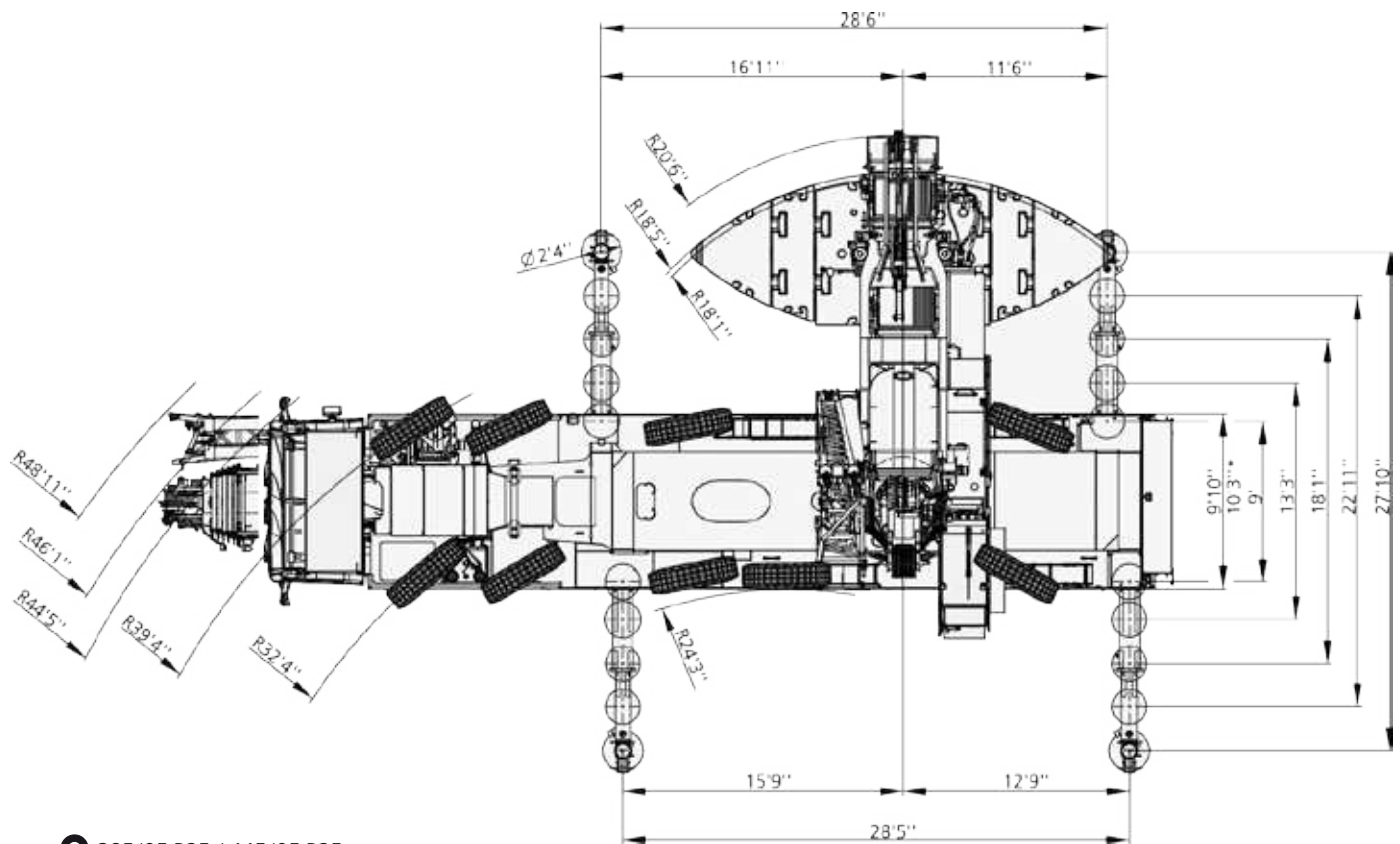















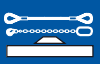

⊙ 385/95 R25 / 445/95 R25

* ⊙ 525/80 R25





Specifications

AC 300-6



										
	Total									
< 26,500 lb	On request and technical verification!									X
26,500 lb	158,800 lb	12 x 6 x 10	385/95R25	262.5 ft	40-1-24	-	-	-	1,540 lb	-
26,500 lb	158,800 lb	12 x 8 x 12	445/95R25	262.5 ft	-	-	-	-	-	-
35,300 lb	209,500 lb	12 x 8 x 12	445/95R25	262.5 ft	80-3-23	42,300 lb	68.9 ft	-	1,760 lb	-











	1 Highway > 28 mph		4* Off-wall
	2 City < 28 mph		5* Crab steer mode
	3* Minimum turning radius < 12.4 mph		6* Manually steered







* must be activated

		
	249,200 lb	284,500 lb
	19.3"	22.0"
		52.8 mph ¹⁾

¹⁾ Depending on tire type, size and country specific legislation

	385 / 95 R 25 14.00 R 25	445 / 95 R 25 16.00 R 25	525 / 80 R 25 20.50 R 25
	51 %	45 %	45 %
	63 %	56 %	56 %

				
	413.4 ft/min	25,850 lbf	0.92"	1200 ft
	413.4 ft/min	25,850 lbf	0.92"	1200 ft
	1,0 min ⁻¹			
	596 s (47.6-262.5 ft)			
	57 s (0°-83°)			

					
1	23,700	12,5-0-24	4	1,100	6.6 ft
2	47,400	40-1-24	4	1,650	8.9 ft
3	71,100	40-1-24	4	1,650	8.9 ft
4	94,800	80-3-23	4	2,320	9.8 ft
5	118,500	80-3-23	4	2,320	9.8 ft
6	142,100	80-3-23	4	2,320	9.8 ft
7	165,800	80-3-23	4	2,320	9.8 ft
8	189,500	125-5-23	4	2,650	9.8 ft
9	213,200	125-5-23	4 + 1	2,650	9.8 ft
10	236,900	125-5-23	4 + 1	2,650	9.8 ft
11	260,600	125-5-23	4 + 1 + 2	2,650	9.8 ft
12	284,300	160-7-23	4 + 1 + 2	3,750	9.8 ft
13	308,000	160-7-23	4 + 1 + 2	3,750	9.8 ft
14	330,700	160-7-23	4 + 1 + 2	3,750	9.8 ft

HAV

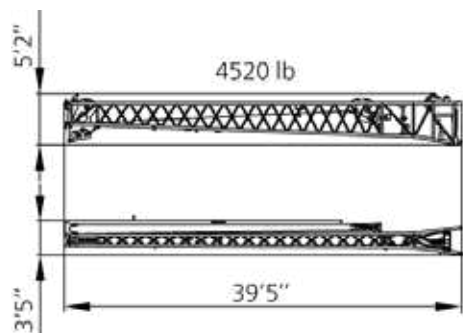

HAV 68.9 ft

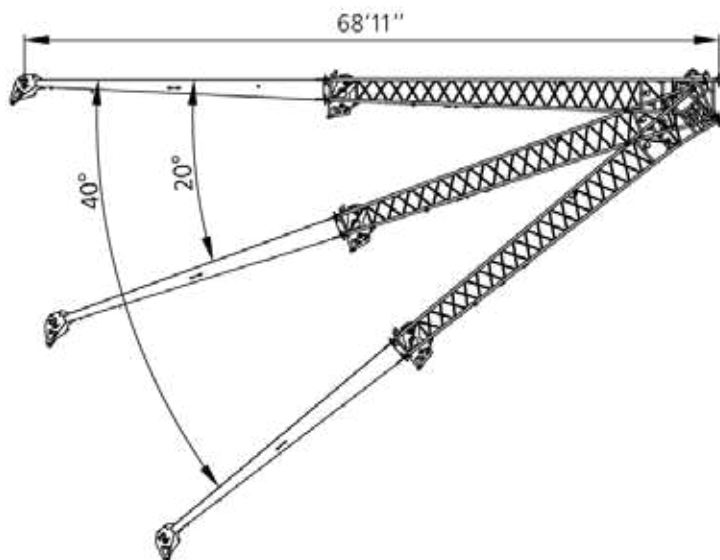

HAV 36.1 ft

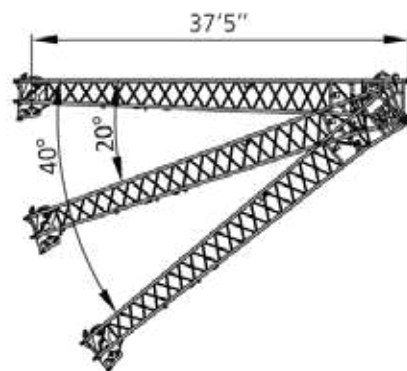

Counterweight

AC 300-6

Parts

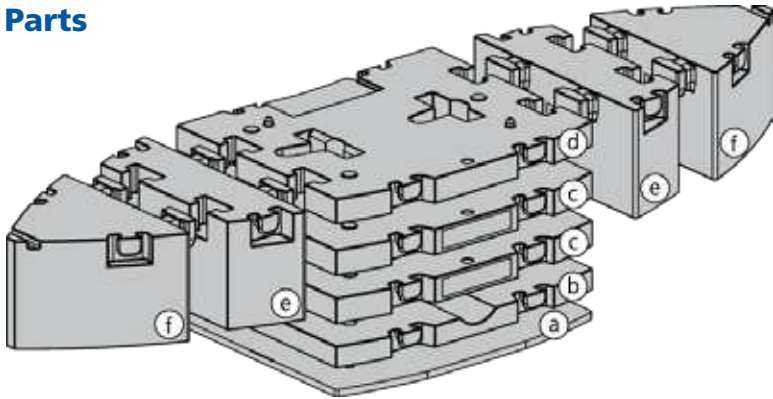

STANDARD

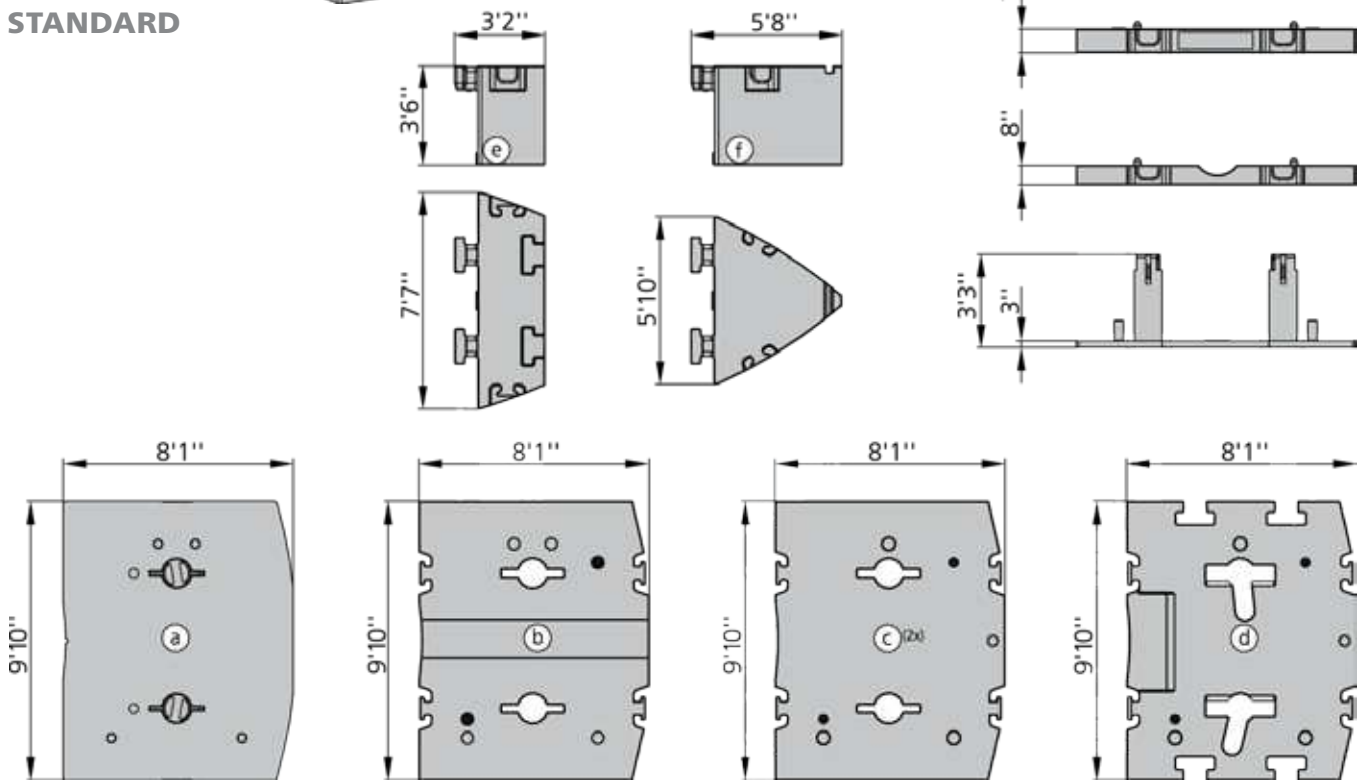

Configurations

	Ⓐ 10,800 lb	Ⓑ 21,200 lb	Ⓒ 26,900 lb	Ⓒ 26,900 lb	Ⓓ 24,000 lb	Ⓔ 24,300 lb	Ⓔ 24,300 lb	Ⓕ 24,300 lb	Ⓕ 24,300 lb
0 lb									
10,800 lb	X								
32,000 lb	X	X							
58,900 lb	X	X	X						
85,800 lb	X	X	X	X					
109,800 lb	X	X	X	X	X				
158,300 lb	X	X	X	X	X	X	X		
158,300 lb	X	X	X	X	X			X	X
206,800 lb	X	X	X	X	X	X	X	X	X

Counterweight

AC 300-6

Parts

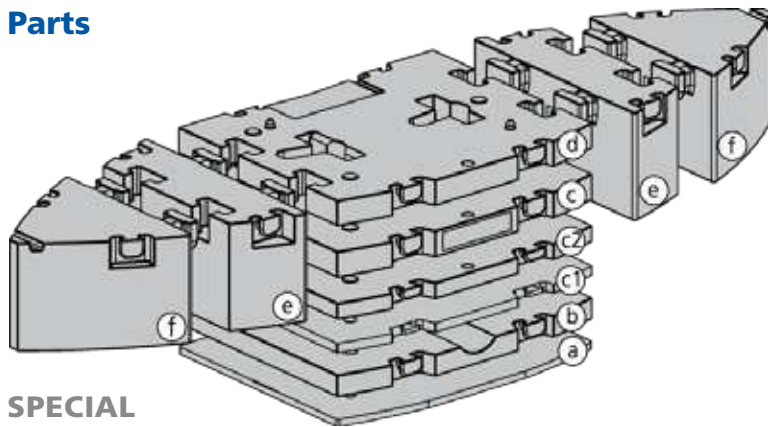

SPECIAL

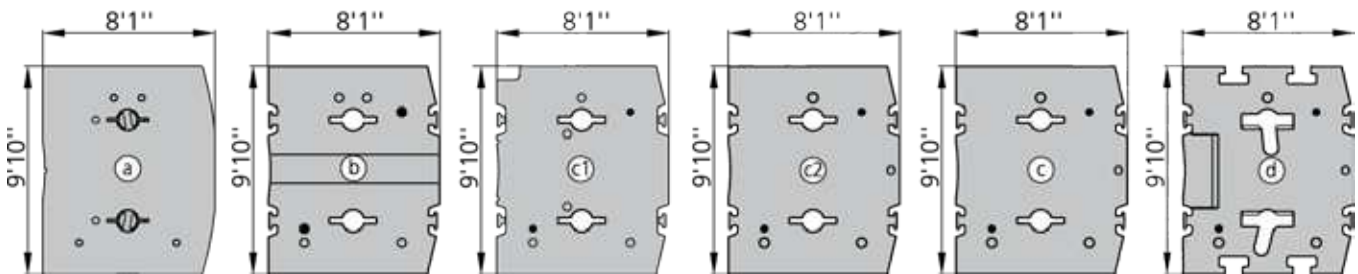
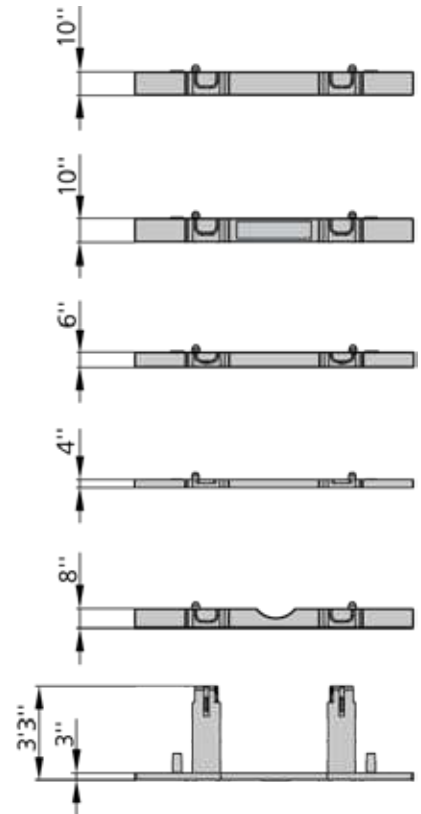
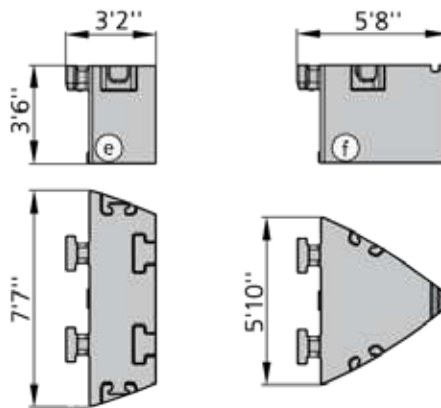

Configurations

	Ⓐ 10,800 lb	Ⓑ 21,200 lb	Ⓒ 10,400 lb	Ⓓ 16,500 lb	Ⓔ 26,900 lb	Ⓕ 24,000 lb	Ⓖ 24,300 lb	Ⓗ 24,300 lb	Ⓙ 24,300 lb	Ⓚ 24,300 lb
0 lb										
10,800 lb	X									
32,000 lb	X	X								
42,300 lb	X	X	X							
58,900 lb	X	X	X	X						
85,800 lb	X	X	X	X	X					
109,800 lb	X	X	X	X	X	X				
158,300 lb	X	X	X	X	X	X	X	X		
158,300 lb	X	X	X	X	X	X			X	X
206,800 lb	X	X	X	X	X	X	X	X	X	X



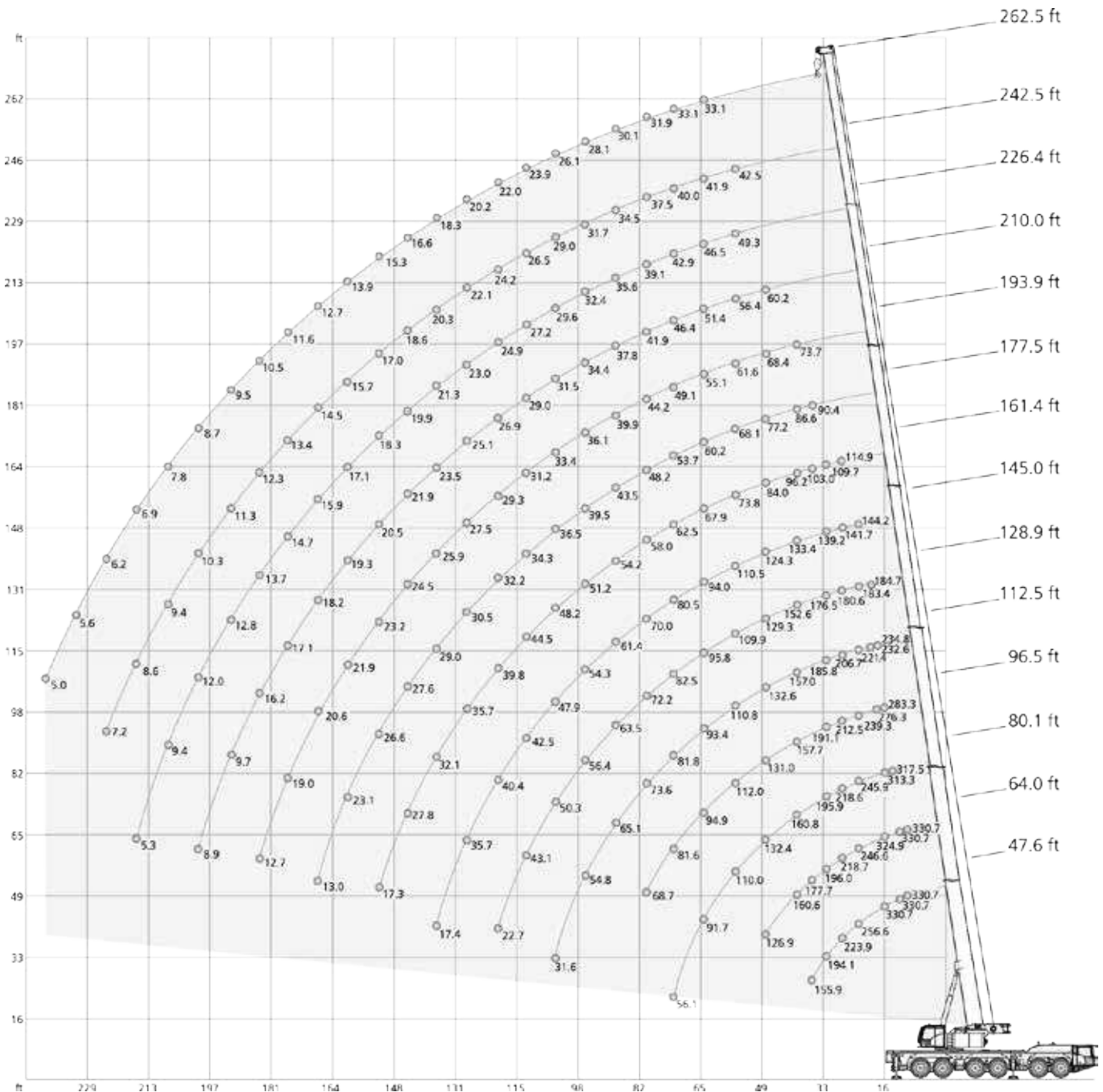
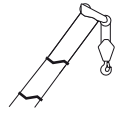







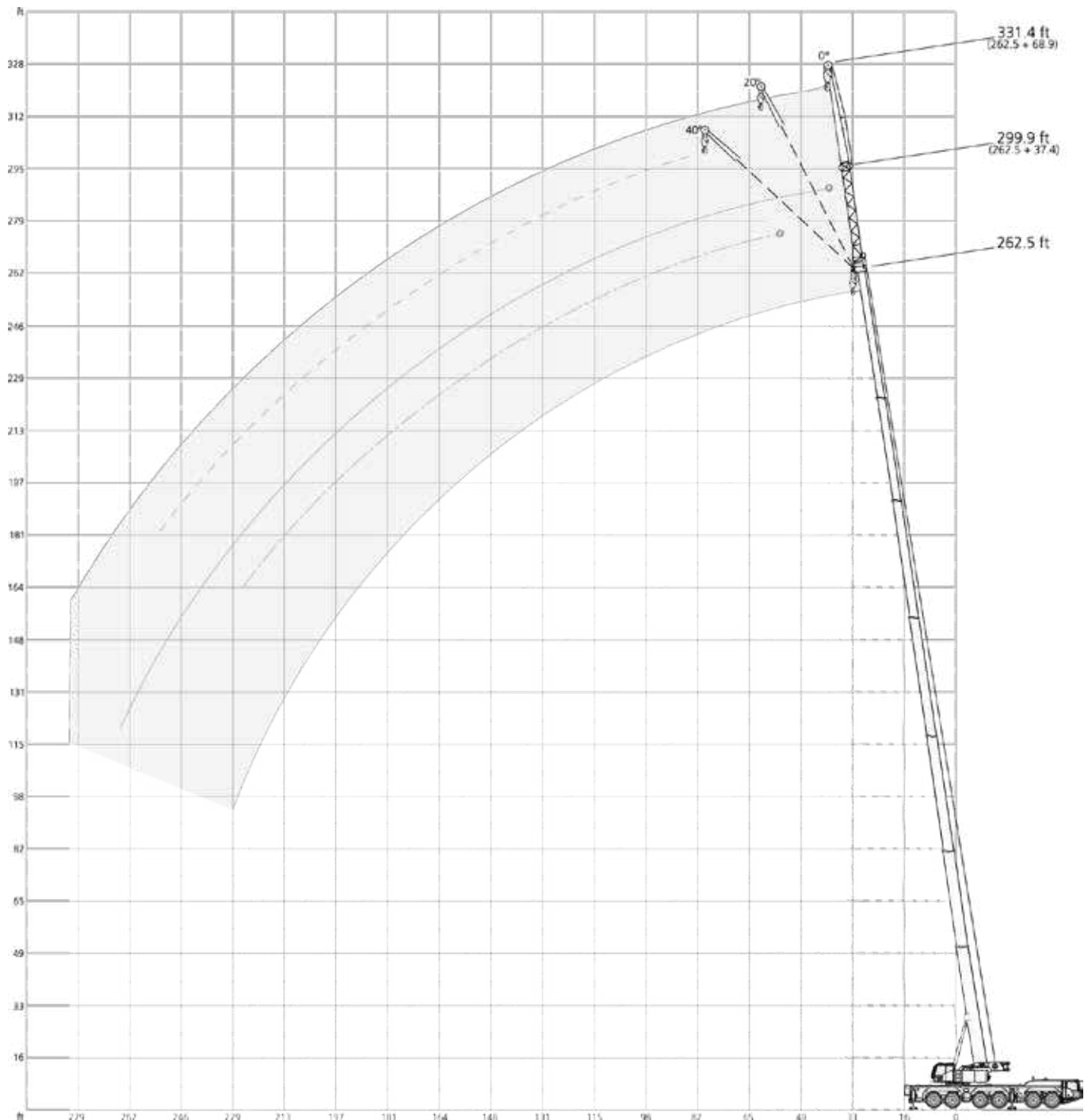
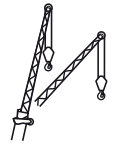

206,800 lb		28.5 ft x 27.8 ft														360°		85%	
0°		(ft)														360°			
ft		47.6	47.6	64.0	80.1	96.5	112.5	128.9	145.0	161.4	177.5	193.9	210.0	226.4	242.5	262.5	ft		
ft		1,000 lb														ft			
	700.0*	-	-	-	-	-	-	-	-	-	-	-	-	-	-	-			
10	330.7	330.7	330.7	317.5	-	-	-	-	-	-	-	-	-	-	-	-		10	
12	330.7	330.7	330.7	317.5	283.3	-	-	-	-	-	-	-	-	-	-	-		12	
14	330.7	330.7	330.7	317.5	283.3	-	-	-	-	-	-	-	-	-	-	-		14	
16	330.7	323.2	324.9	313.3	283.3	-	-	-	-	-	-	-	-	-	-	-		16	
18	315.2	302.6	304.8	298.0	276.3	234.8	-	-	-	-	-	-	-	-	-	-		18	
20	295.6	280.3	282.5	280.4	266.8	232.6	184.7	-	-	-	-	-	-	-	-	-		20	
24	256.6	244.8	246.6	245.9	239.3	221.4	183.4	144.2	-	-	-	-	-	-	-	-		24	
28	223.9	217.0	218.7	218.6	212.5	206.7	180.6	141.7	114.9	-	-	-	-	-	-	-		28	
32	194.1	192.8	196.0	195.9	191.1	185.8	176.5	139.2	109.7	-	-	-	-	-	-	-		32	
36	155.9	155.9	177.7	177.7	173.8	170.3	165.4	136.4	103.0	90.4	-	-	-	-	-	-		36	
40	-	-	160.6	160.8	157.7	157.0	152.6	133.4	96.2	86.6	73.7	-	-	-	-	-		40	
48	-	-	126.9	132.4	131.0	132.6	129.3	124.3	84.0	77.2	68.4	60.2	-	-	-	-		48	
56	-	-	-	110.0	112.0	110.8	109.9	110.5	73.8	68.1	61.6	56.4	49.3	42.5	-	-		56	
64	-	-	-	91.7	94.9	93.4	95.8	94.0	67.9	60.2	55.1	51.4	46.5	41.9	33.1	-		64	
72	-	-	-	56.1	81.6	81.8	82.5	80.5	62.5	53.7	49.1	46.4	42.9	40.0	33.1	-		72	
80	-	-	-	-	68.7	73.6	72.2	70.0	58.0	48.2	44.2	41.9	39.1	37.5	31.9	-		80	
88	-	-	-	-	-	65.1	63.5	61.4	54.2	43.5	39.9	37.8	35.6	34.5	30.1	-		88	
96	-	-	-	-	-	54.8	56.4	54.3	51.2	39.5	36.1	34.4	32.4	31.7	28.1	-		96	
104	-	-	-	-	-	31.6	50.3	47.9	48.2	36.5	33.4	31.5	29.6	29.0	26.1	-		104	
112	-	-	-	-	-	-	43.1	42.5	44.5	34.3	31.2	29.0	27.2	26.5	23.9	-		112	
120	-	-	-	-	-	-	22.7	40.4	39.8	32.2	29.3	26.9	24.9	24.2	22.0	-		120	
128	-	-	-	-	-	-	-	35.7	35.7	30.5	27.5	25.1	23.0	22.1	20.2	-		128	
136	-	-	-	-	-	-	-	17.4	32.1	29.0	25.9	23.5	21.3	20.3	18.3	-		136	
144	-	-	-	-	-	-	-	16.6	27.8	27.6	24.5	21.9	19.9	18.6	16.6	-		144	
152	-	-	-	-	-	-	-	-	17.3	26.6	23.2	20.5	18.3	17.0	15.3	-		152	
160	-	-	-	-	-	-	-	-	-	23.1	21.9	19.3	17.1	15.7	13.9	-		160	
168	-	-	-	-	-	-	-	-	-	13.0	20.6	18.2	15.9	14.5	12.7	-		168	
176	-	-	-	-	-	-	-	-	-	12.2	19.0	17.1	14.7	13.4	11.6	-		176	
184	-	-	-	-	-	-	-	-	-	-	12.7	16.2	13.7	12.3	10.5	-		184	
192	-	-	-	-	-	-	-	-	-	-	-	9.7	12.8	11.3	9.5	-		192	
200	-	-	-	-	-	-	-	-	-	-	-	8.9	12.0	10.3	8.7	-		200	
208	-	-	-	-	-	-	-	-	-	-	-	7.8	9.4	9.4	7.8	-		208	
216	-	-	-	-	-	-	-	-	-	-	-	6.3	5.3	8.6	6.9	-		216	
224	-	-	-	-	-	-	-	-	-	-	-	-	-	7.2	6.2	-		224	
232	-	-	-	-	-	-	-	-	-	-	-	-	-	-	5.6	-		232	
240	-	-	-	-	-	-	-	-	-	-	-	-	-	-	5.0	-		240	





* Capacity class





☰ 109,800 lb		🏗️ 28.5 ft x 27.8 ft												360°		85%	
🏗️		(ft)														🏗️	
ft		47.6	64.0	80.1	96.5	112.5	128.9	145.0	161.4	177.5	193.9	210.0	226.4	242.5	262.5	ft	
		1,000 lb															
10		330.7	330.7	317.5	-	-	-	-	-	-	-	-	-	-	-	-	10
12		330.7	330.7	317.5	283.3	-	-	-	-	-	-	-	-	-	-	-	12
14		330.7	330.7	317.5	283.3	-	-	-	-	-	-	-	-	-	-	-	14
16		315.7	316.6	313.3	283.3	-	-	-	-	-	-	-	-	-	-	-	16
18		293.2	294.3	294.3	276.3	234.8	-	-	-	-	-	-	-	-	-	-	18
20		271.6	272.8	272.8	266.7	232.6	184.7	-	-	-	-	-	-	-	-	-	20
24		235.2	237.7	237.7	236.5	220.6	183.4	144.2	-	-	-	-	-	-	-	-	24
28		199.3	202.4	202.5	201.1	198.8	180.6	141.7	114.9	-	-	-	-	-	-	-	28
32		169.1	172.4	172.4	174.1	173.3	164.2	139.2	109.7	-	-	-	-	-	-	-	32
36		143.3	152.3	150.6	153.1	151.6	144.0	131.9	103.0	90.4	-	-	-	-	-	-	36
40		-	132.5	133.6	133.1	131.6	130.9	122.7	96.2	86.6	73.7	-	-	-	-	-	40
48		-	99.0	100.2	103.6	103.0	100.9	96.8	84.0	77.2	68.4	60.2	-	-	-	-	48
56		-	-	81.1	81.7	80.8	78.8	76.1	73.8	68.1	61.6	56.4	49.3	42.5	-	-	56
64		-	-	66.0	66.3	65.2	63.2	63.9	63.0	58.7	55.1	51.4	46.5	41.9	33.1	-	64
72		-	-	54.7	54.7	53.6	54.8	54.0	51.4	49.5	48.4	46.4	42.9	40.0	33.1	-	72
80		-	-	-	46.1	46.3	47.4	45.4	43.6	44.1	42.2	40.8	38.9	37.5	31.9	-	80
88		-	-	-	-	41.7	40.6	38.6	38.8	37.5	37.8	36.8	34.9	34.1	30.1	-	88
96		-	-	-	-	36.2	35.1	34.0	34.2	33.7	32.5	32.0	31.0	29.5	28.1	-	96
104		-	-	-	-	30.9	30.5	31.1	29.6	29.9	29.3	27.9	26.4	26.1	24.6	-	104
112		-	-	-	-	-	26.8	27.6	26.8	26.0	25.4	24.1	22.3	22.5	20.5	-	112
120		-	-	-	-	-	22.7	24.4	24.2	23.2	21.9	20.7	19.1	19.1	17.3	-	120
128		-	-	-	-	-	-	21.5	21.4	20.5	19.2	18.1	16.1	16.3	14.3	-	128
136		-	-	-	-	-	-	17.4	18.9	18.0	16.6	15.5	13.5	13.8	11.8	-	136
144		-	-	-	-	-	-	16.6	16.9	15.9	14.4	13.3	11.3	11.6	9.6	-	144
152		-	-	-	-	-	-	-	15.0	13.9	12.5	11.2	9.4	9.5	7.7	-	152
160		-	-	-	-	-	-	-	-	12.3	10.7	9.6	7.6	7.9	6.1	-	160
168		-	-	-	-	-	-	-	-	10.8	9.3	8.1	6.2	6.3	4.6	-	168
176		-	-	-	-	-	-	-	-	9.5	7.9	6.6	4.8	4.8	3.1	-	176
184		-	-	-	-	-	-	-	-	-	6.7	5.4	3.6	3.6	-	-	184
192		-	-	-	-	-	-	-	-	-	-	4.2	-	-	-	-	192
200		-	-	-	-	-	-	-	-	-	-	3.3	-	-	-	-	200







206,800 lb		28.5 ft x 27.8 ft		360°		85%	
 47.6 ft							
  37.4 ft							
 68.9 ft							
ft	0°	20°	40°	0°	20°	40°	1,000 lb
10	52.0	-	-	-	-	-	-
12	52.0	-	-	24.0	-	-	-
14	52.0	-	-	23.7	-	-	-
16	52.0	-	-	23.3	-	-	-
18	52.0	-	-	22.9	-	-	-
20	52.0	37.5	-	22.6	-	-	-
24	51.1	34.5	-	21.9	-	-	-
28	46.4	31.8	-	21.3	-	-	-
32	41.1	29.7	23.4	20.3	-	-	-
36	37.2	27.8	22.4	19.3	-	-	-
40	33.8	26.0	21.5	18.3	14.2	-	-
48	29.0	23.4	20.2	16.0	12.9	-	-
56	25.4	21.2	19.0	14.3	11.7	-	-
64	22.2	19.7	-	12.7	10.7	9.4	-
72	19.9	18.5	-	11.5	9.9	8.8	-
80	-	-	-	10.5	9.4	8.5	-
88	-	-	-	9.6	8.7	8.2	-
96	-	-	-	9.0	8.5	-	-
104	-	-	-	8.4	-	-	-



 145.0 ft							
  37.4 ft							
 68.9 ft							
ft	0°	20°	40°	0°	20°	40°	1,000 lb
28	52.0	-	-	-	-	19.9	-
32	52.0	-	-	-	-	19.7	-
36	52.0	-	-	-	-	19.3	-
40	51.7	32.5	-	-	-	18.9	-
48	47.3	30.4	22.5	-	-	18.2	-
56	43.0	28.5	21.7	-	-	17.5	13.5
64	39.3	26.8	20.9	-	-	16.9	12.9
72	36.0	25.4	20.3	-	-	16.3	12.1
80	33.1	24.1	19.8	-	-	15.6	11.6
88	30.6	23.0	19.3	-	-	15.0	11.1
96	28.6	22.1	18.9	-	-	14.2	10.5
104	26.9	21.3	18.6	-	-	13.3	10.2
112	25.3	20.5	18.3	-	-	12.5	9.7
120	23.9	19.7	18.1	-	-	11.9	9.4
128	22.7	19.2	18.0	-	-	11.2	9.1
136	21.6	18.6	14.6	-	-	10.7	8.9
144	20.6	18.3	-	-	-	10.4	8.6
152	19.7	18.1	-	-	-	9.9	8.4
160	19.0	11.7	-	-	-	9.5	8.3
168	10.9	-	-	-	-	9.1	8.1
176	10.2	-	-	-	-	8.9	8.0
184	-	-	-	-	-	8.6	7.9
192	-	-	-	-	-	8.3	-
200	-	-	-	-	-	8.2	-



 242.5 ft							
  37.4 ft							
 68.9 ft							
ft	0°	20°	40°	0°	20°	40°	1,000 lb
64	24.5	-	-	12.6	-	-	-
72	24.5	-	-	12.4	-	-	-
80	24.5	23.1	-	12.3	-	-	-
88	24.5	22.4	19.0	12.0	-	-	-
96	24.5	21.8	18.6	11.9	10.9	-	-
104	24.5	21.2	18.3	11.7	10.6	-	-
112	23.7	20.5	18.1	11.5	10.3	8.4	-
120	22.1	20.2	17.8	11.4	9.9	8.2	-
128	20.5	19.6	17.5	11.1	9.6	8.0	-
136	18.9	19.1	17.3	11.0	9.5	7.9	-
144	17.3	17.7	16.6	10.8	9.3	7.9	-
152	15.9	16.4	15.8	10.5	9.0	7.7	-
160	14.6	15.0	15.0	10.4	8.7	7.7	-
168	13.4	13.8	14.0	10.2	8.5	7.7	-
176	12.3	12.7	12.9	10.0	8.4	7.7	-
184	11.2	11.6	11.9	9.6	8.3	7.6	-
192	10.2	10.6	10.8	9.1	8.1	7.5	-
200	9.4	9.7	9.9	8.6	7.8	7.5	-
208	8.6	8.8	8.9	8.1	7.6	7.5	-
216	7.8	8.0	8.0	7.5	7.5	7.5	-
224	7.1	7.2	-	6.9	7.2	7.4	-
232	6.4	6.4	-	6.2	6.9	7.0	-
240	5.7	5.7	-	5.7	6.2	6.2	-
248	5.1	5.1	-	5.2	5.5	-	-
256	-	-	-	4.6	4.8	-	-
264	-	-	-	4.1	4.3	-	-
272	-	-	-	3.5	3.7	-	-
280	-	-	-	3.0	3.0	-	-

 262.5 ft							
  37.4 ft							
 68.9 ft							
ft	0°	20°	40°*	0°*	20°*	40°*	1,000 lb
72	19.2	-	-	-	-	11.2	-
80	19.2	-	-	-	-	11.2	-
88	19.2	19.2	-	-	-	11.0	-
96	19.2	19.2	18.2	-	-	10.9	-
104	19.2	19.2	17.9	-	-	10.8	10.4
112	19.2	19.2	17.6	-	-	10.6	10.1
120	18.9	19.1	17.4	-	-	10.5	9.9
128	17.9	18.2	17.2	-	-	10.4	9.6
136	16.6	17.0	16.7	-	-	10.2	9.3
144	15.5	15.7	15.9	-	-	10.1	9.3
152	14.1	14.6	14.8	-	-	9.9	9.0
160	12.9	13.5	13.9	-	-	9.8	8.7
168	11.7	12.3	12.9	-	-	9.6	8.5
176	10.5	11.2	11.8	-	-	9.3	8.4
184	9.6	10.1	10.9	-	-	9.0	8.3
192	8.6	9.1	10.0	-	-	8.7	8.1
200	7.8	8.3	9.2	-	-	8.2	8.0
208	7.0	7.5	8.4	-	-	7.6	7.6
216	6.2	6.7	7.5	-	-	7.1	7.1
224	5.5	5.9	6.7	-	-	6.4	6.6
232	4.9	5.1	-	-	-	5.8	6.0
240	4.2	4.4	-	-	-	5.1	5.5
248	3.6	3.8	-	-	-	4.5	4.9
256	3.1	3.3	-	-	-	4.0	4.4
264	2.7	2.8	-	-	-	3.4	3.9
272	-	-	-	-	-	2.9	3.3
280	-	-	-	-	-	2.5	2.8

 *258.5 ft

109,800 lb		28.5 ft x 27.8 ft		360°		85%									
 47.6 ft								 145.0 ft							
 37.4 ft				 37.4 ft				 68.9 ft							
0° 20° 40°				0° 20° 40°				0° 20° 40°							
ft								1,000 lb							
10	52.0	-	-	-	-	-	-	28	52.0	-	-	19.9	-	-	
12	52.0	-	-	24.0	-	-	-	32	52.0	-	-	19.7	-	-	
14	52.0	-	-	23.7	-	-	-	36	52.0	-	-	19.3	-	-	
16	52.0	-	-	23.3	-	-	-	40	51.7	32.5	-	18.9	-	-	
18	52.0	-	-	22.9	-	-	-	48	47.3	30.4	22.5	18.2	-	-	
20	52.0	37.5	-	22.6	-	-	-	56	43.0	28.5	21.7	17.5	13.5	-	
24	51.1	34.5	-	21.9	-	-	-	64	39.3	26.8	20.9	16.9	12.9	-	
28	46.4	31.8	-	21.3	-	-	-	72	36.0	25.4	20.3	16.3	12.1	-	
32	41.1	29.7	23.4	20.3	-	-	-	80	33.1	24.1	19.8	15.6	11.6	9.2	
36	37.2	27.8	22.4	19.3	-	-	-	88	30.6	23.0	19.3	15.0	11.1	8.9	
40	33.8	26.0	21.5	18.3	14.2	-	-	96	28.6	22.1	18.9	14.2	10.5	8.7	
48	29.0	23.4	20.2	16.0	12.9	-	-	104	26.7	21.3	18.6	13.3	10.2	8.6	
56	25.4	21.2	19.0	14.3	11.7	-	-	112	24.9	20.5	18.3	12.5	9.7	8.4	
64	22.2	19.7	-	12.7	10.7	9.4	-	120	22.5	19.7	18.1	11.9	9.4	8.2	
72	19.9	18.5	-	11.5	9.9	8.8	-	128	20.3	19.1	18.0	11.2	9.1	8.0	
80	-	-	-	10.5	9.4	8.5	-	136	18.8	18.3	14.6	10.7	8.9	7.9	
88	-	-	-	9.6	8.7	8.2	-	144	16.9	17.5	-	10.4	8.6	7.9	
96	-	-	-	9.0	8.5	-	-	152	15.3	15.4	-	9.9	8.4	7.9	
104	-	-	-	8.4	-	-	-	160	14.3	11.7	-	9.5	8.3	7.9	
								168	10.9	-	-	9.1	8.1	-	
								176	10.2	-	-	8.9	8.0	-	
								184	-	-	-	8.5	7.9	-	
								192	-	-	-	8.3	-	-	
								200	-	-	-	8.2	-	-	



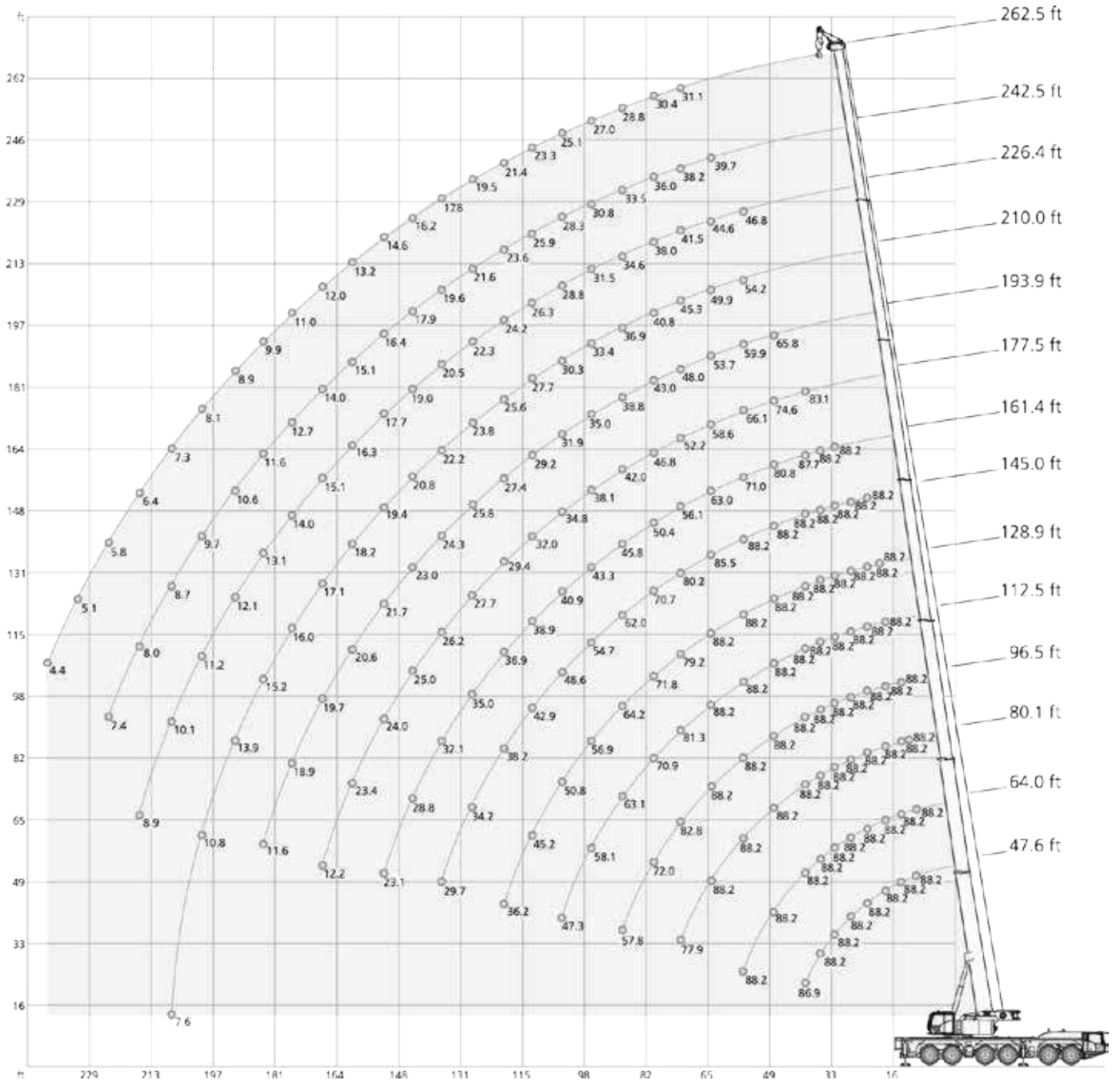
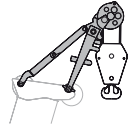

 242.5 ft							
 37.4 ft				 68.9 ft			
0° 20° 40°				0° 20° 40°			
ft							
1,000 lb							
64	24.5	-	-	12.6	-	-	-
72	24.5	-	-	12.4	-	-	-
80	24.5	23.1	-	12.3	-	-	-
88	24.5	22.4	19.0	12.0	-	-	-
96	24.5	21.8	18.6	11.9	10.9	-	-
104	24.1	21.2	18.3	11.7	10.6	-	-
112	21.0	20.5	18.1	11.5	10.3	8.4	-
120	19.0	19.6	17.8	11.4	9.9	8.2	-
128	16.4	18.0	17.4	11.1	9.6	8.0	-
136	13.8	15.6	16.5	11.0	9.5	7.9	-
144	11.6	13.3	14.4	10.6	9.3	7.9	-
152	9.7	11.2	12.3	9.7	9.0	7.7	-
160	7.9	9.3	10.2	8.2	8.7	7.7	-
168	6.4	7.6	8.5	6.8	8.3	7.7	-
176	5.0	6.2	6.8	5.5	7.6	7.7	-
184	3.8	4.8	5.5	4.3	6.3	7.1	-
192	-	-	4.2	-	5.0	6.3	-
200	-	-	2.9	-	3.8	5.0	-
208	-	-	-	-	-	3.8	-
216	-	-	-	-	-	2.7	-

 262.5 ft							
 37.4 ft				 68.9 ft			
0° 20° 40°*				0°* 20°* 40°*			
ft							
1,000 lb							
72	19.2	-	-	11.2	-	-	-
80	19.2	-	-	11.2	-	-	-
88	19.2	19.2	-	11.0	-	-	-
96	19.2	19.2	18.2	10.9	-	-	-
104	19.2	19.2	17.9	10.8	10.4	-	-
112	19.0	19.2	17.6	10.6	10.1	8.4	-
120	16.6	18.6	17.4	10.5	9.9	8.2	-
128	13.9	16.1	17.2	10.4	9.6	8.0	-
136	11.5	13.5	15.6	10.2	9.3	7.9	-
144	9.6	11.3	13.1	9.5	9.3	7.9	-
152	7.7	9.4	11.0	7.7	9.0	7.7	-
160	6.1	7.6	8.9	6.2	8.6	7.7	-
168	4.6	6.0	7.1	4.8	7.4	7.6	-
176	3.1	4.4	5.5	3.5	5.9	7.5	-
184	-	-	4.1	-	4.7	6.5	-
192	-	-	-	-	-	5.2	-
200	-	-	-	-	-	3.9	-

 *258.5 ft



206,800 lb		28.5 ft x 27.8 ft												360°		85%	
		(ft)															
		47.6	64.0	80.1	96.5	112.5	128.9	145.0	161.4	177.5	193.9	210.0	226.4	242.5	262.5		
ft		1,000 lb														ft	
10	88.2	88.2	-	-	-	-	-	-	-	-	-	-	-	-	-	-	10
12	88.2	88.2	88.2	-	-	-	-	-	-	-	-	-	-	-	-	-	12
14	88.2	88.2	88.2	88.2	-	-	-	-	-	-	-	-	-	-	-	-	14
16	88.2	88.2	88.2	88.2	-	-	-	-	-	-	-	-	-	-	-	-	16
18	88.2	88.2	88.2	88.2	88.2	-	-	-	-	-	-	-	-	-	-	-	18
20	88.2	88.2	88.2	88.2	88.2	88.2	-	-	-	-	-	-	-	-	-	-	20
24	88.2	88.2	88.2	88.2	88.2	88.2	88.2	-	-	-	-	-	-	-	-	-	24
28	88.2	88.2	88.2	88.2	88.2	88.2	88.2	88.2	-	-	-	-	-	-	-	-	28
32	88.2	88.2	88.2	88.2	88.2	88.2	88.2	88.2	88.2	-	-	-	-	-	-	-	32
36	88.2	88.2	88.2	88.2	88.2	88.2	88.2	88.2	88.2	-	-	-	-	-	-	-	36
40	86.9	88.2	88.2	88.2	88.2	88.2	88.2	88.2	87.7	83.1	-	-	-	-	-	-	40
48	-	88.2	88.2	88.2	88.2	88.2	88.2	88.2	80.8	74.6	65.8	-	-	-	-	-	48
56	-	88.2	88.2	88.2	88.2	88.2	88.2	88.2	71.0	66.1	59.9	54.2	46.8	-	-	-	56
64	-	-	88.2	88.2	88.2	88.2	88.2	85.5	63.0	58.6	53.7	49.9	44.6	39.7	-	-	64
72	-	-	-	77.9	82.8	81.3	79.2	80.2	56.1	52.2	48.0	45.3	41.5	38.2	31.1	-	72
80	-	-	-	-	72.0	70.9	71.8	70.7	50.4	46.8	43.0	40.8	38.0	36.0	30.4	-	80
88	-	-	-	-	57.8	63.1	64.2	62.0	45.8	42.0	38.8	36.9	34.6	33.5	28.8	-	88
96	-	-	-	-	-	58.1	56.9	54.7	43.3	38.1	35.0	33.4	31.5	30.8	27.0	-	96
104	-	-	-	-	-	47.3	50.8	48.6	40.9	34.8	31.9	30.3	28.8	28.3	25.1	-	104
112	-	-	-	-	-	-	45.2	42.9	38.9	32.0	29.2	27.7	26.3	25.9	23.3	-	112
120	-	-	-	-	-	-	36.2	38.2	36.9	29.4	27.4	25.6	24.2	23.6	21.4	-	120
128	-	-	-	-	-	-	19.6	34.2	35.0	27.7	25.8	23.8	22.3	21.6	19.5	-	128
136	-	-	-	-	-	-	-	29.7	32.1	26.2	24.3	22.2	20.5	19.6	17.8	-	136
144	-	-	-	-	-	-	-	15.5	28.8	25.0	23.0	20.8	19.0	17.9	16.2	-	144
152	-	-	-	-	-	-	-	-	23.1	24.0	21.7	19.4	17.7	16.4	14.6	-	152
160	-	-	-	-	-	-	-	-	15.3	23.4	20.6	18.2	16.3	15.1	13.2	-	160
168	-	-	-	-	-	-	-	-	-	12.2	19.7	17.1	15.1	14.0	12.0	-	168
176	-	-	-	-	-	-	-	-	-	11.4	18.9	16.0	14.0	12.7	11.0	-	176
184	-	-	-	-	-	-	-	-	-	-	11.6	15.2	13.1	11.6	9.9	-	184
192	-	-	-	-	-	-	-	-	-	-	-	13.9	12.1	10.6	8.9	-	192
200	-	-	-	-	-	-	-	-	-	-	-	10.8	11.2	9.7	8.1	-	200
208	-	-	-	-	-	-	-	-	-	-	-	-	7.6	10.1	8.7	7.3	208
216	-	-	-	-	-	-	-	-	-	-	-	-	7.1	8.9	8.0	6.4	216
224	-	-	-	-	-	-	-	-	-	-	-	-	-	7.4	5.8	5.8	224
232	-	-	-	-	-	-	-	-	-	-	-	-	-	-	5.1	5.1	232
240	-	-	-	-	-	-	-	-	-	-	-	-	-	-	4.4	4.4	240

 109,800 lb		 28.5 ft x 27.8 ft											360°		85%		
		(ft)															
ft		47.6	64.0	80.1	96.5	112.5	128.9	145.0	161.4	177.5	193.9	210.0	226.4	242.5	262.5	ft	
		1,000 lb															
10	88.2	88.2	-	-	-	-	-	-	-	-	-	-	-	-	-	-	10
12	88.2	88.2	88.2	-	-	-	-	-	-	-	-	-	-	-	-	-	12
14	88.2	88.2	88.2	88.2	-	-	-	-	-	-	-	-	-	-	-	-	14
16	88.2	88.2	88.2	88.2	-	-	-	-	-	-	-	-	-	-	-	-	16
18	88.2	88.2	88.2	88.2	88.2	-	-	-	-	-	-	-	-	-	-	-	18
20	88.2	88.2	88.2	88.2	88.2	88.2	-	-	-	-	-	-	-	-	-	-	20
24	88.2	88.2	88.2	88.2	88.2	88.2	88.2	-	-	-	-	-	-	-	-	-	24
28	88.2	88.2	88.2	88.2	88.2	88.2	88.2	88.2	-	-	-	-	-	-	-	-	28
32	88.2	88.2	88.2	88.2	88.2	88.2	88.2	88.2	88.2	-	-	-	-	-	-	-	32
36	88.2	88.2	88.2	88.2	88.2	88.2	88.2	88.2	88.2	-	-	-	-	-	-	-	36
40	86.9	88.2	88.2	88.2	88.2	88.2	88.2	88.2	87.7	83.1	-	-	-	-	-	-	40
48	-	87.9	88.2	88.0	87.6	88.2	87.4	80.8	74.6	65.8	-	-	-	-	-	-	48
56	-	79.3	80.3	79.7	80.3	80.2	77.5	71.0	66.1	59.9	54.2	46.8	-	-	-	-	56
64	-	-	65.5	67.4	66.5	64.6	61.9	59.9	57.7	53.7	49.9	44.6	39.7	-	-	-	64
72	-	-	55.6	55.8	54.7	52.7	52.2	51.9	48.9	47.1	45.3	41.5	38.2	31.1	-	-	72
80	-	-	-	46.9	46.0	44.1	45.5	43.4	41.1	41.0	39.7	38.0	36.0	30.4	-	-	80
88	-	-	-	40.1	39.1	39.9	39.0	37.2	37.1	36.4	35.6	33.8	33.2	28.8	-	-	88
96	-	-	-	-	35.1	35.3	33.5	33.1	32.2	32.1	31.5	30.2	28.7	27.0	-	-	96
104	-	-	-	-	31.8	30.7	29.8	29.6	29.4	28.6	27.5	25.7	25.0	23.6	-	-	104
112	-	-	-	-	-	26.7	26.8	25.6	25.6	24.9	23.6	21.6	21.6	19.6	-	-	112
120	-	-	-	-	-	23.5	24.2	23.3	22.4	21.5	20.2	18.3	18.3	16.3	-	-	120
128	-	-	-	-	-	19.6	21.1	20.9	20.0	18.6	17.2	15.3	15.3	13.4	-	-	128
136	-	-	-	-	-	-	18.6	18.4	17.5	16.0	14.7	12.7	12.7	10.9	-	-	136
144	-	-	-	-	-	-	15.5	16.4	15.3	13.8	12.4	10.5	10.5	8.7	-	-	144
152	-	-	-	-	-	-	-	14.5	13.4	11.9	10.4	8.6	8.6	6.8	-	-	152
160	-	-	-	-	-	-	-	12.7	11.6	10.1	8.8	6.8	6.8	5.0	-	-	160
168	-	-	-	-	-	-	-	-	10.1	8.6	7.2	5.3	5.3	-	-	-	168
176	-	-	-	-	-	-	-	-	8.8	7.3	5.7	3.9	3.9	-	-	-	176
184	-	-	-	-	-	-	-	-	-	6.0	4.6	-	-	-	-	-	184

Ratings are in compliance with ASME B30.5.
Lifting capacities do not exceed 85 % of tipping load.

Weight of hook blocks and slings is part of the load, and is to be deducted from the capacity ratings.
Consult operation manual for further details.

Note: Data published herein is intended as a guide only and shall not be construed to warrant applicability for lifting purposes.
Crane operation is subject to the computer charts and operation manual both supplied with the crane.

Basic machine

Equipment carrier

Engine 430-4	MTU 6R1500; Diesel engine; Output 430 kW / 1700 1/min (577 HP), torque 2750 Nm / 1300 1/min; The engine complies with Euromot 4/Tier 4F; Exhaust system complete stainless steel with SCR catalyzer.
Fuel tank	Fuel tank 132 gallons Diesel (no RME / biodiesel); 25 gallons AdBlue tank.
Transmission AS16INT	ZF AS-Tronic; Automated gearbox with integrated hydraulic secondary retarder brake, 16 forward speeds and 2 reverse; 2-stage transfer case with switchable off-road gear.
Axles 12 x 6 x 10	12 x 6 x 10; 6 axles, axles 3, 5 and 6 are driven and dispose of selectable transverse lock; Axle 5 with a selectable longitudinal lock; Axles 1-3 and 5-6 are steered; Axle 4 liftable.
Suspension	Hydropneumatic suspension with axle load compensation; Hydraulically lockable.
Steering	Dual-circuit steering system with independent rear axle steering; Axles 1, 2, 3 mechanically connected; Axle 5 and 6 electro-hydraulically connected; Active rear axle steering with different steering programs.
Brakes	Pneumatic dual circuit service brake, acting on all wheels; Disc brakes; Hydraulic retarder integrated into transmission as wearless, sustained-action brake; Additional exhaust brake; Parking brake.
Tire size 385/95R25 (14.00R25)	Tires size 385/95R25 (14.00R25); Steel rim 9,5-25/1,7"; TechKing ETCRANE 170F or similar.
Cab 2850	Type 9.4 ft; Adjustable driver seat; Armrests and pneumatic suspension; Co-driver's seat; Steering wheel height and tilt adjustable; Power windows; Tinted glass; Power mirrors with heater; Preparation for radio.
Heating engine-dependent	Engine-dependent warm water heating with 12 kW heating power.
Drive lights	Including low beams, high beams, daytime running lights.
Outriggers	H-4-Point design; Vertical and horizontal movement fully hydraulic; Automatic or manual levelling; 5 outrigger bases: 9.0 ft, 13.2 ft, 18.1 ft, 22.9 ft and 27.8 ft.
Outrigger pads 038PA	4 round polyamide outrigger pads A = 1.25 ft ² with transport position at vertical cylinder.
Outrigger basis monitoring	Individual monitoring of horizontal stroke; Deviation warning in cab.
Outrigger load indicator	The outrigger load is indicated in the operator cab and the outrigger control box.
Electronic immobilizer system	Prevents uncontrolled carrier mobilization; Incl. 5 ignition keys.
Pneumatic tire filling plug	Pneumatic tire filling plug for self-inflating of the wheels.
Contour safety marking	Continuous reflective strips on the sides of the chassis and in the back.

Equipment superstructure

Telescopic boom HA80	47.6 ft - 262.5 ft; Single cylinder telescoping system, automatic telescoping; Attachments for all equipment and extensions; 4 sheaves integrated in boom head for max. capacity of 189,600 lb.
Boom luffing	1 luffing cylinder with automatic lowering brake valve.
Rotary drive	1 slewing gear unit with spring-loaded multi-disc brake.
H1	Hoist with spring-loaded multi-disc brake; Resolver (hoist rotation indicator); Rope twist prevention is not included.
Counterweight 109,800 lb	Counterweight 109,800 lb, 5 pieces (SPECIAL 6 pieces); Automatic rigging system.
Control system	Enabling 4 simultaneous working movements; Electric pilot controls via 2 two-axis joysticks; Different control modes selectable for hydraulic circuits.
Operator aids	IC-1, with integrated load moment indicator acc. EN13000; Colour display; Displaying of current operating conditions, load charts, fault indicator; Signal lights indicating LMI-load; Crane data logger.
Hook height indication	Displaying and programmability of the hook height H1 and /or H2 by IC-1.
Cab 875	Type 2.87 ft; Infinitely tilt variable 16°; Sliding windows rear; Fold-out front window; Extendable side pedestal, front pedestal; Handrails; Tinted safety glass; Pull-down sun visor; Preparation for radio.
Heating engine-independent	Engine independent warm water heating with 5 kW heating power.
Anemometer	Disconnectable, to allow use with all extensions.

Additional equipment

Carrier

Engine 430-ECE R96	MTU 6R1500; Diesel engine; Output 430 kW / 1700 1/min (577 HP), torque 2750 Nm / 1300 1/min; The engine complies with ECE R96; Exhaust system complete stainless steel.
Axles 12 x 8 x 12	12 x 8 x 12; 6 axles, axles 2, 3, 5 and 6 are driven and equipped with selectable transverse lock; Axle 5 with a selectable longitudinal lock; All axles are steered.
Additional fuel tank	Additional fuel tank 53 gallons; For 185 gallons diesel total carrier (no RME / biodiesel).
Aircondition	Aircondition for carrier cab with 7 kW rated cooling power.

Superstructure

Quick connection main boom (HA)	Hydraulic bolt extractors and hydraulic and electric quick couplings for fast main boom (dis-) assembly; Incl. switchable suspension calibration for light travel configurations without main boom; Incl. storage space for luffing cylinder.
Additional sheave on main boom head	1 additional sheave; Dis-/connectable; For total 5 sheaves on boom head; Max. capacity of 236,900 lb.
Heavy lift attachment	2 additional sheaves; Dis-/connectable; For total 7 sheaves at boom head; Max. capacity of 330,700 lb.
2. hoist (H2)	2. hoist; Spring-loaded multi-disc brake; Integrated resolver (hoist rotation indicator); Incl. quick couplings.
Additional counterweight 97,000 lb	Additional counterweight 97,000 lb; 4 pieces; For total 206,800 lb, 9 pieces (SPECIAL 10 pieces).
Aircondition	Aircondition for crane cab with 5 kW rated cooling power.

Handling

Remote control	Control of rigging and superstructure operations via wireless remote control.
Working range limiter	Displaying and programmability of the work range limits by IC-1.
IC-1 Plus	Smart crane control system for main boom operation enabling higher lifting capacities especially over outriggers. Enables safe use of the full capacity of the crane even in asymmetric outrigger configurations. Outriggers can be positioned independently. Capacity precalculation for +/- 30° slewing angle and radius area. In-cab lift simulation.

Extensions

HAV 36.1 ft	36.1 ft; Lattice swing-away jib, manual offset 20° / 40°; 1-sheave head; Incl. transport storage; Not transportable with 26,500 lb axle load limit.
HAV 68.9 ft	68.9 ft; Double folding swing-away jib, manual offset 20° / 40°; 1-sheave head; Incl. transport storage; Not transportable with 26,500 lb axle load limit; Includes HAV 36.1 ft.
HAV-HY	Hydraulic offset (0°-40°) instead of manual offset (20° / 40°); Available for HAV 36.1 ft and HAV 68.9 ft.
MS (runner)	5.25 ft; Assembly jib with fixed angle; 2-sheaved for max. capacity 88,200 lb; Incl. transport storage at the left side of main boom; Not transportable within 9.8 ft crane width.

Hook Blocks

Hook block 160-7-23-D-1700	160-7-23-D (3,750 lb); Hook block with ramshorn hook; with white red signal stripes.
Hook block 125-5-23-D-1200	125-5-23-D (2,650 lb); Hook block with ramshorn hook; with white red signal stripes.
Hook block 80-3-23-D-1050	80-3-23-D (2,320 lb); Hook block with ramshorn hook; with white red signal stripes.
Hook block 40-1-24-D-750	40-1-24-D (1,650 lb); Hook block with ramshorn hook; white with red signal stripes.
Hook 12.5-0-24-E-500	12.5-0-24-E (1,100 lb); Single hook; red.

Further additional equipment on request!

Weight data may deviate from posted values based on road / travel configuration, equipment configuration, and component weight tolerances.

A large rectangular area with horizontal lines, intended for taking notes.

A large rectangular area with horizontal lines, intended for taking notes.

October 2017. Product specifications and prices are subject to change without notice or obligation. The photographs and/or drawings in this document are for illustrative purposes only. Refer to the appropriate Operator's Manual for instructions on the proper use of this equipment. Failure to follow the corresponding Operator's Manual when using our equipment or to otherwise act responsibly may result in serious injury or death. The only warranty applicable to our equipment is the standard written warranty applicable to the particular product and sale and Terex makes no other warranty, express or implied. Products and services listed may be trademarks, service marks or trade-names of Terex Corporation and/or its subsidiaries in the USA and other countries. All rights are reserved. Terex, Demag and Above, Ahead, Always are trademarks of or licensed by Terex Corporation or its subsidiaries.

© Terex Cranes 2017

TEREX CRANES GERMANY GMBH

Dinglerstraße 24
66482 Zweibrücken
Germany

E info.cranes@terex.com
T +49 6332 830

www.terex.com/cranes
linkedin.com/company/demagmobilecranes
facebook.com/TerexCranes
youtube.com/TerexCranesMarketing

DEMAG[®]
BY TEREX 

Courtesy of Crane.Market