

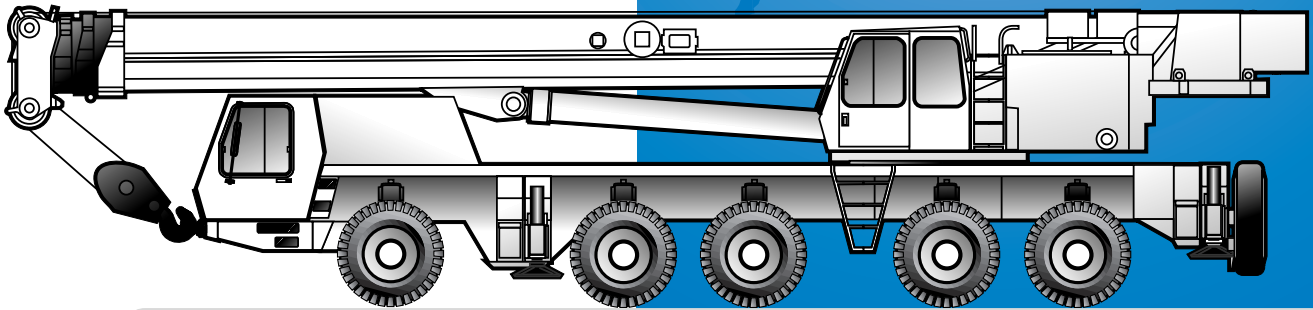

GROVE[®]
CRANE

A GROVE WORLDWIDE COMPANY

GMK5150B



All Terrain Hydraulic Crane

Dimensions

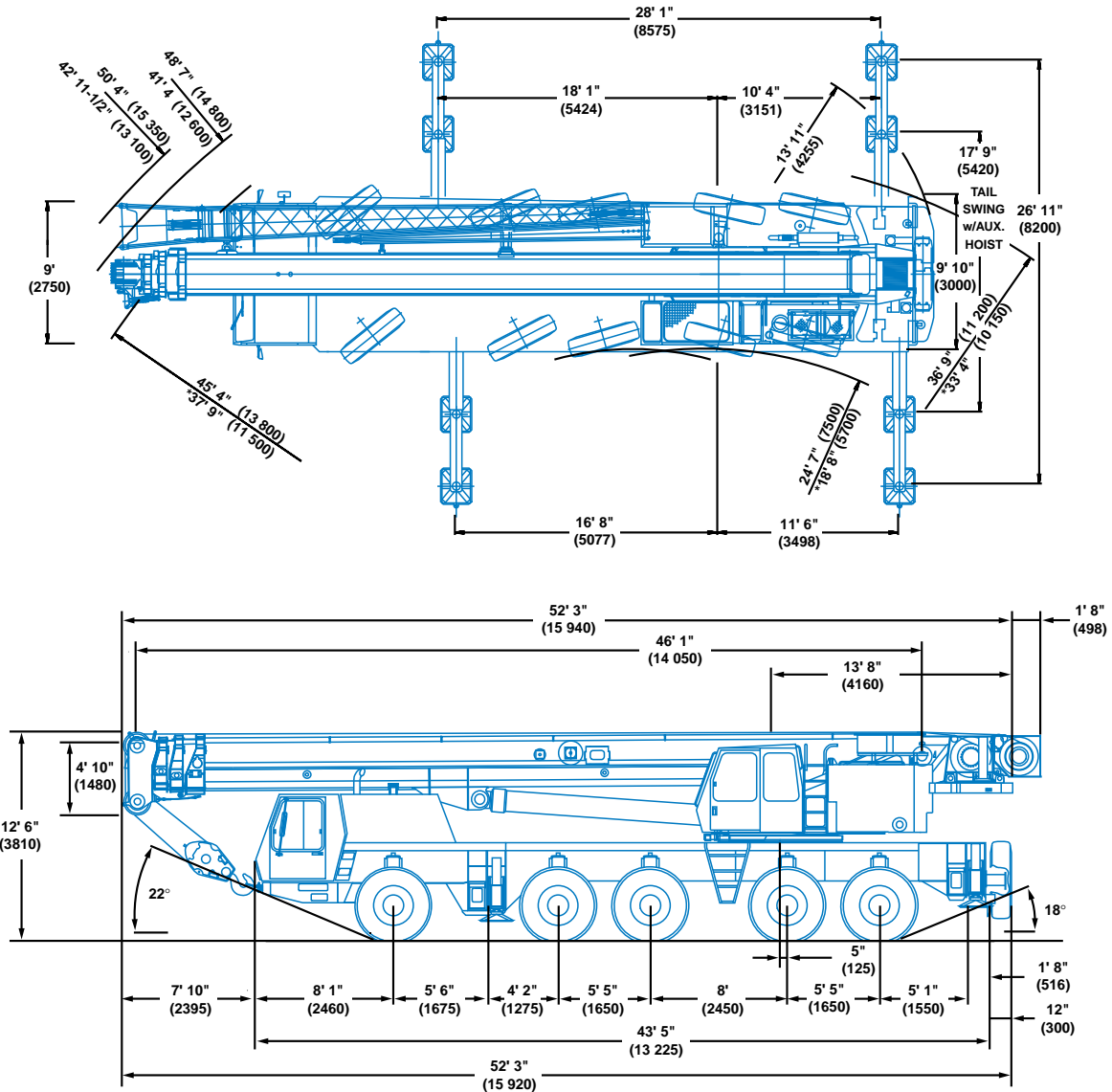

Model GMK 5150B equipped with:

10 x 6 x 10 drive/steer, 20.5 x 25 tires, hydraulic oil cooler, main hoist with cable (less all counterweight, hook blocks, outrigger floats and lattice extension).

Axles 1, 2 & 3

77,135 lbs.

Axles 4 & 5

40,505 lbs.

Total

117,640 lbs.

Weights for accessory equipment:

	Axles 1, 2 & 3	Axles 4 & 5	Total
1. Outrigger floats stowed	+ 139	+ 258	+ 397
2. Brackets for lattice extension to stow on base boom	+ 285	- 65	+ 220
3. Lattice extension - 33/53 ft.	+ 3,479	- 944	+ 2,535
4. 10 x 8 drive	- 48	+ 919	+ 871
5. Rooster sheave	+ 320	- 180	+ 140
6. 16.00R25 tires in lieu of 20.5R25	- 555	- 370	- 925
7. 14.00R25 tires in lieu of 20.5R25	- 1,350	- 900	- 2,250
8. Bracket for spare tire	- 30	+ 85	+ 55
9. Spare tire - 14.00R25	- 295	+ 825	+ 530
10. Spare tire - 16.00R25	- 380	+ 1,040	+ 660
11. Spare tire - 20.5R25	- 435	+ 1,190	+ 755
12. Auxiliary hoist	- 1,640	+ 4,290	+ 2,650
13. Remove rear outrigger beams/jacks	+ 2,395	- 7,795	- 5,400
14. Remove front outrigger beams/jacks	- 5,165	+ 705	- 4,460

Working Range



46-151 ft.
(14.0-46.0 m)

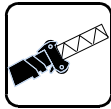

33-131 ft.
(10.0-39.9 m)

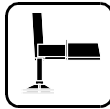

360°

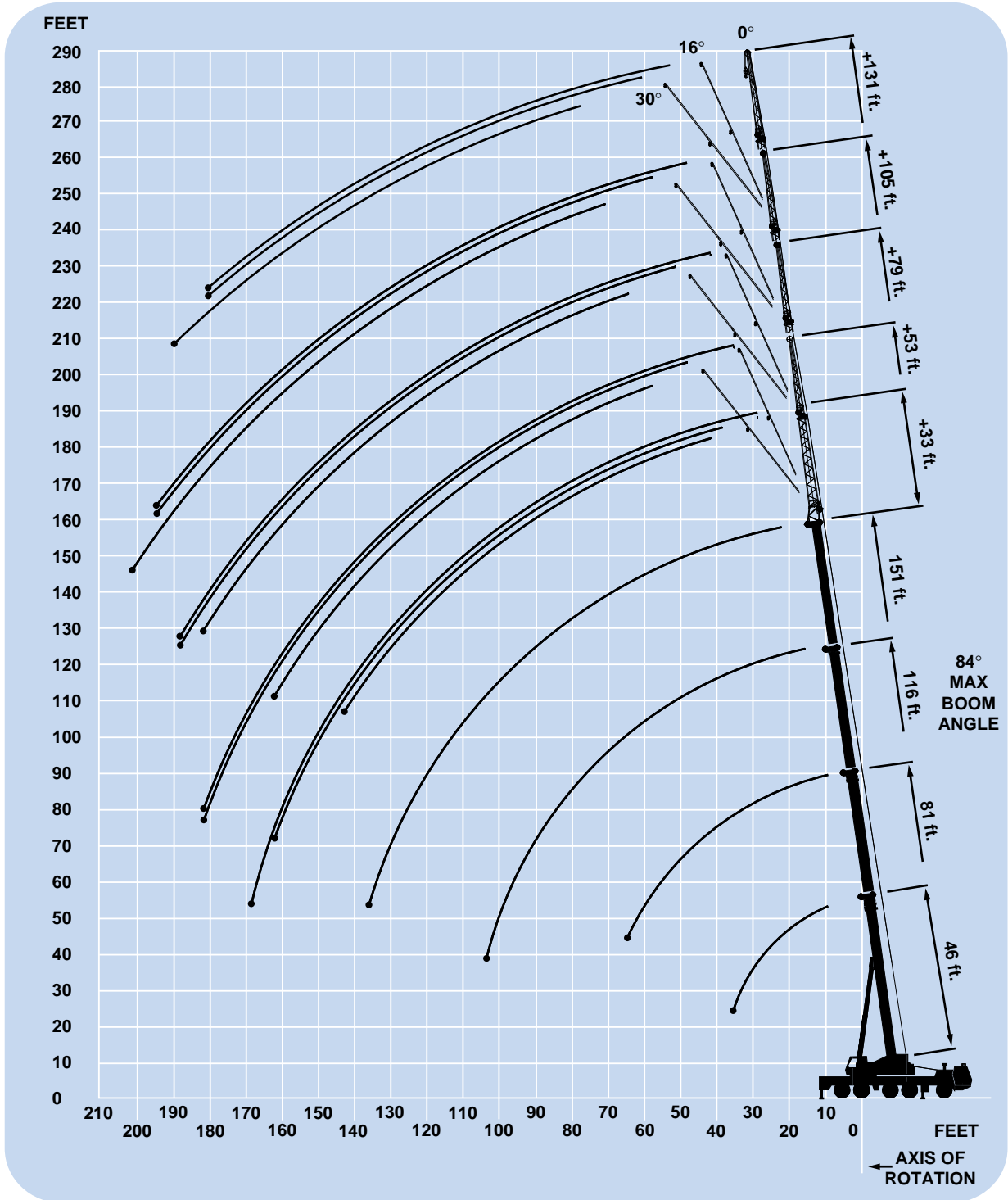

7'-0"

9'-7"

DIMENSIONS ARE FOR LARGEST GROVE FURNISHED HOOKBLOCK AND HEADACHE BALL, WITH ANTI-TWO BLOCK ACTIVATED.

Superstructure specifications

Boom

46 ft. to 151 ft. (14.0 m to 46.0 m) four-section full power boom.

Maximum tip height: 161 ft. (49.0 m)

Lattice Extension

Two-stage, 33 ft. to 53 ft. (10.0 m to 16.0 m) lattice extension offsettable at 0°, 16° and 30°. Stows alongside base boom section.

Maximum tip height: 213 ft. (65.0 m)

*Optional Lattice Extension

53 ft. (16.0 m) base section combines with three 26 ft. (7.92 m) inserts for lengths of 79, 105 and 131 ft. (24.0, 32.0 and 40.0 m). All three lengths offset at 0°, 16° and 30°.

Maximum tip height: 290 ft. (88.4 m)

Boom Elevation

Single cylinder with integral holding valves provides elevation from -3° to 84°.

Load Moment & Anti-Two Block System

Load moment and anti-two block system with audio-visual warning and control lever lock-out. These systems provide electronic display of boom angle, length, radius, tip height, relative load moment, maximum permissible load, load indication and warning of impending two-block condition.

Cab

Full vision aluminum cab, mounted on left-hand side of turntable, safety glass windows, hinged skylight window with windshield wiper, door with sliding windows, sun visor and roller blind, engine hot water heater, fan and defroster. Seat with hydraulic suspension and neck support, adjustable armrest. Ergonomically arranged instrumentation and operating controls for crane and engine.

Swing

Two bent axis piston motors with planetary gear and holding brake. Swing speed infinitely variable from 0 to 1.8 RPM.

Counterweight

Total of 59,500 lbs. (27 000 kg). Hydraulic installation/removal of all counterweight pieces. Cylinders for counterweight assembly at the turntable.

Engine

Mercedes Benz OM 366 A diesel, 6 cylinders, water-cooled, 139 hp (104 kW) @ 1800 RPM. Maximum torque: 417 ft. lbs. @ 1,500 - 1,600 RPM.

Fuel Tank Capacity

52.8 gallons (200 L).

HYDRAULIC SYSTEM

Three separate circuits in open circuit arrangement, comprising one axial piston variable displacement double pump with cumulative flow control and one triple fixed displacement gear pump. Hydraulic oil cooler. 291 gallons (1100 L tank capacity reservoir.)

Control System

All crane movements infinitely variable by hydraulic pilot control through armrest-integrated crane control levers with automatic reset to zero.

Electrical System

Two batteries: 12 V/170 Ah each

Generator: 28 V/55 A

HOIST SPECIFICATIONS

Main Hoist

Axial piston motor with planetary gear and automatic multiple disk brake. Drum rotation indicator.

Single line pull:	15,700 lbs. (7100 kg)
Single line speed:	394 FPM (120 m/min)
Rope diameter:	3/4 in. (19 mm)
Rope length:	787 ft. (240 m)

*Optional Auxiliary Hoist

Axial piston motor with planetary gear and automatic multiple disk brake. Drum rotation indicator.

Single line pull:	15,700 lbs. (7100 kg)
Single line speed:	394 FPM (120 m/min)
Rope diameter:	3/4 in. (19 mm)
Rope length:	590 ft. (180 m)

**Denotes optional equipment*

Carrier specifications

Chassis

Five-axle, all-welded torsion-resistant box-type construction of high strength steel.

Outriggers

Four hydraulically telescoping beam outriggers with vertical cylinders and outrigger pads. Independent horizontal and vertical movement control on each side of chassis. Crane level indicators for leveling control.

Engine

Mercedes Benz OM 442 LA diesel, 8 cylinders, water-cooled, with turbocharger and supercharger intercooler, 496 hp (370 kW) @ 2100 RPM. Maximum torque: 2,020 ft. lbs. @ 1,100 - 1,600 RPM

Fuel Tank Capacity

105 gallons (400 L).

Transmission

Allison automatic powershift transmission with 5 forward and 1 reverse gear. Two speed Kessler transfer case with longitudinal differential lock.

Drive

10 x 6 x 10

Axles

1st axle line - steer.

2nd axle line - drive/steer.

3rd axle line - drive/steer.

4th axle line - steer (off road only).

5th axle line - drive/steer.

Suspension

Exclusive "MEGATRAK™" independent hydropneumatic suspension and hydraulic axle lock-out. Level regulation. Suspension range: +6.7 in. (170 mm) to -4.97 in. (-126 mm). Automatic suspension level control by proximity switches.

Tires

10 - 20.5 x 25 radials.

Steering

Dual-circuit hydraulic power-assisted steering. Automatic switch-in of stand-by steering pump in case of main pump failure.

Brakes

Service brake: pneumatic dual circuit acting on all wheels. Air dryer. Parking brake: pneumatically operated spring-loaded brake acting on 2nd, 3rd, 4th and 5th axle lines. Auxiliary brake: hydraulic retarder integrated with automatic transmission.

Cab

Aluminum, two-man design, safety glass, laminated front windshield, windshield wipers/washers, defroster nozzle, lockable doors with sliding windows, driver's seat with hydraulic suspension, engine hot water heater, heatable rear view mirrors. Complete operating and driving controls. Stereo radio/cassette. Cab can be tilted forward by 60° for easy access to engine, transmission, hydraulic pumps, heater and batteries.

Electrical System

24 V lighting system and signals. Generator: 28 V/55 A. Two batteries: 12 V/170 Ah each.

Maximum Speed

46 mph (74 km/h)

Gradeability (Theoretical)

50%

Gross Vehicle Weight (Approximate)

117,640 lbs. (53 360 kg) see page 2.

Miscellaneous Standard Equipment

Hydraulic oil cooler; spare tire and wheel - 20.5R25 with carry bracket; spare parts/service manuals; flashing amber warning light on carrier cab; working light, tool kit, wheel chocks, fire extinguisher; rooster sheave.

Special Equipment to Dismantle Crane for Travel

*Boom float kit for boom dolly operation including electric and air line plugs at rear of carrier frame (less dolly).

*Hydraulic quick disconnect fittings for removal of outriggers beams and jacks.

Optional Equipment

*10 x 8 x 10 drive

*Hookblocks and headache balls

*14.00R25 tires

*16.00R25 tires



46 - 151 ft.
(14.0 - 46.0 m)



59,600 lbs.
(27 000 kg)



100%



360°



85% Domestic (Pounds)

(Feet)	46	64	81	99	116	133	151
9	*300,000						
10	288,000	218,000	136,000				
15	220,000	199,000	131,000	85,000			
20	174,000	166,000	111,000	85,000	71,000	53,000	
25	133,000	130,000	95,000	83,000	67,000	53,000	41,200
30	105,000	103,000	85,000	75,000	64,000	53,000	41,200
35	87,000	85,000	85,000	65,000	60,000	53,000	41,200
40		76,000	73,000	58,000	54,000	51,000	41,200
45		63,000	60,000	52,000	49,000	46,000	38,800
50		53,000	50,000	49,000	43,800	41,600	36,400
55			43,000	44,000	39,600	37,800	34,200
60			37,200	38,600	36,600	34,600	32,000
65			35,000	33,600	34,400	31,600	30,000
70				29,600	30,600	29,200	27,800
75				26,400	27,000	25,600	25,800
80				24,800	24,000	23,400	23,400
85				23,400	21,400	22,200	20,800
90					19,000	20,000	18,600
95					17,400	18,000	16,400
100					16,400	16,000	14,600
105						14,400	13,000
110						13,000	11,400
115						11,600	10,200
120							9,000
125							7,800
130							6,800
135							6,000

*Defined Arc/Over Rear Only

Lifting Capacities > 242,500 lbs. require additional equipment.

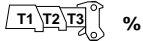

	T1	T2	T3	%
T1	0	50/0	100/50/0	100/50/0
T2	0	0/25	0/25/50	25/50/75
T3	0	0/25	0/25/50	25/50/75

Note: All Main Boom Charts available with 50% Outriggers.



46 - 151 ft.
(14.0 - 46.0 m)



46,700 lbs.
(21 200 kg)



100%



360°



85% Domestic (Pounds)

(Feet)	46	64	81	99	116	133	151
9	*300,000						
10	286,000	218,000	136,000				
15	220,000	199,000	131,000	85,000			
20	166,000	163,000	111,000	85,000	71,000	53,000	
25	126,000	123,000	95,000	83,000	67,000	53,000	41,200
30	100,000	97,000	85,000	75,000	64,000	53,000	41,200
35	81,000	85,000	82,000	65,000	60,000	53,000	41,200
40		68,000	65,000	58,000	54,000	51,000	41,200
45		56,000	53,000	52,000	49,000	46,000	38,800
50		47,000	45,000	46,000	43,800	41,600	36,400
55			40,000	39,200	39,200	37,800	34,200
60			36,200	33,800	34,800	33,400	32,000
65			31,600	29,800	30,400	28,800	29,800
70				28,200	26,400	26,400	25,800
75				25,200	23,000	24,000	22,400
80				22,400	20,800	21,200	19,600
85				19,800	19,400	18,800	17,200
90					18,200	16,600	15,000
95					16,400	14,600	13,200
100					14,800	13,000	11,600
105						11,600	10,000
110						10,200	8,800
115						9,000	7,600
120							6,400
125							5,400
130							4,600
135							3,800

*Defined Arc/Over Rear Only

Lifting Capacities > 242,500 lbs. require additional equipment

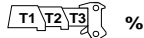

%

T1	0	50/0	100/50/0	100/50/0	100/50/0	100/50	100
T2	0	0/25	0/25/50	25/50/75	50/75/100	75/100	100
T3	0	0/25	0/25/50	25/50/75	50/75/100	75/100	100



46 - 151 ft.
(14.0 - 46.0 m)



28,000 lbs.
(12 700 kg)



100%



360°



85% Domestic (Pounds)

(Feet)	46	64	81	99	116	133	151
9	*300,000						
10	286,000	218,000	136,000				
15	220,000	199,000	131,000	85,000			
20	153,000	150,000	111,000	85,000	71,000	53,000	
25	116,000	113,000	95,000	83,000	67,000	53,000	41,200
30	88,000	85,000	85,000	75,000	64,000	53,000	41,200
35	67,000	70,000	67,000	65,000	60,000	53,000	41,200
40		56,000	53,000	55,000	53,000	51,000	41,200
45		46,000	47,000	45,000	45,000	43,600	38,800
50		37,800	39,200	37,800	37,800	36,400	36,400
55			33,000	34,000	31,600	32,600	31,000
60			28,200	29,000	27,000	27,800	26,000
65			24,000	25,000	25,200	23,800	22,000
70				21,600	22,200	20,400	18,800
75				18,800	19,400	17,600	16,000
80				16,400	17,000	15,200	13,600
85				14,200	14,800	13,200	11,600
90					13,000	11,400	9,800
95					11,400	9,800	8,200
100					10,000	8,400	7,000
105						7,200	5,600
110						6,000	4,600
115						5,000	3,600
120							2,800
125							2,000

*Defined Arc/Over Rear Only

Lifting Capacities > 242,500 lbs. require additional equipment

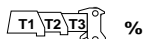

%

T1	0	50/0	100/50/0	100/50/0	100/50/0	100/50	100
T2	0	0/25	0/25/50	25/50/75	50/75/100	75/100	100
T3	0	0/25	0/25/50	25/50/75	50/75/100	75/100	100

THIS CHART IS ONLY A GUIDE AND SHOULD NOT BE USED TO OPERATE THE CRANE. The individual crane's load chart, operating instructions and other instructional plates must be read and understood prior to operating the crane.



46 - 151 ft.
(14.0 - 46.0 m)



9,300 lbs.
(4200 kg)



100%



360°



85% Domestic (Pounds)

(Feet)	46	64	81	99	116	133	151
10	286,000	218,000	136,000				
15	204,000	199,000	131,000	85,000			
20	140,000	137,000	111,000	85,000	71,000	53,000	
25	102,000	97,000	88,000	83,000	67,000	53,000	41,200
30	70,000	74,000	70,000	64,000	62,000	53,000	41,200
35	52,000	55,000	54,000	53,000	52,000	47,000	41,200
40		42,400	44,000	45,000	41,600	41,000	37,400
45		33,600	35,200	36,200	35,000	34,000	30,600
50		27,000	28,600	29,600	30,400	28,400	25,200
55			23,600	24,600	25,200	23,200	21,000
60			19,600	20,400	21,200	19,200	17,400
65			16,200	17,200	17,800	16,000	14,200
70				14,600	15,200	13,200	11,600
75				12,200	12,800	11,000	9,400
80				10,400	11,000	9,200	7,600
85				8,800	9,200	7,600	6,000
90					7,800	6,000	4,600
95					6,600	4,800	3,200
100					5,400	3,600	2,000
105						2,600	

*Defined Arc/Over Rear Only

Lifting Capacities > 242,500 lbs. require additional equipment

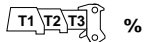

T1 T2 T3 %	46	64	81	99	116	133	151
T1	0	50/0	100/50/0	100/50/0	100/50/0	100/50	100
T2	0	0/25	0/25/50	25/50/75	50/75/100	75/100	100
T3	0	0/25	0/25/50	25/50/75	50/75/100	75/100	100



46 - 151 ft.
(14.0 - 46.0 m)



0 lbs.
(0 kg)



100%



360°



85% Domestic (Pounds)

(Feet)	46	64	81	99	116	133	151
10	286,000	218,000	136,000				
15	195,000	161,000	131,000	85,000			
20	121,000	99,000	85,000	78,000	71,000	53,000	
25	84,000	78,000	65,000	62,000	57,000	53,000	41,200
30	60,000	57,000	54,000	51,000	47,000	41,400	36,200
35	42,400	44,000	42,400	40,400	38,200	33,200	28,600
40		35,000	34,000	32,600	31,200	26,800	23,000
45		27,200	27,800	27,000	26,000	22,000	18,400
50		21,400	23,000	22,400	21,800	18,000	14,600
55			18,600	18,800	18,200	14,600	11,600
60			15,200	15,600	15,200	11,800	9,000
65			12,200	13,000	12,800	9,600	6,800
70				10,600	10,600	7,600	5,000
75				8,600	8,800	6,000	3,400
80				6,800	7,400	4,600	2,200
85				5,400	6,000	3,200	
90					4,600	2,200	
95					3,600		
100					2,600		
105							

*Defined Arc/Over Rear Only

Lifting Capacities > 242,500 lbs. require additional equipment

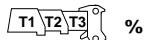

T1 T2 T3 %	46	64	81	99	116	133	151
T1	0	50/0	100/50/0	100/50/0	100/50/0	100/50	100
T2	0	0/25	0/25/50	25/50/75	50/75/100	75/100	100
T3	0	0/25	0/25/50	25/50/75	50/75/100	75/100	100



99 - 151 ft.
(30.0 - 46.0 m)



33 ft.
(10.0 m)



59,600 lbs.
(27 000 kg)



100%



360°



85% Domestic (Pounds)

(Feet)	33' - 0° LATTICE EXT.				33' - 16° LATTICE EXT.				33' - 30° LATTICE EXT.			
	99	116	133	151	99	116	133	151	99	116	133	151
20	30,800											
25	29,400	28,600										
30	26,800	27,000	24,000	20,600	19,200	19,600						
35	24,600	25,200	23,800	20,600	18,200	18,400	18,400		14,200			
40	22,600	23,400	23,200	20,600	17,000	17,600	17,600	17,200	13,600	13,800	13,800	
45	21,000	21,800	22,000	20,600	16,200	16,600	16,800	16,600	13,200	13,400	13,400	13,200
50	19,400	20,600	20,800	20,000	15,000	16,000	16,200	16,000	12,600	13,000	13,000	13,000
55	18,200	19,400	19,800	19,400	14,000	15,200	15,400	15,400	12,200	12,600	12,800	12,600
60	17,200	18,200	18,800	18,600	13,400	14,400	14,600	14,600	11,800	12,200	12,400	12,400
65	16,000	17,200	17,800	18,000	12,800	13,600	13,800	14,000	11,400	11,800	12,000	12,000
70	15,200	16,200	17,000	17,200	12,400	13,000	13,400	13,600	11,200	11,600	11,800	11,800
75	14,200	15,400	16,400	16,600	12,000	12,600	13,000	13,200	10,800	11,200	11,600	11,600
80	13,200	14,400	15,600	16,000	11,400	12,000	12,600	12,800	10,600	11,000	11,200	11,400
85	12,600	13,600	14,800	15,200	11,000	11,800	12,200	12,400	10,400	10,800	11,000	11,200
90	12,000	13,200	14,200	14,600	10,800	11,400	11,800	12,000	10,200	10,400	10,800	11,000
95	11,400	12,600	13,400	14,000	10,400	11,000	11,400	11,800	10,000	10,200	10,600	10,800
100	11,000	12,000	12,800	13,400	10,000	10,800	11,200	11,400	9,800	10,000	10,400	10,600
105	10,600	11,600	12,400	13,000	10,000	10,400	11,000	11,200		10,000	10,200	10,400
110	10,200	11,200	12,000	12,600	9,800	10,200	10,800	11,000		10,000	10,000	10,200
115	9,800	10,800	11,400	11,600	9,800	10,000	10,400	10,800		9,800	10,000	10,200
120		10,400	10,200	10,400		9,800	10,200	10,600			9,800	10,000
125		10,000	9,000	9,400		9,600	9,400	9,800			9,600	9,800
130		9,600	8,000	8,400		9,400	8,400	8,800			8,600	9,000
135			7,000	7,400			7,400	7,800				8,000
140			6,200	6,600			6,400	7,000				7,200
145			5,400	5,800			5,600	6,000				
150			4,600	5,000			4,800	5,200				
155				4,400				4,600				
160				3,600				3,800				
165				3,200								
170				2,600								
	%											
T1	100/0	100/0	100	100	100/0	100/0	100	100	100/0	100/0	100	100
T2	25/75	50/100	75	100	25/75	50/100	75	100	25/75	50/100	75	100
T3	25/75	50/100	75	100	25/75	50/100	75	100	25/75	50/100	75	100

THIS CHART IS ONLY A GUIDE AND SHOULD NOT BE USED TO OPERATE THE CRANE. The individual crane's load chart, operating instructions and other instructional plates must be read and understood prior to operating the crane.



99 - 151 ft.
(30.0 - 46.0 m)



53 ft.
(16.0 m)



59,600 lbs.
(27 000 kg)



100%



360°



85% Domestic (Pounds)

(Feet)	53' - 0° LATTICE EXT.				53' - 16° LATTICE EXT.				53' - 30° LATTICE EXT.			
	99	116	133	151	99	116	133	151	99	116	133	151
25	15,400											
30	15,400	15,400	14,800									
35	15,400	15,400	14,600									
40	14,800	15,200	14,000	13,400	10,800	11,000						
45	13,400	14,000	13,600	13,000	10,200	10,400	10,400					
50	12,600	13,000	13,200	12,600	9,800	10,000	10,000	10,000	8,200	8,400		
55	11,800	12,400	12,600	12,200	9,200	9,600	9,600	9,600	7,800	8,000	8,000	
60	11,000	11,600	12,000	11,800	8,800	9,200	9,200	9,400	7,600	7,800	7,800	7,800
65	10,400	11,000	11,400	11,400	8,400	8,800	9,000	9,000	7,400	7,600	7,600	7,600
70	9,800	10,400	10,800	11,000	8,000	8,400	8,600	8,800	7,200	7,400	7,400	7,400
75	9,400	10,000	10,400	10,600	7,800	8,200	8,400	8,400	6,800	7,200	7,200	7,200
80	8,800	9,400	9,800	10,000	7,400	7,800	8,000	8,200	6,600	7,000	7,000	7,200
85	8,400	9,000	9,400	9,800	7,200	7,600	7,800	8,000	6,400	6,800	6,800	7,000
90	8,000	8,600	9,200	9,400	7,000	7,400	7,600	7,800	6,400	6,600	6,800	6,800
95	7,600	8,200	8,800	9,000	6,800	7,000	7,400	7,400	6,200	6,400	6,600	6,600
100	7,400	8,000	8,400	8,800	6,400	6,800	7,200	7,200	6,000	6,200	6,400	6,600
105	7,000	7,600	8,200	8,400	6,400	6,600	7,000	7,200	6,000	6,200	6,400	6,400
110	6,800	7,400	7,800	8,200	6,200	6,600	6,800	7,000	5,800	6,000	6,200	6,400
115	6,600	7,200	7,600	8,000	6,000	6,400	6,600	6,800	5,800	6,000	6,000	6,200
120	6,400	7,000	7,400	7,600	5,800	6,200	6,400	6,600	5,800	5,800	6,000	6,000
125	6,000	6,600	7,000	7,400	5,800	6,000	6,200	6,400		5,800	5,800	6,000
130	5,800	6,400	6,800	7,200	5,600	5,800	6,200	6,400		5,600	5,800	5,800
135	5,600	6,200	6,600	7,000	5,600	5,800	6,000	6,200		5,600	5,800	5,800
140		6,000	6,400	6,800		5,800	6,000	6,000			5,800	5,800
145		5,800	6,200	6,600		5,600	5,800	6,000			5,600	5,800
150		5,800	6,000	6,200		5,600	5,800	5,800			5,600	5,600
155			5,400	5,400			5,600	5,800				5,600
160			4,600	4,800			5,000	5,400				5,600
165			4,000	4,200			4,400	4,600				
170			3,600	3,600			3,800	4,000				
175				3,200				3,400				
180				2,600				3,000				
185				2,200								
	T1 T2 T3 %											
T1	100/0	100/0	100	100	100/0	100/0	100	100	100/0	100/0	100	100
T2	25/75	50/100	75	100	25/75	50/100	100	100	25/75	50/100	75	100
T3	25/75	50/100	75	100	25/75	50/100	100	100	25/75	50/100	75	100

THIS CHART IS ONLY A GUIDE AND SHOULD NOT BE USED TO OPERATE THE CRANE. The individual crane's load chart, operating instructions and other instructional plates must be read and understood prior to operating the crane.



99 - 151 ft.
(30.0 - 46.0 m)



79 ft.
(24.0 m)



59,600 lbs.
(27 000 kg)



100%



360°



85% Domestic (Pounds)

(Feet)	79' - 0° LATTICE EXT.				79' - 16° LATTICE EXT.				79' - 30° LATTICE EXT.			
	99	116	133	151	99	116	133	151	99	116	133	151
30	14,800											
35	14,600	13,800										
40	14,600	13,600	11,800		10,600							
45	14,000	13,600	11,800	10,000	10,200							
50	13,200	13,200	11,800	10,000	9,800	9,800	9,600		8,000			
55	12,600	12,600	11,800	10,000	9,400	9,600	9,400	9,200	7,600	7,800		
60	12,000	12,000	11,600	10,000	9,000	9,200	9,000	9,000	7,400	7,800	7,600	
65	11,400	11,600	11,200	10,000	8,600	9,000	8,800	9,000	7,200	7,600	7,400	
70	10,800	11,000	11,000	10,000	8,400	8,600	8,600	8,800	7,000	7,400	7,200	7,400
75	10,400	10,600	10,600	10,000	8,000	8,400	8,400	8,600	7,000	7,200	7,000	7,200
80	9,800	10,200	10,200	9,800	7,800	8,200	8,000	8,400	6,800	7,000	6,800	7,200
85	9,400	9,800	9,800	9,600	7,600	8,000	7,800	8,200	6,600	7,000	6,800	7,000
90	9,000	9,400	9,600	9,400	7,400	7,800	7,600	8,000	6,400	6,800	6,600	7,000
95	8,600	9,000	9,200	9,200	7,200	7,600	7,400	7,800	6,400	6,600	6,400	6,800
100	8,200	8,600	9,000	9,000	7,000	7,400	7,200	7,600	6,200	6,600	6,400	6,600
105	8,000	8,400	8,600	8,800	6,800	7,200	7,200	7,400	6,200	6,400	6,400	6,600
110	7,600	8,000	8,400	8,400	6,600	7,000	7,000	7,400	6,000	6,400	6,200	6,600
115	7,400	7,800	8,000	8,200	6,400	6,800	6,800	7,200	6,000	6,400	6,200	6,400
120	7,000	7,600	7,800	8,000	6,400	6,800	6,800	7,000	5,800	6,200	6,000	6,400
125	6,800	7,200	7,600	7,800	6,200	6,600	6,600	7,000	5,800	6,200	6,000	6,200
130	6,400	7,000	7,200	7,400	6,000	6,400	6,400	6,800	5,600	6,000	5,800	6,200
135	6,200	6,800	7,000	7,200	6,000	6,200	6,400	6,600	5,600	6,000	5,800	6,200
140	6,000	6,600	6,800	7,000	5,800	6,200	6,200	6,600	5,600	5,800	5,800	6,000
145	5,800	6,400	6,600	7,000	5,600	6,000	6,200	6,400		5,800	5,800	6,000
150	5,600	6,200	6,400	6,800	5,600	5,800	6,000	6,200		5,600	5,600	6,000
155	5,600	6,000	6,000	6,000	5,400	5,600	6,000	6,200		5,600	5,600	6,000
160	5,400	5,600	5,400	5,400		5,600	5,800	6,000			5,600	5,800
165		5,600	4,800	4,800		5,400	5,400	5,400			5,600	5,800
170		5,400	4,200	4,200		5,200	4,600	4,800			5,000	5,000
175		5,200	3,600	3,600		5,200	4,200	4,200				4,400
180			3,200	3,200			3,600	3,600				3,800
185			2,800	2,600			3,000	3,200				
190			2,200	2,200			2,600	2,600				
195							2,200					
 %												
T1	100/0	100/0	100	100	100/0	100/0	100	100	100/0	100/0	100	100
T2	25/75	50/100	100	100	25/75	50/100	100	100	25/75	50/100	75	100
T3	25/75	50/100	100	100	25/75	50/100	100	100	25/75	50/100	75	100

THIS CHART IS ONLY A GUIDE AND SHOULD NOT BE USED TO OPERATE THE CRANE. The individual crane's load chart, operating instructions and other instructional plates must be read and understood prior to operating the crane.



99 - 151 ft.
(30.0 - 46.0 m)



105 ft.
(32.0 m)



59,600 lbs.
(27 000 kg)



100%



360°



85% Domestic (Pounds)

(Feet)	105' - 0° LATTICE EXT.				105' - 16° LATTICE EXT.				105' - 30° LATTICE EXT.			
	99	116	133	151	99	116	133	151	99	116	133	151
35	10,800											
40	10,400	10,200										
45	10,000	9,800	8,600									
50	9,800	9,400	8,600	7,000	9,400	8,800						
55	9,400	9,200	8,600	7,000	9,000	8,600	8,000					
60	9,000	8,800	8,200	7,000	8,600	8,200	7,800	7,000	7,400			
65	8,600	8,400	8,000	7,000	8,200	7,800	7,400	7,000	7,400			
70	8,200	8,200	7,800	7,000	7,800	7,600	7,200	6,800	7,200	7,200	7,000	
75	7,800	7,800	7,400	7,000	7,400	7,200	7,000	6,600	6,800	7,000	6,800	6,400
80	7,400	7,400	7,200	6,800	7,000	7,000	6,800	6,400	6,600	6,800	6,600	6,200
85	7,200	7,200	7,000	6,600	6,800	6,800	6,600	6,200	6,400	6,400	6,400	6,000
90	6,800	6,800	6,800	6,400	6,400	6,400	6,400	6,000	6,200	6,200	6,200	5,800
95	6,400	6,600	6,600	6,200	6,200	6,200	6,200	5,800	5,800	6,000	6,000	5,600
100	6,200	6,400	6,200	6,000	5,800	6,000	6,000	5,800	5,600	5,800	5,800	5,600
105	6,000	6,200	6,200	6,000	5,600	5,800	5,800	5,600	5,400	5,600	5,600	5,400
110	5,600	6,000	6,000	5,800	5,400	5,600	5,600	5,400	5,200	5,400	5,400	5,200
115	5,400	5,800	5,800	5,600	5,200	5,400	5,400	5,400	5,000	5,200	5,200	5,200
120	5,200	5,400	5,600	5,400	5,000	5,200	5,200	5,200	4,800	5,000	5,200	5,000
125	5,000	5,200	5,400	5,200	4,800	5,000	5,000	5,000	4,600	4,800	5,000	5,000
130	4,600	5,000	5,200	5,200	4,600	4,800	5,000	4,800	4,400	4,600	4,800	4,800
135	4,400	4,800	5,000	5,000	4,400	4,600	4,800	4,800	4,400	4,600	4,600	4,600
140	4,400	4,600	4,800	4,800	4,200	4,400	4,600	4,600	4,200	4,400	4,600	4,600
145	4,200	4,400	4,800	4,800	4,200	4,400	4,600	4,600	4,000	4,200	4,400	4,400
150	4,000	4,400	4,600	4,600	4,000	4,200	4,400	4,400	3,800	4,200	4,400	4,400
155	3,800	4,200	4,400	4,400	3,800	4,000	4,200	4,400	3,800	4,000	4,200	4,200
160	3,600	4,000	4,200	4,400	3,600	3,800	4,000	4,200	3,600	3,800	4,000	4,200
165	3,600	3,800	4,000	4,200	3,600	3,800	4,000	4,200	3,400	3,800	4,000	4,000
170	3,400	3,800	4,000	4,200	3,400	3,600	3,800	4,000	3,400	3,600	3,800	4,000
175	3,400	3,600	3,800	4,000	3,400	3,600	3,800	4,000		3,600	3,800	3,800
180	3,200	3,600	3,600	3,600	3,200	3,400	3,600	3,800		3,400	3,600	3,800
185		3,400	3,200	3,000		3,400	3,600	3,600			3,600	3,600
190		3,200	2,800	2,600		3,200	3,200	3,000			3,400	3,400
195		3,200	2,200	2,200		3,200	2,600	2,600			2,800	2,800
200		3,000	1,800				2,200	2,200				2,400
205												2,000
T1 T2 T3 %												
T1	100/0	100/0	100	100	100/0	100/0	100	100	100/0	100/0	100	100
T2	25/75	50/100	100	100	25/75	50/100	100	100	25/75	50/100	100	100
T3	25/75	50/100	100	100	25/75	50/100	100	100	25/75	50/100	100	100

THIS CHART IS ONLY A GUIDE AND SHOULD NOT BE USED TO OPERATE THE CRANE. The individual crane's load chart, operating instructions and other instructional plates must be read and understood prior to operating the crane.



99 - 151 ft.
(30.0 - 46.0 m)



131 ft.
(40.0 m)



59,600 lbs.
(27 000 kg)



100%



360°



85% Domestic (Pounds)

(Feet)	131' - 0° LATTICE EXT.				131' - 16° LATTICE EXT.				131' - 30° LATTICE EXT.			
	99	116	133	151	99	116	133	151	99	116	133	151
40	6,400	6,600										
45	6,400	6,400	5,800									
50	6,400	6,200	5,800	4,800	6,600							
55	6,200	6,000	5,600	4,800	6,200	5,800						
60	6,000	5,800	5,400	4,800	6,000	5,800	4,800					
65	5,800	5,800	5,200	4,800	5,800	5,600	4,800					
70	5,600	5,600	5,200	4,600	5,600	5,400	4,800	4,600	5,600	5,400		
75	5,400	5,400	5,000	4,600	5,400	5,200	4,800	4,400	5,200	5,000	4,800	
80	5,200	5,200	4,800	4,400	5,000	5,000	4,600	4,200	5,000	4,800	4,600	4,200
85	5,000	5,000	4,600	4,200	4,800	4,800	4,400	4,200	4,800	4,600	4,400	4,000
90	4,800	4,800	4,600	4,200	4,600	4,600	4,400	4,000	4,600	4,400	4,200	4,000
95	4,400	4,400	4,400	4,000	4,400	4,400	4,200	3,800	4,400	4,400	4,200	3,800
100	4,200	4,200	4,200	3,800	4,200	4,200	4,000	3,800	4,200	4,200	4,000	3,800
105	4,000	4,200	4,000	3,800	4,000	4,000	3,800	3,600	4,000	4,000	3,800	3,600
110	4,000	4,000	4,000	3,600	3,800	3,800	3,800	3,600	3,800	3,800	3,800	3,600
115	3,800	3,800	3,800	3,600	3,600	3,800	3,600	3,400	3,600	3,600	3,600	3,400
120	3,600	3,600	3,600	3,400	3,400	3,600	3,400	3,400	3,400	3,600	3,400	3,200
125	3,400	3,400	3,400	3,400	3,400	3,400	3,400	3,200	3,400	3,400	3,400	3,200
130	3,200	3,200	3,200	3,200	3,200	3,200	3,200	3,200	3,200	3,200	3,200	3,000
135	3,000	3,200	3,200	3,000	3,000	3,200	3,200	3,000	3,000	3,200	3,200	3,000
140	3,000	3,000	3,000	3,000	2,800	3,000	3,000	3,000	3,000	3,000	3,000	3,000
145	2,800	3,000	3,000	2,800	2,800	2,800	3,000	2,800	2,800	2,800	3,000	2,800
150	2,600	2,800	2,800	2,800	2,600	2,800	2,800	2,800	2,600	2,800	2,800	2,800
155	2,400	2,600	2,800	2,800	2,400	2,600	2,600	2,600	2,600	2,600	2,800	2,600
160	2,400	2,400	2,600	2,600	2,400	2,600	2,600	2,600	2,400	2,600	2,600	2,600
165	2,200	2,400	2,400	2,600	2,200	2,400	2,400	2,400	2,200	2,400	2,600	2,400
170	2,000	2,200	2,400	2,400	2,200	2,200	2,400	2,400	2,200	2,400	2,400	2,400
175		2,200	2,200	2,400		2,200	2,200	2,400	2,000	2,200	2,400	2,400
180		2,000	2,200	2,200		2,000	2,200	2,200		2,200	2,200	2,200
185				2,200				2,200			2,200	2,200
190											2,200	2,200

	T1 T2 T3 %			T1 T2 T3 %			T1 T2 T3 %					
T1	100/0	100/0	100	100	100/0	100/0	100	100	100/0	100/0	100	100
T2	25/75	50/100	75	100	25/75	50/100	75	100	25/75	50/100	75	100
T3	25/75	50/100	75	100	25/75	50/100	75	100	25/75	50/100	75	100

THIS CHART IS ONLY A GUIDE AND SHOULD NOT BE USED TO OPERATE THE CRANE. The individual crane's load chart, operating instructions and other instructional plates must be read and understood prior to operating the crane.



99 - 151 ft.
(30.0 - 46.0 m)



33 ft.
(10.0 m)



46,700 lbs.
(21 200 kg)



100%



360°



85% Domestic (Pounds)

(Feet)	33' - 0° LATTICE EXT.				33' - 16° LATTICE EXT.				33' - 30° LATTICE EXT.			
	99	116	133	151	99	116	133	151	99	116	133	151
20	30,800											
25	29,400	28,600										
30	26,800	27,000	24,000	20,600	19,200	19,600						
35	24,600	25,200	23,800	20,600	18,200	18,400	18,400		14,200			
40	22,600	23,400	23,200	20,600	17,000	17,600	17,600	17,200	13,600	13,800	13,800	
45	21,000	21,800	22,000	20,600	16,200	16,600	16,800	16,600	13,200	13,400	13,400	13,200
50	19,400	20,600	20,800	20,000	15,000	16,000	16,200	16,000	12,600	13,000	13,000	13,000
55	18,200	19,400	19,800	19,400	14,000	15,200	15,400	15,400	12,200	12,600	12,800	12,600
60	17,200	18,200	18,800	18,600	13,400	14,400	14,600	14,600	11,800	12,200	12,400	12,400
65	16,000	17,200	17,800	18,000	12,800	13,600	13,800	14,000	11,400	11,800	12,000	12,000
70	15,200	16,200	17,000	17,200	12,400	13,000	13,400	13,600	11,200	11,600	11,800	11,800
75	14,200	15,400	16,400	16,600	12,000	12,600	13,000	13,200	10,800	11,200	11,600	11,600
80	13,200	14,400	15,600	16,000	11,400	12,000	12,600	12,800	10,600	11,000	11,200	11,400
85	12,600	13,600	14,800	15,200	11,000	11,800	12,200	12,400	10,400	10,800	11,000	11,200
90	12,000	13,200	14,200	14,600	10,800	11,400	11,800	12,000	10,200	10,400	10,800	11,000
95	11,400	12,600	13,400	14,000	10,400	11,000	11,400	11,800	10,000	10,200	10,600	10,800
100	11,000	12,000	12,800	13,200	10,000	10,800	11,200	11,400	9,800	10,000	10,400	10,600
105	10,600	11,400	11,200	11,600	10,000	10,400	11,000	11,200		10,000	10,200	10,400
110	10,200	11,200	10,000	10,200	9,800	10,200	10,600	11,000		10,000	10,000	10,200
115	9,800	10,800	8,800	9,000	9,800	10,000	9,200	9,800		9,800	9,600	10,200
120		10,400	7,600	8,000		9,800	8,200	8,600			8,400	9,000
125		10,000	6,600	7,000		9,600	7,000	7,600			7,400	7,800
130		9,400	5,800	6,000		9,400	6,200	6,600			6,200	6,800
135			4,800	5,200			5,200	5,600				5,800
140			4,200	4,400			4,400	4,800				5,000
145			3,400	3,800			3,600	4,000				
150			2,800	3,000			2,800	3,400				
155				2,400				2,600				
160				1,800				2,000				
T1	100/0	100/0	100	100	100/0	100/0	100	100	100/0	100/0	100	100
T2	25/75	50/100	75	100	25/75	50/100	75	100	25/75	50/100	75	100
T3	25/75	50/100	75	100	25/75	50/100	75	100	25/75	50/100	75	100

THIS CHART IS ONLY A GUIDE AND SHOULD NOT BE USED TO OPERATE THE CRANE. The individual crane's load chart, operating instructions and other instructional plates must be read and understood prior to operating the crane.



99 - 151 ft.
(30.0 - 46.0 m)



53 ft.
(16.0 m)



46,700 lbs.
(21 200 kg)



100%



360°



85% Domestic (Pounds)

(Feet)	53' - 0° LATTICE EXT.				53' - 16° LATTICE EXT.				53' - 30° LATTICE EXT.			
	99	116	133	151	99	116	133	151	99	116	133	151
25	15,400											
30	15,400	15,400	14,800									
35	15,400	15,400	14,600									
40	14,800	15,200	14,000	13,400	10,800	11,000						
45	13,400	14,000	13,600	13,000	10,200	10,400	10,400					
50	12,600	13,000	13,200	12,600	9,800	10,000	10,000	10,000	8,200	8,400		
55	11,800	12,400	12,600	12,200	9,200	9,600	9,600	9,600	7,800	8,000	8,000	
60	11,000	11,600	12,000	11,800	8,800	9,200	9,200	9,400	7,600	7,800	7,800	7,800
65	10,400	11,000	11,400	11,400	8,400	8,800	9,000	9,000	7,400	7,600	7,600	7,600
70	9,800	10,400	10,800	11,000	8,000	8,400	8,600	8,800	7,200	7,400	7,400	7,400
75	9,400	10,000	10,400	10,600	7,800	8,200	8,400	8,400	6,800	7,200	7,200	7,200
80	8,800	9,400	9,800	10,000	7,400	7,800	8,000	8,200	6,600	7,000	7,000	7,200
85	8,400	9,000	9,400	9,800	7,200	7,600	7,800	8,000	6,400	6,800	6,800	7,000
90	8,000	8,600	9,200	9,400	7,000	7,400	7,600	7,800	6,400	6,600	6,800	6,800
95	7,600	8,200	8,800	9,000	6,800	7,000	7,400	7,400	6,200	6,400	6,600	6,600
100	7,400	8,000	8,400	8,800	6,400	6,800	7,200	7,200	6,000	6,200	6,400	6,600
105	7,000	7,600	8,200	8,400	6,400	6,600	7,000	7,200	6,000	6,200	6,400	6,400
110	6,800	7,400	7,800	8,200	6,200	6,600	6,800	7,000	5,800	6,000	6,200	6,400
115	6,600	7,200	7,600	8,000	6,000	6,400	6,600	6,800	5,800	6,000	6,000	6,200
120	6,400	7,000	7,400	7,600	5,800	6,200	6,400	6,600	5,800	5,800	6,000	6,000
125	6,000	6,600	7,000	7,400	5,800	6,000	6,200	6,400		5,800	5,800	6,000
130	5,800	6,400	6,800	7,200	5,600	5,800	6,200	6,400		5,600	5,800	5,800
135	5,600	6,200	6,200	6,400	5,600	5,800	6,000	6,200		5,600	5,800	5,800
140		6,000	5,400	5,600		5,600	6,000	6,000			5,800	5,800
145		5,800	4,800	4,800		5,600	5,400	5,600			5,600	5,800
150		5,800	4,000	4,200		5,600	4,600	4,800			4,800	5,200
155			3,400	3,600			4,000	4,200				4,600
160			2,800	3,000			3,200	3,600				3,800
165			2,400	2,400			2,600	3,000				
170				2,000			2,000	2,400				
	%											
T1	100/0	100/0	100	100	100/0	100/0	100	100	100/0	100/0	100	100
T2	25/75	50/100	75	100	25/75	50/100	75	100	25/75	50/100	75	100
T3	25/75	50/100	75	100	25/75	50/100	75	100	25/75	50/100	75	100

THIS CHART IS ONLY A GUIDE AND SHOULD NOT BE USED TO OPERATE THE CRANE. The individual crane's load chart, operating instructions and other instructional plates must be read and understood prior to operating the crane.



99 - 151 ft.
(30.0 - 46.0 m)



79 ft.
(24.0 m)



46,700 lbs.
(21 200 kg)



100%



360°



85% Domestic (Pounds)

(Feet)	79' - 0° LATTICE EXT.				79' - 16° LATTICE EXT.				79' - 30° LATTICE EXT.			
	99	116	133	151	99	116	133	151	99	116	133	151
30	15,400											
35	15,000	13,800										
40	14,600	13,600	11,800		10,600							
45	14,000	13,600	11,800	10,000	10,200							
50	13,200	13,200	11,800	10,000	9,800	9,800	9,600		8,000			
55	12,600	12,600	11,800	10,000	9,400	9,600	9,400	9,200	7,600	7,800		
60	12,000	12,000	11,600	10,000	9,000	9,200	9,000	9,000	7,400	7,800	7,600	
65	11,400	11,600	11,200	10,000	8,600	9,000	8,800	9,000	7,200	7,600	7,400	
70	10,800	11,000	11,000	10,000	8,400	8,600	8,600	8,800	7,000	7,400	7,200	7,400
75	10,400	10,600	10,600	10,000	8,000	8,400	8,400	8,600	7,000	7,200	7,000	7,200
80	9,800	10,200	10,200	9,800	7,800	8,200	8,000	8,400	6,800	7,000	6,800	7,200
85	9,400	9,800	9,800	9,600	7,600	8,000	7,800	8,200	6,600	7,000	6,800	7,000
90	9,000	9,400	9,600	9,400	7,400	7,800	7,600	8,000	6,400	6,800	6,600	7,000
95	8,600	9,000	9,200	9,200	7,200	7,600	7,400	7,800	6,400	6,600	6,400	6,800
100	8,200	8,600	9,000	9,000	7,000	7,400	7,200	7,600	6,200	6,600	6,400	6,600
105	8,000	8,400	8,600	8,800	6,800	7,200	7,200	7,400	6,200	6,400	6,400	6,600
110	7,600	8,000	8,400	8,400	6,600	7,000	7,000	7,400	6,000	6,400	6,200	6,600
115	7,400	7,800	8,000	8,200	6,400	6,800	6,800	7,200	6,000	6,400	6,200	6,400
120	7,000	7,600	7,800	8,000	6,400	6,800	6,800	7,000	5,800	6,200	6,000	6,400
125	6,800	7,200	7,600	7,800	6,200	6,600	6,600	7,000	5,800	6,200	6,000	6,200
130	6,400	7,000	7,200	7,400	6,000	6,400	6,400	6,800	5,600	6,000	5,800	6,200
135	6,200	6,800	7,000	7,000	6,000	6,200	6,400	6,600	5,600	6,000	5,800	6,200
140	6,000	6,400	6,200	6,200	5,800	6,200	6,200	6,600	5,600	5,800	5,800	6,000
145	5,800	6,200	5,400	5,400	5,600	6,000	6,200	6,200		5,800	5,800	6,000
150	5,600	6,000	4,800	4,800	5,600	5,800	5,400	5,600		5,600	5,600	6,000
155	5,400	5,800	4,200	4,200	5,400	5,600	4,800	4,800		5,600	5,200	5,400
160	5,200	5,600	3,600	3,600		5,600	4,200	4,200			4,400	4,600
165		5,600	3,000	3,000		5,400	3,600	3,600			3,800	4,000
170		5,400	2,600	2,600		5,200	3,000	3,000			3,200	3,400
175		5,000	2,000	2,000		5,200	2,400	2,600				2,800
180							2,000	2,000				2,200
	%											
T1	100/0	100/0	100	100	100/0	100/0	100	100	100/0	100/0	100	100
T2	25/75	50/100	75	100	25/75	50/100	75	100	25/75	50/100	75	100
T3	25/75	50/100	75	100	25/75	50/100	75	100	25/75	50/100	75	100

THIS CHART IS ONLY A GUIDE AND SHOULD NOT BE USED TO OPERATE THE CRANE. The individual crane's load chart, operating instructions and other instructional plates must be read and understood prior to operating the crane.



99 - 151 ft.
(30.0 - 46.0 m)



105 ft.
(32.0 m)



46,700 lbs.
(21 200 kg)



100%



360°



85% Domestic (Pounds)

(Feet)	105' - 0° LATTICE EXT.				105' - 16° LATTICE EXT.				105' - 30° LATTICE EXT.			
	99	116	133	151	99	116	133	151	99	116	133	151
35	10,800											
40	10,400	10,200										
45	10,000	9,800	8,600									
50	9,800	9,400	8,600	7,000	9,400	8,800						
55	9,400	9,200	8,600	7,000	9,000	8,600	8,000					
60	9,000	8,800	8,200	7,000	8,600	8,200	7,800	7,000	7,400			
65	8,600	8,400	8,000	7,000	8,200	7,800	7,400	7,000	7,400			
70	8,200	8,200	7,800	7,000	7,800	7,600	7,200	6,800	7,200	7,200	7,000	
75	7,800	7,800	7,400	7,000	7,400	7,200	7,000	6,600	6,800	7,000	6,800	6,400
80	7,400	7,400	7,200	6,800	7,000	7,000	6,800	6,400	6,600	6,800	6,600	6,200
85	7,200	7,200	7,000	6,600	6,800	6,800	6,600	6,200	6,400	6,400	6,400	6,000
90	6,800	6,800	6,800	6,400	6,400	6,400	6,400	6,000	6,200	6,200	6,200	5,800
95	6,400	6,600	6,600	6,200	6,200	6,200	6,200	5,800	5,800	6,000	6,000	5,600
100	6,200	6,400	6,200	6,000	5,800	6,000	6,000	5,800	5,600	5,800	5,800	5,600
105	6,000	6,200	6,200	6,000	5,600	5,800	5,800	5,600	5,400	5,600	5,600	5,400
110	5,600	6,000	6,000	5,800	5,400	5,600	5,600	5,400	5,200	5,400	5,400	5,200
115	5,400	5,800	5,800	5,600	5,200	5,400	5,400	5,400	5,000	5,200	5,200	5,200
120	5,200	5,400	5,600	5,400	5,000	5,200	5,200	5,200	4,800	5,000	5,200	5,000
125	5,000	5,200	5,400	5,200	4,800	5,000	5,000	5,000	4,600	4,800	5,000	5,000
130	4,600	5,000	5,200	5,200	4,600	4,800	5,000	4,800	4,400	4,600	4,800	4,800
135	4,400	4,800	5,000	5,000	4,400	4,600	4,800	4,800	4,400	4,600	4,600	4,600
140	4,400	4,600	4,800	4,800	4,200	4,400	4,600	4,600	4,200	4,400	4,600	4,600
145	4,200	4,400	4,800	4,800	4,200	4,400	4,600	4,600	4,000	4,200	4,400	4,400
150	4,000	4,400	4,600	4,600	4,000	4,200	4,400	4,400	3,800	4,200	4,400	4,400
155	3,800	4,200	4,400	4,400	3,800	4,000	4,200	4,400	3,800	4,000	4,200	4,200
160	3,600	4,000	4,000	4,000	3,600	3,800	4,000	4,200	3,600	3,800	4,000	4,200
165	3,600	3,800	3,600	3,400	3,600	3,800	4,000	4,000	3,400	3,800	4,000	4,000
170	3,400	3,600	3,000	2,800	3,400	3,600	3,600	3,600	3,400	3,600	3,800	4,000
175	3,200	3,600	2,600	2,400	3,200	3,600	3,000	3,000		3,600	3,400	3,400
180	3,200	3,400	2,000	2,000	3,200	3,400	2,600	2,400		3,400	2,800	2,800
185		3,400				3,400	2,000	2,000			2,400	2,400
190		3,200				3,200						
195		3,200										
200		3,000										
	%											
T1	100/0	100/0	100	100	100/0	100/0	100	100	100/0	100/0	100	100
T2	25/75	50/100	75	100	25/75	50/100	75	100	25/75	50/100	75	100
T3	25/75	50/100	75	100	25/75	50/100	75	100	25/75	50/100	75	100

THIS CHART IS ONLY A GUIDE AND SHOULD NOT BE USED TO OPERATE THE CRANE. The individual crane's load chart, operating instructions and other instructional plates must be read and understood prior to operating the crane.



99 - 151 ft.
(30.0 - 46.0 m)



131 ft.
(40.0 m)



46,700 lbs.
(21 200 kg)



100%



360°



85% Domestic (Pounds)

(Feet)	131' - 0° LATTICE EXT.				131' - 16° LATTICE EXT.				131' - 30° LATTICE EXT.			
	99	116	133	151	99	116	133	151	99	116	133	151
40	6,400	6,600										
45	6,400	6,400	5,800									
50	6,400	6,200	5,800	4,800	6,600							
55	6,200	6,000	5,600	4,800	6,200	5,800						
60	6,000	5,800	5,400	4,800	6,000	5,800	4,800					
65	5,800	5,800	5,200	4,800	5,800	5,600	4,800					
70	5,600	5,600	5,200	4,600	5,600	5,400	4,800	4,600	5,600	5,400		
75	5,400	5,400	5,000	4,600	5,400	5,200	4,800	4,400	5,200	5,000	4,800	
80	5,200	5,200	4,800	4,400	5,000	5,000	4,600	4,200	5,000	4,800	4,600	4,200
85	5,000	5,000	4,600	4,200	4,800	4,800	4,400	4,200	4,800	4,600	4,400	4,000
90	4,800	4,800	4,600	4,200	4,600	4,600	4,400	4,000	4,600	4,400	4,200	4,000
95	4,400	4,400	4,400	4,000	4,400	4,400	4,200	3,800	4,400	4,400	4,200	3,800
100	4,200	4,200	4,200	3,800	4,200	4,200	4,000	3,800	4,200	4,200	4,000	3,800
105	4,000	4,200	4,000	3,800	4,000	4,000	3,800	3,600	4,000	4,000	3,800	3,600
110	4,000	4,000	4,000	3,600	3,800	3,800	3,800	3,600	3,800	3,800	3,800	3,600
115	3,800	3,800	3,800	3,600	3,600	3,800	3,600	3,400	3,600	3,600	3,600	3,400
120	3,600	3,600	3,600	3,400	3,400	3,600	3,400	3,400	3,400	3,600	3,400	3,200
125	3,400	3,400	3,400	3,400	3,400	3,400	3,400	3,200	3,400	3,400	3,400	3,200
130	3,200	3,200	3,200	3,200	3,200	3,200	3,200	3,200	3,200	3,200	3,200	3,000
135	3,000	3,200	3,200	3,000	3,000	3,200	3,200	3,000	3,000	3,200	3,200	3,000
140	3,000	3,000	3,000	3,000	2,800	3,000	3,000	3,000	3,000	3,000	3,000	3,000
145	2,800	3,000	3,000	2,800	2,800	2,800	3,000	2,800	2,800	2,800	3,000	2,800
150	2,600	2,800	2,800	2,800	2,600	2,800	2,800	2,800	2,600	2,800	2,800	2,800
155	2,400	2,600	2,800	2,800	2,400	2,600	2,600	2,600	2,600	2,600	2,800	2,600
160	2,400	2,400	2,600	2,600	2,400	2,600	2,600	2,600	2,400	2,600	2,600	2,600
165	2,200	2,400	2,400	2,600	2,200	2,400	2,400	2,400	2,200	2,400	2,600	2,400
170	2,000	2,200	2,400	2,400	2,200	2,200	2,400	2,400	2,200	2,400	2,400	2,400
175		2,200	2,200	2,400		2,200	2,200	2,400	2,000	2,200	2,400	2,400
180		2,000	2,200	2,000		2,000	2,200	2,200		2,200	2,200	2,200
185							2,200				2,200	2,200
190												2,200
	%											
T1	100/0	100/0	100	100	100/0	100/0	100	100	100/0	100/0	100	100
T2	25/75	50/100	75	100	25/75	50/100	75	100	25/75	50/100	75	100
T3	25/75	50/100	75	100	25/75	50/100	75	100	25/75	50/100	75	100

THIS CHART IS ONLY A GUIDE AND SHOULD NOT BE USED TO OPERATE THE CRANE. The individual crane's load chart, operating instructions and other instructional plates must be read and understood prior to operating the crane.



99 - 151 ft.
(30.0 - 46.0 m)



33 ft.
(10.0 m)



28,000 lbs.
(12 700 kg)



100%



360°



85% Domestic (Pounds)

(Feet)	33' - 0° LATTICE EXT.				33' - 16° LATTICE EXT.				33' - 30° LATTICE EXT.			
	99	116	133	151	99	116	133	151	99	116	133	151
20	30,800											
25	29,400	28,600										
30	26,800	27,000	24,000	20,600	19,200	19,600						
35	24,600	25,200	23,800	20,600	18,200	18,400	18,400		14,200			
40	22,600	23,400	23,200	20,600	17,000	17,600	17,600	17,200	13,600	13,800	13,800	
45	21,000	21,800	22,000	20,600	16,200	16,600	16,800	16,600	13,200	13,400	13,400	13,200
50	19,400	20,600	20,800	20,000	15,000	16,000	16,200	16,000	12,600	13,000	13,000	13,000
55	18,200	19,400	19,800	19,400	14,000	15,200	15,400	15,400	12,200	12,600	12,800	12,600
60	17,200	18,200	18,800	18,600	13,400	14,400	14,600	14,600	11,800	12,200	12,400	12,400
65	16,000	17,200	17,800	18,000	12,800	13,600	13,800	14,000	11,400	11,800	12,000	12,000
70	15,200	16,200	17,000	17,200	12,400	13,000	13,400	13,600	11,200	11,600	11,800	11,800
75	14,200	15,400	16,400	16,600	12,000	12,600	13,000	13,200	10,800	11,200	11,600	11,600
80	13,200	14,400	15,000	15,400	11,400	12,000	12,600	12,800	10,600	11,000	11,200	11,400
85	12,400	13,400	13,000	13,400	11,000	11,800	12,200	12,400	10,400	10,800	11,000	11,200
90	11,800	12,800	11,200	11,600	10,800	11,400	11,800	12,000	10,200	10,400	10,800	11,000
95	11,400	12,400	9,600	10,000	10,400	10,800	10,400	10,800	9,800	10,200	10,600	10,800
100	10,800	11,800	8,200	8,600	10,000	10,600	9,000	9,400	9,800	10,000	9,400	10,000
105	10,600	10,600	6,800	7,200	10,000	10,400	7,600	8,000		10,000	8,000	8,600
110	9,400	9,400	5,800	6,200	9,800	10,000	6,400	6,800		9,800	6,800	7,400
115	8,400	8,400	4,800	5,200	8,600	8,800	5,400	5,800		9,000	5,800	6,200
120		7,600	3,800	4,200		7,800	4,400	4,800			4,600	5,200
125		6,600	3,000	3,400		6,800	3,400	4,000			3,800	4,200
130		5,800	2,200	2,600		6,000	2,600	3,200			2,800	3,400
135				2,000			2,000	2,400				2,600
%												
T1	100/0	100/0	100	100	100/0	100/0	100	100	100/0	100/0	100	100
T2	25/75	50/100	75	100	25/75	50/100	75	100	25/75	50/100	75	100
T3	25/75	50/100	75	100	25/75	50/100	75	100	25/75	50/100	75	100

THIS CHART IS ONLY A GUIDE AND SHOULD NOT BE USED TO OPERATE THE CRANE. The individual crane's load chart, operating instructions and other instructional plates must be read and understood prior to operating the crane.



99 - 151 ft.
(30.0 - 46.0 m)



53 ft.
(16.0 m)



28,000 lbs.
(12 700 kg)



100%



360°



85% Domestic (Pounds)

(Feet)	53' - 0° LATTICE EXT.				53' - 16° LATTICE EXT.				53' - 30° LATTICE EXT.			
	99	116	133	151	99	116	133	151	99	116	133	151
20												
25	15,400											
30	15,400	15,400	14,800									
35	15,400	15,400	14,600									
40	14,800	15,200	14,000	13,400	10,800	11,000						
45	13,400	14,000	13,600	13,000	10,200	10,400	10,400					
50	12,600	13,000	13,200	12,600	9,800	10,000	10,000	10,000	8,200	8,400		
55	11,800	12,400	12,600	12,200	9,200	9,600	9,600	9,600	7,800	8,000	8,000	
60	11,000	11,600	12,000	11,800	8,800	9,200	9,200	9,400	7,600	7,800	7,800	7,800
65	10,400	11,000	11,400	11,400	8,400	8,800	9,000	9,000	7,400	7,600	7,600	7,600
70	9,800	10,400	10,800	11,000	8,000	8,400	8,600	8,800	7,200	7,400	7,400	7,400
75	9,400	10,000	10,400	10,600	7,800	8,200	8,400	8,400	6,800	7,200	7,200	7,200
80	8,800	9,400	9,800	10,000	7,400	7,800	8,000	8,200	6,600	7,000	7,000	7,200
85	8,400	9,000	9,400	9,800	7,200	7,600	7,800	8,000	6,400	6,800	6,800	7,000
90	8,000	8,600	9,200	9,400	7,000	7,400	7,600	7,800	6,400	6,600	6,800	6,800
95	7,600	8,200	8,800	9,000	6,800	7,000	7,400	7,400	6,200	6,400	6,600	6,600
100	7,400	8,000	8,400	8,800	6,400	6,800	7,200	7,200	6,000	6,200	6,400	6,600
105	7,000	7,600	8,200	8,400	6,400	6,600	7,000	7,200	6,000	6,200	6,400	6,400
110	6,800	7,400	7,200	7,400	6,200	6,600	6,800	7,000	5,800	6,000	6,200	6,400
115	6,600	7,000	6,200	6,400	6,000	6,400	6,600	6,800	5,800	6,000	6,000	6,200
120	6,200	6,800	5,200	5,400	5,800	6,200	6,200	6,600	5,800	5,800	6,000	6,000
125	6,000	6,600	4,400	4,600	5,800	6,000	5,400	5,600		5,800	5,800	6,000
130	5,800	6,400	3,600	3,800	5,600	5,800	4,600	4,800		5,600	5,000	5,400
135	5,600	6,200	3,000	3,200	5,600	5,800	3,800	4,000		5,600	4,200	4,600
140		5,600	2,400	2,400		5,600	3,000	3,200			3,400	3,800
145		5,000				5,400	2,400	2,600			2,600	3,000
150		4,400				4,600		2,000			2,000	2,400
155												
	%											
T1	100/0	100/0	100	100	100/0	100/0	100	100	100/0	100/0	100	100
T2	25/75	50/100	75	100	25/75	50/100	75	100	25/75	50/100	75	100
T3	25/75	50/100	75	100	25/75	50/100	75	100	25/75	50/100	75	100

THIS CHART IS ONLY A GUIDE AND SHOULD NOT BE USED TO OPERATE THE CRANE. The individual crane's load chart, operating instructions and other instructional plates must be read and understood prior to operating the crane.



99 - 151 ft.
(30.0 - 46.0 m)



79 ft.
(24.0 m)



28,000 lbs.
(12 700 kg)



100%



360°



85% Domestic (Pounds)

(Feet)	79' - 0° LATTICE EXT.				79' - 16° LATTICE EXT.				79' - 30° LATTICE EXT.			
	99	116	133	151	99	116	133	151	99	116	133	151
30	15,400											
35	15,000	13,800										
40	14,600	13,600	11,800		10,600							
45	14,000	13,600	11,800	10,000	10,200							
50	13,200	13,200	11,800	10,000	9,800	9,800	9,600		8,000			
55	12,600	12,600	11,800	10,000	9,400	9,600	9,400	9,200	7,600	7,800		
60	12,000	12,000	11,600	10,000	9,000	9,200	9,000	9,000	7,400	7,800	7,600	
65	11,400	11,600	11,200	10,000	8,600	9,000	8,800	9,000	7,200	7,600	7,400	
70	10,800	11,000	11,000	10,000	8,400	8,600	8,600	8,800	7,000	7,400	7,200	7,400
75	10,400	10,600	10,600	10,000	8,000	8,400	8,400	8,600	7,000	7,200	7,000	7,200
80	9,800	10,200	10,200	9,800	7,800	8,200	8,000	8,400	6,800	7,000	6,800	7,200
85	9,400	9,800	9,800	9,600	7,600	8,000	7,800	8,200	6,600	7,000	6,800	7,000
90	9,000	9,400	9,600	9,400	7,400	7,800	7,600	8,000	6,400	6,800	6,600	7,000
95	8,600	9,000	9,200	9,200	7,200	7,600	7,400	7,800	6,400	6,600	6,400	6,800
100	8,200	8,600	9,000	9,000	7,000	7,400	7,200	7,600	6,200	6,600	6,400	6,600
105	8,000	8,400	8,600	8,800	6,800	7,200	7,200	7,400	6,200	6,400	6,400	6,600
110	7,600	8,000	8,000	8,000	6,600	7,000	7,000	7,400	6,000	6,400	6,200	6,600
115	7,200	7,600	7,000	7,000	6,400	6,800	6,800	7,200	6,000	6,400	6,200	6,400
120	7,000	7,400	6,000	6,000	6,400	6,800	6,800	7,000	5,800	6,200	6,000	6,400
125	6,600	7,000	5,200	5,200	6,200	6,600	6,200	6,200	5,800	6,200	6,000	6,200
130	6,400	6,800	4,400	4,400	6,000	6,400	5,400	5,400	5,600	6,000	5,800	6,200
135	6,200	6,600	3,800	3,800	5,800	6,200	4,600	4,600	5,600	6,000	5,200	5,200
140	6,000	6,200	3,000	3,000	5,800	6,200	3,800	4,000	5,600	5,800	4,400	4,600
145	5,800	5,400	2,400	2,400	5,600	6,000	3,200	3,200		5,800	3,600	3,800
150	5,200	4,800	1,800		5,600	5,400	2,600	2,600		5,600	3,000	3,200
155	4,600	4,400			5,000	4,800	2,000	2,000		5,000	2,400	2,400
160	4,200	3,800				4,200						2,000
165		3,400				3,600						
170		3,000				3,200						
175		2,600				2,800						
T1	100/0	100/0	100	100	100/0	100/0	100	100	100/0	100/0	100	100
T2	25/75	50/100	75	100	25/75	50/100	75	100	25/75	50/100	75	100
T3	25/75	50/100	75	100	25/75	50/100	75	100	25/75	50/100	75	100

THIS CHART IS ONLY A GUIDE AND SHOULD NOT BE USED TO OPERATE THE CRANE. The individual crane's load chart, operating instructions and other instructional plates must be read and understood prior to operating the crane.



99 - 151 ft.
(30.0 - 46.0 m)



105 ft.
(32.0 m)



28,000 lbs.
(12 700 kg)



100%



360°



85% Domestic (Pounds)

(Feet)	105' - 0° LATTICE EXT.				105' - 16° LATTICE EXT.				105' - 30° LATTICE EXT.			
	99	116	133	151	99	116	133	151	99	116	133	151
35	10,800											
40	10,400	10,200										
45	10,000	9,800	8,600									
50	9,800	9,400	8,600	7,000	9,400	8,800						
55	9,400	9,200	8,600	7,000	9,000	8,600	8,000					
60	9,000	8,800	8,200	7,000	8,600	8,200	7,800	7,000	7,400			
65	8,600	8,400	8,000	7,000	8,200	7,800	7,400	7,000	7,400			
70	8,200	8,200	7,800	7,000	7,800	7,600	7,200	6,800	7,200	7,200	7,000	
75	7,800	7,800	7,400	7,000	7,400	7,200	7,000	6,600	6,800	7,000	6,800	6,400
80	7,400	7,400	7,200	6,800	7,000	7,000	6,800	6,400	6,600	6,800	6,600	6,200
85	7,200	7,200	7,000	6,600	6,800	6,800	6,600	6,200	6,400	6,400	6,400	6,000
90	6,800	6,800	6,800	6,400	6,400	6,400	6,400	6,000	6,200	6,200	6,200	5,800
95	6,400	6,600	6,600	6,200	6,200	6,200	6,200	5,800	5,800	6,000	6,000	5,600
100	6,200	6,400	6,200	6,000	5,800	6,000	6,000	5,800	5,600	5,800	5,800	5,600
105	6,000	6,200	6,200	6,000	5,600	5,800	5,800	5,600	5,400	5,600	5,600	5,400
110	5,600	6,000	6,000	5,800	5,400	5,600	5,600	5,400	5,200	5,400	5,400	5,200
115	5,400	5,800	5,800	5,600	5,200	5,400	5,400	5,400	5,000	5,200	5,200	5,200
120	5,200	5,400	5,600	5,400	5,000	5,200	5,200	5,200	4,800	5,000	5,200	5,000
125	5,000	5,200	5,400	5,200	4,800	5,000	5,000	5,000	4,600	4,800	5,000	5,000
130	4,600	5,000	5,000	4,800	4,600	4,800	5,000	4,800	4,400	4,600	4,800	4,800
135	4,400	4,800	4,200	4,200	4,400	4,600	4,800	4,800	4,400	4,600	4,600	4,600
140	4,200	4,600	3,600	3,400	4,200	4,400	4,400	4,400	4,200	4,400	4,600	4,600
145	4,200	4,400	3,000	2,800	4,000	4,200	3,800	3,600	4,000	4,200	4,400	4,200
150	4,000	4,200	2,400	2,200	3,800	4,200	3,200	3,000	3,800	4,000	3,600	3,600
155	3,800	4,000			3,800	4,000	2,600	2,400	3,800	4,000	3,000	3,000
160	3,600	4,000			3,600	3,800	2,000	2,000	3,600	3,800	2,400	2,400
165	3,400	3,600			3,400	3,800			3,400	3,800	1,800	
170	3,400	3,200			3,400	3,600			3,400	3,600		
175	3,200	2,800			3,200	3,200				3,400		
180	2,800	2,400			3,000	2,800				2,800		
185		2,000										
190						2,000						
 %												
T1	100/0	100/0	100	100	100/0	100/0	100	100	100/0	100/0	100	100
T2	25/75	50/100	75	100	25/75	50/100	75	100	25/75	50/100	75	100
T3	25/75	50/100	75	100	25/75	50/100	75	100	25/75	50/100	75	100

THIS CHART IS ONLY A GUIDE AND SHOULD NOT BE USED TO OPERATE THE CRANE. The individual crane's load chart, operating instructions and other instructional plates must be read and understood prior to operating the crane.



99 - 151 ft.
(30.0 - 46.0 m)



131 ft.
(40.0 m)



28,000 lbs.
(12 700 kg)



100%



360°



85% Domestic (Pounds)

(Feet)	131' - 0° LATTICE EXT.				131' - 16° LATTICE EXT.				131' - 30° LATTICE EXT.			
	99	116	133	151	99	116	133	151	99	116	133	151
40	6,400	6,600										
45	6,400	6,400	5,800									
50	6,400	6,200	5,800	4,800	6,600							
55	6,200	6,000	5,600	4,800	6,200	5,800						
60	6,000	5,800	5,400	4,800	6,000	5,800	4,800					
65	5,800	5,800	5,200	4,800	5,800	5,600	4,800					
70	5,600	5,600	5,200	4,600	5,600	5,400	4,800	4,600	5,600	5,400		
75	5,400	5,400	5,000	4,600	5,400	5,200	4,800	4,400	5,200	5,000	4,800	
80	5,200	5,200	4,800	4,400	5,000	5,000	4,600	4,200	5,000	4,800	4,600	4,200
85	5,000	5,000	4,600	4,200	4,800	4,800	4,400	4,200	4,800	4,600	4,400	4,000
90	4,800	4,800	4,600	4,200	4,600	4,600	4,400	4,000	4,600	4,400	4,200	4,000
95	4,400	4,400	4,400	4,000	4,400	4,400	4,200	3,800	4,400	4,400	4,200	3,800
100	4,200	4,200	4,200	3,800	4,200	4,200	4,000	3,800	4,200	4,200	4,000	3,800
105	4,000	4,200	4,000	3,800	4,000	4,000	3,800	3,600	4,000	4,000	3,800	3,600
110	4,000	4,000	4,000	3,600	3,800	3,800	3,800	3,600	3,800	3,800	3,800	3,600
115	3,800	3,800	3,800	3,600	3,600	3,800	3,600	3,400	3,600	3,600	3,600	3,400
120	3,600	3,600	3,600	3,400	3,400	3,600	3,400	3,400	3,400	3,600	3,400	3,200
125	3,400	3,400	3,400	3,400	3,400	3,400	3,400	3,200	3,400	3,400	3,400	3,200
130	3,200	3,200	3,200	3,200	3,200	3,200	3,200	3,200	3,200	3,200	3,200	3,000
135	3,000	3,200	3,200	3,000	3,000	3,200	3,200	3,000	3,000	3,200	3,200	3,000
140	3,000	3,000	3,000	3,000	2,800	3,000	3,000	3,000	3,000	3,000	3,000	3,000
145	2,800	3,000	3,000	2,800	2,800	2,800	3,000	2,800	2,800	2,800	3,000	2,800
150	2,600	2,800	2,600	2,400	2,600	2,800	2,800	2,800	2,600	2,800	2,800	2,800
155	2,400	2,600	2,200		2,400	2,600	2,600	2,600	2,600	2,600	2,800	2,600
160	2,400	2,400			2,400	2,600	2,400	2,200	2,400	2,600	2,600	2,600
165	2,200	2,400			2,200	2,400			2,200	2,400	2,200	2,200
170	2,000	2,200			2,200	2,200			2,200	2,200		
175		2,200				2,200			2,000	2,200		
180		2,000				2,000				2,200		
	%											
T1	100/0	100/0	100	100	100/0	100/0	100	100	100/0	100/0	100	100
T2	25/75	50/100	75	100	25/75	50/100	75	100	25/75	50/100	75	100
T3	25/75	50/100	75	100	25/75	50/100	75	100	25/75	50/100	75	100

THIS CHART IS ONLY A GUIDE AND SHOULD NOT BE USED TO OPERATE THE CRANE. The individual crane's load chart, operating instructions and other instructional plates must be read and understood prior to operating the crane.



99 - 151 ft.
(30.0 - 46.0 m)



33 ft.
(10.0 m)



9,300 lbs.
(4200 kg)



100%



360°



85% Domestic (Pounds)

(Feet)	33' - 0° LATTICE EXT.				33' - 16° LATTICE EXT.				33' - 30° LATTICE EXT.			
	99	116	133	151	99	116	133	151	99	116	133	151
20	30,800											
25	29,400	28,600										
30	26,800	27,000	24,000	20,600	19,200	19,600						
35	24,600	25,200	23,800	20,600	18,200	18,400	18,400		14,200			
40	22,600	23,400	23,200	20,600	17,000	17,600	17,600	17,200	13,600	13,800	13,800	
45	21,000	21,800	22,000	20,600	16,200	16,600	16,800	16,600	13,200	13,400	13,400	13,200
50	19,400	20,600	20,800	20,000	15,000	16,000	16,200	16,000	12,600	13,000	13,000	13,000
55	18,200	19,400	19,800	19,400	14,000	15,200	15,400	15,400	12,200	12,600	12,800	12,600
60	17,200	18,200	18,800	18,600	13,400	14,400	14,600	14,600	11,800	12,200	12,400	12,400
65	15,800	16,800	15,800	15,800	12,800	13,600	13,800	14,000	11,400	11,800	12,000	12,000
70	14,800	15,800	13,200	13,400	12,400	13,000	13,400	13,600	11,200	11,600	11,800	11,800
75	14,000	15,000	11,000	11,200	11,800	12,400	12,200	12,600	10,800	11,200	11,600	11,600
80	13,000	13,000	9,000	9,400	11,400	12,000	10,200	10,600	10,400	10,800	11,000	11,400
85	11,200	11,200	7,400	7,800	11,000	11,600	8,400	8,800	10,200	10,600	9,200	9,600
90	9,800	9,800	6,000	6,200	10,400	10,400	6,800	7,200	10,000	10,400	7,600	8,000
95	8,400	8,400	4,600	5,000	9,000	9,000	5,600	6,000	9,200	9,400	6,000	6,600
100	7,200	7,200	3,400	3,800	7,600	7,800	4,200	4,800	8,000	8,200	4,800	5,400
105	6,200	6,200	2,400	2,800	6,600	6,800	3,200	3,600		7,000	3,600	4,200
110	5,200	5,400			5,600	5,800	2,200	2,600		6,000	2,600	3,000
115	4,400	4,400			4,600	4,800				5,000		2,200
120		3,600				4,000						
125		3,000				3,200						
130		2,400				2,600						
T1 T2 T3 %												
T1	100/0	100/0	100	100	100/0	100/0	100	100	100/0	100/0	100	100
T2	25/75	50/100	75	100	25/75	50/100	75	100	25/75	50/100	75	100
T3	25/75	50/100	75	100	25/75	50/100	75	100	25/75	50/100	75	100



99 - 151 ft.
(30.0 - 46.0 m)



53 ft.
(16.0 m)



9,300 lbs.
(4200 kg)



100%



360°



85% Domestic (Pounds)

(Feet)	53' - 0° LATTICE EXT.				53' - 16° LATTICE EXT.				53' - 30° LATTICE EXT.			
	99	116	133	151	99	116	133	151	99	116	133	151
20												
25	15,400											
30	15,400	15,400	14,800									
35	15,400	15,400	14,600									
40	14,800	15,200	14,000	13,400	10,800	11,000						
45	13,400	14,000	13,600	13,000	10,200	10,400	10,400					
50	12,600	13,000	13,200	12,600	9,800	10,000	10,000	10,000	8,200	8,400		
55	11,800	12,400	12,600	12,200	9,200	9,600	9,600	9,600	7,800	8,000	8,000	
60	11,000	11,600	12,000	11,800	8,800	9,200	9,200	9,400	7,600	7,800	7,800	7,800
65	10,400	11,000	11,400	11,400	8,400	8,800	9,000	9,000	7,400	7,600	7,600	7,600
70	9,800	10,400	10,800	11,000	8,000	8,400	8,600	8,800	7,200	7,400	7,400	7,400
75	9,400	10,000	10,400	10,600	7,800	8,200	8,400	8,400	6,800	7,200	7,200	7,200
80	8,800	9,400	9,800	10,000	7,400	7,800	8,000	8,200	6,600	7,000	7,000	7,200
85	8,400	8,800	8,800	9,000	7,200	7,600	7,800	8,000	6,400	6,800	6,800	7,000
90	8,000	8,600	7,400	7,600	7,000	7,400	7,600	7,800	6,400	6,600	6,800	6,800
95	7,600	8,200	6,200	6,400	6,800	7,000	7,400	7,400	6,200	6,400	6,600	6,600
100	7,200	7,800	5,000	5,200	6,400	6,800	6,400	6,600	6,000	6,200	6,400	6,600
105	7,000	7,400	4,000	4,200	6,200	6,600	5,200	5,600	6,000	6,200	6,200	6,400
110	6,600	6,600	3,000	3,200	6,200	6,400	4,200	4,400	5,800	6,000	5,200	5,400
115	5,800	5,600	2,200	2,400	6,000	6,400	3,400	3,600	5,800	6,000	4,200	4,400
120	5,000	4,800			5,600	5,600	2,400	2,600	5,800	5,800	3,200	3,400
125	4,400	4,200			4,800	4,800		2,000		5,200	2,400	2,600
130	3,600	3,600			4,000	4,000				4,400		
135	3,000	3,000			3,400	3,400				3,600		
140		2,400				2,800						
145						2,200						
T1 T2 T3 %												
T1	100/0	100/0	100	100	100/0	100/0	100	100	100/0	100/0	100	100
T2	25/75	50/100	75	100	25/75	50/100	75	100	25/75	50/100	75	100
T3	25/75	50/100	75	100	25/75	50/100	75	100	25/75	50/100	75	100

THIS CHART IS ONLY A GUIDE AND SHOULD NOT BE USED TO OPERATE THE CRANE. The individual crane's load chart, operating instructions and other instructional plates must be read and understood prior to operating the crane.





































Rated Lifting Capacities

Important Notes:

Warning: THIS CHART IS ONLY A GUIDE.
 The notes below are for illustration only and should not be relied upon to operate the crane. The individual crane's load chart, operating instructions and other instruction plates must be read and understood prior to operating the crane.

1. All rated loads have been tested to and meet minimum requirements of SAEJ1063 NOV93 - Cantilevered Boom Crane Structures - Method of Test, and do not exceed 85% of the tipping load on outriggers as determined by SAEJ765 OCT90 Crane Stability Test Code.
2. Capacities given do not include the weight of hook blocks, slings, auxiliary lifting equipment and load handling devices. Their weights must be added to the load to be lifted. When more than minimum required reeving is used, the additional rope weight shall be considered part of the load.
3. All capacities are for crane on firm, level surface. It may be necessary to have structural supports under the outrigger floats or tires to spread the load to a larger bearing surface.
4. When either boom length or radius or both are between values listed, the smallest load shown at either the next larger radius or boom length shall be used.
5. For outrigger operation, ALL outriggers shall be properly extended with tires raised free of ground before raising the boom or lifting loads.

Symbols Glossary

 Frame	 Steering
 Outriggers	 Transmission
 Outrigger Controls	 Axles
 Engine	 Brakes
 Fuel Tank Capacity	 Tires
 Electrical System	 Suspension
 Drive	 360° Rotation
 Lights	 Boom Elevation
 Cab	 Swing
 Boom	 Counterweight
 Fixed Swingaway	 Oil
 Tele-Swingaway	 Hydraulic System
 Jib	 Hoist
 Boom Nose	 Radius
 Boom Extension	 Boom Length
 Speed	 Hookblock
 Grade	 Gear
 Lattice Extension	 Luffing Jib

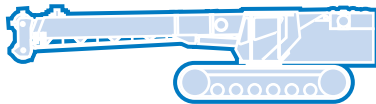
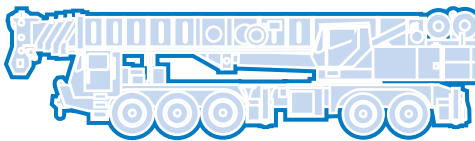
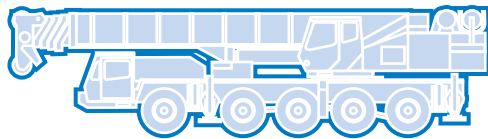
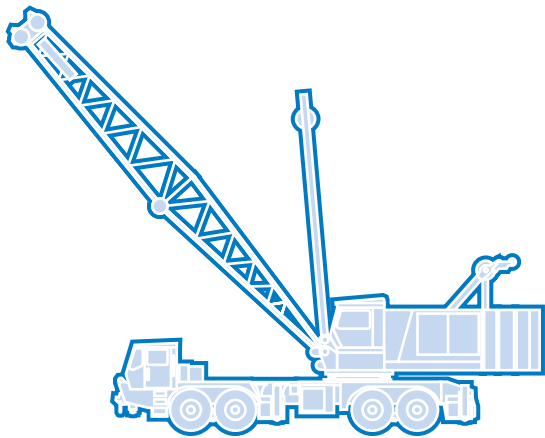

Grove Worldwide – World Headquarters

Grove North America
 1565 Buchanan Trail East
 P.O. Box 21
 Shady Grove, Pennsylvania 17256, U.S.A
 Tel: [Int + 1] (717) 597-8121
 Fax: [Int + 1] (717) 597-4062
 Western Hemisphere, Asia/Pacific

Grove Europe Limited*

Sunderland SR4 6TT, England
 Tel: [Int + 44] 191 565-6281
 Fax: [Int + 44] 191 564-0442
 Europe, Africa, Middle East

Grove Europe Limited*

P.O. Box No. 268
 4A Kimber Road
 Abingdon, Oxfordshire, OX141SG
 Tel: [Int + 44] 1235 55-3184
 Fax: [Int + 44] 1235 55-3218

Deutsche Grove GmbH

Sales and Service
 Helmholtzstrasse 12, Postfach 5026
 D-40750 Langenfeld, Germany
 Tel: [Int + 49] (2173) 8909-0
 Fax: [Int + 49] (2173) 8909-30

Wilhelmshaven Works

Industriegelände West, Postfach 1853
 D-26358 Wilhelmshaven, Germany
 Tel: [Int + 49] (4421) 294-0
 Fax: [Int + 49] (4421) 294-301

Grove France S.A.

16, chaussée Jules-César, 95520 OSNY
 B.P. 203, 95523 CERGY PONTOISE CEDEX
 France
 Tel: [Int + 33] (1) 30313150
 Int: [Int + 33] (1) 30386085

*Grove Europe Limited, Registered in England,
 Number 1845128, Registered office, Crown Works,
 Pallion, Sunderland, Tyne & Wear, England SR4 6TT

Grove Asia/Pacific - Regional Office

171 Chin Swee Road
 #06-01 San Centre
 Singapore 0316
 Tel: [Int + 65] 536-6112
 Fax: [Int + 65] 536-6119
 Asia/Pacific, Near East

Grove China - Representative Office

Beijing Hotel Room 6074
 No. 33 East Chang An Avenue
 Beijing, 100004, China
 Tel: [Int + 86] (10) 513-7766
 Fax: [Int + 86] (10) 513-7307

Grove Product Support

Western Hemisphere, Asia/Pacific
 1086 Wayne Avenue
 Chambersburg, Pennsylvania USA
 Tel: [Int + 1] (717) 263-5100
 Fax: [Int + 1] (717) 267-0404

Europe, Africa, Middle East
 Sunderland SR4 6TT, England
 Tel: [Int + 44] 191 565-6281
 Parts Fax: [Int + 44] 191 510-9242
 Service Fax: [Int + 44] 191 510-9560

Constant improvement and engineering progress make it necessary that we reserve the right to make specification, equipment, and price changes without notice. Illustrations shown may include optional equipment and accessories and may not include all standard equipment.

Distributed By: