

# GMK5150L

## Product Guide

ASME B30.5 • Imperial 85%



### Features

- 150 t (175 USt) capacity
- 60 m (197 ft) six-section boom
- 11,2 m (36 ft) / 17,8 m (58 ft) bi-fold swingaway
- 8 m (26 ft) boom and 8 m (26 ft) jib extensions for a maximum total length of 33,8 m (111 ft)
- Single engine design - less fuel consumption

# GROVE GMK5150L

Any lift. Anywhere. The GMK5150L provides maximum versatility, roadability and strong capacities to give you one of the best five-axle cranes available on the market.

## Features

### > Superior strength and reach

Get impressive strength and reach including 11,8 t (13 USt) lifting capacity with 60 m (197 ft) boom. The boom can be further extended with an 17,8 m (58 ft) swingaway and one 8 m (26 ft) boom extension and / or one 8 m (26 ft) jib insert to a maximum length of 33,8 m (111 ft) with up to 50° offset.

### > Convenient transportation logistics

Multiple counterweight configurations provides greater roadability and additional transport savings.

### > Innovative single-engine concept

The new single-engine concept on the GMK5150L with the latest EUROMOT 4/Tier 4 final engine reduces fuel consumption to a minimum. Using the ECO mode, the GMK5150L is the most fuel efficient crane in its class.



## > CraneSTAR®

### CraneSTAR is an exclusive and innovative crane asset management system

that helps improve your profitability and reduce costs by remotely monitoring critical crane data. Visit [www.cranestar.com](http://www.cranestar.com) for more information.

## Jobsite benefits

- 150 t (175 USt) Capacity - With 15% better charts than its predecessor. The GMK5150L provides the strongest taxi and maxi charts in its class. This enables you to get more done.
- Compact length and a minimum width of 2,75 m (9 ft) allow access to even narrow jobsites, while optimizing crane set up and lifting position.
- MEGATRAK™ independent suspension, all-wheel steering system and steer by wire technology provides increased ground clearance, adjustable suspension and reduces tire-wear to provide maximum maneuverability in all-terrains.

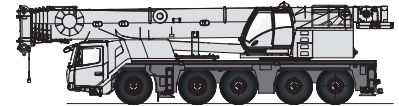

**Manitowoc Crane Care when you need it.**

The assurance of the world's most advanced crane service and support to get you back to work fast.



**Manitowoc Finance helps you get right to work generating profits for your business.**

Financial tools that help you capitalize on opportunity with solutions that fit your needs.

# Contents

**Dimensions** \_\_\_\_\_ 5

**Data** \_\_\_\_\_ 11

**Weights** \_\_\_\_\_ 12

**Working range (Main boom)** \_\_\_\_\_ 14

**Load chart (Main boom)** \_\_\_\_\_ 15

**Working range (Main boom and bi-fold swingaway)** \_\_\_\_\_ 27

**Load chart (Main boom and bi-fold swingaway)** \_\_\_\_\_ 28

**Specifications** \_\_\_\_\_ 31

**Symbols glossary** \_\_\_\_\_ 32

# Dimensions

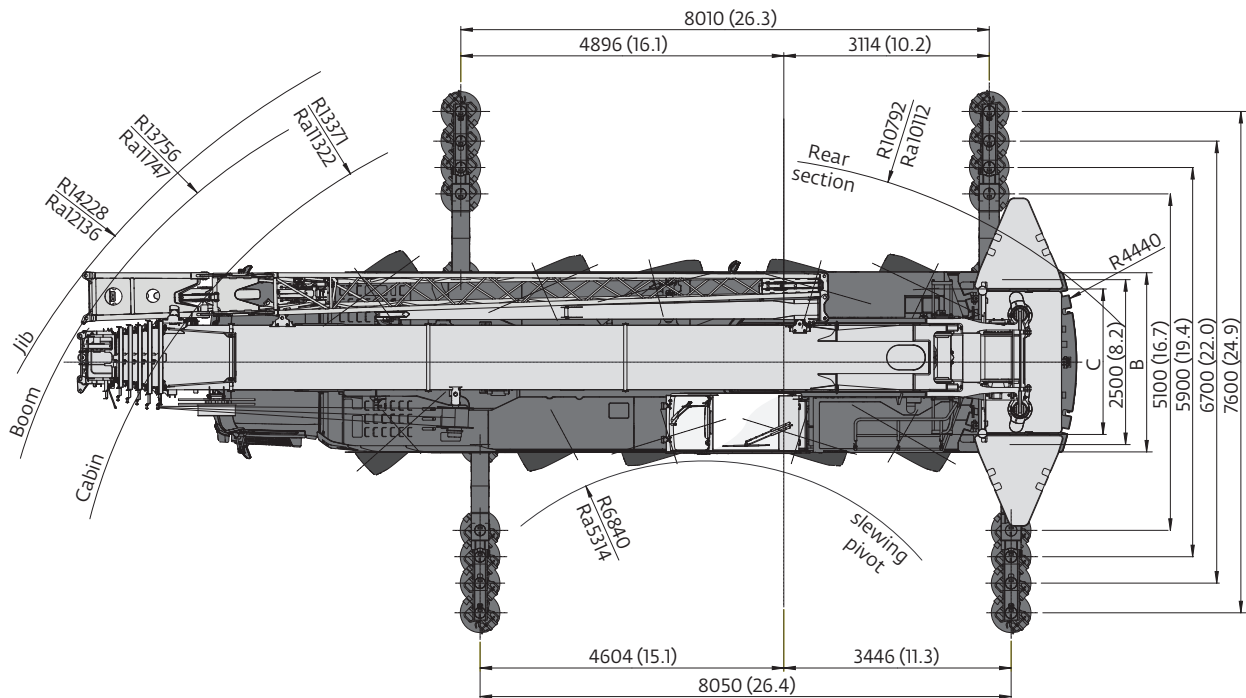
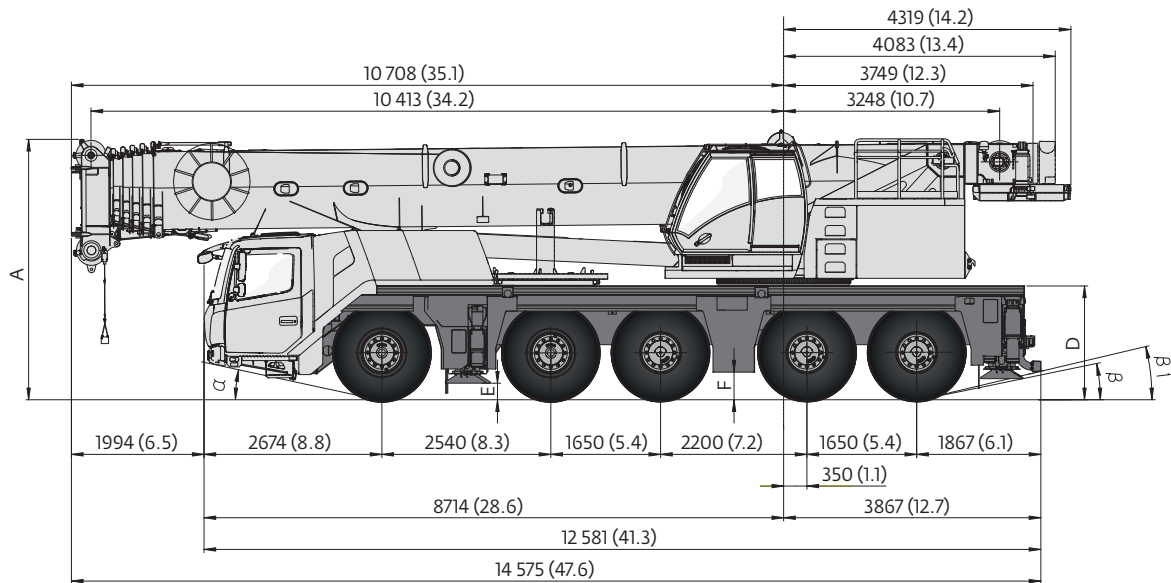

Dimensions in mm (ft) unless otherwise noted.

Ra = Radius all wheels steered

	A	A 105 mm** (0.3)	B	C	D	E	F	α	β	β <sub>1</sub>
R14,00/R25	3935 (12.9)	3805 (12.5)	2750 (9.0)	2298 (7.5)	1732 (5.7)	272 (0.9)	431 (1.4)	12°	12°	13°
R16,00/R25	3998 (13.1)	3868 (12.7)	2750 (9.0)	2276 (7.4)	1795 (5.9)	335 (1.1)	494 (1.6)	14°	15°	16°
R20,50/R25	3998 (13.1)	3868 (12.7)	2900 (9.5)	2296 (7.5)	1795 (5.9)	335 (1.1)	494 (1.6)	14°	15°	16°

\*\*Lowered

# Dimensions

## Standard Counterweight

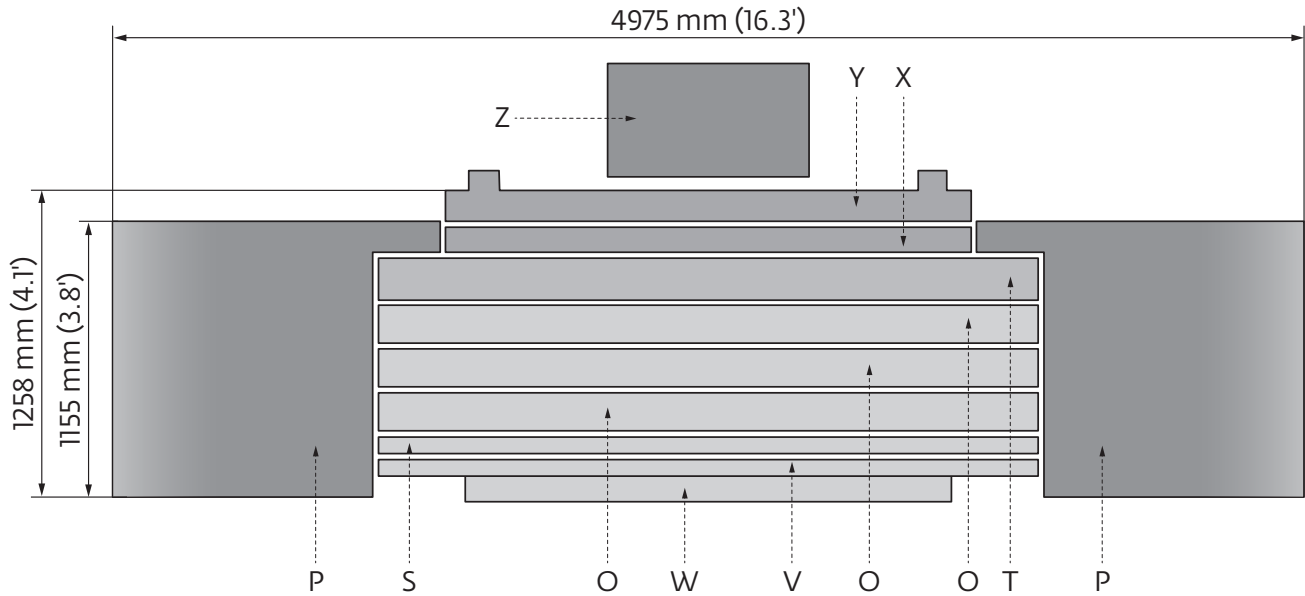

	Z 1,0 t (1.1 USt)	Y 2,3 t (2.5 USt)	X 2,3 t (2.5 USt)	W 2,3 t (2.5 USt)	V 2,3 t (2.5 USt)	U 2,3 t (2.5 USt)	T 4,6 t (5.1 USt)	O 4,6 t (5.1 USt)	P 6,8 t (7.5 USt)
1 t (1.1 USt)	x								
3,3 t (3.6 USt)	x	x							
3,3 t (3.6 USt)	x			x					
5,6 t (6.2 USt)	x	x	x						
5,6 t (6.2 USt)	x			x	x				
7,9 t (8.7 USt)	x	x	x	x					
7,9 t (8.7 USt)	x			x	x	x			
10,2 t (11.2 USt)	x	x	x	x	x				
10,2 t (11.2 USt)	x			x	x			x	
12,5 t (13.8 USt)	x	x	x	x	x	x			
12,5 t (13.8 USt)	x			x	x	x		x	
14,8 t (16.3 USt)	x	x	x	x	x			x	
14,8 t (16.3 USt)	x			x	x			2x	
17,1 t (18.8 USt)	x	x	x	x				2x	
17,1 t (18.8 USt)	x			x	x	x		2x	
19,4 t (21.4 USt)	x	x	x	x	x			2x	
19,4 t (21.4 USt)	x			x	x			3x	
21,7 t (23.9 USt)	x	x	x	x				3x	
21,7 t (23.9 USt)	x			x	x	x		3x	
24,0 t (25.5 USt)	x	x	x	x	x			3x	
24,0 t (25.5 USt)	x			x	x		x	3x	
26,3 t (29.0 USt)	x	x	x	x	x	x		3x	
26,3 t (29.0 USt)	x			x	x	x	x	3x	
30,9 t (31.1 USt)	x	x	x	x	x	x	x	3x	
44,5 t (49.0 USt)	x	x	x	x	x	x	x	x	2x

# Dimensions

## Flexible split counterweight

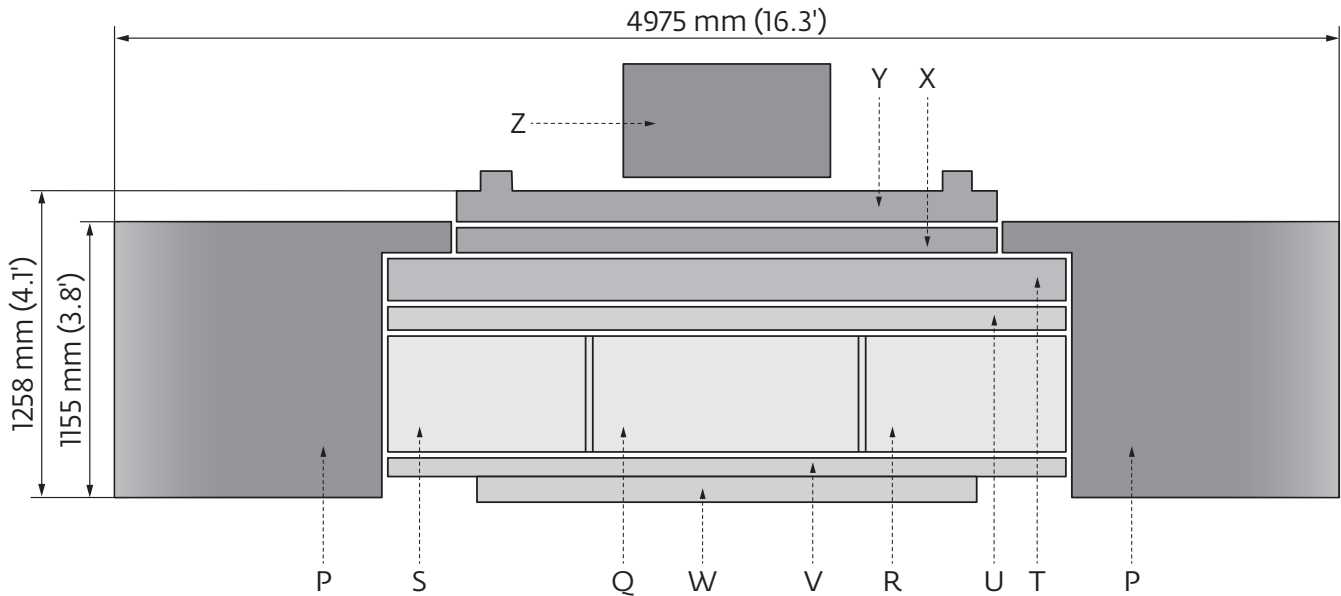

	Z 1,0 t (1.1 USt)	Y 2,3 t (2.5 USt)	X 2,3 t (2.5 USt)	W 2,3 t (2.5 USt)	V 2,3 t (2.5 USt)	U 2,3 t (2.5 USt)	T 4,6 t (5.1 USt)	S 4,6 t (5.1 USt)	R 4,6 t (5.1 USt)	Q 4,6 t (5.1 USt)	P 6,8 t (7.5 USt)
1 t (1.1 USt)	x										
3,3 t (3.6 USt)	x	x									
3,3 t (3.6 USt)	x			x							
5,6 t (6.2 USt)	x	x	x								
5,6 t (6.2 USt)	x			x		x					
7,9 t (8.7 USt)	x	x	x	x							
7,9 t (8.7 USt)	x			x	x	x					
10,2 t (11.2 USt)	x	x	x	x	x						
10,2 t (11.2 USt)	x			x		x	x				
12,5 t (13.8 USt)	x	x	x	x	x	x					
12,5 t (13.8 USt)	x			x	x	x	x				
14,8 t (16.3 USt)	x	x	x	x	x		x				
14,8 t (16.3 USt)	x			x	x			x	x		
17,1 t (18.8 USt)	x	x	x	x	x	x	x				
17,1 t (18.8 USt)	x			x	x	x		x	x		
19,4 t (21.4 USt)	x	x	x	x	x			x	x		
19,4 t (21.4 USt)	x			x	x		x	x	x		
21,7 t (23.9 USt)	x	x	x	x	x	x		x	x		
21,7 t (23.9 USt)	x			x	x	x	x	x	x		
24,0 t (25.5 USt)	x	x	x	x	x		x	x	x		
24,0 t (25.5 USt)	x			x	x		x	x	x	x	
26,3 t (29.0 USt)	x	x	x	x	x	x	x	x	x		
26,3 t (29.0 USt)	x			x	x	x	x	x	x	x	
30,9 t (31.1 USt)	x	x	x	x	x	x	x	x	x	x	
44,5 t (49.0 USt)	x	x	x	x	x	x	x	x	x	x	2x

# Dimensions

## Heavy roadable counterweight

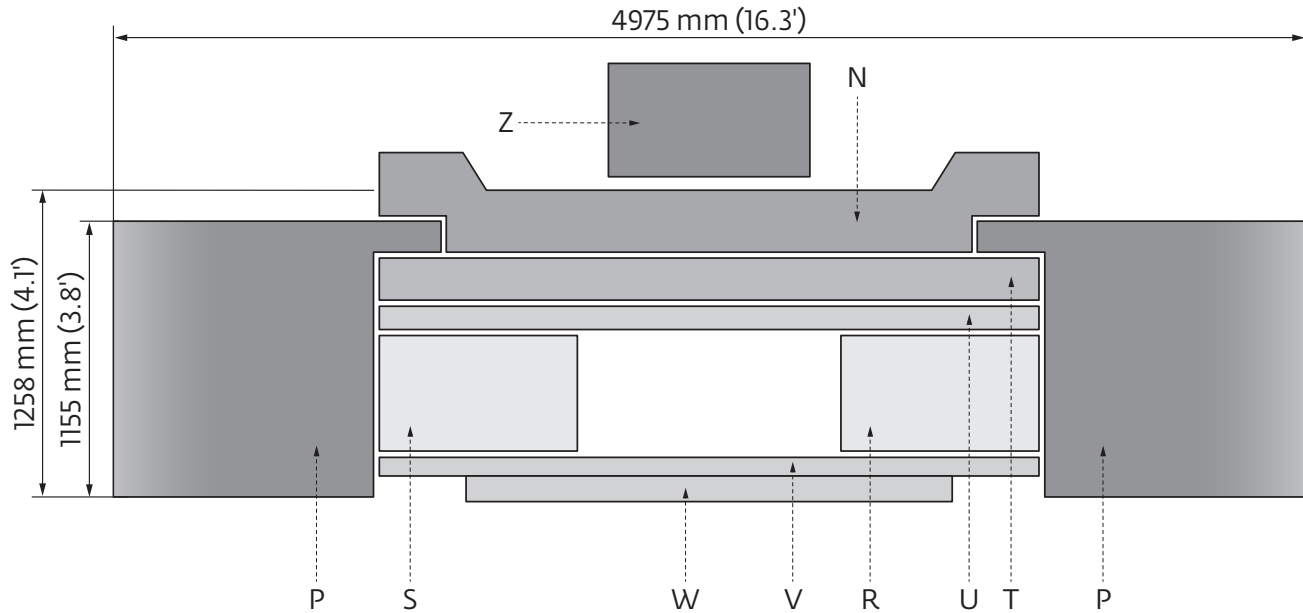

	<b>Z</b> 1,0 t (1.1 USt)	<b>W</b> 2,3 t (2.5 USt)	<b>V</b> 2,3 t (2.5 USt)	<b>U</b> 2,3 t (2.5 USt)	<b>T</b> 4,6 t (5.1 USt)	<b>S</b> 4,6 t (5.1 USt)	<b>R</b> 4,6 t (5.1 USt)	<b>N*</b> 9,2 t (10.1 USt)	<b>P</b> 6,8 t (7.5 USt)
1 t (1.1 USt)	x								
3,3 t (3.6 USt)	x								
5,6 t (6.2 USt)	x	x		x					
7,9 t (8.7 USt)	x	x	x	x					
10,2 t (11.2 USt)	x	x		x	x				
10,2 t (11.2 USt)	x							x	
12,5 t (13.8 USt)	x	x						x	
14,8 t (16.3 USt)	x	x	x			x	x		
14,8 t (16.3 USt)	x	x						x	
17,1 t (18.8 USt)	x	x	x	x		x	x		
17,1 t (18.8 USt)	x	x	x	x				x	
19,4 t (21.4 USt)	x	x	x		x	x	x		
19,4 t (21.4 USt)	x	x		x	x			x	
21,7 t (23.9 USt)	x	x	x	x	x	x	x		
21,7 t (23.9 USt)	x	x	x	x	x			x	
24,0 t (25.5 USt)	x	x	x			x	x	x	
26,3 t (29.0 USt)	x	x	x	x		x	x	x	
30,9 t (31.1 USt)	x	x	x	x	x	x	x	x	
44,5 t (49.0 USt)	x	x	x	x	x	x	x	x	2x

\* fixed to superstructure, removable with tools only



# Dimensions

## Hose reel

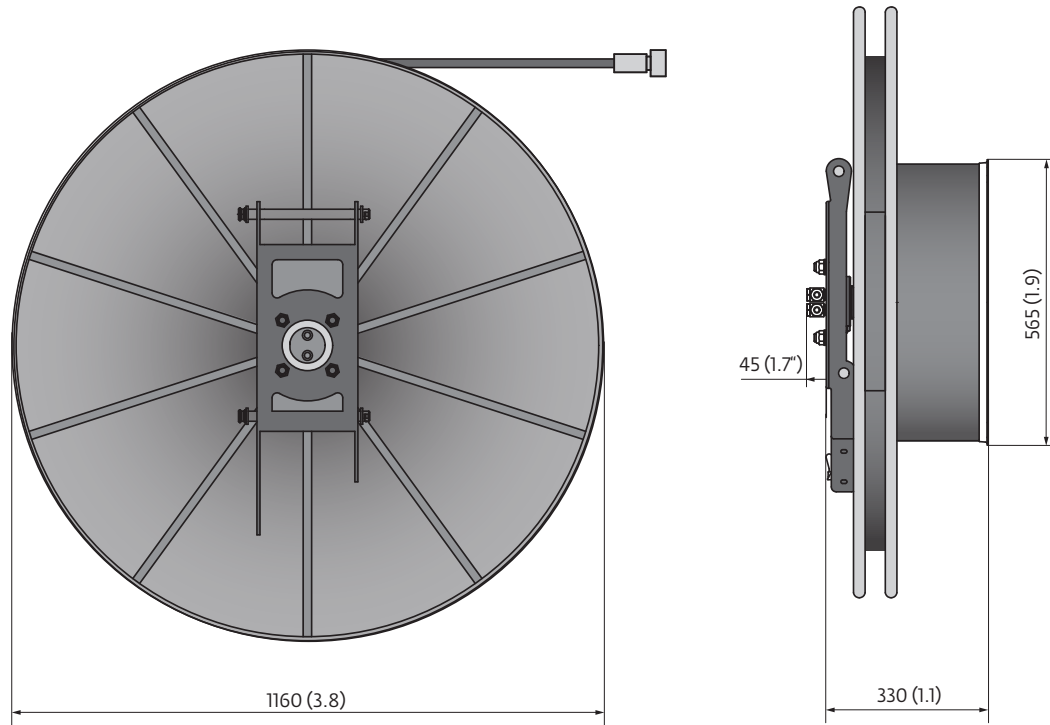

*Dimensions in mm (ft) unless otherwise noted.*

**165 kg (364 lb)**

# Dimensions

## Jib combinations

	L x W x H (m)	kg
<b>A</b>	3,8 x 0,8 x 1,3 (12.5' x 2.6' x 4.3')	950 (2094 lb)
<b>B</b>	8,5 x 0,8 x 1,1 (27.9' x 2.6' x 3.6')	575 (1268 lb)
<b>C</b>	6,9 x 0,5 x 0,7 (6.9' x 1.6' x 2.3')	350 (772 lb)
<b>D</b>	9,0 x 0,8 x 1,1 (29.5' x 2.6' x 3.6')	525 (1157 lb)
<b>E</b>	8,1 x 0,8 x 1,1 (26.6' x 2.6' x 3.6')	650 (1433 lb)

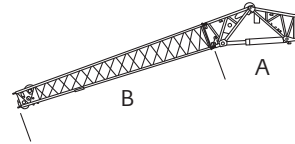

11,2 m (36 ft)

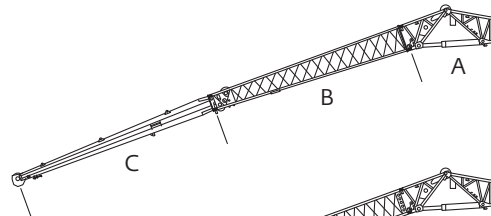

17,8 m (58 ft)

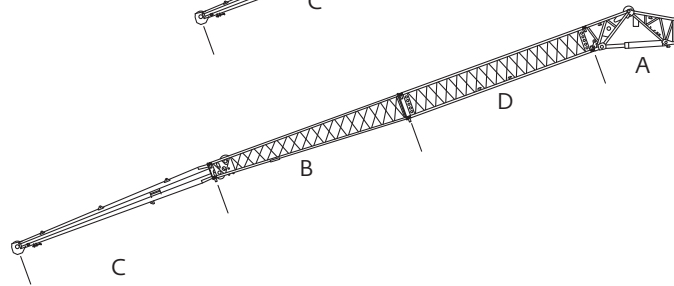

25,8 m (85 ft)

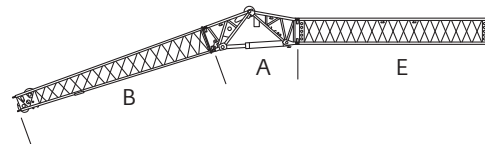

19,2 m (63 ft)

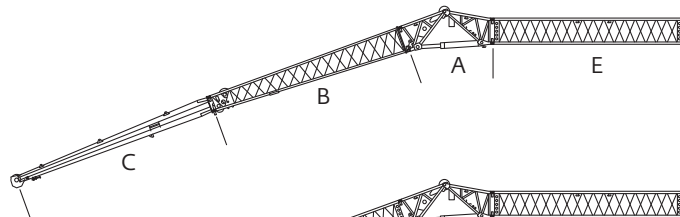

25,8 m (85 ft)

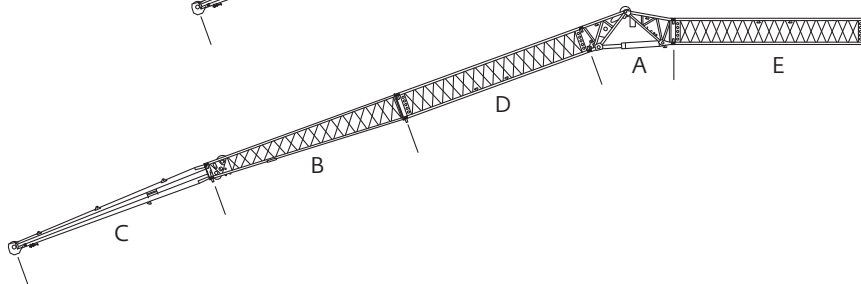

33,8 m (111 ft)



Lifting Capacity	Sheaves	Weight	Parts of line	Possible load with crane*
140 t (154 USt)	8	1600 kg (3527 lb)	2-17 •	130 t (143 USt) •
95 t (105 USt)	5	1300 kg (2866 lb)	2-11	92 t (101 USt)
60 t (66 USt)	3	950 kg (2094 lb)	2-7	58,5 t (64.5 USt)
26 t (29 USt)	1	500 kg (1102 lb)	2-3	25 t (27.5 USt)
9 t (10 USt)	H/B	200 kg (441 lb)	1	8 t (9 USt)

\* varies depending on national regulations  
 ▪ 0° over rear with additional equipment

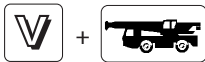

	1	2	3	4	5	6	7	8	9	10	11	12	13	14	15	16	R1	R2	
mp/h	4.0	4.7	5.8	7.0	8.8	10.5	12.4	15.5	17.4	21.1	25.5	31.1	38.5	46.6	52.8	52.8	4.0	4.8	
mp/h	1.8	2.2	2.6	3.2	4.0	4.7	5.6	6.8	8.1	9.3	11.8	14.3	17.4	21.1	25.5	30.4	1.8	2.2	70%
	14.00 R25																		



	Infinitely variable	Rope	Max. single line pull
	Single line 0-120 m/min (0-394 f/min)	19 mm (836 ft)	84,0 kN (18,884 lb)
	Single line 0-120 m/min (0-394 f/min)	19 mm (836 ft)	84,0 kN (18,884 lb)
	0 - 1,5 min <sup>-1</sup>		
	-1,5° to + 83° approx. 48 s		
	approx. 400 s 12,8 m to 60,0 m (42 ft to 197 ft)		

# Weights

## Boom over front

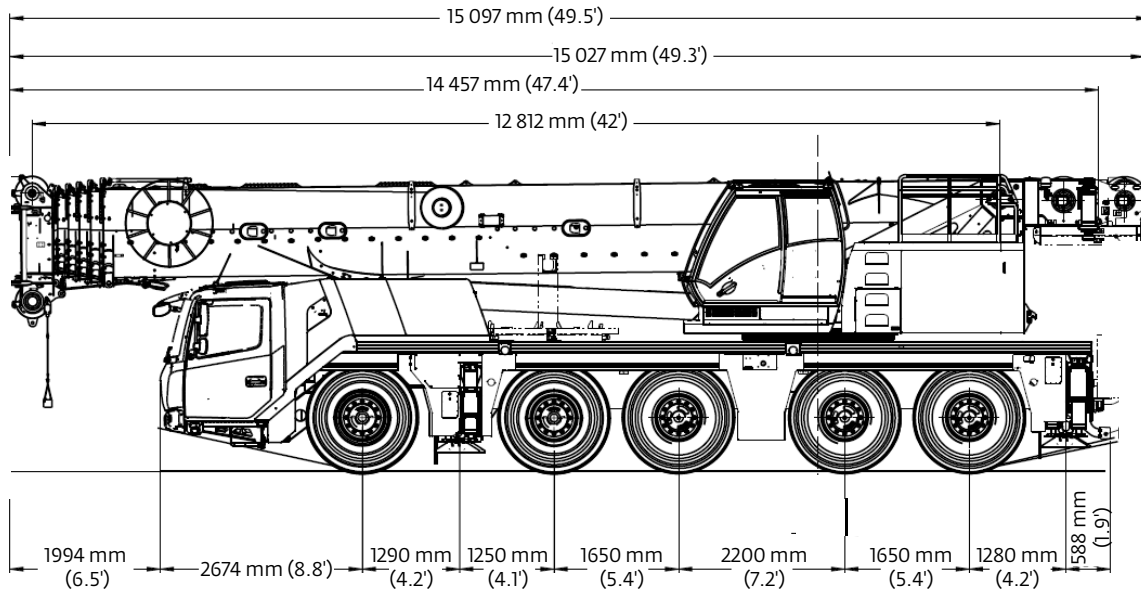

Basic Weights	Axles 1 and 2		Axles 3-5		Total	
GMK5150L Mercedes-Benz power Tier 4 Final with: 16.00R25 tires, 10x6x10 drive/steer, 2nd oil cooler, outrigger pads, auxiliary hoist, driver and tanks filled, 26 t (29 Ust) hook block on bumper	22 900 kg	50,500 lb	18 460 kg	61,020 lb	50 590 kg	111,530 lb
<b>Additions</b>						
10x8x10 drive/steer	180 kg	397 lb	220 kg	486 lb	400 kg	883 lb
Electric driveline retarder	87 kg	191 lb	0 kg	0 lb	87 kg	191 lb
Spare wheel 14.00 R25 XGC steel rim with stowage	-210 kg	-464 lb	481 kg	1061 lb	271 kg	597 lb
Spare wheel 16.00 R25 XGC steel rim with stowage	-252 kg	-555 lb	576 kg	1269 lb	324 kg	714 lb
Spare wheel 20.5 R25 XGC steel rim with stowage	-301 kg	-663 lb	688 kg	1516 lb	387 kg	853 lb
Brackets for hydraulic swingaway	105 kg	233 lb	5 kg	10 lb	110 kg	243 lb
Hose reel + parts for hydraulic swingaway	293 kg	646 lb	-128 kg	-282 lb	165 kg	364 lb
11 m-18 m (36 ft - 59 ft) hydraulic swingaway	2230 kg	4915 lb	-370 kg	-816 lb	1860 kg	4099 lb
Auxiliary boom nose	176 kg	389 lb	-94 kg	-207 lb	82 kg	182 lb
(2) 2300 kg (5070 lb) sections pinned to superstructure	-3112 kg	-6862 lb	7614 kg	16,787 lb	4502 kg	9925 lb
2300 kg (5070 lb) section pinned to superstructure	-1586 kg	-3497 lb	3880 kg	8555 lb	2294 kg	5058 lb
2300 kg (5070 lb) section stowed on carrier	1757 kg	3874 lb	557 kg	1227 lb	2314 kg	5101 lb
(2) 2300 kg (5070 lb) sections stowed on carrier	3517 kg	7755 lb	1115 kg	2457 lb	4632 kg	10,212 lb
<b>Substitutions:</b>						
14.00R25 tires	-212 kg	-468 lb	-318 kg	-700 lb	-530 kg	-1168 lb
20.5R25 tires	252 kg	555 lb	378 kg	834 lb	630 kg	1389 lb
<b>Removals:</b>						
Boom assembly	-12 184 kg	-26,860 lb	-2898 kg	-6389 lb	-15 082 kg	-33,249 lb
Front outriggers	-1697 kg	-3741 lb	- 6 kg	(-13) lb	-1703 kg	-3754 lb
Rear outriggers	1208 kg	2663 lb	-3125 kg	-6890 lb	-1917 kg	-4227 lb
Front and rear outrigger floats	-34 kg	-75 lb	-152 kg	-336 lb	-186 kg	-411 lb

## Trailing Boom

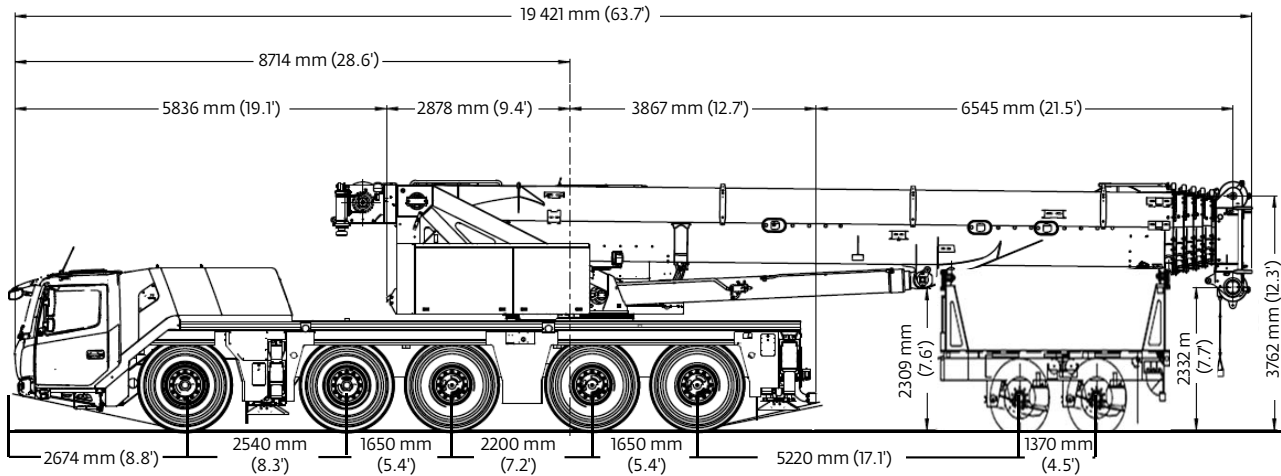

Basic Weights	Axles 1 and 2		Axles 3-5		2 Dolly Axles		Total	
GMK5150L Mercedes-Benz power Tier 4 Final with: 16.00R25 tires, 10x8x10 drive/steer, 11 m - 18 m (36 ft - 59 ft) hydraulic luffing swingaway, 2nd oil cooler, outrigger pads, auxiliary hoist, driver and tanks filled, 2 axle boom dolly (2994 kg [6600 lb])	17 800 kg	39,260 lb	23 190 kg	51,120 lb	14 620 kg	32,240 lb	55 620 kg	122,620 lb
<b>Additions:</b>								
2300 kg (5070 lb) section on superstructure or carrier front	1760 kg	3860 lb	570 kg	1230 lb			2310 kg	5100 lb
(2) 2300 kg (5070 lb) sections stowed on carrier front	3520 kg	7740 lb	1110 kg	2460 lb			4630 kg	10,210 lb
<b>Removals:</b>								
Brackets for hydraulic swingaway	-20 kg	-40 lb	-10 kg	-30 lb	-80 kg	-180 lb	-110 kg	-240 lb
Hose reel + parts for hydraulic swingaway	5 kg	20 lb	5 kg	20 lb	-180 kg	-400 lb	-170 kg	-360 lb
11 m - 18 m (36 ft - 59 ft) hydraulic swingaway	-180 kg	-420 lb	-180 kg	-360 lb	-1500 kg	-3320 lb	-1860 kg	-4100 lb
Front outriggers	-1800 kg	-3960 lb	0 kg	0 lb			-1800 kg	-3960 lb
Rear outriggers	1260 kg	2800 lb	-3270 kg	-7230 lb			-2010 kg	-4430 lb
Front and rear outrigger floats	-30 kg	-80 lb	-150 kg	-330 lb			-180 kg	-410 lb
<b>Substitutions:</b>								
10x6x10 drive/steer	-180 kg	-400 lb	-210 kg	-480 lb			-400 kg	-880 lb
14.00R25 tires	-212 kg	-468 lb	-318 kg	-700 lb			-530 kg	-1168 lb
20.50R25 tires	252 kg	555 lb	378 kg	834 lb			630 kg	1389 lb

# Working range

Main boom

## Working range

 12,8 - 60,0 m  
(42 - 197 ft)

 7,6 m (25 ft)

 360°

 44,5 t (98,100 lb)

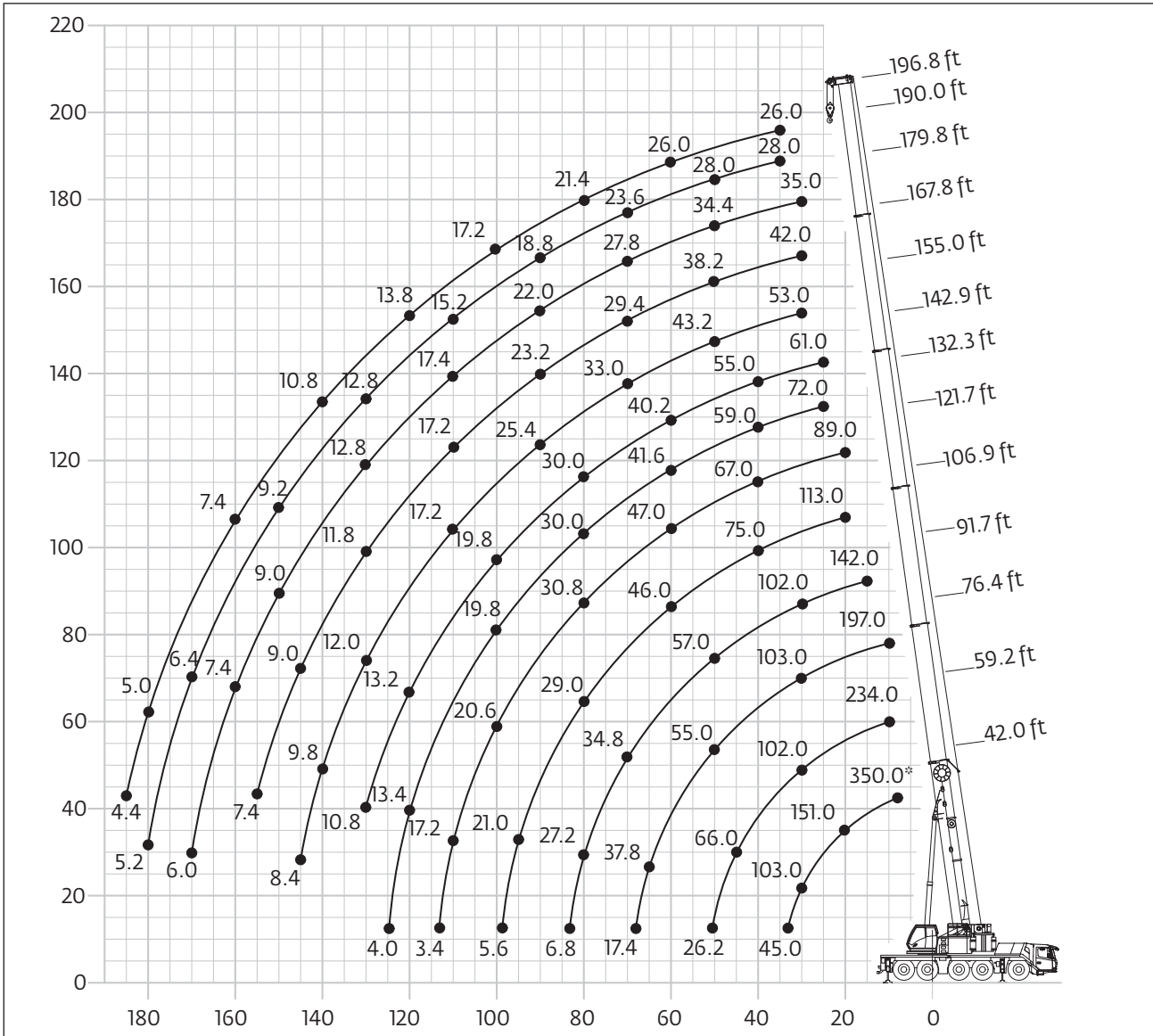

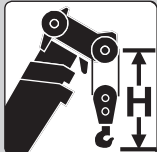
	Hook block	H
	140 D (154 USt)	3160 (10.4 ft)
95 D (105 USt)	3070 (10.1 ft)	
60 E/D (66 USt)	3000 (9.8 ft)	
26 E (29 USt)	2770 (9.1 ft)	
9 H/B (10 USt)	2350 (7.7 ft)	

# Load chart

## Main boom

### Telescopic boom



12,8 - 60,0 m  
(42 - 197 ft)



7,6 m (25 ft)



360°



44,5 t (98,100 lb)



lb x 1000

ft	42.0	59.3	76.4	91.7	106.9	116.6	121.7	133.7	146.1	155.0	167.8	179.8	190.0	196.9	ft
8.0	*350.0														8.0
10.0	**238.0	**234.0	197.0												10.0
15.0	186.0	186.0	181.0	142.0											15.0
20.0	151.0	152.0	150.0	132.0	113.0	79.0	89.0								20.0
25.0	126.0	128.0	126.0	116.0	103.0	69.0	87.0	72.0	61.0						25.0
30.0	103.0	105.0	103.0	102.0	92.0	61.0	80.0	71.0	61.0	53.0	42.0	35.0			30.0
35.0		88.0	86.0	87.0	83.0	54.0	73.0	65.0	59.0	52.0	42.0	35.0	28.0	26.0	35.0
40.0		75.0	75.0	74.0	75.0	49.0	67.0	59.0	55.0	50.0	42.0	35.0	28.0	26.0	40.0
45.0		66.0	65.0	64.0	66.0	44.0	61.0	54.0	51.0	46.0	40.8	35.0	28.0	26.0	45.0
50.0		46.0	57.0	57.0	58.0	40.8	56.0	49.0	47.0	43.2	38.2	34.4	28.0	26.0	50.0
55.0			52.0	51.0	51.0	38.0	52.0	45.0	43.6	40.4	35.8	32.8	27.8	26.0	55.0
60.0			47.0	47.0	46.0	35.2	47.0	41.6	40.2	37.8	33.4	31.0	26.4	26.0	60.0
65.0			39.6	42.4	41.4	33.0	42.8	38.4	37.2	35.2	31.4	29.4	25.0	25.0	65.0
70.0				38.0	36.8	31.2	38.6	35.6	34.4	33.0	29.4	27.8	23.6	23.8	70.0
75.0				34.0	34.2	29.4	34.4	33.0	32.0	31.0	27.8	26.2	22.4	22.6	75.0
80.0				27.2	32.0	28.0	30.8	31.0	30.0	29.0	26.0	24.6	21.0	21.4	80.0
85.0					29.2	26.6	27.8	29.0	26.8	27.4	24.6	23.4	20.0	20.4	85.0
90.0					26.6	25.4	25.2	26.4	24.2	25.4	23.2	22.0	18.8	19.2	90.0
95.0					24.2	24.2	22.8	24.0	22.6	23.0	22.0	20.8	17.8	18.2	95.0
100.0						23.2	20.6	21.8	21.6	20.8	20.8	19.6	16.8	17.2	100.0
105.0						21.4	18.8	20.0	20.6	19.0	19.0	18.4	16.0	16.2	105.0
110.0						12.2	17.2	18.2	19.0	17.2	17.2	17.4	15.2	15.4	110.0
115.0							16.6	16.8	17.4	16.2	15.8	16.6	14.6	14.6	115.0
120.0							11.2	15.4	16.0	15.4	15.0	15.2	14.0	13.8	120.0
125.0								11.0	14.8	14.8	14.2	14.0	13.4	13.0	125.0
130.0									13.6	13.6	13.4	12.8	12.8	12.4	130.0
135.0									12.4	12.6	12.4	11.8	12.0	11.6	135.0
140.0										11.6	11.4	10.8	11.0	10.8	140.0
145.0										10.8	10.4	10.0	10.2	9.8	145.0
150.0										4.2	9.6	9.6	9.2	9.0	150.0
155.0											8.8	9.2	8.4	8.2	155.0
160.0											7.4	8.4	7.8	7.4	160.0
165.0												7.6	7.0	6.8	165.0
170.0												7.0	6.4	6.2	170.0
175.0													5.8	5.6	175.0
180.0													5.2	5.0	180.0
185.0														4.4	185.0

\* Over rear with special equipment

\*\*Lifting loads > 206,000 lb can be lifted only with additional equipment

# Load chart

## Main boom

### Telescopic boom



12,8 - 60,0 m  
(42 - 197 ft)



7,6 m (25 ft)



360°



30,9 t (68,100 lb)



lb x 1000

ft	42.0	59.3	76.4	91.7	106.9	116.6	121.7	133.7	146.1	155.0	167.8	179.8	190.0	196.9	ft
10.0	**234.0														10.0
15.0	183.0	183.0	181.0												15.0
20.0	149.0	150.0	148.0	132.0											20.0
25.0	117.0	118.0	116.0	116.0	103.0	69.0	87.0								25.0
30.0	94.0	96.0	96.0	95.0	92.0	61.0	80.0	71.0	61.0						30.0
35.0		81.0	80.0	77.0	76.0	54.0	73.0	65.0	59.0	52.0	42.0	35.0	28.0	26.0	35.0
40.0		69.0	68.0	67.0	64.0	49.0	64.0	59.0	55.0	50.0	42.0	35.0	28.0	26.0	40.0
45.0		57.0	59.0	58.0	55.0	44.0	55.0	52.0	51.0	46.0	40.8	35.0	28.0	26.0	45.0
50.0		45.0	50.0	49.0	50.0	40.8	47.0	45.0	44.0	43.2	38.2	34.4	28.0	26.0	50.0
55.0			42.4	44.0	44.0	38.0	41.6	41.6	38.8	39.2	35.8	32.8	27.8	26.0	55.0
60.0			38.6	39.2	38.4	35.2	36.8	37.2	34.2	34.6	33.4	31.0	26.4	26.0	60.0
65.0			29.2	34.4	33.6	33.0	32.0	33.0	30.8	30.8	30.0	29.4	25.0	25.0	65.0
70.0				30.4	29.6	30.8	28.0	29.4	29.0	27.6	27.0	27.4	23.6	23.8	70.0
75.0				27.0	26.2	27.4	25.0	26.0	26.8	25.0	25.4	24.6	22.4	22.6	75.0
80.0				21.4	24.4	24.6	23.6	23.2	23.8	23.4	23.2	22.2	21.0	21.4	80.0
85.0					22.8	22.0	22.4	20.6	21.4	21.4	21.0	20.2	20.0	19.6	85.0
90.0					20.8	19.8	20.4	18.4	19.2	19.4	19.0	18.4	18.4	17.8	90.0
95.0					16.8	17.8	18.6	16.4	17.8	17.6	17.0	17.2	16.8	16.2	95.0
100.0						16.2	16.8	14.8	16.6	16.4	15.4	15.8	15.2	14.8	100.0
105.0						14.8	15.2	13.2	15.4	14.8	13.8	14.2	13.6	13.4	105.0
110.0						12.2	14.0	12.0	14.0	13.4	13.0	12.8	12.2	12.0	110.0
115.0							12.6	10.6	12.8	12.2	12.2	11.6	11.0	10.8	115.0
120.0								11.2	9.6	11.6	11.2	11.4	10.4	9.6	120.0
125.0									9.0	10.6	10.6	10.4	9.4	8.6	125.0
130.0										9.6	10.0	9.4	8.4	7.6	130.0
135.0											7.4	9.0	8.4	7.0	135.0
140.0												8.4	7.6	6.8	140.0
145.0												6.0	7.0	6.0	145.0
150.0												4.2	6.2	5.4	150.0
155.0													5.6	4.8	155.0
160.0													3.8	4.2	160.0
165.0														3.6	165.0
170.0														3.0	170.0
175.0														2.0	175.0

\*\*Lifting loads > 206,000 lb can be lifted only with additional equipment



# Load chart

## Main boom

### Telescopic boom



12,8 - 60,0 m  
(42 - 197 ft)



7,6 m (25 ft)



360°



26,3 t (57,900 lb)



lb x 1000

ft	42.0	59.3	76.4	91.7	106.9	116.6	121.7	133.7	146.1	155.0	167.8	179.8	190.0	196.9	ft
10.0	**234.0	**232.0	197.0												10.0
15.0	183.0	183.0	181.0	142.0											15.0
20.0	144.0	146.0	143.0	132.0	113.0	79.0	89.0								20.0
25.0	113.0	114.0	112.0	112.0	103.0	69.0	87.0	72.0	61.0						25.0
30.0	91.0	94.0	93.0	87.0	85.0	61.0	80.0	71.0	61.0	53.0	42.0	35.0			30.0
35.0		79.0	76.0	75.0	69.0	54.0	69.0	65.0	59.0	52.0	42.0	35.0	28.0	26.0	35.0
40.0		63.0	64.0	62.0	61.0	49.0	58.0	55.0	54.0	50.0	42.0	35.0	28.0	26.0	40.0
45.0		51.0	53.0	52.0	53.0	44.0	49.0	48.0	46.0	46.0	40.8	35.0	28.0	26.0	45.0
50.0		39.4	45.0	47.0	46.0	40.8	42.6	42.8	39.6	39.8	38.2	34.4	28.0	26.0	50.0
55.0			39.8	40.2	39.4	38.0	37.0	37.4	34.8	34.8	33.8	32.8	27.8	26.0	55.0
60.0			34.4	34.8	34.0	35.2	32.4	33.0	32.6	30.6	30.8	30.2	26.4	26.0	60.0
65.0			25.4	30.4	29.6	30.8	28.2	29.2	29.4	28.2	28.0	26.8	25.0	25.0	65.0
70.0				26.8	27.4	27.2	26.6	25.8	26.2	25.8	25.0	24.0	23.6	23.4	70.0
75.0				23.6	25.0	24.2	24.8	22.6	23.4	23.2	22.4	21.8	21.4	21.0	75.0
80.0				18.4	22.4	21.4	22.2	20.0	21.4	21.6	20.2	20.2	19.4	18.8	80.0
85.0					20.0	19.2	19.8	17.8	20.0	19.4	18.2	18.4	17.4	17.0	85.0
90.0					18.0	17.6	17.8	15.8	18.0	17.4	16.6	16.6	15.8	15.2	90.0
95.0					14.2	16.6	16.0	14.0	16.2	15.6	15.6	15.0	14.2	13.8	95.0
100.0						15.4	14.6	12.4	14.6	14.0	14.4	13.4	12.8	12.4	100.0
105.0						13.4	13.6	11.2	13.2	13.0	13.0	12.0	11.4	11.0	105.0
110.0						12.2	12.4	10.6	11.8	12.2	11.6	10.8	10.2	9.8	110.0
115.0							11.2	10.0	10.8	11.0	10.4	9.6	9.0	8.6	115.0
120.0							9.6	9.6	9.6	10.0	9.4	8.6	8.0	7.6	120.0
125.0								9.0	8.8	9.0	8.4	7.6	7.0	6.6	125.0
130.0									7.8	8.2	7.6	6.8	6.0	5.8	130.0
135.0									5.8	7.4	6.8	6.0	5.2	5.0	135.0
140.0										6.6	6.0	5.2	4.6	4.2	140.0
145.0										4.4	5.4	4.4	3.8	3.6	145.0
150.0										3.8	4.8	3.8	3.2	3.0	150.0
155.0											4.2	3.2	2.6	2.4	155.0
160.0											2.4	2.8	2.0	1.8	160.0
165.0												2.2			165.0
170.0												1.8			170.0

\*\*Lifting loads > 206,000 lb can be lifted only with additional equipment

# Load chart

## Main boom

### Telescopic boom

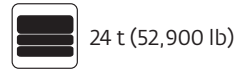
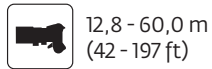

lb x 1000

ft	42.0	59.3	76.4	91.7	106.9	116.6	121.7	133.7	146.1	155.0	167.8	179.8	190.0	196.9	ft
10.0	**232.0	**232.0	197.0												10.0
15.0	182.0	182.0	181.0	142.0											15.0
20.0	142.0	143.0	141.0	132.0	113.0	79.0	89.0								20.0
25.0	111.0	112.0	110.0	106.0	102.0	69.0	87.0	72.0	61.0						25.0
30.0	90.0	92.0	90.0	85.0	81.0	61.0	79.0	71.0	61.0	53.0	42.0	35.0			30.0
35.0		74.0	75.0	71.0	68.0	54.0	65.0	62.0	59.0	52.0	42.0	35.0	28.0	26.0	35.0
40.0		59.0	61.0	59.0	59.0	49.0	55.0	52.0	51.0	50.0	42.0	35.0	28.0	26.0	40.0
45.0		49.0	50.0	52.0	50.0	44.0	46.0	47.0	43.0	43.2	40.8	35.0	28.0	26.0	45.0
50.0		36.6	43.6	44.0	43.4	40.8	39.8	40.2	37.4	37.4	36.2	34.4	28.0	26.0	50.0
55.0			37.2	37.8	37.0	38.0	34.6	35.0	34.8	32.6	32.6	32.0	27.8	26.0	55.0
60.0			32.2	32.6	31.8	33.2	30.2	30.8	30.8	30.2	29.4	28.2	26.4	26.0	60.0
65.0			23.4	28.4	29.2	28.8	28.2	27.2	27.4	27.0	26.0	25.0	25.0	24.4	65.0
70.0				25.0	26.4	25.4	26.0	24.0	24.4	25.0	23.2	23.2	22.2	21.6	70.0
75.0				22.2	23.4	22.4	23.2	21.0	22.8	22.6	20.8	20.8	19.8	19.4	75.0
80.0				16.8	20.8	20.2	20.6	18.4	20.8	20.2	19.0	18.8	17.8	17.4	80.0
85.0					18.6	19.0	18.4	16.2	18.6	18.0	17.6	16.8	16.0	15.6	85.0
90.0					16.8	17.2	16.4	14.4	16.6	16.0	16.4	15.2	14.4	14.0	90.0
95.0					13.0	15.6	15.2	12.8	14.8	14.6	14.6	13.8	13.0	12.6	95.0
100.0						14.0	13.8	12.0	13.4	13.6	13.2	12.2	11.6	11.2	100.0
105.0						13.2	12.4	11.2	12.0	12.2	11.8	10.8	10.2	10.0	105.0
110.0						12.0	11.2	10.6	10.8	11.0	10.6	9.6	9.0	8.8	110.0
115.0							10.2	10.0	9.6	10.0	9.4	8.6	8.0	7.6	115.0
120.0							8.6	9.4	8.6	9.0	8.4	7.6	7.0	6.6	120.0
125.0								8.6	7.8	8.0	7.6	6.6	6.0	5.8	125.0
130.0									7.0	7.2	6.6	5.8	5.2	4.8	130.0
135.0									4.8	6.4	6.0	5.0	4.4	4.2	135.0
140.0										5.8	5.2	4.4	3.6	3.4	140.0
145.0										3.6	4.6	3.6	3.0	2.8	145.0
150.0										3.0	4.0	3.0	2.4	2.2	150.0
155.0											3.4	2.6	1.8		155.0
160.0											1.8	2.0			160.0

\*\*Lifting loads > 206,000 lb can be lifted only with additional equipment

# Load chart

## Main boom

### Telescopic boom



12,8 - 60,0 m  
(42 - 197 ft)



7,6 m (25 ft)



360°



21,7 t (47,800 lb)



lb x 1000

ft	42.0	59.3	76.4	91.7	106.9	116.6	121.7	133.7	146.1	155.0	167.8	179.8	190.0	196.9	ft
10.0	**232.0	**230.0	197.0												10.0
15.0	182.0	182.0	181.0	142.0											15.0
20.0	140.0	141.0	139.0	132.0	113.0	79.0	89.0								20.0
25.0	109.0	111.0	110.0	101.0	98.0	69.0	87.0	72.0	61.0						25.0
30.0	87.0	91.0	85.0	83.0	77.0	61.0	75.0	71.0	61.0	53.0	42.0	35.0			30.0
35.0		70.0	72.0	68.0	67.0	54.0	62.0	59.0	57.0	52.0	42.0	35.0	28.0	26.0	35.0
40.0		55.0	57.0	58.0	56.0	49.0	52.0	51.0	48.0	48.0	42.0	35.0	28.0	26.0	40.0
45.0		46.0	49.0	49.0	47.0	44.0	43.6	43.8	40.4	40.6	39.4	35.0	28.0	26.0	45.0
50.0		34.0	41.0	41.6	40.8	40.8	37.4	37.8	37.4	35.0	34.8	34.2	28.0	26.0	50.0
55.0			35.0	35.4	34.6	35.6	32.4	32.8	32.8	32.2	31.2	29.8	27.8	26.0	55.0
60.0			30.0	30.6	31.2	31.0	30.2	28.8	28.8	29.0	27.4	26.2	26.2	25.6	60.0
65.0			21.6	26.6	28.0	27.0	27.8	25.4	26.0	26.2	24.2	24.2	23.2	22.6	65.0
70.0				23.6	24.6	23.6	24.4	22.2	24.2	23.4	21.8	21.6	20.6	20.0	70.0
75.0				21.6	21.8	21.6	21.4	19.4	21.6	21.0	20.4	19.2	18.4	17.8	75.0
80.0				15.2	19.2	20.0	19.0	17.0	19.2	18.6	18.8	17.2	16.4	16.0	80.0
85.0					17.2	17.8	17.4	14.8	17.2	16.6	17.0	15.6	14.6	14.2	85.0
90.0					15.4	16.0	15.6	13.6	15.2	15.4	15.0	14.0	13.2	12.6	90.0
95.0					12.8	14.8	14.0	12.8	13.6	14.0	13.4	12.4	11.8	11.2	95.0
100.0						13.4	12.6	12.0	12.2	12.4	12.0	11.0	10.4	10.0	100.0
105.0						12.0	11.4	11.2	10.8	11.2	10.6	9.8	9.2	8.8	105.0
110.0						11.0	10.2	10.6	9.8	10.0	9.4	8.6	8.0	7.6	110.0
115.0							9.2	9.4	8.6	9.0	8.4	7.6	7.0	6.6	115.0
120.0							7.8	8.6	7.8	8.0	7.4	6.6	6.0	5.6	120.0
125.0								7.6	6.8	7.2	6.6	5.8	5.0	4.8	125.0
130.0									6.0	6.4	5.8	5.0	4.2	4.0	130.0
135.0									4.0	5.6	5.0	4.2	3.6	3.2	135.0
140.0										5.0	4.4	3.6	2.8	2.6	140.0
145.0											2.8	3.8	2.8	2.0	145.0
150.0												2.4	2.4		150.0
155.0													2.6	1.8	155.0

\*\*Lifting loads > 206,000 lb can be lifted only with additional equipment

# Load chart

## Main boom

### Telescopic boom



12,8 - 60,0 m  
(42 - 197 ft)



7,6 m (25 ft)



360°



19,4 t (42,700 lb)



lb x 1000

ft	42.0	59.3	76.4	91.7	106.9	116.6	121.7	133.7	146.1	155.0	167.8	179.8	190.0	196.9	ft
10.0	**232.0	**230.0	197.0												10.0
15.0	181.0	181.0	181.0	142.0											15.0
20.0	137.0	139.0	137.0	130.0	113.0	79.0	89.0								20.0
25.0	107.0	109.0	105.0	96.0	93.0	69.0	87.0	72.0	61.0						25.0
30.0	81.0	86.0	84.0	79.0	76.0	61.0	71.0	68.0	61.0	53.0	42.0	35.0			30.0
35.0		66.0	67.0	65.0	63.0	54.0	58.0	56.0	54.0	52.0	42.0	35.0	28.0	26.0	35.0
40.0		53.0	54.0	56.0	52.0	49.0	48.0	48.0	44.0	45.0	42.0	35.0	28.0	26.0	40.0
45.0		43.4	46.0	46.0	44.0	44.0	40.8	41.0	40.2	37.8	36.8	35.0	28.0	26.0	45.0
50.0		31.2	38.4	38.8	38.0	38.2	34.8	35.2	35.0	34.2	33.2	31.8	28.0	26.0	50.0
55.0			32.6	33.0	33.4	33.2	32.4	30.6	30.6	31.2	29.0	27.8	27.6	26.0	55.0
60.0			27.8	28.4	29.8	28.8	29.2	26.6	28.0	27.4	25.4	25.2	24.2	23.6	60.0
65.0			19.6	25.2	26.0	25.0	25.8	23.4	25.4	24.4	23.2	22.4	21.4	20.8	65.0
70.0				22.6	22.8	23.0	22.6	20.4	22.6	21.6	21.4	19.8	18.8	18.4	70.0
75.0				20.2	20.0	20.6	20.2	17.8	20.0	19.4	19.2	17.6	16.8	16.2	75.0
80.0				13.8	17.8	18.4	18.0	15.6	17.6	17.4	17.2	15.8	15.0	14.4	80.0
85.0					16.0	16.4	16.0	14.4	15.6	16.0	15.4	14.0	13.2	12.8	85.0
90.0					14.0	15.0	14.4	13.6	13.8	14.2	13.6	12.6	11.8	11.4	90.0
95.0					12.8	13.4	12.8	12.8	12.4	12.6	12.2	11.2	10.4	10.0	95.0
100.0						12.2	11.4	11.8	11.0	11.2	10.8	9.8	9.2	8.8	100.0
105.0						10.8	10.2	10.6	9.8	10.0	9.6	8.6	8.0	7.6	105.0
110.0						9.8	9.2	9.4	8.6	9.0	8.4	7.6	6.8	6.6	110.0
115.0							8.2	8.4	7.6	8.0	7.4	6.4	5.8	5.6	115.0
120.0							6.8	7.6	6.8	7.0	6.4	5.6	5.0	4.6	120.0
125.0								6.8	6.0	6.2	5.6	4.8	4.2	3.8	125.0
130.0									5.2	5.4	4.8	4.0	3.4	3.2	130.0
135.0									3.2	4.8	4.2	3.4	2.6	2.4	135.0
140.0										4.2	3.6	2.6	2.0	1.8	140.0
145.0											2.0	2.0			145.0
150.0												2.4			150.0
155.0												2.0			155.0

\*\*Lifting loads > 206,000 lb can be lifted only with additional equipment

# Load chart

## Main boom

### Telescopic boom



12,8 - 60,0 m  
(42 - 197 ft)



7,6 m (25 ft)



360°



17,1 t (37,600 lb)



lb x 1000

ft	42.0	59.3	76.4	91.7	106.9	116.6	121.7	133.7	146.1	155.0	167.8	179.8	190.0	196.9	ft
10.0	**230.0	**230.0	197.0												10.0
15.0	181.0	181.0	180.0	142.0											15.0
20.0	135.0	137.0	132.0	124.0	113.0	79.0	89.0								20.0
25.0	106.0	108.0	100.0	96.0	88.0	69.0	86.0	72.0	61.0						25.0
30.0	76.0	81.0	80.0	75.0	74.0	61.0	68.0	64.0	61.0	53.0	42.0	35.0			30.0
35.0		62.0	63.0	64.0	60.0	54.0	55.0	54.0	50.0	50.0	42.0	35.0	28.0	26.0	35.0
40.0		50.0	52.0	53.0	49.0	48.0	45.0	45.0	43.4	41.6	40.2	35.0	28.0	26.0	40.0
45.0		40.4	43.0	43.4	41.6	41.6	38.0	38.2	38.0	37.0	35.8	34.4	28.0	26.0	45.0
50.0		28.6	35.8	36.4	36.2	35.8	34.8	32.8	32.6	33.2	30.8	29.6	28.0	26.0	50.0
55.0			30.2	30.8	32.2	31.0	31.0	28.4	30.2	29.0	27.0	26.6	25.6	24.8	55.0
60.0			25.8	27.0	27.8	26.8	27.2	24.6	26.6	25.4	25.0	23.4	22.4	21.8	60.0
65.0			17.6	24.0	24.0	24.6	23.8	21.6	23.6	22.6	22.4	20.6	19.6	19.0	65.0
70.0				21.4	21.0	21.8	21.4	18.6	21.0	20.4	19.8	18.2	17.4	16.8	70.0
75.0				18.8	18.6	19.2	18.8	16.6	18.4	18.6	17.6	16.2	15.2	14.8	75.0
80.0				12.2	16.6	17.4	16.6	15.6	16.2	16.6	15.8	14.4	13.6	13.0	80.0
85.0					14.8	15.4	14.8	14.4	14.2	14.6	14.0	12.8	12.0	11.4	85.0
90.0					13.4	13.8	13.0	13.4	12.6	13.0	12.4	11.4	10.6	10.0	90.0
95.0					12.0	12.2	11.6	12.0	11.2	11.4	11.0	10.0	9.2	8.8	95.0
100.0						11.0	10.2	10.6	9.8	10.2	9.6	8.8	8.0	7.8	100.0
105.0						9.8	9.2	9.4	8.6	9.0	8.4	7.6	6.8	6.6	105.0
110.0						8.8	8.0	8.4	7.6	8.0	7.4	6.4	5.8	5.6	110.0
115.0							7.2	7.4	6.6	7.0	6.4	5.6	4.8	4.6	115.0
120.0							5.8	6.6	5.8	6.2	5.6	4.6	4.0	3.8	120.0
125.0								5.8	5.0	5.4	4.8	3.8	3.2	3.0	125.0
130.0									4.4	4.6	4.0	3.2	2.6	2.2	130.0
135.0										4.0	3.4	2.4	1.8		135.0
140.0										3.4	2.8	1.8			140.0
145.0											2.2				145.0

\*\*Lifting loads > 206,000 lb can be lifted only with additional equipment

# Load chart

## Main boom

### Telescopic boom

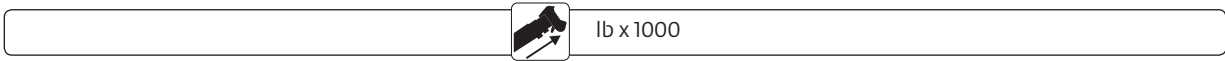
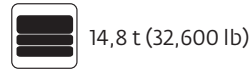
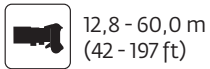

ft	42.0	59.3	76.4	91.7	106.9	116.6	121.7	133.7	146.1	155.0	167.8	179.8	190.0	196.9	ft
10.0	**230.0	**228.0	197.0												10.0
15.0	181.0	180.0	180.0	142.0											15.0
20.0	133.0	134.0	127.0	117.0	111.0	79.0	89.0								20.0
25.0	102.0	105.0	96.0	91.0	86.0	69.0	81.0	72.0	61.0						25.0
30.0	71.0	75.0	76.0	72.0	69.0	61.0	63.0	60.0	57.0	53.0	42.0	35.0			30.0
35.0		58.0	60.0	60.0	56.0	53.0	51.0	51.0	47.0	46.0	42.0	35.0	28.0	26.0	35.0
40.0		46.0	49.0	49.0	46.0	46.0	41.8	42.0	41.4	40.2	39.0	35.0	28.0	26.0	40.0
45.0		37.2	39.8	40.4	39.6	38.6	37.6	35.4	35.6	35.8	33.2	31.6	28.0	26.0	45.0
50.0		26.0	33.0	33.6	35.0	33.0	32.8	30.2	32.2	30.8	29.0	28.2	27.0	26.0	50.0
55.0			27.8	29.2	29.8	28.6	28.6	26.0	28.0	26.8	26.4	24.4	23.4	22.8	55.0
60.0			23.8	25.8	25.6	26.2	25.2	22.6	24.6	23.6	23.2	21.4	20.4	19.8	60.0
65.0			15.6	22.4	22.0	22.8	22.6	19.8	21.6	21.6	20.4	18.8	17.8	17.2	65.0
70.0				19.4	19.6	20.2	19.6	18.0	19.2	19.2	18.0	16.6	15.6	15.0	70.0
75.0				17.0	17.2	18.0	17.2	16.6	16.8	17.0	16.0	14.6	13.6	13.2	75.0
80.0				10.6	15.2	15.8	15.0	15.4	14.6	15.0	14.2	12.8	12.0	11.6	80.0
85.0					13.6	14.0	13.2	13.6	12.8	13.2	12.6	11.4	10.6	10.0	85.0
90.0					12.0	12.4	11.6	12.0	11.2	11.6	11.0	10.0	9.2	8.8	90.0
95.0					10.6	11.0	10.2	10.6	9.8	10.2	9.6	8.8	8.0	7.6	95.0
100.0						9.8	9.0	9.4	8.6	9.0	8.4	7.4	6.8	6.6	100.0
105.0						8.6	8.0	8.2	7.4	7.8	7.2	6.4	5.8	5.4	105.0
110.0						7.6	7.0	7.4	6.6	6.8	6.2	5.4	4.8	4.4	110.0
115.0							6.2	6.4	5.6	6.0	5.4	4.4	3.8	3.6	115.0
120.0							4.8	5.6	4.8	5.2	4.6	3.6	3.0	2.8	120.0
125.0								4.8	4.0	4.4	3.8	3.0	2.2	2.0	125.0
130.0									3.4	3.6	3.2	2.2			130.0
135.0										3.0	2.4				135.0
140.0										2.6	2.0				140.0

\*\*Lifting loads > 206,000 lb can be lifted only with additional equipment

# Load chart

## Main boom

### Telescopic boom



12,8 - 60,0 m  
(42 - 197 ft)



7,6 m (25 ft)



360°



12,5 t (27,500 lb)



lb x 1000

ft	42.0	59.3	76.4	91.7	106.9	116.6	121.7	133.7	146.1	155.0	167.8	179.8	190.0	196.9	ft
10.0	**230.0	**228.0	197.0												10.0
15.0	180.0	180.0	179.0	142.0											15.0
20.0	131.0	132.0	123.0	111.0	105.0	79.0	89.0								20.0
25.0	95.0	99.0	93.0	86.0	83.0	69.0	76.0	72.0	61.0						25.0
30.0	65.0	70.0	71.0	70.0	64.0	61.0	59.0	58.0	53.0	53.0	42.0	35.0			30.0
35.0		54.0	57.0	56.0	52.0	51.0	47.0	47.0	46.0	43.0	41.4	35.0	28.0	26.0	35.0
40.0		42.6	45.0	46.0	43.2	42.4	41.0	38.8	39.0	39.0	36.0	34.4	28.0	26.0	40.0
45.0		34.2	36.8	37.4	38.6	35.8	35.4	32.6	34.6	33.0	31.2	30.0	28.0	26.0	45.0
50.0		23.4	30.4	31.6	32.4	30.8	30.4	27.8	29.8	28.4	28.0	25.8	24.8	24.0	50.0
55.0			25.6	27.8	27.4	28.2	27.2	23.8	25.8	25.6	24.2	22.4	21.4	20.6	55.0
60.0			22.0	23.8	23.4	24.2	23.8	21.4	22.6	22.4	21.2	19.4	18.4	17.8	60.0
65.0			13.8	20.4	20.6	21.4	20.6	19.8	19.8	19.6	18.6	17.0	16.0	15.6	65.0
70.0				17.8	17.8	18.6	17.8	18.0	17.4	17.4	16.4	14.8	14.0	13.4	70.0
75.0				15.4	16.0	16.4	15.6	16.0	15.2	15.4	14.4	13.0	12.2	11.6	75.0
80.0				9.2	14.0	14.4	13.6	14.0	13.2	13.4	12.8	11.4	10.6	10.0	80.0
85.0					12.2	12.6	11.8	12.2	11.4	11.8	11.2	10.0	9.2	8.8	85.0
90.0					10.8	11.0	10.4	10.8	10.0	10.2	9.8	8.8	8.0	7.4	90.0
95.0					9.4	9.8	9.0	9.4	8.6	9.0	8.4	7.4	6.8	6.4	95.0
100.0						8.6	7.8	8.2	7.4	7.8	7.2	6.4	5.6	5.4	100.0
105.0						7.6	6.8	7.2	6.4	6.6	6.2	5.2	4.6	4.4	105.0
110.0						6.6	6.0	6.2	5.4	5.8	5.2	4.4	3.6	3.4	110.0
115.0							5.2	5.4	4.6	5.0	4.4	3.4	2.8	2.6	115.0
120.0							3.8	4.6	3.8	4.2	3.6	2.8	2.0	1.8	120.0
125.0								4.0	3.2	3.4	2.8	2.0			125.0
130.0									2.6	2.8	2.2				130.0
135.0										2.2					135.0
140.0										1.8					140.0

\*\*Lifting loads > 206,000 lb can be lifted only with additional equipment

# Load chart

## Main boom

### Telescopic boom



12,8 - 60,0 m  
(42 - 197 ft)



7,6 m (25 ft)



360°



10,2 t (22,400 lb)



lb x 1000

ft	42.0	59.3	76.4	91.7	106.9	116.6	121.7	133.7	146.1	155.0	167.8	179.8	190.0	196.9	ft
10.0	**230.0	**228.0	197.0												10.0
15.0	177.0	177.0	176.0	142.0											15.0
20.0	128.0	128.0	115.0	109.0	98.0	79.0	89.0								20.0
25.0	87.0	93.0	87.0	83.0	78.0	69.0	70.0	66.0	61.0						25.0
30.0	60.0	65.0	67.0	65.0	60.0	58.0	54.0	54.0	51.0	49.0	42.0	35.0			30.0
35.0		50.0	53.0	52.0	48.0	47.0	45.0	43.2	42.6	42.6	39.2	35.0	28.0	26.0	35.0
40.0		39.0	41.6	42.2	42.2	39.0	38.6	35.6	37.4	35.8	33.6	31.4	28.0	26.0	40.0
45.0		31.2	33.6	34.6	35.4	33.4	32.8	29.8	31.8	30.4	29.8	27.4	26.2	25.6	45.0
50.0		20.6	27.6	30.0	29.6	30.0	28.8	25.6	27.2	26.8	25.4	23.4	22.4	21.6	50.0
55.0			23.4	25.2	25.2	25.8	25.0	23.4	23.4	23.2	22.0	20.2	19.2	18.6	55.0
60.0			19.8	21.6	21.6	22.6	21.6	21.4	20.4	20.2	19.2	17.4	16.4	16.0	60.0
65.0			11.8	18.4	19.0	19.4	18.6	19.0	17.8	17.8	16.8	15.2	14.2	13.6	65.0
70.0				15.8	16.4	16.8	16.0	16.4	15.6	15.6	14.6	13.2	12.2	11.8	70.0
75.0				13.8	14.2	14.6	13.8	14.2	13.4	13.8	12.8	11.4	10.6	10.0	75.0
80.0				7.6	12.4	12.8	12.0	12.4	11.6	12.0	11.2	9.8	9.0	8.6	80.0
85.0					10.8	11.2	10.4	10.8	10.0	10.2	9.8	8.6	7.8	7.2	85.0
90.0					9.4	9.8	9.0	9.4	8.6	8.8	8.4	7.4	6.6	6.2	90.0
95.0					8.2	8.4	7.8	8.2	7.4	7.6	7.2	6.2	5.6	5.2	95.0
100.0						7.4	6.6	7.0	6.2	6.6	6.0	5.0	4.4	4.2	100.0
105.0						6.4	5.6	6.0	5.2	5.6	5.0	4.2	3.4	3.2	105.0
110.0						5.6	4.8	5.2	4.4	4.6	4.2	3.2	2.6	2.4	110.0
115.0							4.0	4.4	3.6	3.8	3.4	2.4	1.8		115.0
120.0							2.8	3.6	2.8	3.2	2.6				120.0
125.0								3.0	2.2	2.4	2.0				125.0
130.0										2.0					130.0

\*\*Lifting loads > 206,000 lb can be lifted only with additional equipment



# Load charts

## Main boom

### Telescopic boom



12,8 - 60,0 m  
(42 - 197 ft)



7,6 m (25 ft)



360°



7,9 t (17,400 lb)



lb x 1000

ft	42.0	59.3	76.4	91.7	106.9	116.6	121.7	133.7	146.1	155.0	167.8	179.8	190.0	196.9	ft
10.0	**228.0	**228.0	197.0												10.0
15.0	174.0	174.0	165.0	142.0											15.0
20.0	126.0	121.0	112.0	102.0	92.0	79.0	88.0								20.0
25.0	80.0	85.0	81.0	79.0	72.0	68.0	65.0	63.0	58.0						25.0
30.0	55.0	61.0	63.0	60.0	55.0	54.0	50.0	49.0	48.0	46.0	42.0	35.0			30.0
35.0		46.0	48.0	47.0	47.0	43.4	42.8	39.6	41.4	39.4	36.2	34.4	28.0	26.0	35.0
40.0		35.4	38.0	38.6	38.6	36.6	35.2	32.4	34.2	33.2	32.0	29.4	28.0	26.0	40.0
45.0		28.0	30.6	33.0	32.4	32.0	29.6	28.2	29.0	28.6	27.0	24.8	23.6	23.0	45.0
50.0		17.8	25.4	27.2	27.4	27.4	25.2	25.6	24.6	24.4	23.0	21.0	20.0	19.4	50.0
55.0			21.0	22.8	23.0	23.8	21.6	22.4	21.2	21.0	19.8	18.0	17.0	16.4	55.0
60.0			17.6	19.4	19.8	20.4	18.6	19.6	18.4	18.2	17.2	15.4	14.6	14.0	60.0
65.0			9.8	16.4	17.0	17.4	16.0	17.0	15.8	15.8	14.8	13.2	12.4	11.8	65.0
70.0				14.0	14.6	15.0	13.6	14.6	13.8	13.8	12.8	11.4	10.6	10.0	70.0
75.0				12.0	12.6	13.0	11.6	12.6	11.8	12.0	11.2	9.8	9.0	8.4	75.0
80.0				6.0	10.8	11.2	9.8	10.8	10.0	10.4	9.8	8.4	7.6	7.2	80.0
85.0					9.2	9.6	8.4	9.4	8.6	8.8	8.4	7.2	6.4	6.0	85.0
90.0					8.0	8.4	7.0	8.0	7.2	7.6	7.0	6.0	5.2	4.8	90.0
95.0					6.8	7.2	5.8	6.8	6.0	6.4	5.8	5.0	4.2	3.8	95.0
100.0						6.2	4.8	5.8	5.0	5.4	4.8	3.8	3.2	3.0	100.0
105.0						5.2	4.0	4.8	4.0	4.4	3.8	3.0	2.4	2.0	105.0
110.0						4.4	3.2	4.0	3.2	3.6	3.0	2.2			110.0
115.0							2.4	3.4	2.6	2.8	2.2				115.0
120.0							1.8	2.6	1.8	2.2					120.0
125.0								2.0							125.0

\*\*Lifting loads > 206,000 lb can be lifted only with additional equipment



12,8 - 60,0 m  
(42 - 197 ft)



7,6 m (25 ft)



360°



5,6 t (12,300 lb)



lb x 1000

ft	42.0	59.3	76.4	91.7	106.9	116.6	121.7	133.7	146.1	155.0	167.8	179.8	190.0	196.9	ft
10.0	**228.0	**226.0	197.0												10.0
15.0	171.0	171.0	154.0	139.0											15.0
20.0	117.0	114.0	106.0	95.0	90.0	79.0	81.0								20.0
25.0	73.0	78.0	77.0	73.0	66.0	64.0	59.0	58.0	53.0						25.0
30.0	49.0	56.0	58.0	55.0	53.0	49.0	48.0	45.0	47.0	44.0	39.2	35.0			30.0
35.0		41.4	44.0	43.2	43.0	40.8	40.4	35.8	37.8	36.4	35.0	31.2	28.0	26.0	35.0
40.0		31.8	34.4	36.4	35.2	34.8	33.2	31.2	31.2	30.6	29.0	26.6	25.2	24.4	40.0
45.0		25.0	28.0	29.8	30.0	29.2	27.8	27.6	26.2	25.8	24.4	22.2	21.0	20.4	45.0
50.0		15.2	22.6	24.6	24.8	24.8	23.6	23.4	22.2	22.0	20.6	18.8	17.6	17.0	50.0
55.0			18.6	20.4	21.0	21.4	20.2	20.2	18.8	18.8	17.6	15.8	14.8	14.4	55.0
60.0			15.4	17.2	17.8	18.2	17.4	17.4	16.2	16.2	15.0	13.4	12.6	12.0	60.0
65.0			7.8	14.4	15.0	15.4	14.6	15.0	14.0	14.0	13.0	11.4	10.6	10.0	65.0
70.0				12.2	12.8	13.2	12.4	12.8	12.0	12.0	11.2	9.8	8.8	8.4	70.0
75.0				10.4	10.8	11.2	10.6	11.0	10.0	10.4	9.6	8.2	7.4	7.0	75.0
80.0				4.4	9.2	9.6	8.8	9.4	8.4	8.8	8.2	6.8	6.0	5.6	80.0
85.0					7.8	8.2	7.4	7.8	7.0	7.4	6.8	5.8	5.0	4.6	85.0
90.0					6.6	7.0	6.2	6.6	5.8	6.2	5.6	4.6	3.8	3.4	90.0
95.0					5.6	6.0	5.2	5.6	4.8	5.0	4.6	3.6	3.0	2.6	95.0
100.0						5.0	4.2	4.6	3.8	4.2	3.6	2.6	2.0	1.8	100.0
105.0						4.0	3.4	3.8	3.0	3.2	2.8	1.8			105.0
110.0						3.4	2.6	3.0	2.2	2.4	2.0				110.0
115.0							2.0	2.2							115.0

\*\*Lifting loads > 206,000 lb can be lifted only with additional equipment

# Load charts

## Main boom

### Telescopic boom

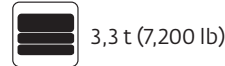
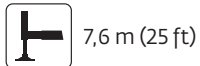
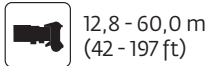

ft	42.0	59.3	76.4	91.7	106.9	116.6	121.7	133.7	146.1	155.0	167.8	179.8	190.0	196.9	ft
10.0	**228.0	**226.0	197.0												10.0
15.0	168.0	168.0	150.0	130.0											15.0
20.0	107.0	106.0	98.0	90.0	84.0	78.0	74.0								20.0
25.0	66.0	72.0	71.0	66.0	60.0	59.0	55.0	53.0	51.0						25.0
30.0	44.0	50.0	53.0	50.0	49.0	45.0	45.0	40.6	42.4	40.2	36.6	34.6			30.0
35.0		37.2	40.0	41.2	39.2	38.4	36.6	34.8	34.2	33.6	31.6	28.8	27.4	26.0	35.0
40.0		28.4	31.4	33.4	32.6	31.4	30.0	29.6	28.0	27.6	26.0	23.6	22.4	21.8	40.0
45.0		22.0	25.0	26.8	27.0	26.4	25.0	24.8	23.4	23.2	21.8	19.6	18.6	18.0	45.0
50.0		12.6	20.0	22.0	22.6	22.2	21.2	21.0	19.6	19.6	18.2	16.4	15.4	14.8	50.0
55.0			16.2	18.2	18.6	19.0	18.0	18.0	16.6	16.6	15.4	13.8	12.8	12.2	55.0
60.0			13.2	15.0	15.6	16.0	15.2	15.4	14.2	14.2	13.2	11.6	10.6	10.2	60.0
65.0			6.0	12.6	13.2	13.6	12.8	13.2	12.0	12.2	11.2	9.6	8.8	8.4	65.0
70.0				10.6	11.0	11.4	10.6	11.0	10.2	10.4	9.4	8.0	7.2	6.8	70.0
75.0				8.8	9.2	9.6	8.8	9.4	8.4	8.8	8.0	6.6	5.8	5.4	75.0
80.0				3.0	7.8	8.2	7.4	7.8	7.0	7.2	6.8	5.4	4.6	4.2	80.0
85.0					6.4	6.8	6.0	6.4	5.6	6.0	5.4	4.4	3.6	3.0	85.0
90.0					5.4	5.6	5.0	5.4	4.6	4.8	4.4	3.4	2.6	2.2	90.0
95.0					4.4	4.6	4.0	4.4	3.6	3.8	3.4	2.4			95.0
100.0						3.8	3.0	3.4	2.6	3.0	2.4				100.0
105.0						3.0	2.2	2.6	1.8	2.2					105.0
110.0						2.4	2.0								110.0

\*\*Lifting loads > 206,000 lb can be lifted only with additional equipment

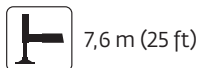
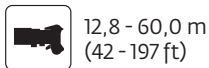

ft	42.0	59.3	76.4	91.7	106.9	116.6	121.7	133.7	146.1	155.0	167.8	179.8	190.0	196.9	ft
10.0	**228.0	**226.0	197.0												10.0
15.0	165.0	164.0	140.0	121.0											15.0
20.0	97.0	98.0	89.0	85.0	76.0	72.0	67.0								20.0
25.0	59.0	66.0	65.0	60.0	59.0	53.0	52.0	48.0	49.0						25.0
30.0	38.8	45.0	47.0	47.0	45.0	43.4	41.2	39.2	38.2	37.4	35.0	30.8			30.0
35.0		33.0	36.2	37.2	36.2	34.6	33.0	32.4	30.6	30.0	28.2	25.6	24.2	23.4	35.0
40.0		24.8	27.8	29.8	29.2	28.2	26.8	26.6	25.0	24.6	23.0	20.8	19.6	19.0	40.0
45.0		19.0	22.0	23.8	24.0	23.4	22.2	22.0	20.6	20.4	19.0	17.2	16.0	15.4	45.0
50.0		10.0	17.4	19.4	19.8	19.8	18.6	18.6	17.2	17.2	16.0	14.2	13.2	12.6	50.0
55.0			14.0	15.8	16.4	16.8	15.6	15.6	14.4	14.4	13.4	11.6	10.8	10.2	55.0
60.0			11.2	13.0	13.6	14.0	13.2	13.4	12.2	12.2	11.2	9.6	8.6	8.2	60.0
65.0			4.0	10.6	11.2	11.6	10.8	11.2	10.2	10.2	9.4	7.8	7.0	6.4	65.0
70.0				8.8	9.2	9.6	8.8	9.4	8.4	8.6	7.6	6.2	5.4	5.0	70.0
75.0				7.2	7.6	8.0	7.2	7.6	6.8	7.2	6.2	4.8	4.0	3.6	75.0
80.0					6.2	6.6	5.8	6.2	5.4	5.8	5.0	3.8	3.0	2.4	80.0
85.0					5.0	5.4	4.6	5.0	4.2	4.6	4.0	2.6	2.0		85.0
90.0					4.0	4.4	3.6	4.0	3.2	3.6	3.0	1.8			90.0
95.0					3.2	3.4	2.8	3.0	2.2	2.6	2.0				95.0
100.0						2.6	1.8	2.2		1.8					100.0
105.0						1.8									105.0

\*\*Lifting loads > 206,000 lb can be lifted only with additional equipment

# Working range

Main boom and bi-fold swingaway

## Working range



12,8 - 60,0 m  
(42 - 197 ft)



11,2/17,8/25,8 m  
(36 / 58 / 85 ft)



7,6 m  
(25 ft)



360°





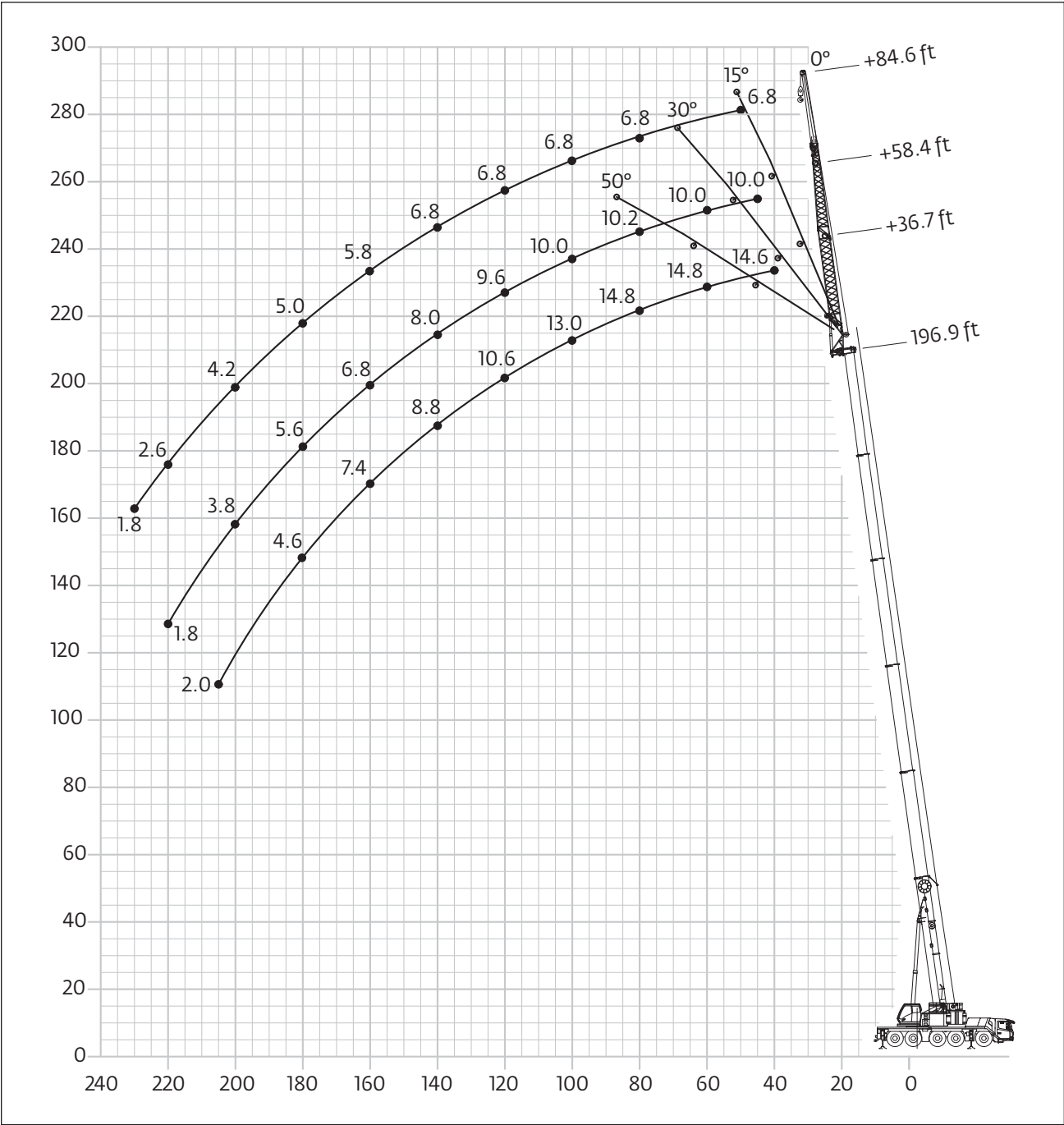

44,5 t  
(98,100 lb)





# Load chart

Main boom and bi-fold swingaway

## Swingaway (hydraulic luffing)

 12,8 - 60,0 m (42 - 197 ft)
  11,2 m (36 ft)
  7,6 m (25 ft)
  360°
  44,5 t (98,100 lb)

 lb x 1000

ft ft	42.0 36.7				121.7 36.7				179.8 36.7				196.9 36.7				ft ft
	0°	0°-15°	15°-30°	30°-50°	0°	0°-15°	15°-30°	30°-50°	0°	0°-15°	15°-30°	30°-50°	0°	0°-15°	15°-30°	30°-50°	
10.0	37.2																10.0
15.0	37.2																15.0
20.0	37.2	34.0															20.0
25.0	37.2	31.2	25.6		36.6												25.0
30.0	34.8	28.4	23.8	20.2	35.8												30.0
35.0	30.8	26.2	22.4	19.6	35.0	29.8			19.4								35.0
40.0	27.6	24.2	21.2	18.8	34.0	29.0	24.8		19.4				14.6				40.0
45.0	25.2	22.6	20.2	18.2	33.0	28.2	24.0		19.4				14.6				45.0
50.0	23.0	21.0	19.4	18.0	32.2	27.4	23.2	19.6	19.4	19.4			14.6	14.6			50.0
55.0	21.2	19.8	18.4		31.0	26.6	22.6	19.2	19.4	19.4	19.0		14.6	14.6			55.0
60.0	19.6	18.6	17.6		29.8	25.8	22.0	19.0	19.4	19.4	19.0	17.4	14.6	14.6	14.8		60.0
65.0	18.0	17.4	17.2		28.2	24.8	21.4	18.8	19.4	19.4	19.0	17.4	14.6	14.6	14.8		65.0
70.0	16.8	16.8			26.8	23.6	21.0	18.2	19.4	19.4	18.6	17.4	14.6	14.6	14.8	14.8	70.0
75.0					25.4	22.6	20.4	18.2	19.4	18.6	17.8	17.4	14.6	14.6	14.8	14.8	75.0
80.0					24.0	21.6	20.0	18.0	18.6	17.6	17.0	17.0	14.6	14.6	14.8	14.8	80.0
85.0					22.8	20.6	19.4	17.8	17.6	17.0	16.4	16.4	14.6	14.6	14.6	14.6	85.0
90.0					21.8	19.8	18.4	17.8	16.8	16.2	15.8	15.8	14.2	14.0	14.0	14.0	90.0
95.0					20.8	19.0	17.8	17.4	16.0	15.6	15.2	15.2	13.6	13.4	13.2	13.2	95.0
100.0					19.8	18.0	17.2	17.0	15.2	15.0	14.6	14.6	13.0	12.8	12.6	12.6	100.0
105.0					19.0	17.4	16.8	16.8	14.6	14.4	14.2	14.2	12.2	12.2	12.0	12.0	105.0
110.0					18.0	16.8	16.4	16.4	13.8	13.6	13.6	13.6	11.6	11.6	11.6	11.6	110.0
115.0					16.6	16.4	15.8		13.2	13.0	13.0	13.0	11.0	11.0	11.0	11.0	115.0
120.0					15.2	15.2	15.6		12.6	12.6	12.6	12.6	10.6	10.4	10.4	10.4	120.0
125.0					14.0	14.0	14.4		12.2	12.0	12.0	12.0	10.0	10.0	10.0	10.0	125.0
130.0					12.8	12.8	13.2		11.6	11.4	11.4	11.6	9.6	9.4	9.4	9.6	130.0
135.0					11.8	11.8	12.0		11.0	11.0	11.0	11.0	9.2	9.0	9.0	9.2	135.0
140.0					10.8	10.8			10.2	10.2	10.6	10.6	8.8	8.6	8.6	8.8	140.0
145.0					10.0	10.0			9.2	9.2	9.8	10.0	8.2	8.2	8.2	8.4	145.0
150.0					3.8	3.8			8.4	8.4	8.8	9.2	8.0	8.0	8.0	8.0	150.0
155.0									7.6	7.6	8.0		7.4	7.4	7.6	7.6	155.0
160.0									6.8	6.8	7.2		6.6	6.6	7.0	7.4	160.0
165.0									6.2	6.2	6.4		6.0	6.0	6.4		165.0
170.0									5.4	5.4	5.8		5.4	5.4	5.6		170.0
175.0									4.8	4.8	5.2		4.6	4.6	5.0		175.0
180.0									4.4	4.4	4.6		4.2	4.2	4.4		180.0
185.0									3.8	3.8	4.0		3.6	3.6	3.8		185.0
190.0									3.4	3.4	3.4		3.0	3.0	3.4		190.0
195.0									2.8	2.8			2.6	2.6	2.8		195.0
200.0									2.4	2.4			2.2	2.2	2.4		200.0
205.0									2.0	2.0			1.8	1.8			205.0

# Load chart

## Main boom and bi-fold swingaway

### Swingaway (hydraulic luffing)



12,8 - 60,0 m  
(42 - 197 ft)



17,8 m (58 ft)



7,6 m  
(25 ft)



360°



44,5 t  
(98,100 lb)







lb x 1000



ft ft	42.0 58.4				121.7 58.4				179.8 58.4				196.9 58.4				ft ft
	0°	0°-15°	15°-30°	30°-50°	0°	0°-15°	15°-30°	30°-50°	0°	0°-15°	15°-30°	30°-50°	0°	0°-15°	15°-30°	30°-50°	
10.0																	10.0
15.0	18.8																15.0
20.0	18.8																20.0
25.0	18.8																25.0
30.0	17.8	15.8			17.0												30.0
35.0	17.0	15.0			16.8												35.0
40.0	16.0	14.2	12.8		16.4				12.2								40.0
45.0	15.2	13.6	12.0		16.2	14.4			12.2				10.0				45.0
50.0	14.4	13.0	11.4	10.0	15.8	14.0			12.2				10.0				50.0
55.0	13.6	12.2	10.8	9.6	15.6	13.8	12.2		12.2				10.0				55.0
60.0	13.0	11.6	10.4	9.4	15.2	13.4	12.0		12.0	11.4			10.0	10.0			60.0
65.0	12.2	11.0	10.0	9.2	15.0	13.2	11.6		12.0	11.4			10.0	10.0			65.0
70.0	11.4	10.4	9.6	9.0	14.6	12.8	11.4	9.6	11.8	11.4			10.0	10.0			70.0
75.0	10.8	10.0	9.4	9.0	14.2	12.6	11.0	9.6	11.8	11.2	10.8		10.0	10.0			75.0
80.0	10.2	9.6	9.2		14.0	12.4	10.8	9.4	11.8	11.2	10.6		10.0	10.0	10.2		80.0
85.0	9.6	9.2	9.0		13.6	12.0	10.6	9.2	11.6	11.0	10.6		10.0	10.0	10.2		85.0
90.0	9.2	9.0			13.2	11.8	10.4	9.2	11.6	11.0	10.4	9.2	10.0	10.0	10.2	9.2	90.0
95.0					13.0	11.6	10.2	9.2	11.6	11.0	10.4	9.2	10.0	10.0	10.0	9.2	95.0
100.0					12.6	11.2	10.0	9.0	11.4	10.8	10.2	9.2	10.0	10.0	10.0	9.2	100.0
105.0					12.4	11.0	9.8	9.0	11.4	10.8	10.2	9.0	10.0	10.0	10.0	9.0	105.0
110.0					12.2	10.6	9.6	9.0	11.2	10.6	10.0	9.0	10.0	10.0	9.8	9.0	110.0
115.0					11.8	10.4	9.4	9.0	11.2	10.6	9.8	9.0	10.0	10.0	9.8	9.0	115.0
120.0					11.4	10.2	9.4	9.0	11.0	10.4	9.6	9.0	9.6	9.4	9.4	9.0	120.0
125.0					11.2	10.0	9.2	9.0	10.8	10.2	9.6	8.8	9.0	9.0	9.0	8.8	125.0
130.0					10.8	9.8	9.0	9.0	10.4	10.0	9.4	8.8	8.6	8.6	8.6	8.8	130.0
135.0					10.6	9.6	9.0		10.0	9.8	9.2	8.8	8.2	8.2	8.2	8.4	135.0
140.0					10.2	9.4	9.0		9.6	9.4	9.2	8.8	7.8	7.8	8.0	8.0	140.0
145.0					10.0	9.2	9.0		9.2	9.0	9.0	8.8	7.6	7.6	7.6	7.6	145.0
150.0					9.8	9.2	9.0		8.8	8.8	8.8	8.8	7.2	7.2	7.2	7.4	150.0
155.0					9.4	9.2	9.0		8.4	8.4	8.4	8.4	6.8	6.8	7.0	7.0	155.0
160.0					8.8	8.8			7.8	7.8	8.2	8.2	6.6	6.6	6.6	6.8	160.0
165.0					8.0	8.0			7.0	7.0	7.8	8.0	6.2	6.2	6.4	6.4	165.0
170.0					7.4	7.4			6.4	6.4	7.0	7.6	6.0	6.0	6.0	6.2	170.0
175.0									5.8	5.8	6.4	6.8	5.6	5.6	5.8	6.0	175.0
180.0									5.2	5.2	5.8		5.0	5.0	5.6	5.6	180.0
185.0									4.6	4.6	5.2		4.4	4.4	5.0	5.4	185.0
190.0									4.2	4.2	4.6		3.8	3.8	4.4	4.8	190.0
195.0									3.6	3.6	4.0		3.4	3.4	4.0		195.0
200.0									3.2	3.2	3.6		3.0	3.0	3.4		200.0
205.0									2.8	2.8	3.2		2.6	2.6	3.0		205.0
210.0									2.4	2.4			2.2	2.2	2.4		210.0
215.0									2.0	2.0					2.0		215.0

# Load chart

Main boom and bi-fold swingaway

## Swingaway (hydraulic luffing)

 12,8 - 60,0 m (42 - 197 ft)
  25,8 m (85 ft)
  7,6 m (25 ft)
  360°
  44,5 t (98,100 lb)

 lb x 1000

ft ft	42.0 84.6				121.7 84.6				179.8 84.6				196.9 84.6				ft ft
	0°	0°-15°	15°-30°	30°-50°	0°	0°-15°	15°-30°	30°-50°	0°	0°-15°	15°-30°	30°-50°	0°	0°-15°	15°-30°	30°-50°	
10.0																	10.0
15.0																	15.0
20.0	13.2																20.0
25.0	12.8																25.0
30.0	12.4				11.2												30.0
35.0	12.0				11.2												35.0
40.0	11.6	10.8			11.0												40.0
45.0	11.2	10.2			10.8				7.8								45.0
50.0	10.8	9.6			10.8				7.8				6.8				50.0
55.0	10.4	9.2			10.6				7.8				6.8				55.0
60.0	9.8	8.6	7.8		10.4	9.6			7.8				6.8				60.0
65.0	9.2	8.2	7.4		10.2	9.2			7.8				6.8				65.0
70.0	8.8	7.8	7.0		10.2	9.0			7.6				6.8				70.0
75.0	8.2	7.4	6.8	6.2	10.0	8.8	7.4		7.6	7.4			6.8	6.8			75.0
80.0	7.8	7.2	6.6	6.0	9.8	8.4	7.2		7.6	7.4			6.8	6.8			80.0
85.0	7.4	6.8	6.4	5.8	9.6	8.2	7.2		7.6	7.2			6.8	6.8			85.0
90.0	7.0	6.6	6.0	5.6	9.4	8.0	7.0	6.0	7.6	7.2			6.8	6.8			90.0
95.0	6.8	6.2	6.0	5.6	9.2	7.8	6.8	6.0	7.4	7.2	6.8		6.8	6.8			95.0
100.0	6.4	6.0	5.8	5.6	8.8	7.6	6.6	5.8	7.4	7.2	6.6		6.8	6.8	6.4		100.0
105.0	6.2	6.0	5.6		8.6	7.4	6.6	5.8	7.4	7.2	6.6	5.8	6.8	6.6	6.4		105.0
110.0	6.0	5.8	5.6		8.4	7.2	6.4	5.8	7.4	7.0	6.4	5.8	6.8	6.6	6.4		110.0
115.0	5.6	5.6			8.2	7.0	6.2	5.6	7.2	7.0	6.4	5.6	6.8	6.6	6.2	5.6	115.0
120.0	5.4	5.4			7.8	6.8	6.2	5.6	7.2	7.0	6.2	5.6	6.8	6.6	6.2	5.6	120.0
125.0					7.6	6.8	6.0	5.6	7.2	6.8	6.2	5.6	6.8	6.6	6.0	5.6	125.0
130.0					7.4	6.6	6.0	5.6	7.2	6.8	6.0	5.6	6.8	6.6	6.0	5.6	130.0
135.0					7.2	6.4	5.8	5.6	7.2	6.6	6.0	5.6	6.8	6.6	6.0	5.6	135.0
140.0					7.0	6.2	5.8	5.4	7.2	6.6	6.0	5.6	6.8	6.4	5.8	5.4	140.0
145.0					6.8	6.2	5.8	5.4	7.0	6.4	5.8	5.4	6.6	6.4	5.8	5.4	145.0
150.0					6.6	6.0	5.6	5.4	7.0	6.4	5.8	5.4	6.2	6.2	5.8	5.4	150.0
155.0					6.6	6.0	5.6	5.4	7.0	6.2	5.8	5.4	6.0	6.0	5.8	5.4	155.0
160.0					6.4	5.8	5.6		6.8	6.2	5.6	5.4	5.8	5.8	5.6	5.4	160.0
165.0					6.2	5.8	5.6		6.8	6.0	5.6	5.4	5.4	5.4	5.6	5.4	165.0
170.0					6.0	5.8	5.4		6.4	6.0	5.6	5.4	5.2	5.2	5.4	5.4	170.0
175.0					6.0	5.8	5.4		6.2	6.0	5.6	5.4	5.0	5.0	5.0	5.2	175.0
180.0					5.8	5.6	5.4		5.6	5.6	5.6	5.4	4.8	4.8	4.8	5.0	180.0
185.0					5.8	5.6			5.0	5.0	5.4	5.4	4.6	4.6	4.6	4.8	185.0
190.0					5.6	5.6			4.4	4.4	5.4	5.4	4.2	4.2	4.4	4.6	190.0
195.0					5.4	5.4			4.0	4.0	4.8	5.4	3.6	3.6	4.2	4.4	195.0
200.0									3.6	3.6	4.2	4.8	3.2	3.2	4.0	4.2	200.0
205.0									3.0	3.0	3.8		2.8	2.8	3.6	4.0	205.0
210.0									2.6	2.6	3.2		2.4	2.4	3.0	3.6	210.0
215.0									2.2	2.2	2.8		2.0	2.0	2.6	3.2	215.0
220.0									1.8	1.8	2.4				2.2		220.0
225.0											2.0				1.8		225.0

**The lifting capacities correspond to ASME 30.5**

The lifting capacities likewise fulfill the requirements of SAEJ1289 and ISO 4305 with regard to stability.

The lifting capacities are given in 1,000 lb.

Lifting capacity = Payload + weight of hook block and suspending device.

The lifting capacities for the main boom only apply with the jib dismantled.

Lifting capacities > 98t (206,000 lb) require additional equipment.

Lifting capacities > 130 t (286,600 lb) require special equipment.

The right is reserved to modify the load-carrying capacities.

**Note: The details in this brochure serve only as general information. The determinant values for the operation of the crane are the lifting capacity tables belonging to it and the operating instructions.**

Lifting capacities are indicated by boom length for different levels of extension. The actual boom length will be in accordance with the selected configuration for boom extension.

## Superstructure



### Boom

12,8 m to 60,0 m (42 - 197 ft) six section TWIN-LOCK™ boom. Maximum tip height 63,0 m (207 ft).



### Boom elevation

1 cylinder with safety valve, boom angle from -1,5° to +83°.



### Load moment an independent anti-two block system

Load moment and independent anti-two block system with audio visual warning and control lever lock-out. These systems provide graphic display of boom angle, length, radius, tip height, relative load moment, maximum permissible load, load indication and warning of impending two-block condition with lock-out hoist function.



### Cab

Aluminium, full vision, tiltable (approx. 20°), safety glass, adjustable operator's seat with suspension, engine-independent heater. Armrest-integrated crane controls. Ergonomically arranged instrumentation and crane operating controls.



### Slewing

2 slewing gears with axial piston motors, planetary gears, automatic break.



### Counterweight

44,5 tonnes (98,100 lb), consisting of various sections (30,9 t within 2,75 m [68,100 lb within 9 ft] vehicle width). Hydraulic removal system.



### Hydraulic system

2 separate circuits, 1 axial piston variable displacement pump with electronic power limiting control and 1 axial piston variable displacement pump for slewing. Thermostatically controlled oil cooler. Tank capacity: 750 l (198 gal).



### Control system

Full electronic control of all crane movements using electrical control levers with automatic reset to zero. Integrated with the RCL and engine management system by CAN-BUS. Crane Control System (CCS) with system with graphic display.



### Hoist

Axial piston motor with planetary gear and brake. Drum rotation indicator. IR - Hoist camera.

### \* Optional equipment

- Bi-fold swingaway 11,2/17,8 m (36 / 58 ft) - with hydraulic offset and luffing under load (0° - 50°), controlled from the crane cab.
- 8 m (26 ft) boom and 8 m (26 ft) jib extensions (maximum total length 33,8 m [111 ft]).
- Auxiliary hoist (in lieu of compensation counterweight).
- Auxiliary boom nose using two parts of line.
- Air-conditioning system.

## Carrier



### Chassis

Special 5-axle chassis, all-welded torsion-resistant box type construction in high strength steel.



### Outriggers

4 double hydraulically telescoping beams with vertical cylinders and outrigger pads. Independent horizontal and vertical movement control on each side of the carrier and from the operators cab. Electronic level indicator with automatic levelling system. Spotlight for each outrigger beam integrated in carrier decking.



### Engine

Mercedes Benz OM471LA, diesel, 6 cylinders, water cooled, turbocharged, 390 kW (522 HP) at 1700 rpm (80/1269 EWG fan loose). Max. torque: 2460 Nm (1814 ft lb) at 1300 rpm. Fuel tank: 325 l + 325 l (86 + 86 gal). Engine emission: Euromot 4 / EPA / CARB Tier 4 final (non road).



### Transmission

Mercedes G 280-16 gears forward and 2 reverse. 2-stage transfer case with longitudinal differential lock.



### Drive/Steer

10 x 6 x 10.



### Axle lines

5 axle lines, axle lines 1, 2, 3, 4 and 5 steered, axle line 2, 4 and 5 driven.



### Suspension

MEGATRAK®. All wheels with independent hydropneumatic suspension and hydraulic lockout. Longitudinal and transverse level control with automatic on highway levelling system. Range +195 mm/-105 mm (+7.7 in / -4.1 in). Active suspension control on outrigger control units.



### Tires

10 tires, 385/95 R25 (14.00 R25).



### Steering

Dual circuit, hydraulic power assisted steering with emergency steering pump. Axle lines 1, 2, 3, 4 and 5 steer on highway. Separate electronic hydraulic (steer by wire) steering of the 3rd, 4th and 5th axle line for all wheel steering and crabbing.



### Brakes

Service brake: pneumatic dual circuit disc brakes acting on all wheels, air dryer. Permanent brake: exhaust brake and constant throttle brake. Parking brake: pneumatically operated spring-loaded brake acting on axle lines 2, 3, 4 and 5.



### Driver's Cab

Two operator designed, safety glass, driver seat with pneumatic suspension, engine-independent diesel air heater incl. 24 h timer. Complete instrumentation and driving controls. Air conditioning. 12 V plug. Fire extinguisher.



### Electrical system

Three-phase alternator 28 V/150A, 2 batteries 12 V/180 Ah. Lighting system and signals 24 V.

### \* Optional equipment

- 10 x 8 x 10
- 10 tires, size 445/95 R25 (16.00 R25) - Vehicle width 2,75 m (9 ft).
- 10 tires, size 525/80 R25 (20.5 R25) - Vehicle width 2,88 m (9.45 ft).
- Folding bunk bed in carrier cab.
- Secondary water retarder.
- Reverse camera system.

\* Other optional equipment on request.

# Symbols glossary



Axles



Counterweight



Main hoist



Outriggers



Axle load



Crane functions



Auxiliary hoist



Radius



Boom



Crane travel



Hookblock / Capacity



Slewing/  
Working range



Boom elevation



Drive/Steer



Hydraulic system



Speed



Boom telescoping



Electrical system



Lattice extension



Suspension



Brakes



Engine



Lattice extension  
(luffing)



Transmission / Gear



Cab



Free on wheels



Luffing Jib



Travel speed



Carrier frame



Gradeability



Low range



Tires



Hose reel



Swing-Away



Dolly



Storage box +  
rigging gear



Weight per axle in kg



Driveline



Brackets





# Notes



## Manitowoc Cranes

### Regional headquarters

#### Americas

**Manitowoc, Wisconsin, USA**

Tel: +1 920 684 6621

Fax: +1 920 683 6277

**Shady Grove, Pennsylvania, USA**

Tel: +1 717 597 8121

Fax: +1 717 597 4062

#### Europe and Africa

**Dardilly, France - TOWERS**

Tel: +33 (0)4 72 18 20 20

Fax: +33 (0)4 72 18 20 00

**Wilhelmshaven, Germany - MOBILE**

Tel: +49 (0) 4421 294 0

Fax: +49 (0) 4421 294 4301

#### China

**Shanghai, China**

Tel: +86 21 6457 0066

Fax: +86 21 6457 4955

#### Middle East and Greater Asia-Pacific

**Singapore**

Tel: +65 6264 1188

Fax: +65 6862 4040

**Dubai, UAE**

Tel: +971 4 8862677

Fax: +971 4 8862678/79



**Manitowoc**  
Crane Care™



**Manitowoc**  
Finance™



This document is non-contractual. Constant improvement and engineering progress make it necessary that we reserve the right to make specification, equipment, and price changes without notice. Illustrations shown may include optional equipment and accessories and may not include all standard equipment.