

Grove GMK5165-2

Product Guide

ASME B30.5
Imperial 85%



Features

- 130 t (165 USt) capacity
- 12,9 m - 60 m (42 ft - 197 ft) six-section full power MEGAFORM™ boom with TWIN-LOCK™ pinning
- 11 m - 18 m (36 ft - 59 ft) bi-fold lattice swingaway, hydraulic luffing or manual offset
- 3,6 m (12 ft) three-sheave heavy duty jib, hydraulic luffing integrated in swingaway
- 375 kW (503 hp) Mercedes OM 502 LA 8-cylinder turbo-charged diesel engine. Daimler Chrysler, 16-speed G240-16 transmission. Two-stage transfer case
- MEGATRAK™ independent hydro-pneumatic suspension

Features

MEGATRAK™

The MEGATRAK™ suspension system is the best off road driveline available on the market today. The system's versatility and performance allows the GMK5135 to operate as a true all-terrain crane. The MEGATRAK™ independent suspension and all-wheel steer system allows wheels to remain on the ground at all times so stresses and weight are not continually transferred between axles. MEGATRAK™ provides true ground clearance where others just raise the chassis.

Other benefits of the MEGATRAK™ system are:

- A reliable suspension system
- Excellent job site maneuverability with all-wheel steering
- Commonality among almost all models
- A driveline that remains aligned at all times
- A steering linkage system that is protected against damage
- Constant tire contact for equal tire wear
- Reduced maintenance

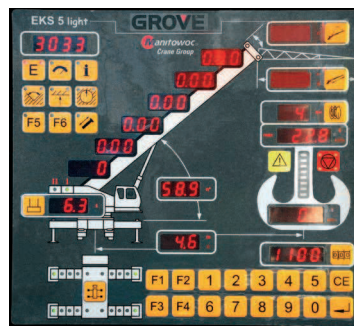

EKS 5 Light

Monitoring the lifting condition of the crane at all times EKS works together with, but independently of the ECOS as a complete command and control system or separately as a load moment indicator.

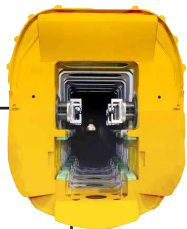

TWIN-LOCK™

Boom pinning mechanism automatically pins the sections in position using two horizontal pins.



CraneSTAR

CraneSTAR is an exclusive and innovative crane asset management system that helps improve your profitability and reduce costs by remotely monitoring critical crane data. Visit www.cranestar.com for more information.

ECOS

Electronic Crane Operating System - ECOS enables control of the entire crane's principle operations. Simple programming eases lift planning and a supply of essential information allows full concentration on the lift itself.



Contents

Specifications	4
Dimensions	7
Weight proposals	8
Counterweight	9
Working range (main boom)	10
Load charts (main boom)	11
Working range (swingaway and inserts)	13
Load charts (hydraulically offsettable swingaway)	14
Working range (heavy duty jib)	16
Load charts (heavy duty jib)	17
Symbols glossary	19

Specifications

Superstructure



Boom

12,9 m - 60,0 m (42 ft - 197 ft) six-section, full power MEGAFORM™ boom with patented TWIN-LOCK™ boom pinning system.

Maximum tip height: 63 m (207 ft).



Boom nose

Eight nylatron sheaves, mounted on heavy duty tapered roller bearings with removable pin-type rope guards. Quick reeve boom nose. Removable auxiliary boom nose with removable pin type rope guard.



Boom elevation

Single lift cylinder with safety valve provides boom angle from -3° to +83°.



Hydraulic offsettable lattice extension

11 m - 18 m (36 ft - 59 ft) bi-fold lattice swingaway extension **hydraulically offsettable** and luffing under load: 0° - 40°. Controlled from the crane cab. Maximum tip height: 81 m (266 ft)



*Offsettable lattice extension

11 m - 18 m (36 ft - 59 ft) bi-fold lattice swingaway extension manually offset: 0°, 20° or 40°. Maximum tip height: 81 m (266 ft)



Lattice inserts

One 8 m (26 ft) and one 6 m (20 ft) insert for use with lattice swingaway extension. Increases extension length to 26 m (85 ft) or 32 m (105 ft).



Load moment and anti-two block system

Load moment and anti-two block system with audio/visual warning and control lever lockout provides electronic display of boom angle, length, radius, tip height, relative load moment, maximum permissible load, load indication and warning of impending two-block condition.



Cab

All aluminum construction cab with acoustical lining, tinted safety glass, adjustable operator's seat, opening windows in side and cab rear, hinged front window with wiper, sun visor and window shade. Other features include hot water heater, armrest integrated crane controls, and ergonomically arranged instrumentation.



Crane control system

Full electronic control of all crane movements using electrical control levers with automatic reset to zero. Controls are integrated with the LMI and engine management system by CAN-BUS. ECOS system with graphic display.



Swing

Two planetary gears with axial piston motors. Infinitely variable to 1.5 rpm. Holding and service brake.



Counterweight

40 100 kg (88,400 lb) consisting of various sections with hydraulic installation/removal system. Controlled from the superstructure cab.



Engine

Mercedes-Benz OM 924 LA four-cylinder, turbo charged diesel engine 129 kW (173 bhp). Stainless steel exhaust on Tier 4i.

Engine emission: EUROMOT 3b/EPA/CARB/Tier 4i off-highway. (EUROMOT/EPA/CARB Tier III (non-road) available for outside North America.



Fuel tank capacity

200 L (53 gal)



Hydraulic system

Two separate circuits, one axial piston variable displacement pump (load sensing) with electronic power limiting control and one gear pump for swing. Dual thermostatically controlled oil coolers keep oil at optimum operating temperature. Tank capacity: 840 L (222 gal)

Specifications

Superstructure continued

Hoist

Main and auxiliary hoists are powered by axial piston motor with planetary gear and brake. “Thumb-thumper” hoist drum rotation indicator alerts operator of hoist movement.

	Main	Auxiliary
Line length:	255 m (837 ft)	225 m (738 ft)
Rope diameter:	19 mm	19 mm
Line speed:	120 m/min (394 fpm)	120 m/min (394 fpm)
Line pull:	70 kN (15,700 lb)	70 kN (15,700 lb)



Electrical system

24V system with three phase alternator, 28V/80A. 2 batteries, 12V/170 Ah.

*Optional hook blocks

Lifting capacity	Sheaves	Weight	Parts of line	Possible load with the crane*
100 t (110 USt)	7	1150 kg (2535 lb)	2-15	100 t (110 USt)
75 t (83 USt)	5	850 kg (1873 lb)	2-11	75 t (83 USt)
50 t (55 USt)	3	675 kg (1488 lb)	1-7	49 t (54 USt)
20 t* (22 USt)	1	325 kg (716 lb)	1-3	20 t (22 USt)
8 t** (8.8 USt)	H/B	200 kg (440 lb)	1	7 t (7.7 USt)

* Required for overhaul of single part line with boom/jib lengths in excess of 60 m (196.9 ft)

**Overhaul weight designed for a maximum of 60 m (196.9 ft) boom/jib lengths

*Optional equipment

- ▶ 3,6 m (11.8 ft) side-stowed three-sheave heavy-duty jib integrated in swingaway.
- ▶ Work light, mounted on top of base section.
- ▶ Cab controlled work lights mounted to top of base section.
- ▶ Stainless steel exhaust system with spark arrestor in lieu of standard.
- ▶ Engine independent diesel cab heater, also serves as engine pre-heater including 24-hour timer.

- ▶ Engine independent propane gas cab heater.
- ▶ Stereo/radio CD player.
- ▶ Outrigger pad load indicator with readout both in superstructure cab and carrier.
- ▶ Air conditioning.
- ▶ Working range limiter.
- ▶ Boom mounted aircraft warning light.
- ▶ Drive and steer control for superstructure.
- ▶ EKS5 with full graphic display.

Carrier



Chassis

Box type, torsion resistant frame is fabricated from high strength steel.



Outrigger system

Four hydraulic single stage outrigger beams with vertical cylinders and outrigger pads, 600 mm (23.6 in) square. Outriggers can be set in five positions:

Full:	7,5 m (24.6 ft)
Partial:	6,7 m (22.0 ft)
	5,9 m (19.4 ft)
	5,1 m (16.7 ft)
Retracted:	2,5 m (8.2 ft)

Independent horizontal and vertical movement controlled from each side of carrier. Electronic crane level indicators. Includes outrigger monitoring system.



Engine

Mercedes-Benz OM 502 LA eight cylinder, water cooled, turbo-charged, with 375 kW (503 bhp) at 1800 rpm. Max. torque 2400 Nm (1770 ft/lb) at 1300 rpm.

Engine emissions: EUROMOT/EPA/CARB Tier 4i (non-road)

Compression and exhaust brakes.



Fuel tank capacity

400 L (106 gal)



Transmission

Daimler Chrysler, 16 speed G240-16 with EPS (Electric Pneumatic Shifting) and two-stage transfer case.

Specifications

Carrier continued



Drive/steer

10x6x10



Axles

1st axle line – steer

2nd axle line – drive/steer

3rd axle line – steer (additional drive)

4th axle line – drive/steer (connects for all wheel steer)

5th axle line – drive/steer

Drive axles with planetary hub reduction and center mounted differential-gearing. Inter-axle and cross axle differential locks.



Suspension

Exclusive MEGATRAK™ suspension. Independent hydro-pneumatic system acting on all wheels with hydraulic lockout. Suspension can be raised 170 mm (6.5 in) or lowered 130 mm (5 in) both longitudinally and transversely. Features an automatic leveling system for highway travel.



Tires

10 tires, 445/95 R25 (16.00 R25).

Vehicle width 3,00 m (9.8 ft)



Steering

Dual circuit, hydraulic power assisted steering system. Transfer case mounted, ground driven emergency steering pump. Axles 1, 2, 3 and 5 steer on highway. Separate steering of the 4th and 5th axles for all wheel and crab steering, controlled by an electronic rocker switch.



Brakes

Service brakes: pneumatic dual circuit acting on all wheels, anti lock prevention.

Parking brake: pneumatically operated spring loaded brake acting on axle lines 2, 4 and 5.

Air dryer.



Cab

Two-man construction with the following features: safety glass, driver seat with suspension, power windows, heated rear view mirrors, engine independent diesel cab heater with 24-hour timer, AC, complete instrumentation and driving controls.

ECOS control of suspension, drive connect and disconnect, inter-axle locks, differential locks and all-wheel steer.



Electrical system

24V system with three phase alternator, 28V/100A 2 batteries, 12V/170 Ah



Maximum speed

85 km/h (53 mph)



Gradeability (theoretical)

60% - 14.00 R25 tires

54% - 16.00/20.5 R25 tires

Miscellaneous standard equipment

Work light; tool kit; fire extinguisher; auxiliary boom nose; radio/CD player in carrier cab, cruise control, wind speed indicator and working lights for each outrigger beam, CraneSTAR asset management system.

*Optional equipment

- ▶ Stainless steel exhaust system with spark arrestor
- ▶ 385/95 R25 tires (14.00 R25) (vehicle width, 2,75 m [9 ft])
- ▶ 525/80 R25 tires (20.5 R25) (vehicle width, 3,1 m [10.2 ft])
- ▶ 10x8x10 drive/steer
- ▶ Electric driveline retarder
- ▶ Steel outrigger floats
- ▶ Spare tire with carry bracket
- ▶ Outrigger pad load indicator
- ▶ Hinged bunk bed
- ▶ Trailer and towing hitches
- ▶ Additional strobe lights
- ▶ Rear mounted stowage box
- ▶ Optional engine: Tier III Mercedes-Benz OM 502 LA, 390 Kw (513 bhp) at 1800 rpm. Max torque 2400 Nm at 1300 rpm (non-road)

Weight proposals

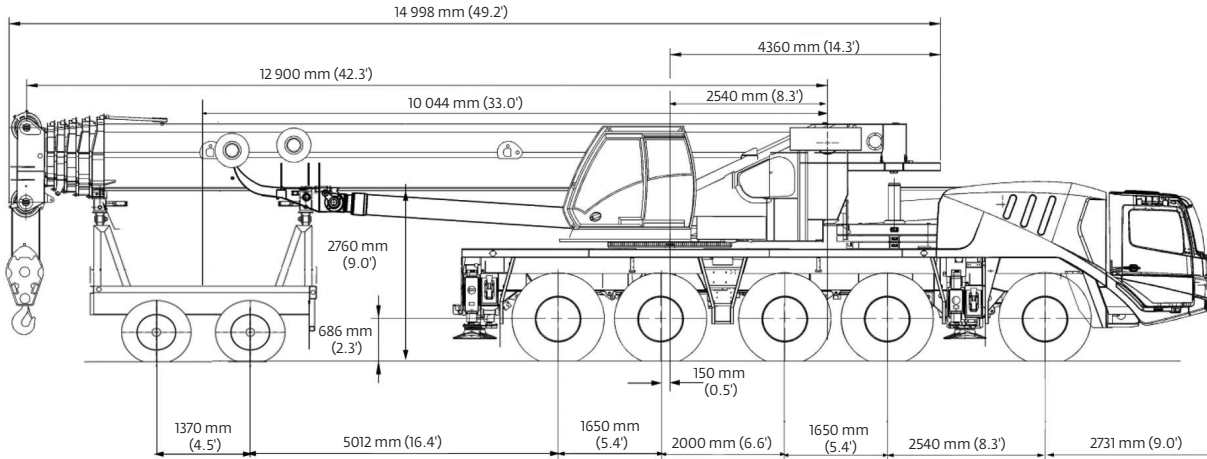

Basic weights - kg (lb)	Axles 1 and 2		Axles 3-5		2 Dolly axles		Total	
GMK5165-2 Mercedes-Benz power Tier 4i with: 16.00R25 tires, 10x8x10 drive/steer, 36 ft - 59 ft hydraulic luffing swingaway, 2nd oil cooler, outrigger pads, auxiliary hoist, driver and tanks filled, 2 axle boom dolly (2994 kg [6600 lb])	18 251	(40,237)	22 269	(49,093)	14 343	(31,620)	54 863	(120,950)
Additions:								
2500 kg (5500 lb) section on superstructure or carrier (1,2,5,7)	1896	(4180)	604	(1332)			2500	(5512)
5000 kg (11,000 lb) section stowed on carrier (3,4)	3792	(8360)	1208	(2663)			5000	(11,023)
2 x 3750 kg (2 x 8300 lb) section stowed on carrier (8+9)	5689	(12,542)	1811	(3993)			7500	(16,535)
Removals:								
Brackets for hydraulic swingaway	-13	(-29)	-12	(-26)	-61	(-134)	-86	(-190)
Hose reel + parts for hydraulic swingaway	-7	(-15)	-6	(-13)	-196	(-432)	-210	(-463)
11 m - 18 m (36 ft - 59 ft) hydraulic swingaway	-197	(-434)	-171	(-377)	-1376	(-3034)	-1744	(-3845)
Front outriggers	-1379	(-3040)	-6	(-13)			-1385	(-3053)
Rear outriggers	926	(2041)	-2400	(-5291)			-1474	(-3250)
Front and rear outrigger floats	-37	(-82)	-163	(-359)			-200	(-441)
Substitutions:								
10x6x10 drive/steer	-43	(-95)	-65	(-143)			-108	(-238)
14.00R25 tires	-240	(-529)	-360	(-794)			-600	(-1323)
16.00R25 tires	172	(379)	258	(569)			430	(948)

Boom over front								
Basic weights - kg (lb)	Axles 1 and 2		Axles 3-5		Total			
GMK5165-2 Mercedes-Benz power Tier 4i with: 16.00R25 tires, 10x6x10 drive/steer, 2nd oil cooler, outrigger pads, auxiliary hoist, driver and tanks filled, 20 t hook block on bumper	19 990	(44,070)	29 922	(65,967)	49 912	(110,037)		
Additions:								
10x8x10 drive/steer	43	(95)	65	(143)	108	(238)		
Electric driveline retarder	-74	(-163)	334	(736)	260	(573)		
Spare wheel 14.00 R25 XGC steel rim with stowage	-198	(-437)	457	(1008)	259	(571)		
Spare wheel 16.00 R25 XGC steel rim with stowage	-244	(-538)	563	(1241)	319	(703)		
Spare wheel 20.5 R25 XGC steel rim with stowage	-277	(-611)	639	(1409)	362	(798)		
Brackets for hydraulic swingaway	82	(181)	4	(9)	86	(190)		
Hose reel + parts for hydraulic swingaway	301	(664)	-91	(-201)	210	(463)		
11 m - 18 m (36 ft - 59 ft) hydraulic swingaway	1968	(4339)	-224	(-494)	1744	(3845)		
Auxiliary boom nose	149	(328)	-79	(-174)	70	(154)		
5000 kg (11,000 lb) slab fixed to turntable (special counterweight version)	-2759	(-6083)	7759	(17,106)	5000	(11,023)		
2500 kg (5500 lb) section pinned to superstructure (5,7)	-1862	(-4105)	4362	(9617)	2500	(5512)		
2500 kg (5500 lb) section stowed on carrier (1,2)	1896	(4180)	604	(1332)	2500	(5512)		
5000 kg (11,000 lb) section stowed on carrier (3,4)	3793	(8362)	1207	(2661)	5000	(11,023)		
2 x 3760 kg (2 x 8300 lb) section stowed on carrier (8,9)	5689	(12,542)	1811	(3993)	7500	(16,535)		
Substitutions:								
14.00R25 tires	-240	(-529)	-360	(-794)	-600	(-1323)		
20.5R25 tires	172	(379)	258	(569)	430	(948)		
Removals:								
Boom assembly	-11 677	(-25,743)	-3541	(-7807)	-15 218	(-33,550)		
Front outriggers	-1379	(-3040)	-6	(-13)	-1385	(-3053)		
Rear outriggers	926	(2041)	-2400	(-5291)	-1474	(-3250)		
Front and rear outrigger floats	-37	(-82)	-163	(-359)	-200	(-441)		

Counterweight

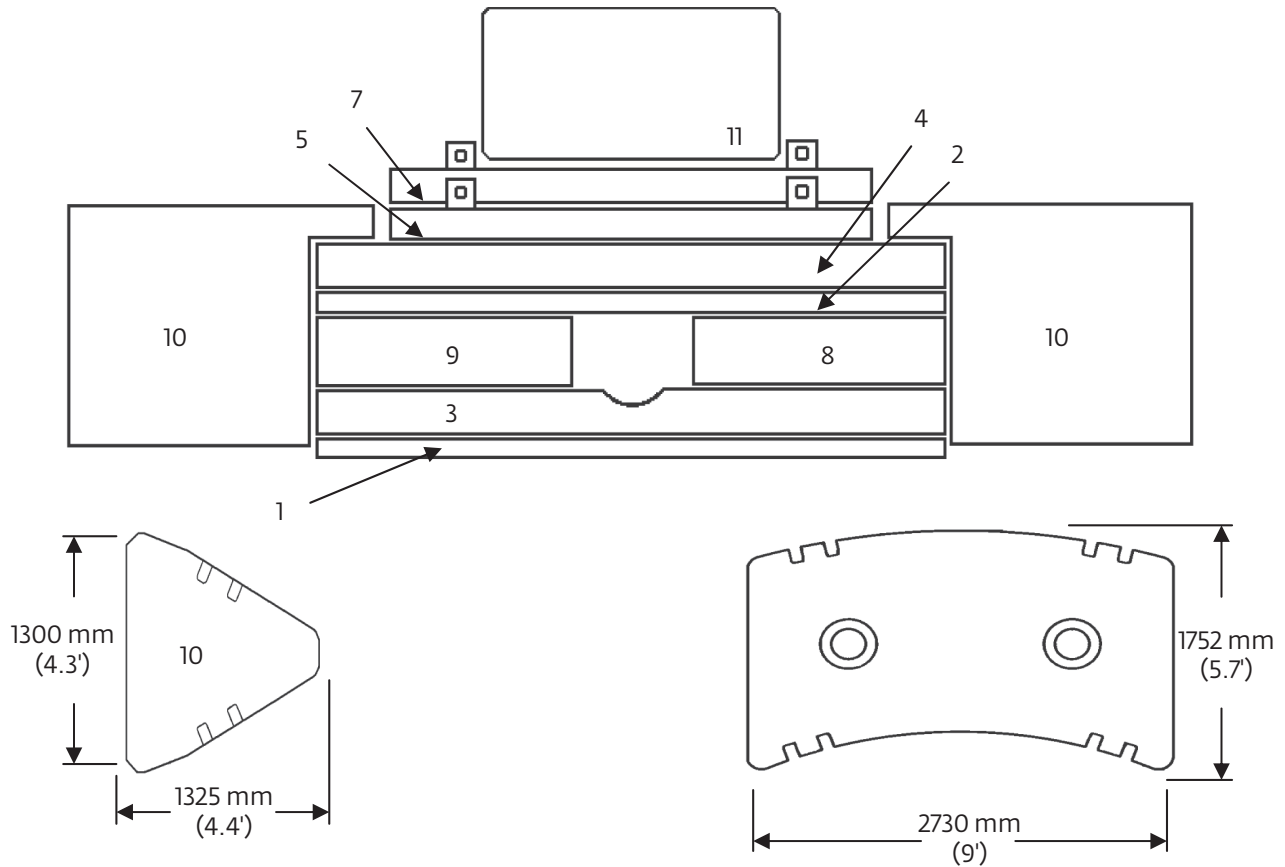







- | | |
|---------------------------------|---|
| 1. 2500 kg (5500 lb) baseplate | 7. 2500 kg (5500 lb) pinned |
| 2. 2500 kg (5500 lb) stacking | 8. 3750 kg (8300 lb) stacking |
| 3. 5000 kg (11,000 lb) stacking | 9. 3750 kg (8300 lb) stacking |
| 4. 5000 kg (11,000 lb) stacking | 10. 5770 kg (12,700 lb) wing |
| 5. 2500 kg (5500 lb) pinned | 11. 1000 kg (2200 lb) bolted (auxiliary hoist or IPO) |

	1	2	3	4	5	7	8	9	10	11
Counterweight configuration kg (lb)										
1000 (2200)										•
3500 (7700)						•				•
6000 (13,200)					•	•				•
8500 (18,700)	•				•	•				•
11 000 (24,200)	•						•	•		•
13 500 (29,700)	•					•	•	•		•
16 000 (35,200)	•				•	•	•	•		•
18 500 (40,700)	•		•			•	•	•		•
21 000 (46,200)	•		•		•	•	•	•		•
23 500 (51,800)	•	•	•		•	•	•	•		•
26 000 (57,300)	•		•	•	•	•	•	•		•
28 500 (62,800)	•	•	•	•	•	•	•	•		•
40 100 (88,400)	•	•	•	•	•	•	•	•	2x	•

Load charts





Main boom









Pounds x 1000

Feet	42.3	58.0	73.8	89.1	104.5	119.6	135.3	150.9	166.4	181.7	196.9
8.0	330.0*										
10.0	215.0	199.0	186.0	143.0							
15.0	168.0	165.0	154.0	143.0	110.0						
20.0	136.0	137.0	132.0	125.0	108.0	84.0	62.0	45.0			
25.0	113.0	114.0	114.0	110.0	98.0	78.0	62.0	45.0	35.2		
30.0	92.0	96.0	96.0	95.0	90.0	72.0	61.0	45.0	35.2	25.6	22.0
35.0		83.0	83.0	82.0	82.0	66.0	56.0	45.0	35.2	25.6	22.0
40.0		72.0	72.0	71.0	72.0	60.0	51.0	45.0	35.2	25.6	22.0
45.0		61.0	63.0	62.0	62.0	56.0	47.0	41.4	35.2	25.6	22.0
50.0			56.0	56.0	54.0	52.0	42.6	38.4	34.8	25.6	22.0
55.0			48.0	50.0	47.0	48.0	39.2	35.6	32.4	25.6	22.0
60.0				43.6	41.8	42.4	35.8	32.8	29.8	25.6	22.0
65.0				38.4	37.6	38.0	32.6	29.8	27.8	25.6	22.0
70.0				34.2	35.4	34.2	30.2	27.4	25.8	24.4	21.6
75.0				27.4	32.2	31.0	28.0	25.4	24.0	23.0	20.6
80.0					29.0	27.8	26.4	23.8	22.2	21.4	19.6
85.0					26.4	25.0	25.2	22.0	20.8	20.0	18.6
90.0					23.8	22.4	24.0	20.8	19.4	18.8	17.8
95.0						21.0	21.8	19.0	18.2	17.6	17.0
100.0						20.0	19.8	17.2	17.0	16.4	16.0
105.0							18.0	15.8	15.6	15.0	14.8
110.0							16.6	14.8	14.2	13.8	13.6
115.0							15.2	14.0	13.0	12.8	12.8
120.0								13.4	11.6	12.0	12.0
125.0								12.8	10.4	11.6	11.4
130.0								12.4	9.8	11.0	10.8
135.0								11.4	9.4	10.4	10.0
140.0									8.8	10.0	9.2
145.0									8.4	9.4	8.4
150.0									8.0	8.6	7.6
155.0										7.8	6.8
160.0										7.2	6.2
165.0											5.6
170.0											5.0
175.0											4.4
180.0											3.8

*Over rear with special equipment







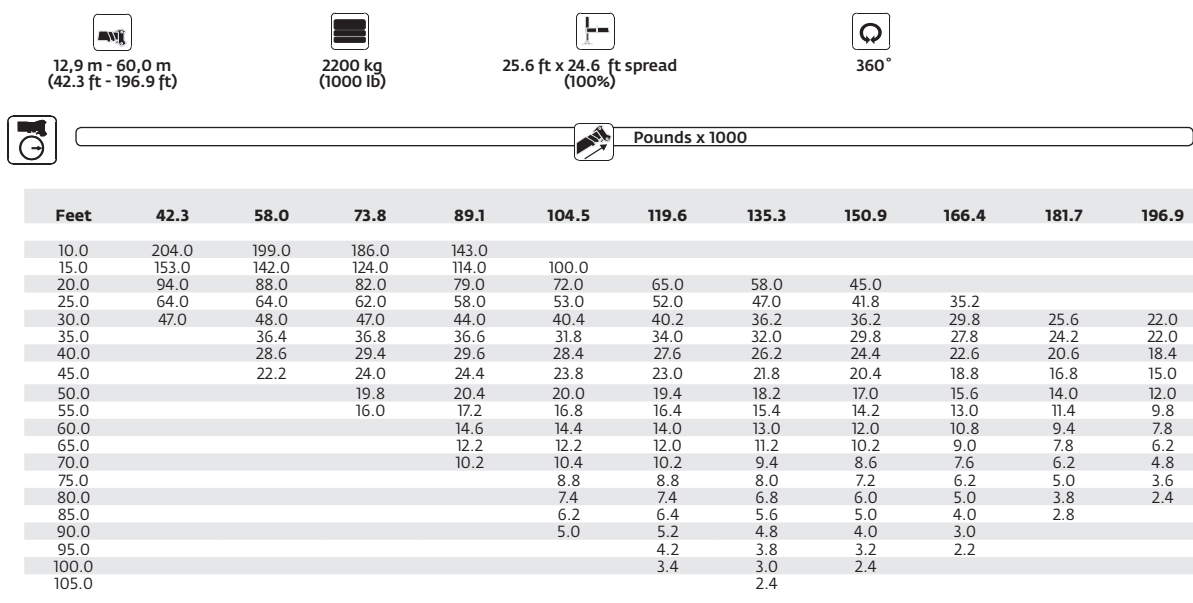
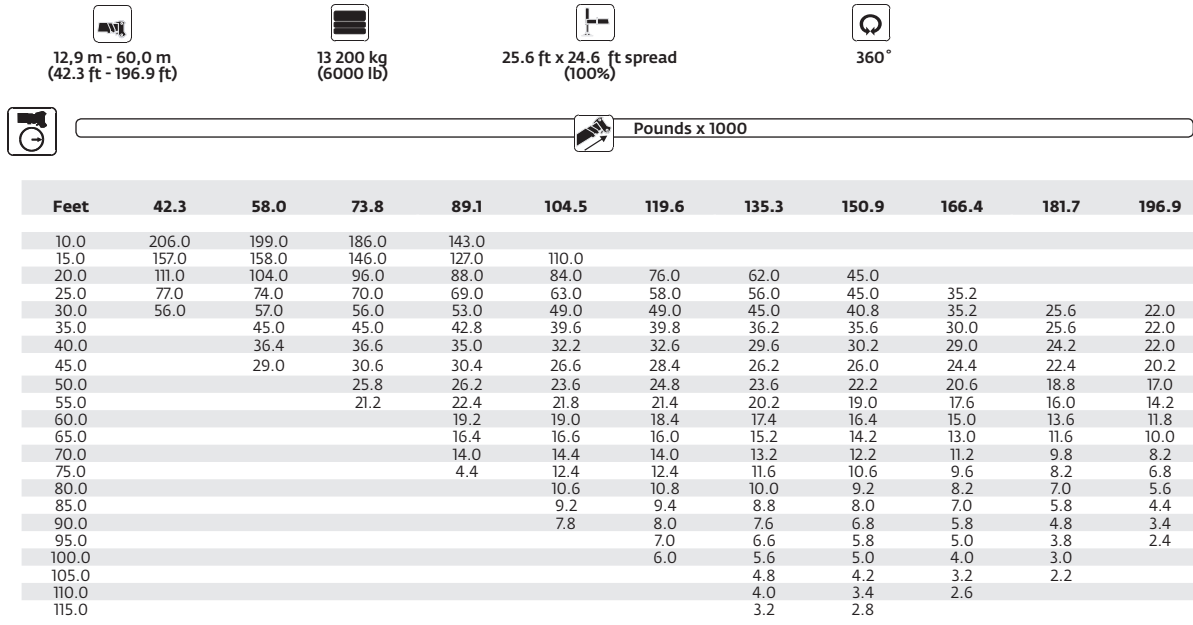

Pounds x 1000

Feet	42.3	58.0	73.8	89.1	104.5	119.6	135.3	150.9	166.4	181.7	196.9
10.0	210.0	199.0	186.0	143.0							
15.0	164.0	164.0	154.0	143.0	110.0						
20.0	130.0	131.0	131.0	125.0	108.0	84.0	62.0	45.0			
25.0	107.0	108.0	101.0	93.0	90.0	78.0	62.0	45.0	35.2		
30.0	85.0	86.0	78.0	76.0	71.0	70.0	61.0	45.0	35.2	25.6	22.0
35.0		69.0	65.0	62.0	61.0	57.0	54.0	45.0	35.2	25.6	22.0
40.0		55.0	55.0	52.0	52.0	48.0	45.0	43.0	35.2	25.6	22.0
45.0		47.0	47.0	45.0	44.0	41.0	41.0	36.8	35.2	25.6	22.0
50.0			40.0	40.6	38.2	35.6	35.8	31.6	31.0	25.6	22.0
55.0			35.2	35.4	33.4	32.8	31.4	28.2	26.8	25.6	22.0
60.0				30.8	29.4	30.0	27.6	26.4	23.4	23.8	22.0
65.0				26.8	26.0	26.8	24.4	24.6	21.6	22.4	21.2
70.0				23.6	22.8	24.0	21.8	22.0	20.2	20.6	19.0
75.0				15.2	20.0	21.6	19.4	19.6	19.0	18.4	16.8
80.0					17.6	19.2	17.4	17.8	17.8	16.6	15.0
85.0					15.6	17.0	15.6	16.0	16.2	14.8	13.4
90.0					13.8	15.2	14.0	14.4	14.6	13.4	12.0
95.0						13.6	12.4	13.2	13.2	12.0	10.6
100.0						12.8	11.0	12.4	12.0	10.8	9.4
105.0							10.4	11.6	11.0	9.8	8.4
110.0							9.8	10.4	9.8	8.8	7.4
115.0							9.2	9.4	8.8	7.8	6.6
120.0								8.4	7.8	7.0	5.8
125.0								7.6	7.0	6.2	5.0
130.0								6.8	6.2	5.4	4.2
135.0								6.2	5.4	4.6	3.6
140.0									4.8	4.0	3.0
145.0									4.2	3.4	2.4
150.0									3.6	2.8	
155.0										2.2	

Load charts

Main boom



Working range

42 ft - 197 ft main boom with hydraulic 36 ft and 59 ft swingaway, 1x26 ft and 1x20 ft insert

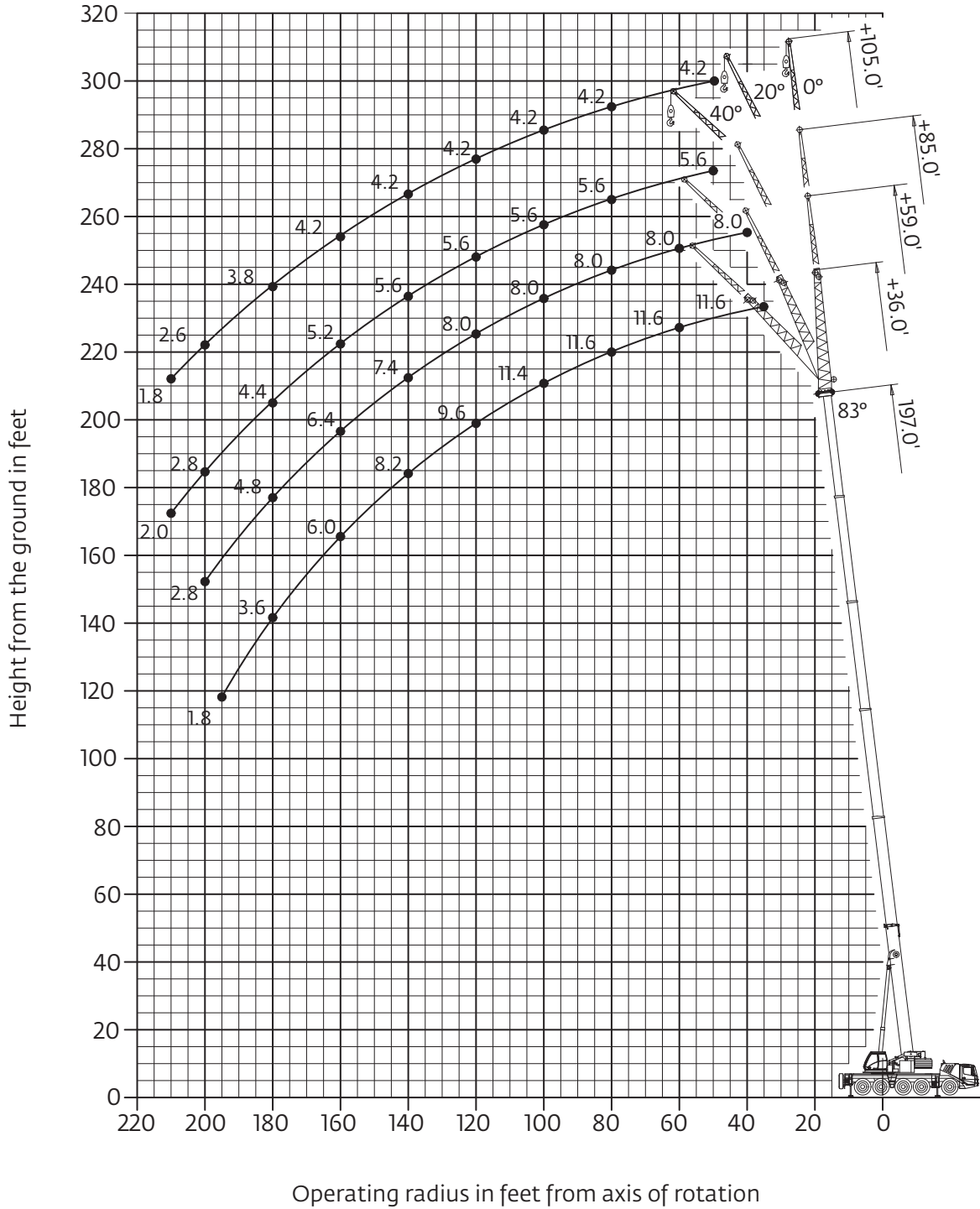







Hook heights shown in the working range diagram do not consider loaded boom deflection.







Load charts

Hydraulic offsettable swingaway

Intermediate angle

    												
 												
Feet	197' + 36'			197' + 59'			197' + 85'			197' + 105'		
	0°	0°-20°	20°-40°	0°	0°-20°	20°-40°	0°	0°-20°	20°-40°	0°	0°-20°	20°-40°
30.0												
35.0												
40.0	11.6			8.0								
45.0	11.6			8.0								
50.0	11.6	11.6		8.0			5.6			4.2		
55.0	11.6	11.6	11.6	8.0			5.6			4.2		
60.0	11.6	11.6	11.6	8.0	8.0		5.6			4.2		
65.0	11.6	11.6	11.6	8.0	8.0		5.6			4.2		
70.0	11.6	11.6	11.6	8.0	8.0		5.6	5.6		4.2		
75.0	11.6	11.6	11.6	8.0	8.0		5.6	5.6		4.2	4.2	
80.0	11.6	11.6	11.6	8.0	8.0	8.0	5.6	5.6		4.2	4.2	
85.0	11.6	11.6	11.6	8.0	8.0	8.0	5.6	5.6		4.2	4.2	
90.0	11.6	11.6	11.6	8.0	8.0	8.0	5.6	5.6	5.6	4.2	4.2	4.0
95.0	11.6	11.6	11.6	8.0	8.0	8.0	5.6	5.6	5.6	4.2	4.2	4.0
100.0	11.4	11.4	11.4	8.0	8.0	8.0	5.6	5.6	5.6	4.2	4.2	4.0
105.0	11.0	10.8	11.0	8.0	8.0	8.0	5.6	5.6	5.6	4.2	4.2	4.0
110.0	10.6	10.4	10.6	8.0	8.0	8.0	5.6	5.6	5.6	4.2	4.2	4.0
115.0	10.0	10.0	10.0	8.0	8.0	8.0	5.6	5.6	5.6	4.2	4.2	4.0
120.0	9.6	9.6	9.6	8.0	8.0	8.0	5.6	5.6	5.6	4.2	4.2	4.0
125.0	9.2	9.2	9.2	8.0	8.0	8.0	5.6	5.6	5.6	4.2	4.2	4.0
130.0	8.8	8.8	8.8	7.8	7.8	8.0	5.6	5.6	5.6	4.2	4.2	4.0
135.0	8.4	8.4	8.6	7.4	7.6	7.8	5.6	5.6	5.6	4.2	4.2	4.0
140.0	8.0	8.0	8.2	7.2	7.2	7.4	5.6	5.6	5.6	4.2	4.2	4.0
145.0	7.6	7.6	7.8	6.8	7.0	7.2	5.6	5.6	5.6	4.2	4.2	4.0
150.0	6.8	6.8	7.4	6.6	6.6	6.8	5.4	5.4	5.6	4.2	4.2	4.0
155.0	6.2	6.2	6.8	6.4	6.4	6.6	5.0	5.2	5.6	4.2	4.2	4.0
160.0	5.6	5.6	6.0	6.0	6.2	6.4	4.8	5.0	5.2	4.0	4.2	4.0
165.0	5.0	5.0	5.4	5.6	5.6	6.2	4.6	4.8	5.0	3.8	4.0	4.0
170.0	4.4	4.4	4.8	5.0	5.0	5.8	4.4	4.6	4.8	3.6	3.8	4.0
175.0	3.8	3.8	4.2	4.6	4.6	5.4	4.2	4.4	4.6	3.4	3.6	4.0
180.0	3.2	3.2	3.6	4.0	4.0	4.8	3.8	3.8	4.4	3.2	3.4	3.8
185.0	2.8	2.8		3.6	3.6	4.2	3.4	3.4	4.2	3.0	3.2	3.6
190.0	2.4	2.4		3.0	3.0	3.8	3.0	3.0	3.6	2.8	2.8	3.4
195.0	1.8	1.8		2.6	2.6	3.2	2.6	2.6	3.2	2.4	2.4	3.0
200.0				2.2	2.2	2.8	2.2	2.2	2.8	2.0	2.0	2.6
205.0									2.4			2.2
210.0									2.0			1.8

Loads for luffing

    												
 												
Feet	197' + 36'		197' + 59'		197' + 85'		197' + 105'					
	0°-20°	20°-40°	0°-20°	20°-40°	0°-20°	20°-40°	0°-20°	20°-40°	0°-20°	20°-40°		
40.0												
45.0												
50.0	11.2											
55.0	11.2	11.2										
60.0	11.2	11.2	7.2									
65.0	11.2	11.2	7.2									
70.0	11.2	11.2	7.2				5.6					
75.0	11.2	11.2	7.2				5.6			4.2		
80.0	11.2	11.2	7.2	7.2			5.6			4.2		
85.0	11.2	11.2	7.2	7.2	7.2		5.6			4.2		
90.0	11.2	11.2	7.2	7.2	7.2		5.6	5.6		4.2	3.8	
95.0	11.2	11.2	7.2	7.2	7.2		5.6	5.6		4.2	3.8	
100.0	10.8	10.8	7.2	7.2	7.2		5.6	5.6		4.2	3.8	
105.0	10.4	10.4	7.2	7.2	7.2		5.6	5.6		4.2	3.8	
110.0	9.8	10.0	7.2	7.2	7.2		5.6	5.6		4.2	3.8	
115.0	9.4	9.6	7.2	7.2	7.2		5.6	5.6		4.2	3.8	
120.0	9.0	9.2	7.2	7.2	7.2		5.6	5.6		4.2	3.8	
125.0	8.6	8.8	7.2	7.2	7.2		5.6	5.6		4.2	3.8	
130.0	8.4	8.4	7.2	7.2	7.2		5.6	5.6		4.2	3.8	
135.0	8.0	8.2	7.2	7.2	7.2		5.6	5.6		4.2	3.8	
140.0	7.6	7.8	6.8	7.2	7.2		5.6	5.6		4.2	3.8	
145.0	7.0	7.4	6.6	6.8	6.8		5.4	5.6		4.2	3.8	
150.0	6.4	6.8	6.4	6.6	6.6		5.2	5.4		4.2	3.8	
155.0	5.6	6.2	6.0	6.4	6.4		5.0	5.2		4.2	3.8	
160.0	5.0	5.6	5.8	6.0	6.0		4.8	5.0		4.0	3.8	
165.0	4.4	4.8	5.2	5.8	5.8		4.6	4.8		3.8	3.8	
170.0	4.0	4.4	4.6	5.4	5.4		4.4	4.6		3.6	3.8	
175.0	3.4	3.8	4.2	5.0	5.0		4.2	4.4		3.4	3.8	
180.0	3.0	3.2	3.6	4.4	4.4		3.6	4.2		3.4	3.6	
185.0	2.6		3.2	3.8	3.8		3.2	4.0		3.2	3.4	
190.0	2.2		2.8	3.4	3.4		2.8	3.4		2.8	3.2	
195.0			2.4	3.0	3.0		2.4	3.0		2.4	3.0	
200.0			2.0	2.6	2.6		2.0	2.6		2.0	2.6	
205.0								2.2				2.2

THIS CHART IS ONLY A GUIDE AND SHOULD NOT BE USED TO OPERATE THE CRANE.

The individual crane's load chart, operating instructions and other instructional plates must be read and understood prior to operating the crane

Load charts

Hydraulic offsettable swingaway

Intermediate angle



60 m
(197 ft)



11-18-26-32 m
(36-59-85-105 ft)



21 000 kg
(46,200 lb)



25.6 ft x 24.6 ft spread
100%



360°



Pounds x 1000

Feet	197' + 36'			197' + 59'			197' + 85'			197' + 105'			
	0°	0°- 20°	20°- 40°	0°	0°- 20°	20°- 40°	0°	0°- 20°	20°- 40°	0°	0°- 20°	20°- 40°	
30.0													
35.0	11.6												
40.0	11.6			8.0									
45.0	11.6			8.0									
50.0	11.6	11.6		8.0				5.6			4.2		
55.0	11.6	11.6	11.6	8.0				5.6			4.2		
60.0	11.6	11.6	11.6	8.0	8.0			5.6			4.2		
65.0	11.6	11.6	11.6	8.0	8.0			5.6			4.2		
70.0	11.6	11.6	11.6	8.0	8.0			5.6	5.6		4.2		
75.0	11.6	11.6	11.6	8.0	8.0			5.6	5.6		4.2	4.2	
80.0	11.6	11.6	11.6	8.0	8.0	8.0		5.6	5.6		4.2	4.2	
85.0	11.6	11.6	11.6	8.0	8.0	8.0		5.6	5.6		4.2	4.2	
90.0	10.6	10.6	11.6	8.0	8.0	8.0		5.6	5.6	5.6	4.2	4.2	4.0
95.0	9.4	9.4	10.4	8.0	8.0	8.0		5.6	5.6	5.6	4.2	4.2	4.0
100.0	8.2	8.2	9.2	8.0	8.0	8.0		5.6	5.6	5.6	4.2	4.2	4.0
105.0	7.2	7.2	8.2	7.8	7.8	8.0		5.6	5.6	5.6	4.2	4.2	4.0
110.0	6.2	6.2	7.2	6.8	6.8	8.0		5.6	5.6	5.6	4.2	4.2	4.0
115.0	5.4	5.4	6.2	6.0	6.0	7.6		5.6	5.6	5.6	4.2	4.2	4.0
120.0	4.6	4.6	5.4	5.2	5.2	6.8		5.0	5.0	5.6	4.2	4.2	4.0
125.0	3.8	3.8	4.6	4.6	4.6	6.0		4.2	4.2	5.6	4.0	4.0	4.0
130.0	3.2	3.2	4.0	3.8	3.8	5.2		3.6	3.6	5.0	3.4	3.4	4.0
135.0	2.6	2.6	3.2	3.2	3.2	4.4		3.0	3.0	4.2	2.8	2.8	4.0
140.0	2.0	2.0	2.6	2.6	2.6	3.8		2.4	2.4	3.6	2.2	2.2	3.6
145.0			2.0	2.2	2.2	3.2		2.0	2.0	3.0			3.0
150.0						2.6				2.6			2.4
155.0						2.2				2.0			

Loads for luffing



60 m
(197 ft)



11-18-26-32 m m
(36-59-85-105 ft)



21 000 kg
(46,200 lb)



25.6 ft x 24.6 ft spread
100%



360°



Pounds x 1000

Feet	197' + 36'		197' + 59'		197' + 85'		197' + 105'		
	0°-20°	20°-40°	0°-20°	20°-40°	0°-20°	20°-40°	0°-20°	20°-40°	
40.0									
45.0									
50.0	11.2								
55.0	11.2	11.2							
60.0	11.2	11.2	7.2						
65.0	11.2	11.2	7.2						
70.0	11.2	11.2	7.2			5.6			
75.0	11.2	11.2	7.2			5.6		4.2	
80.0	11.2	11.2	7.2	7.2		5.6		4.2	
85.0	11.2	11.2	7.2	7.2		5.6		4.2	
90.0	10.6	11.2	7.2	7.2		5.6		4.2	3.8
95.0	9.4	10.4	7.2	7.2		5.6	5.6	4.2	3.8
100.0	8.2	9.2	7.2	7.2		5.6	5.6	4.2	3.8
105.0	7.2	8.2	7.2	7.2		5.6	5.6	4.2	3.8
110.0	6.2	7.2	6.8	7.2		5.6	5.6	4.2	3.8
115.0	5.4	6.2	6.0	7.2		5.6	5.6	4.2	3.8
120.0	4.6	5.4	5.2	6.8		5.0	5.6	4.2	3.8
125.0	3.8	4.6	4.6	6.0		4.2	5.6	4.0	3.8
130.0	3.2	4.0	3.8	5.2		3.6	5.0	3.4	3.8
135.0	2.6	3.2	3.2	4.4		3.0	4.2	2.8	3.8
140.0	2.0	2.6	2.6	3.8		2.4	3.6	2.2	3.6
145.0		2.0	2.2	3.2		2.0	3.0		3.0
150.0				2.6			2.6		2.4
155.0				2.2			2.0		

THIS CHART IS ONLY A GUIDE AND SHOULD NOT BE USED TO OPERATE THE CRANE.

Grove GMK5165-2 The individual crane's load chart, operating instructions and other instructional plates must be read and understood prior to operating the crane

Courtesy of Crane.Market

Working range

42 ft - 197 ft main boom with 12 ft integrated heavy duty jib

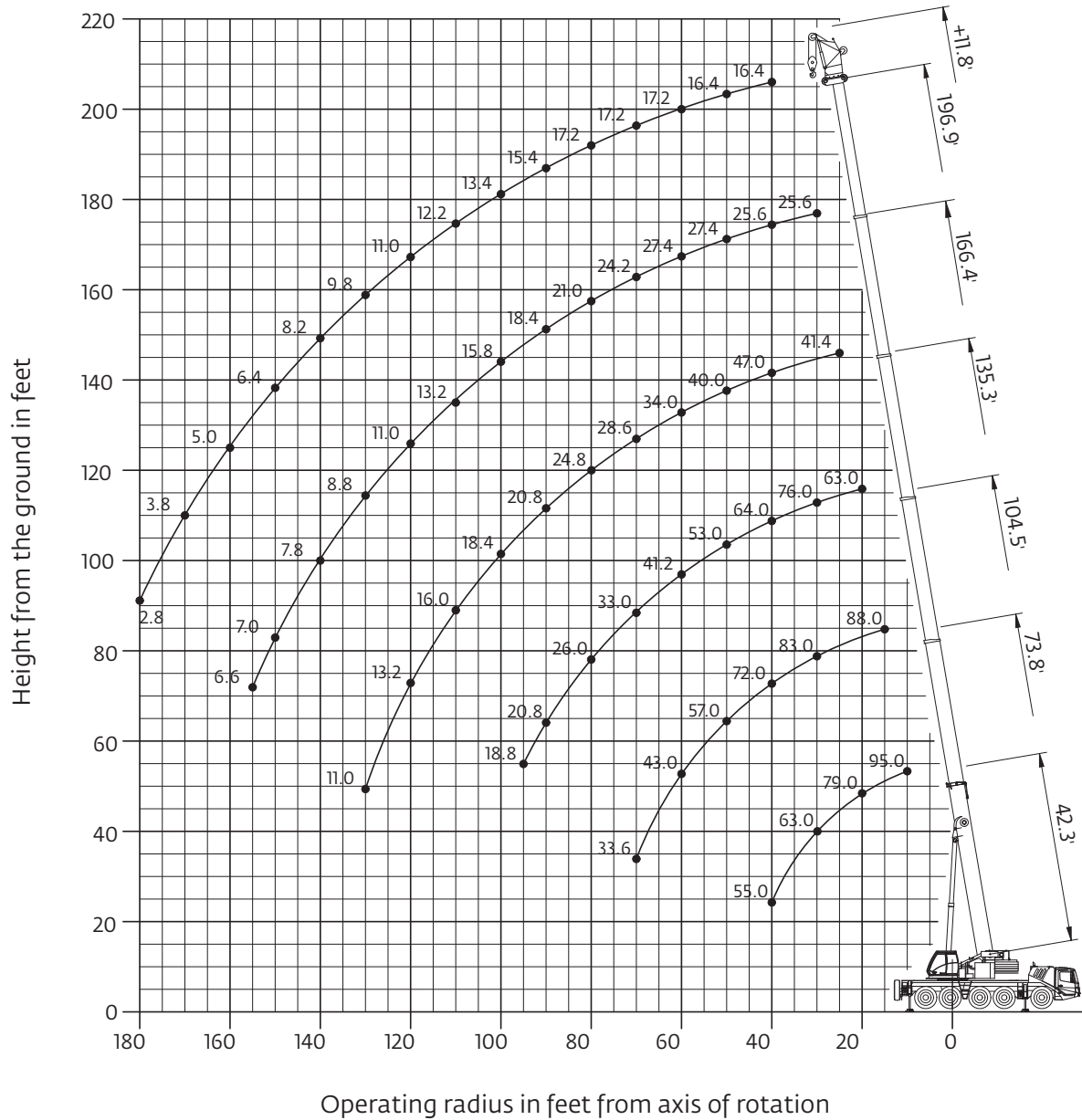

Hook heights shown in the working range diagram do not consider loaded boom deflection.

THIS CHART IS ONLY A GUIDE AND SHOULD NOT BE USED TO OPERATE THE CRANE.

The individual crane's load chart, operating instructions and other instructional plates must be read and understood prior to operating the crane.

Courtesy of Crane.Market

Load charts

Integrated heavy duty jib

Intermediate angle







12,9 m - 60,0 m (42.3 - 196.9 ft)
 3,6 m (11.8 ft)
 40 100 kg (88,400 lb)
 25.6 ft x 24.6 ft spread 100%
 360°

Feet	42.3' + 11.8'						73.8' + 11.8'			104.5' + 11.8'			135.3' + 11.8'			166.4' + 11.8'			196.9' + 11.8'				
	0°		<20°		<40°		0°		<20°		<40°	0°		<20°		<40°	0°		<20°		<40°		
	0°	<20°	<40°	0°	<20°	<40°	0°	<20°	<40°	0°	<20°	<40°	0°	<20°	<40°	0°	<20°	<40°	0°	<20°	<40°		
10.0	95.0	95.0	88.0																				
15.0	91.0	87.0	85.0			88.0																	
20.0	79.0	78.0	78.0	95.0	93.0	88.0				63.0													
25.0	70.0	70.0	71.0	91.0	87.0	85.0				63.0					41.4								
30.0	63.0	63.0		83.0	81.0	81.0			76.0	66.0	63.0				41.4					25.6			
35.0	59.0	59.0		76.0	76.0	76.0			70.0	66.0	63.0				41.4					25.6			
40.0	55.0			71.0	71.0	72.0			64.0	64.0	63.0		47.0	41.4	41.4					25.6		16.4	
45.0				64.0	64.0	64.0			59.0	59.0	59.0		43.2	41.4	41.4		27.4	25.6	25.6			16.4	
50.0				57.0	57.0	57.0			53.0	53.0	53.0		40.0	39.8	39.8		27.4	25.6	25.6			16.4	
55.0				49.0	49.0				46.0	46.0	47.0		36.8	36.8	37.0		27.4	25.6	25.6		17.2	16.4	16.4
60.0				43.0	43.0				41.0	41.0	41.2		34.0	34.0	34.0		27.4	25.6	25.6		17.2	16.4	16.4
65.0				37.8	37.8				36.6	36.6	36.8		30.8	30.8	31.0		25.8	25.4	25.4		17.2	16.4	16.4
70.0				33.6					32.8	32.8	33.0		28.6	28.6	28.6		24.2	24.2	24.2		17.2	16.4	16.4
75.0									29.4	29.4	29.4		26.4	26.4	26.6		22.6	22.6	22.6		17.2	16.4	16.4
80.0									26.0	26.0			24.6	24.6	24.8		21.0	21.0	21.0		17.2	16.4	16.4
85.0									23.2	23.2			22.8	22.8	23.0		19.6	19.6	19.6		16.4	16.4	16.4
90.0									20.8	20.8			20.6	20.6	20.8		18.2	18.2	18.4		15.4	15.4	15.4
95.0									18.8	18.8			19.2	19.2			17.0	17.0	17.2		14.2	14.2	14.2
100.0													18.4	18.4			15.8	15.8	15.8		13.4	13.4	13.4
105.0													17.4	17.4			14.4	14.4	14.4		12.8	12.8	12.8
110.0													16.0	16.0			13.0	13.0	13.2		12.2	12.2	12.2
115.0													14.6	14.6			12.2	12.2	12.2		11.6	11.6	11.6
120.0													13.2	13.2			11.0	11.0			11.0	11.0	11.0
125.0													12.0				9.8	9.8			10.4	10.4	10.4
130.0													11.0				8.8	8.8			9.8	9.8	9.8
135.0																	8.2	8.2			9.0	9.0	9.0
140.0																	7.8	7.8			8.2	8.2	
145.0																	7.4	7.4			7.2	7.2	
150.0																	7.0	7.0			6.4	6.4	
155.0																	6.6				5.8	5.8	
160.0																					5.0	5.0	
165.0																					4.4	4.4	
170.0																					3.8	3.8	
175.0																					3.4	3.4	
180.0																					2.8		

Loads for luffing







12,9 m - 60,0 m (42.3 - 196.9 ft)
 3,6 m (11.8 ft)
 40 100 kg (88,400 lb)
 25.6 ft x 24.6 ft spread 100%
 360°

Feet	42.3' + 11.8'		73.8' + 11.8'		104.5' + 11.8'		135.3' + 11.8'		166.4' + 11.8'		196.9' + 11.8'	
	0°-20°		20°-40°		0°-20°		20°-40°		0°-20°		20°-40°	
	0°-20°	20°-40°	0°-20°	20°-40°	0°-20°	20°-40°	0°-20°	20°-40°	0°-20°	20°-40°	0°-20°	20°-40°
10.0	67.0	67.0										
15.0	64.0	64.0		67.0								
20.0	62.0	62.0	66.0	66.0			60.0					
25.0	58.0	60.0	64.0	64.0			60.0			39.4		
30.0	55.0		63.0	63.0		63.0	60.0			39.4		24.4
35.0	53.0		62.0	62.0		63.0	60.0			39.4		24.4
40.0			59.0	61.0		61.0	60.0		39.4	39.4		24.4
45.0			57.0	60.0		56.0	56.0		39.4	39.4		24.4
50.0			53.0	53.0		52.0	52.0		38.0	38.0		24.4
55.0			45.0			45.0	45.0		35.2	35.2		24.4
60.0			39.4			39.0	39.2		32.4	32.4		24.4
65.0			34.4			34.2	34.2		29.4	29.4		24.2
70.0						30.0	30.2		27.2	27.2		23.0
75.0						26.6	26.8		25.2	25.4		21.4
80.0						23.8			23.4	23.6		20.0
85.0						21.2			21.2	21.4		18.6
90.0						19.0			19.2	19.4		17.4
95.0						17.0			18.2			16.2
100.0									17.4			15.0
105.0									15.8			13.8
110.0									14.4			12.4
115.0									13.2			11.2
120.0									12.0			10.0
125.0												9.0
130.0												8.2
135.0												7.8
140.0												7.4
145.0												7.0
150.0												6.6
155.0												5.2
160.0												4.6
165.0												4.0
170.0												3.6
175.0												3.0

THIS CHART IS ONLY A GUIDE AND SHOULD NOT BE USED TO OPERATE THE CRANE.

Load charts

Integrated heavy duty jib

Intermediate angle



12,9 m - 60,0 m
(42.3 - 196.9 ft)



3,6 m
(11.8 ft)



46 200 kg
(21,000 lb)



25.6 ft x 24.6 ft spread
100%



360°



Pounds x 1000

Feet	42.3' + 11.8'			73.8' + 11.8'			104.5' + 11.8'			135.3' + 11.8'			166.4' + 11.8'			196.9' + 11.8'		
	0°	<20°	<40°	0°	<20°	<40°	0°	<20°	<40°	0°	<20°	<40°	0°	<20°	<40°	0°	<20°	<40°
10.0	95.0	95.0	88.0															
15.0	91.0	87.0	85.0			88.0												
20.0	79.0	78.0	78.0	95.0	93.0	88.0			63.0									
25.0	70.0	70.0	71.0	91.0	87.0	85.0			63.0									
30.0	63.0	63.0		76.0	76.0	77.0	68.0	66.0	63.0			41.4						25.6
35.0	59.0	59.0		62.0	62.0	63.0	56.0	56.0	57.0			41.4						25.6
40.0	55.0			51.0	51.0	52.0	47.0	47.0	47.0			41.4						25.6
45.0				43.4	43.4	43.8	39.4	39.4	39.8	36.6	36.6	37.2	27.4	25.6	25.6			16.4
50.0				37.0	37.0	37.4	33.6	33.6	34.0	32.6	32.6	32.6	27.4	25.6	25.6			16.4
55.0				32.0	32.0		29.0	29.0	29.4	30.0	30.0	30.0	25.6	25.6	25.6			16.4
60.0				29.8	29.8		25.2	25.2	25.4	26.4	26.4	26.6	22.2	22.2	22.6			16.4
65.0				27.0	27.0		22.0	22.0	22.2	23.2	23.2	23.6	19.4	19.4	19.6			16.4
70.0				23.8			19.2	19.2	19.4	20.6	20.6	20.8	18.2	18.2	18.2			16.4
75.0							16.8	16.8	17.0	18.4	18.4	18.6	16.6	16.6	17.0			15.6
80.0							14.6	14.6		16.4	16.4	16.6	15.0	15.0	15.8			13.8
85.0							12.6	12.6		14.6	14.6	14.8	14.0	14.0	14.2			12.2
90.0							11.2	11.2		13.0	13.0	13.2	13.2	13.2	13.4			10.6
95.0							10.6	10.6		11.6	11.6		12.0	12.0	12.0			9.4
100.0										10.4	10.4		10.6	10.6	10.8			8.2
105.0										9.0	9.0		9.6	9.6	9.6			7.2
110.0										8.0	8.0		8.6	8.6	8.6			6.2
115.0										6.8	6.8		7.6	7.6	7.8			5.2
120.0										6.0	6.0		6.8	6.8				4.4
125.0										5.2			6.0	6.0				3.8
130.0										4.4			5.2	5.2				3.0
135.0													4.4	4.4				2.4
140.0													3.8	3.8				
145.0													3.2	3.2				
150.0													2.6	2.6				
155.0													2.0					

Loads for luffing



12,9 m - 60,0 m
(42.3 - 196.9 ft)



3,6 m
(11.8 ft)



46 200 kg
(21,000 lb)



25.6 ft x 24.6 ft spread
100%



360°



Pounds x 1000

Feet	42.3' + 11.8'		73.8' + 11.8'		104.5' + 11.8'		135.3' + 11.8'		166.4' + 11.8'		196.9' + 11.8'	
	0°-20°	20°-40°	0°-20°	20°-40°	0°-20°	20°-40°	0°-20°	20°-40°	0°-20°	20°-40°	0°-20°	20°-40°
10.0	67.0	67.0										
15.0	64.0	64.0		67.0								
20.0	62.0	62.0	66.0	66.0		60.0						
25.0	58.0	60.0	64.0	64.0		60.0		39.4				
30.0	55.0		63.0	63.0	63.0	60.0		39.4		24.4		
35.0	53.0		62.0	62.0	56.0	57.0		39.4		24.4		
40.0			51.0	51.0	47.0	47.0	39.4	39.4		24.4		15.6
45.0			41.6	42.0	39.4	39.8	36.6	37.2	24.4	24.4		15.6
50.0			34.6	34.8	33.6	34.0	31.4	31.8	24.4	24.4		15.6
55.0			30.4		28.8	29.2	28.6	28.6	24.4	24.4	15.6	15.6
60.0			28.2		24.4	24.6	26.4	26.6	22.2	22.6	15.6	15.6
65.0			24.6		21.0	21.0	23.2	23.6	19.4	19.6	15.6	15.6
70.0					18.0	18.0	20.4	20.6	17.2	17.2	15.6	15.6
75.0					15.4	15.6	17.8	18.0	15.8	16.2	15.4	15.6
80.0					13.4		15.6	15.8	14.2	15.0	13.6	13.8
85.0					11.4		13.8	13.8	13.4	13.6	12.0	12.2
90.0					10.6		12.2	12.2	12.6	12.8	10.6	10.6
95.0					10.0		10.6		11.6	11.6	9.2	9.4
100.0							9.4		10.2	10.4	8.0	8.2
105.0							8.2		9.0	9.2	7.0	7.2
110.0							7.2		8.0	8.0	6.0	6.2
115.0							6.2		7.0	7.2	5.4	5.2
120.0							5.4		6.2		4.4	4.4
125.0									5.4		3.6	3.8
130.0									4.8		3.0	3.0
135.0									4.0		2.4	2.4
140.0									3.4			
145.0									2.8			
150.0									2.4			

THIS CHART IS ONLY A GUIDE AND SHOULD NOT BE USED TO OPERATE THE CRANE.

The individual crane's load chart, operating instructions and other instructional plates must be read and understood prior to operating the crane.

Courtesy of Crane.Market

Symbols glossary



Axles



Counterweight



Grade



Gear



Boom



Drive



Heavy duty jib



Radius



Boom elevation



Electrical system



Hoist



Rotation



Boom extension



Engine



Hookblock



Speed



Boom length



Extension



Hydraulic system



Steering



Boom nose



Frame



Lights



Suspension



Brakes



Fuel tank capacity



Oil



Swing



Cab



Outriggers



Outrigger controls



Tires



Transmission

Manitowoc Cranes

Regional headquarters

Americas

Manitowoc, Wisconsin, USA

Tel: +1 920 684 6621

Fax: +1 920 683 6277

Shady Grove, Pennsylvania, USA

Tel: +1 717 597 8121

Fax: +1 717 597 4062

Europe, Middle East, Africa

Dardilly, France

Tel: +33 (0)4 72 18 20 20

Fax: +33 (0)4 72 18 20 00

China

Shanghai, China

Tel: +86 21 6457 0066

Fax: +86 21 6457 4955

Greater Asia-Pacific

Singapore

Tel: +65 6264 1188

Fax: +65 6862 4040

Regional offices

Americas

Brazil

Alphaville

Mexico

Monterrey

Chile

Santiago

Europe, Middle East,

Africa

France

Dardilly

Saint Pierre de Chandieu

Germany

Langenfeld

Italy

Lainate

Netherlands

Breda

Poland

Warsaw

Portugal

Baltar

Russia

Moscow

South Africa

Johannesburg

U.A.E.

Dubai

U.K.

Buckingham

China

Beijing

Chengdu

Guangzhou

Xian

Greater Asia-Pacific

Australia

Brisbane

Sydney

India

Ahmedabad

Bengaluru

Chennai

Gurgaon

Hyderabad

Kolkata

Mumbai

Noida

Pune

Korea

Seoul

Philippines

Makati City

Singapore

Factories

Brazil

Passo Fundo

China

Zhangjiagang

France

Charlieu

Moulins

Germany

Wilhelmshaven

India

Pune

Italy

Niella Tanaro

Portugal

Baltar

Fânzeres

USA

Manitowoc

Port Washington

Shady Grove

This document is non-contractual. Constant improvement and engineering progress make it necessary that we reserve the right to make specification, equipment, and price changes without notice. Illustrations shown may include optional equipment and accessories and may not include all standard equipment.