

GROVE®

GMK6350



ALL TERRAIN HYDRAULIC CRANE

Dimensions

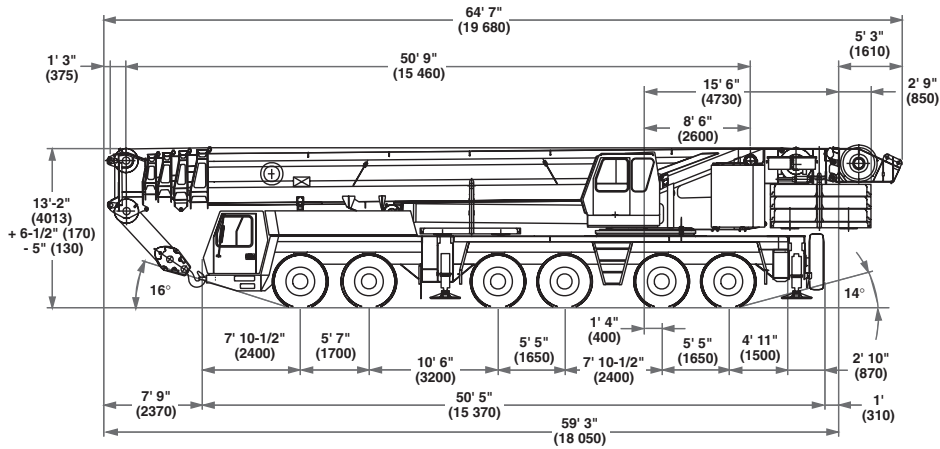
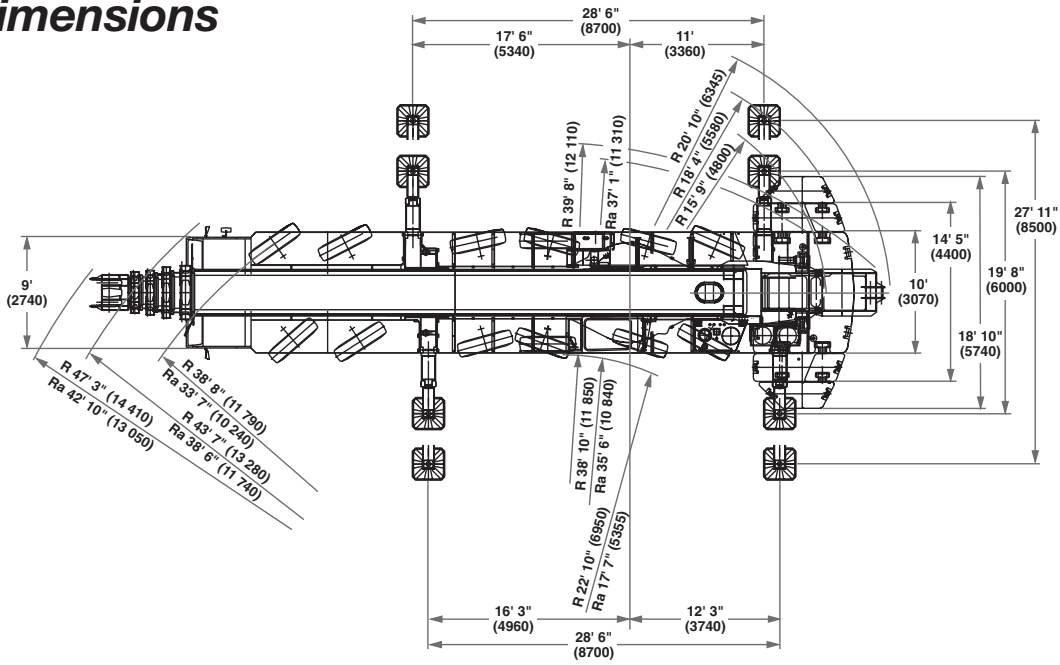

Note: () Reference dimensions in mm

BASIC WEIGHTS (LBS.)	Axles 1 & 2	Axles 3 - 6	Total
With Cummins Power, 12x6, 20.5 R25 Tires, 2nd Hydraulic Oil Cooler, Brackets for swingaway	51,347	108,241	159,588
Mercedes Power	-(361)	-(344)	-(705)
Additions:			
12 x 8 x 12 in lieu	965	-(105)	860
Outrigger Pads	-	772	772
Removable rear outrigger box option (Cummins eng)	-(1,225)	3,430	2,205
Auxiliary Hoist	-(5,365)	11,450	6,085
Swingaway	6,860	-(1,525)	5,335
Spare Wheel 20.5 with stowage	-(590)	1,400	810
Spare Wheel 16.00 with stowage	-(520)	1,240	720
Spare Wheel 14.00 with stowage	-(425)	1,010	585
Fixed MEGALIFT brackets w/o winch	653 lbs.	-123 lbs.	530 lbs.
Fixed bracket for MEGALIFT winch	119 lbs.	212 lbs.	331 lbs.
Bolted parts for MEGALIFT	119 lbs.	212 lbs.	331 lbs.
MEGALIFT winch	6,257 lbs.	5,736 lbs.	11,993 lbs.
Removal:			
Front Outrigger Beams & Jacks	-(3,380)	-(1,980)	-(5,360)
Rear Outrigger Beams & Jacks	3,730	-(9,650)	-(5,920)
Outrigger Box (must add weight above for option)	6,750	-(17,550)	-(10,800)
Boom Assembly (minus lift cylinder)	-(34,750)	-(23,175)	-(57,925)
Telescope Sections 1-4	-(27,900)	-(15,860)	-(43,760)
Lift Cylinder	-(2,250)	-(3,400)	-(5,650)
16.00 R25 Tires in lieu	-(370)	-(740)	-(1,110)
14.00 R25 Tires in lieu	-(900)	-(1,800)	-(2,700)

THIS CHART IS ONLY A GUIDE AND SHOULD NOT BE USED TO OPERATE THE CRANE.
The individual crane's load chart, operating instructions and other instructional plates must be read and understood prior to operating the crane.

TRAILING BOOM WEIGHTS

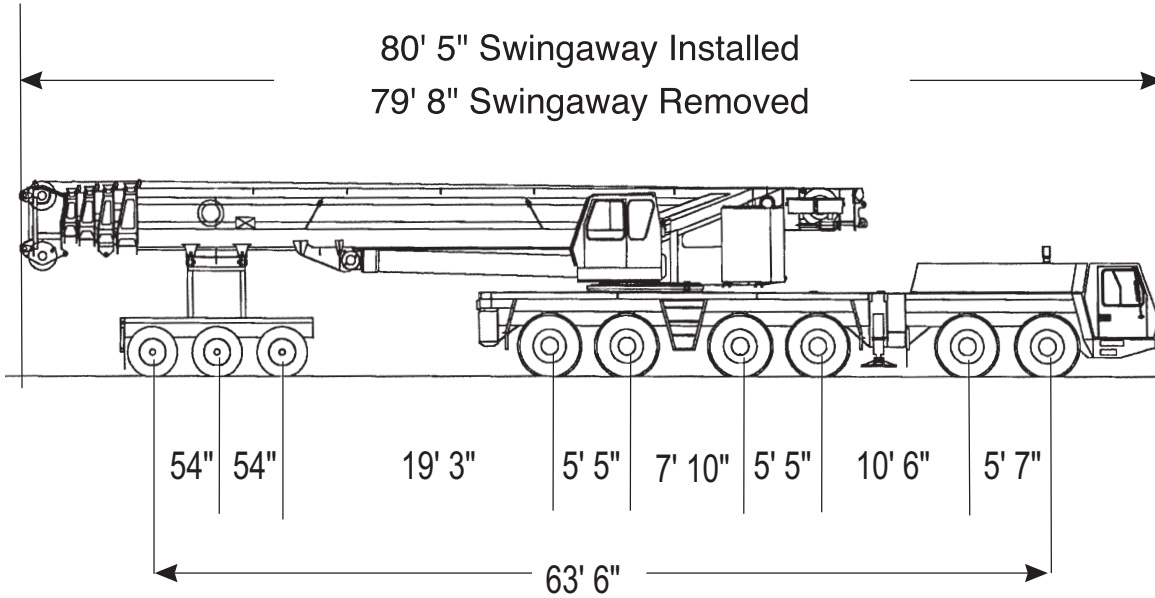

DOLLY

56,167 LBS.

REAR 4 AXLES

90,267 LBS.

FRONT 2 AXLES

34,781 LBS.

G.V.W.: 181,215 LBS.

UNIT EQUIPPED AS FOLLOWS:

Cummins engines carrier and superstructure, outrigger pads in place, frame equipped for removable outrigger box, rear box in place, main & auxiliary hoist with rope, swingaway on boom, 3 axle boom dolly (7,600 LBS.), 20.5 tires, counterweight removed. 12 x 6 x 12 drive.

Weight effects:

Component	Dolly	Rear Axles	Front Axles	Gross
Remove rear outrigger box	0	-17,555 lbs.	+6,753 lbs.	-10,802 lbs.
Remove front outrigger beams	0	-1,980 lbs.	-3,377 lbs.	-5,357 lbs.
Remove rear outrigger beams	0	-9,562 lbs.	+3,753 lbs.	-5,580 lbs.
Remove auxiliary hoist with rope	0	-2,134 lbs.	-3,951 lbs.	-6,085 lbs.
Remove swingaway	-5,952 lbs.	+456 lbs.	+161 lbs.	-5,335 lbs.
Mercedes engines ILO Cummins	0	-317 lbs.	-388 lbs.	-705 lbs.
Add 12 x 8 x 12 Drive	0	-106 lbs.	+966 lbs.	+806 lbs.
Fixed MEGALIFT brackets w/o winch	582 lbs.	-40 lbs.	-13 lbs.	529 lbs.
Fixed bracket for MEGALIFT winch	181 lbs.	110 lbs.	40 lbs.	331 lbs.
Bolted parts for MEGALIFT	181 lbs.	110 lbs.	40 lbs.	331 lbs.
MEGALIFT winch	7,773 lbs.	3,119 lbs.	1,101 lbs.	11,993 lbs.

Note: Weights may vary 3% due to manufacturing tolerances.

THIS CHART IS ONLY A GUIDE AND SHOULD NOT BE USED TO OPERATE THE CRANE.
The individual crane's load chart, operating instructions and other instructional plates must be read and understood prior to operating the crane.

Superstructure specifications

Boom

51 ft. - 197 ft. (15.5 m - 60 m) five section, full power MEGAFORM™ boom with patented TWIN-LOCK™ boom pinning system. Maximum tip height: 207 ft. (63 m).

Boom Elevation

Single lift cylinder with safety valve provides boom angle from -1.5° to +82°.

* Telescopic Swingaway Extension

36 ft. - 62 ft. (11 m - 19 m) telescoping offsettable swingaway extension. Offsettable at 5° and 30°.

Lattice Jib

Luffing Jib is a lattice design with lengths of 69 ft. - 200 ft. (21 m - 61m) in sections of 26 ft. (8 m). The luffing jib converts to a fixed offset lattice jib using an offset angle adapter and provides lengths of 62 ft. - 194 ft. (19 m - 59 m) offsettable at 3° and 25°.

MEGALIFT™ Attachment-Main Boom

Consists of a mast, pendant lines, and hydraulic tensioning winch to support the main boom during lifting operations. Load charts available for main boom only as optional equipment.

Load Moment & Anti-Two Block System

Load moment and anti-two block system with audio/visual warning and control lever lockout provides electronic display of boom angle, length, radius, tip height, relative load moment, maximum permissible load, load indication and warning of impending two-block condition.

Cab

All aluminum construction cab is tiltable (approximately 20°) and includes safety glass and adjustable operator's seat with hydraulic suspension. Other features include engine dependent hot water heater, armrest integrated crane controls, and ergonomically arranged instrumentation.

Swing

3 axial piston fixed displacement motors provide swing speed of 0 - 1.6 RPM thru planetary gear box. Also provided is a spring applied, hydraulically released automatic swing brake with foot operated release for free swing.

Counterweight

220,400 lbs. (100 Tonnes) consisting of various sections with hydraulic installation/removal system (see counterweight configuration on page 17).

Engine

Cummins 6CTA8.3-C, diesel, 6 cylinders, water cooled, turbocharged, 260 HP (194 kW) at 1800 rpm. Max. torque: 826 ft./lbs. (1120 Nm) at 1700 rpm. Engine emission: EUROMOT/EPA/CARB (off highway).

Fuel Tank Capacity

87 gal. (330 L).

Hydraulic system

4 separate circuits, 3 axial piston variable displacement pumps with electronic power limiting control and 1 axial piston variable displacement pump for slewing. Standard thermostatically controlled oil cooler keeps oil at optimum operating temperature.

Tank capacity: 322 gal. (1220 L)

Control system

Full electronic control of all crane movements is accomplished using electrical control levers with automatic reset to zero. Controls are integrated with the LMI and engine management system by CAN-BUS.

Hoist

Main and auxiliary hoist are powered by axial piston variable displacement motor with planetary gear and brake. "Thumb-thumper" hoist drum rotation indicator alerts operator of hoist movement.

	Main	Auxiliary
Line length:	984 ft. (300 m)	1,378 ft. (420 m)
Rope diameter:	24 mm	24 mm
Line speed:	460 ft./min.	426 ft./min.
Line pull:	24,700 lbs. (110 kN)	24,700 lbs. (110 kN)

Electrical system

24 V system with three-phase alternator 28 V/80 A, 2 batteries 12 V/170 Ah.

* Optional equipment

- * Engine-independent hot water heater, with engine pre-heater
- * Second spotlight
- * Stereo/cassette player
- * Air Conditioning
- * Mercedes-Benz engine
- * MEGALIFT attachment

* Denotes optional equipment

Carrier specifications

Chassis

Box-type, torsion resistant frame is fabricated from high-strength steel.

Outrigger System

Hydraulic two-stage outrigger beams are extended by a single hydraulic cylinder and two cables. Outriggers can adjust to two positions:

Fully extended (100%) - 27' 11" (8.5 m)

Partially extended (50%) - 19' 8" (6 m)

Four 29.5 in. x 32 in. (750 mm x 810 mm), self stowing, steel outrigger pads provide rigid lifting base. Outrigger controls are located on both sides of the carrier. An electronic level indicator is located next to each outrigger control box.

Engine

Cummins N14-525 E+, diesel, 6 cylinders, water-cooled, turbocharged, 525 HP (392 kW) at 2100 rpm. Max. torque: 1850 ft. lbs. (2509 Nm) at 1200 rpm. Engine emission: EPA/CARB (on highway).

Fuel Tank capacity

132 gal. (500 L).

Transmission

Allison automatic CLT 755, 5 forward and 1 reverse speed. Transfer case with 2 speeds and inter-axle differential lock.

Drive/Steer

12 x 6 x 12.

Axles

6 axles. 1, 2, 4 and 5 are drive/steer. Axles 3 and 6 are steer only.

Suspension

GROVE GMK6350 features the Grove exclusive MEGATRAK† suspension. This revolutionary design features an independent hydroneumatic system with hydraulic lockout acting on all wheels. The suspension can be raised 6-1/2" (170 mm) or lowered 5" (130 mm) both longitudinally and transversely and features an automatic leveling system for on-highway travel.

Tires

12 tires, 20.5 R25.

Steering

Dual circuit steering system is hydraulic power assisted with a transfer case mounted, ground driven, emergency steering pump. Axles 1, 2, 3, 5 and 6 steer on highway. Separate steering of the 4th, 5th and 6th axle for all wheel steer and crab-steer is controlled by an electric rocker switch.

Brakes

A dual circuit air system operates on all wheels with a spring-applied, air released parking brake acting on axles 2, 4, 5 and 6. An air dryer is fitted to remove moisture from the air system.

Engine compression brake is standard.

Cab

Two-man, aluminum construction driver's cab includes the following features: safety glass; driver and passenger seats with hydraulic suspension, engine-dependent hot water heater, complete instrumentation and driving controls.

Electrical system

24 V system with three-phase alternator 28 V/80 A, 2 batteries 12 V/170 Ah.

Maximum Speed

48 mph (77km/h) with 20.5 R25 tires.

Gradeability (theoretical)

46% with 20.5 R25 tires.

Miscellaneous standard equipment

Boom removal kit; trailing boom kit (less dolly); additional hydraulic oil cooler; removable rear outrigger box (Cummins engine version); spare tire and wheel - 20.5 R25 with carry bracket; flashing amber warning light on carrier cab; working light; tool kit; fire extinguisher; radio cassette in carrier cab.

* Optional equipment

- * 12 x 8 x 12
- * Electric driveline retarder
- * 16.00 R25 tires (vehicle width 9 ft. 10 in. [3 m])
- * Outrigger pressure measurement devices
- * Engine-independent hot water heater, with engine pre-heater
- * Third seat
- * Trailing boom "boost" weight transfer kit
- * Air conditioning
- * Mercedes-Benz engine (removable outrigger box not supplied)

* Denotes optional equipment

† "G MEGATRAK" (and design) is a trademark of Grove U.S. L.L.C.

Working range



51 - 197 ft.
(15.5 - 60 m)



36 - 62 ft.
(11 - 19 m)



220,400 lbs
(100 tonnes)



100%



360°

FEET

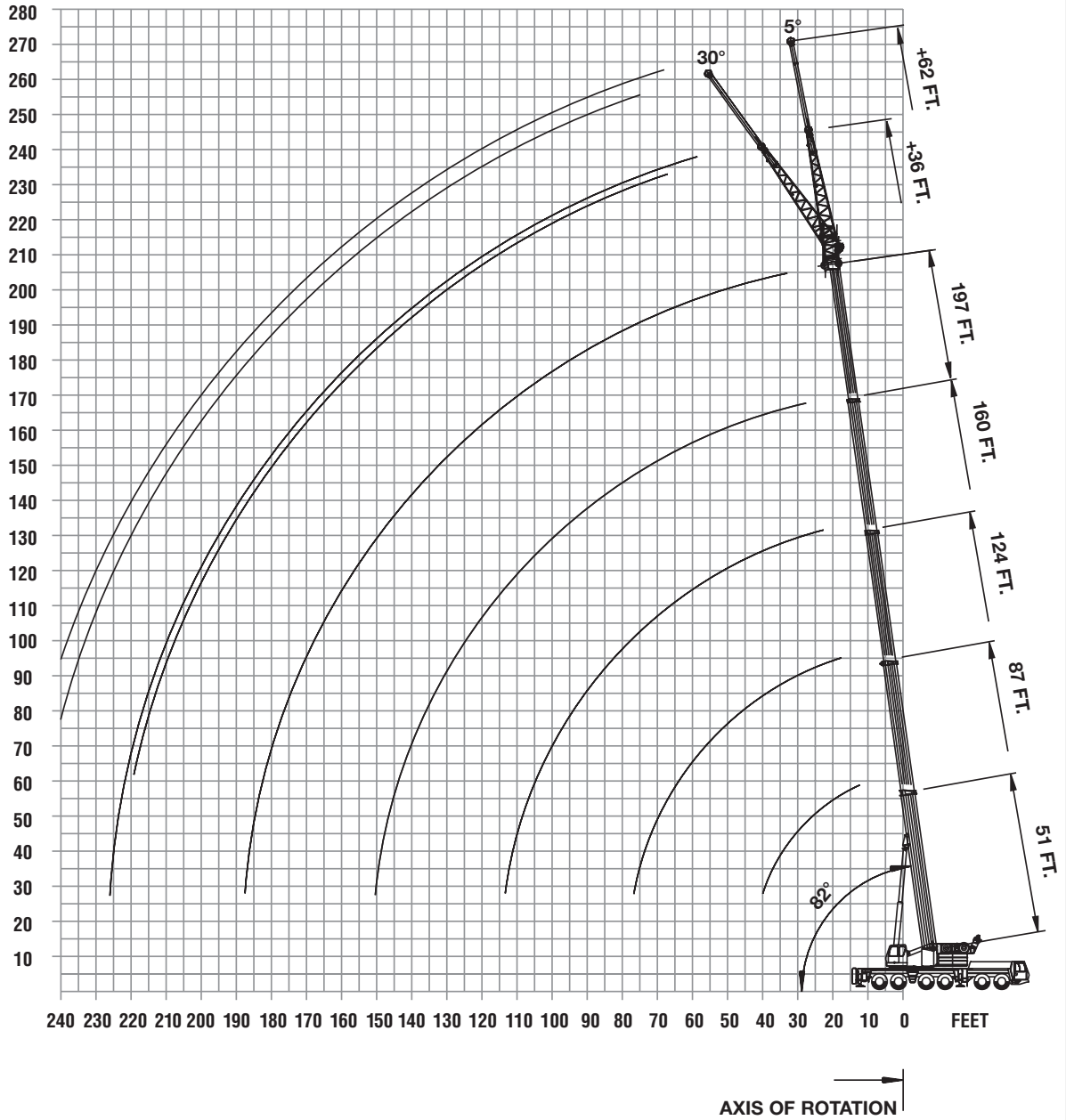

THIS CHART IS ONLY A GUIDE AND SHOULD NOT BE USED TO OPERATE THE CRANE.
The individual crane's load chart, operating instructions and other instructional plates must be read and understood prior to operating the crane.





51 - 197 ft.
 (15.5 - 60.0 m)

220,400 lbs.
 (100 Tonnes)

100%
 27'11" Spread

360°

Feet	Pounds (thousands)									
	51*	51	69	87	106	124	142	160	178	197
8	700.0†									
10	542.0									
15	412.0	466.0	422.0	342.0						
20	332.0	370.0	366.0	342.0	242.0					
25	266.0	302.0	302.0	300.0	242.0	185.0	139.0			
30	219.0	254.0	258.0	254.0	242.0	185.0	139.0	106.0		
35	185.0	218.0	222.0	222.0	220.0	185.0	139.0	106.0	78.0	66.0
40		185.0	188.0	188.0	187.0	174.0	137.0	106.0	78.0	66.0
45			162.0	163.0	161.0	161.0	126.0	106.0	78.0	66.0
50			142.0	143.0	141.0	144.0	116.0	102.0	78.0	66.0
55			126.0	126.0	128.0	128.0	106.0	95.0	78.0	66.0
60			113.0	113.0	116.0	114.0	98.0	88.0	78.0	66.0
65				102.0	105.0	103.0	91.0	82.0	75.0	66.0
70				92.0	95.0	93.0	84.0	76.0	70.0	65.0
75				85.0	86.0	85.0	78.0	71.0	66.0	62.0
80					79.0	77.0	73.0	66.0	62.0	59.0
85					72.0	70.0	67.0	62.0	58.0	56.0
90					67.0	65.0	64.0	58.0	54.0	52.0
95					62.0	60.0	61.0	54.0	50.0	49.0
100						55.0	57.0	50.0	47.0	46.0
105						51.0	53.0	48.0	45.0	43.4
110						47.0	50.0	45.0	42.4	41.0
115						45.0	46.0	42.4	40.2	39.0
120							43.2	40.4	38.2	37.0
125							40.6	38.6	36.2	35.2
130								37.0	34.4	33.6
135								34.6	32.6	32.0
140								33.4	31.2	30.0
145								32.4	30.0	27.8
150									28.8	26.0
155									27.2	24.8
160									25.6	23.8
165									24.4	22.6
170										21.8
175										20.6
180										19.2
										17.2

* Over rear only, 28'6" x 19'8" outrigger base.
 Lifting capacities greater than 425,000 lbs require additional equipment.
 † 700,00 lbs is a comparative rating



51 - 197 ft.
 (15.5 - 60.0 m)

110,200 lbs.
 (50 Tonnes)

100%
 27'11" Spread

360°



Feet	Pounds (thousands)									
	51	69	87	106	124	142	160	178	197	
10	446.0	422.0	342.0							
15	352.0	352.0	342.0	242.0						
20	278.0	282.0	282.0	242.0	185.0	139.0				
25	222.0	224.0	224.0	224.0	185.0	139.0	106.0			
30	180.0	183.0	183.0	182.0	182.0	139.0	106.0	78.0	66.0	
35	147.0	150.0	151.0	155.0	150.0	137.0	106.0	78.0	66.0	66.0
40		129.0	131.0	130.0	126.0	118.0	106.0	78.0	66.0	66.0
45		111.0	113.0	112.0	108.0	102.0	97.0	78.0	66.0	66.0
50		95.0	97.0	97.0	94.0	94.0	87.0	78.0	66.0	66.0
55		81.0	83.0	83.0	82.0	83.0	79.0	73.0	66.0	66.0
60			73.0	72.0	75.0	73.0	70.0	68.0	66.0	66.0
65			64.0	63.0	66.0	64.0	64.0	63.0	59.0	59.0
70			57.0	59.0	59.0	57.0	58.0	56.0	53.0	53.0
75				54.0	53.0	52.0	52.0	51.0	48.0	48.0
80				48.0	48.0	48.0	47.0	46.0	43.0	43.0
85				43.8	42.8	43.6	42.6	41.2	39.0	39.0
90				39.6	38.8	39.6	38.4	37.0	35.4	35.4
95					36.2	36.0	34.8	33.4	31.8	31.8
100					33.0	32.8	31.6	30.2	28.6	28.6
105					30.0	29.8	28.8	27.4	25.6	25.6
110					27.6	27.4	26.2	24.8	23.2	23.2
115						25.0	23.8	22.6	20.8	20.8
120							23.0	21.8	20.4	18.8
125								19.8	18.6	16.8
130								18.2	16.8	15.0
135								16.6	15.2	13.4
140								15.0	13.8	12.0
145									12.4	10.6
150									11.2	9.4
155									10.0	8.2
160									9.0	7.0
165										6.0
170										5.0
175										4.2

Lifting capacities greater than 425,000 lbs require additional equipment.
 Note: Above chart is available with reduced outriggers.

THIS CHART IS ONLY A GUIDE AND SHOULD NOT BE USED TO OPERATE THE CRANE.
 The individual crane's load chart, operating instructions and other instructional plates must be read and understood prior to operating the crane.

 179-197 ft. (54.4-60.0 m)
  36-62 ft. (11-19 m)
  220,400 lbs. (100 Tonnes)
  100% 27'11" Spread
  360°

Pounds (thousands)												
Feet	179 FT MAIN BOOM					197 FT MAIN BOOM						
	5°	36 FT		5°	62 FT	30°	5°	36 FT		5°	62 FT	30°
40	45.0			19.0			38.8			18.4		
45	43.6			18.4			38.8			18.2		
50	42.8		32.6	17.6			38.8		30.8	17.6		
55	42.0		31.8	17.0			38.4		30.4	17.0		
60	41.2		31.0	16.2			37.8		30.2	16.2		
65	40.4		30.4	15.6			37.4		29.8	15.8		
70	39.6		29.8	15.0		10.0	36.8		29.6	15.2		
75	39.0		29.2	14.4		9.8	36.4		29.2	14.6		9.8
80	38.2		28.6	14.0		9.6	35.8		28.6	14.2		9.6
85	37.6		28.0	13.6		9.4	35.4		28.2	13.8		9.4
90	36.8		27.6	13.0		9.2	34.4		27.6	13.2		9.4
95	36.0		26.8	12.6		9.2	34.0		27.0	13.0		9.2
100	35.2		25.8	12.2		9.0	34.0		26.0	12.6		9.0
105	34.4		24.8	11.8		8.8	33.6		25.0	12.2		8.8
110	33.4		24.6	11.6		8.6	33.0		24.6	11.8		8.8
115	32.6		24.2	11.2		8.6	32.6		24.4	11.6		8.6
120	31.6		23.8	11.0		8.4	32.0		24.0	11.2		8.6
125	30.8		23.6	10.6		8.4	31.0		23.8	11.0		8.4
130	30.0		23.4	10.4		8.2	30.2		23.6	10.6		8.4
135	28.6		23.2	10.2		8.2	28.6		23.4	10.4		8.2
140	27.2		23.0	10.0		8.0	26.8		23.0	10.2		8.2
145	25.8		22.8	9.6		8.0	25.2		22.8	10.0		8.0
150	24.6		22.6	9.4		7.8	24.2		22.8	9.8		8.0
155	23.6		22.4	9.2		7.8	23.0		22.6	9.6		7.8
160	22.4		22.2	9.0		7.8	22.2		22.2	9.4		7.8
165	21.0		21.6	8.8		7.6	21.2		21.6	9.2		7.8
170	20.2		20.4	8.8		7.6	20.2		20.8	9.0		7.6
175	19.4		19.8	8.6		7.6	19.0		20.0	8.8		7.6
180	18.8					7.6	17.8		18.6	8.6		7.6
185	18.2					7.4	16.6		17.2	8.6		7.6
190	17.4					7.4	15.4		16.0	8.4		7.6
195						7.4	14.2			8.2		7.4
200							13.2			8.2		7.4
205							12.4			8.0		7.4
210										8.0		7.4
215										7.8		7.4
220										7.8		7.4
225										7.6		
230										7.6		
235										7.4		
240										7.4		

 179-197 ft. (54.4-60.0 m)
  36-62 ft. (11-19 m)
  110,200 lbs. (50 Tonnes)
  100% 27'11" Spread
  360°

Pounds (thousands)												
Feet	179 FT MAIN BOOM					197 FT MAIN BOOM						
	5°	36 FT		5°	62 FT	30°	5°	36 FT		5°	62 FT	30°
40	45.0			19.0			38.8			18.4		
45	43.6			18.4			38.8			18.2		
50	42.8		32.6	17.6			38.8		30.8	17.6		
55	42.0		31.8	17.0			38.4		30.4	17.0		
60	41.2		31.0	16.2			37.8		30.2	16.2		
65	40.4		30.4	15.6			37.4		29.8	15.8		
70	39.6		29.8	15.0		10.0	36.8		29.6	15.2		
75	39.0		29.2	14.4		9.8	36.4		29.2	14.6		9.8
80	38.2		28.6	14.0		9.6	35.8		28.6	14.2		9.6
85	36.8		28.0	13.6		9.4	35.4		28.2	13.8		9.4
90	36.0		27.6	13.0		9.2	33.6		27.6	13.2		9.4
95	33.8		26.8	12.6		9.2	30.6		27.0	13.0		9.2
100	30.8		25.8	12.2		9.0	27.8		26.0	12.6		9.0
105	27.8		24.8	11.8		8.8	25.2		25.0	12.2		8.8
110	25.2		24.6	11.6		8.6	23.0		24.6	11.8		8.8
115	23.0		24.0	11.2		8.6	20.8		23.2	11.6		8.6
120	20.8		22.6	11.0		8.4	18.8		21.0	11.2		8.6
125	18.8		20.6	10.6		8.4	16.8		18.8	11.0		8.4
130	17.0		18.6	10.4		8.2	15.0		17.0	10.6		8.4
135	15.4		17.0	10.2		8.2	13.4		15.2	10.4		8.2
140	14.0		15.4	10.0		8.0	12.0		13.6	10.2		8.2
145	12.6		13.8	9.6		8.0	10.6		12.2	10.0		8.0
150	11.2		12.4	9.4		7.8	9.2		10.8	9.8		8.0
155	10.0		11.2	9.2		7.8	8.0		9.4	9.6		7.8
160	9.0		10.0	9.0		7.8	7.0		8.2	9.4		7.8
165	8.0		8.8	8.8		7.6	6.0		7.0	9.2		7.8
170	7.0		7.8	8.6		7.6	5.0		6.0	8.2		7.6
175	6.0		6.8	8.6		7.6	4.0		5.0	7.2		7.6
180	5.2			8.2		7.6	3.2		4.0	6.4		7.6
185	4.4			7.4		7.4			3.2	5.6		7.2
190	3.6			6.6		7.4				4.8		6.4
195				5.8		7.0				4.0		5.6
200				5.2		6.2				3.4		4.6
205				4.4						2.6		3.8
210				3.8								3.2
215				3.2								
220				2.6								

THIS CHART IS ONLY A GUIDE AND SHOULD NOT BE USED TO OPERATE THE CRANE.
The individual crane's load chart, operating instructions and other instructional plates must be read and understood prior to operating the crane.

Working range - MEGALIFT



142 - 197 ft.
(43.4 - 60 m)



220,400 lbs
(100 tonnes)



100%



360°

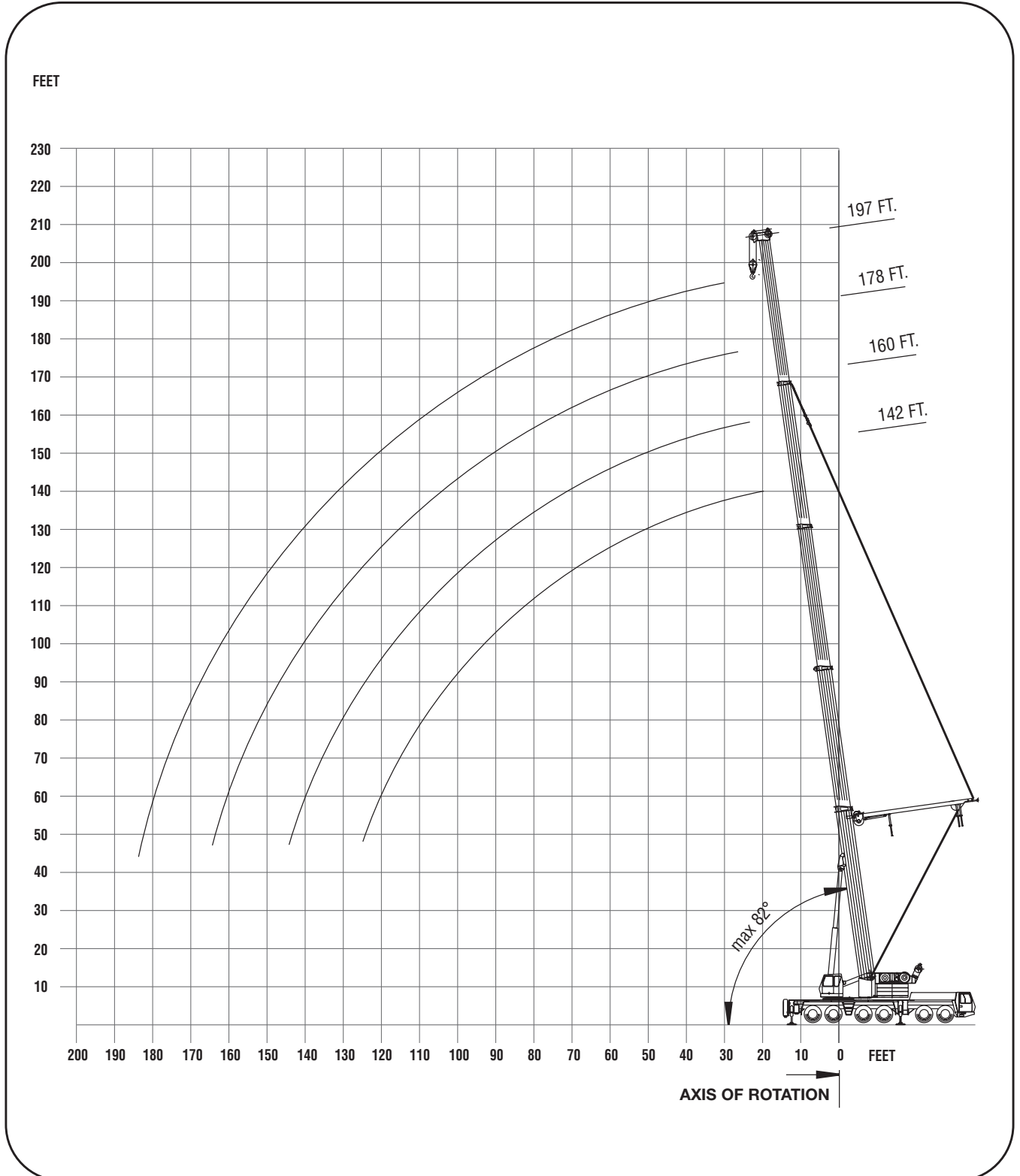

THIS CHART IS ONLY A GUIDE AND SHOULD NOT BE USED TO OPERATE THE CRANE.
The individual crane's load chart, operating instructions and other instructional plates must be read and understood prior to operating the crane.





51 - 197 ft.
 (15.5 - 60.0 m)

220,400 lbs.
 (100 Tonnes)

100%
 27'11" Spread

360°

		Pounds (thousands)			
Feet	142	160	178	197	
20	139.0				
25	139.0	106.0			
30	139.0	106.0	78.0	66.0	
35	139.0	106.0	78.0	66.0	
40	139.0	106.0	78.0	66.0	
45	139.0	106.0	78.0	66.0	
50	126.0	106.0	78.0	66.0	
55	112.0	106.0	78.0	66.0	
60	100.0	101.0	78.0	66.0	
65	91.0	91.0	78.0	66.0	
70	82.0	83.0	78.0	66.0	
75	75.0	77.0	76.0	66.0	
80	71.0	71.0	70.0	66.0	
85	66.0	66.0	64.0	65.0	
90	63.0	62.0	59.0	60.0	
95	59.0	58.0	56.0	56.0	
100	55.0	54.0	53.0	52.0	
105	51.0	50.0	49.0	48.0	
110	47.0	47.0	46.0	44.0	
115	44.0	43.4	42.6	41.2	
120	41.4	40.6	39.8	38.4	
125		38.0	37.0	35.8	
130		35.6	34.6	33.4	
135		33.4	32.4	31.0	
140		31.2	30.4	29.0	
145			28.4	27.0	
150			26.6	25.2	
155			25.0	23.6	
160			23.4	22.0	
165				20.6	
170				19.2	
175				17.8	
180				14.4	





51 - 197 ft.
 (15.5 - 60.0 m)

110,200 lbs.
 (50 Tonnes)

100%
 27'11" Spread

360°

		Pounds (thousands)			
Feet	142	160	178	197	
20	139.0				
25	139.0	106.0			
30	139.0	106.0	78.0	66.0	
35	139.0	106.0	78.0	66.0	
40	122.0	106.0	78.0	66.0	
45	105.0	101.0	78.0	66.0	
50	96.0	95.0	78.0	66.0	
55	89.0	85.0	76.0	66.0	
60	78.0	75.0	72.0	66.0	
65	69.0	67.0	64.0	60.0	
70	61.0	60.0	57.0	54.0	
75	54.0	54.0	52.0	48.0	
80	49.0	48.0	47.0	43.6	
85	43.6	42.8	41.8	39.4	
90	39.4	38.6	37.4	35.6	
95	35.4	34.6	33.6	32.0	
100	32.0	31.2	30.2	28.6	
105	29.0	28.2	27.2	25.6	
110	26.2	25.4	24.4	23.0	
115	23.8	23.0	22.0	20.4	
120	21.6	20.8	19.8	18.2	
125		18.8	17.8	16.2	
130		16.8	15.8	14.4	
135		15.2	14.2	12.6	
140		13.6	12.6	11.0	
145			11.2	9.6	
150			9.8	8.2	
155			8.6	7.0	
160			7.4	5.8	
165				4.8	
170				3.8	

THIS CHART IS ONLY A GUIDE AND SHOULD NOT BE USED TO OPERATE THE CRANE.
 The individual crane's load chart, operating instructions and other instructional plates must be read and understood prior to operating the crane.

Working range



51 - 197 ft.
(15.5 - 60 m)



62 - 167 ft.
(19 - 51 m)



220,400 lbs
(100 tonnes)



100%



360°

FEET

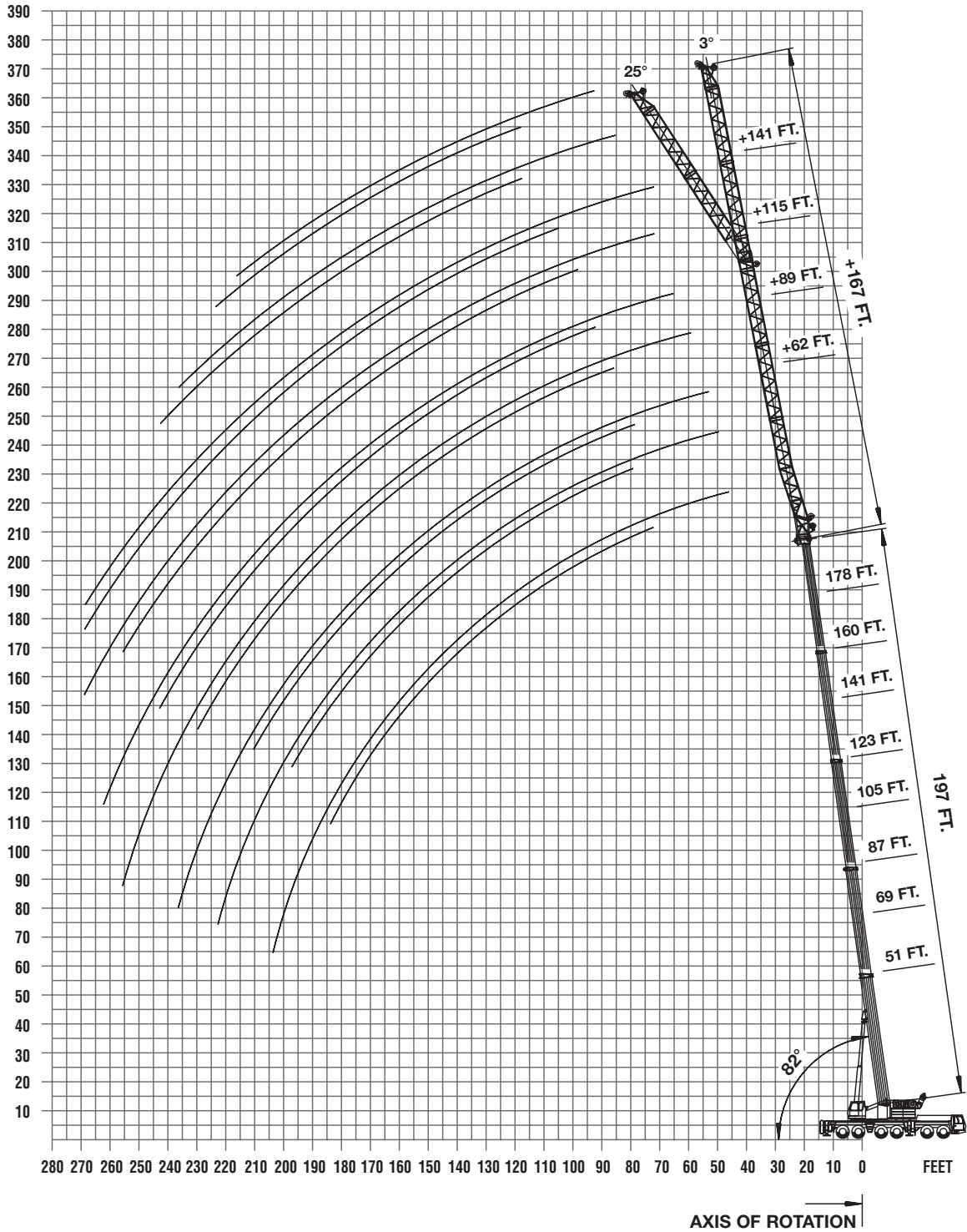

THIS CHART IS ONLY A GUIDE AND SHOULD NOT BE USED TO OPERATE THE CRANE.
The individual crane's load chart, operating instructions and other instructional plates must be read and understood prior to operating the crane.



		Pounds (thousands)									
Feet	62 FT		89 FT		115 FT		141 FT		167 FT		194 FT
	3°	25°	3°	25°	3°	25°	3°	25°	3°	25°	3°
35											
40											
45											
50	29.2										
55	29.2	28.6	21.2								
60	29.2	28.6	21.2		16.4						
65	29.2	28.6	21.2		16.4						
70	29.2	28.6	21.2		16.4		11.6				
75	29.2	28.6	21.2	20.6	16.4		11.6		9.2		
80	29.2	28.6	21.2	20.6	16.4		11.6		9.2		4.8
85	29.2	28.6	21.2	20.6	16.4		11.6		9.2		4.8
90	29.2	28.6	21.2	20.6	16.4		11.6		9.2		4.8
95	28.6	27.8	21.2	20.6	16.4	16.2	11.6		9.2		4.8
100	27.6	26.8	21.2	20.2	16.4	16.2	11.6		9.2		4.8
105	26.4	25.4	20.8	19.6	16.4	16.2	11.6	12.2	9.2		4.8
110	25.4	23.8	20.2	19.0	16.4	15.6	11.6	12.2	9.2		4.8
115	24.2	22.8	19.6	18.4	16.2	15.2	11.6	12.2	9.2	9.4	4.8
120	23.0	22.0	19.0	17.8	15.6	14.6	11.6	12.2	9.2	9.4	4.8
125	21.8	21.2	18.2	17.4	15.2	14.2	11.6	12.0	9.2	9.4	4.8
130	20.6	20.4	17.6	16.8	14.6	13.8	11.6	11.6	9.2	9.2	4.8
135	19.8	19.8	17.0	16.4	14.2	13.2	11.6	11.2	9.0	9.0	4.8
140	19.2	19.2	16.4	15.8	13.8	12.8	11.2	10.8	8.8	8.8	4.8
145	18.6	18.6	16.0	15.4	13.2	12.6	11.0	10.6	8.6	8.6	4.8
150	18.0	17.8	15.4	15.0	12.8	12.2	10.6	10.2	8.4	8.2	4.8
155	17.2	17.2	14.8	14.6	12.4	11.8	10.2	9.8	8.0	8.0	4.8
160	16.6	16.6	14.2	14.2	12.0	11.4	9.8	9.6	7.8	7.8	4.8
165	16.0	16.0	13.8	13.6	11.6	11.0	9.4	9.2	7.6	7.6	4.8
170	15.2	15.2	13.4	13.2	11.2	10.8	9.0	8.8	7.2	7.4	4.8
175	14.6	14.6	12.8	12.8	10.8	10.4	8.8	8.6	7.0	7.0	4.6
180	13.8	14.0	12.4	12.4	10.4	10.2	8.4	8.4	6.8	6.8	4.4
185	13.2	13.4	12.0	12.0	10.2	9.8	8.2	8.0	6.4	6.6	4.2
190	12.6	12.6	11.6	11.6	9.8	9.6	7.8	7.8	6.2	6.2	4.2
195	11.8	12.0	11.0	11.2	9.4	9.2	7.6	7.4	5.8	6.0	4.0
200	10.8	11.2	10.6	10.8	9.2	9.0	7.2	7.2	5.6	5.8	3.8
205	9.8	10.2	10.2	10.4	8.8	8.8	7.0	7.0	5.4	5.6	3.6
210	9.0	9.2	9.6	10.0	8.4	8.4	6.8	6.8	5.2	5.4	3.4
215	8.0	8.2	9.2	9.4	8.2	8.2	6.6	6.6	5.0	5.2	3.2
220	7.2	7.4	8.4	9.0	7.8	8.0	6.4	6.4	4.8	4.8	3.0
225	6.4		7.6	8.4	7.6	7.6	6.0	6.2	4.6	4.6	2.8
230	5.6		6.8	7.4	7.2	7.4	5.8	5.8	4.4	4.4	2.6
235	4.8		6.0	6.6	6.6	7.0	5.6	5.6	4.2	4.2	
240	3.8		5.2	5.8	6.0	6.8	5.4	5.4	4.0	4.2	
245			4.6	5.0	5.2	6.4	5.2	5.2	3.8	4.0	
250			4.0		4.6	5.6	4.8	5.0	3.6	3.8	
255			3.2		4.0	5.0	4.2	4.8	3.4	3.6	
260			2.6		3.4	4.2	3.6	4.6	3.2	3.4	
265					2.8	3.6	3.0	4.2	3.0	3.2	
270								3.6	2.6	3.0	
275								2.8		2.8	
280									2.6	2.6	



		Pounds (thousands)									
Feet	62 FT		89 FT		115 FT		141 FT		167 FT		
	3°	25°	3°	25°	3°	25°	3°	25°	3°	25°	
35											
40											
45											
50	29.2										
55	29.2	28.6	21.2								
60	29.2	28.6	21.2		16.4						
65	29.2	28.6	21.2		16.4						
70	29.2	28.6	21.2		16.4		11.6				
75	29.2	28.6	21.2	20.6	16.4		11.6		9.2		
80	29.2	28.6	21.2	20.6	16.4		11.6		9.2		
85	29.2	28.6	21.2	20.6	16.4		11.6		9.2		
90	29.2	28.6	21.2	20.6	16.4		11.6		9.2		
95	27.8	27.8	21.2	20.6	16.4	16.2	11.6		9.2		
100	25.0	26.4	21.2	20.2	16.4	16.2	11.6		9.2		
105	22.6	23.8	20.8	19.6	16.4	16.2	11.6	12.2	9.2		
110	20.2	21.4	20.2	19.0	16.4	15.6	11.6	12.2	9.2		
115	18.0	19.2	19.0	18.4	16.2	15.2	11.6	12.2	9.2		9.4
120	16.0	17.2	17.2	17.8	15.6	14.6	11.6	12.2	9.2		9.4
125	14.2	15.4	15.4	17.4	15.2	14.2	11.6	12.0	9.2		9.4
130	12.6	13.6	13.8	16.4	14.0	13.8	11.6	11.6	9.2		9.2
135	11.0	12.0	12.2	14.6	12.4	13.2	11.6	11.2	9.0		9.0
140	9.6	10.4	10.8	13.0	11.0	12.8	11.0	10.8	8.8		8.8
145	8.2	9.0	9.4	11.6	9.8	12.6	9.8	10.6	8.6		8.6
150	7.0	7.8	8.2	10.2	8.4	12.0	8.4	10.2	8.4		8.2
155	5.8	6.4	7.0	9.0	7.4	10.6	7.4	9.8	7.2		8.0
160	4.6	5.2	5.8	7.6	6.2	9.4	6.2	9.4	6.0		7.8
165	3.6	4.2	4.8	6.6	5.2	8.2	5.2	8.2	5.0		7.6
170			3.8	5.4	4.2	7.0	4.2	7.2	4.2		7.0
175			2.8	4.4	3.2	6.0	3.4	6.2	3.2		6.0
180				3.4		5.0		5.2			5.0
185						4.0		4.2			4.2
190						3.0		3.2			3.2

THIS CHART IS ONLY A GUIDE AND SHOULD NOT BE USED TO OPERATE THE CRANE.
 The individual crane's load chart, operating instructions and other instructional plates must be read and understood prior to operating the crane.

Working range



51 - 160 ft.
(15.5 - 48.6 m)



69 - 200 ft.
(21 - 61 m)



220,400 lbs
(100 tonnes)



100%



360°

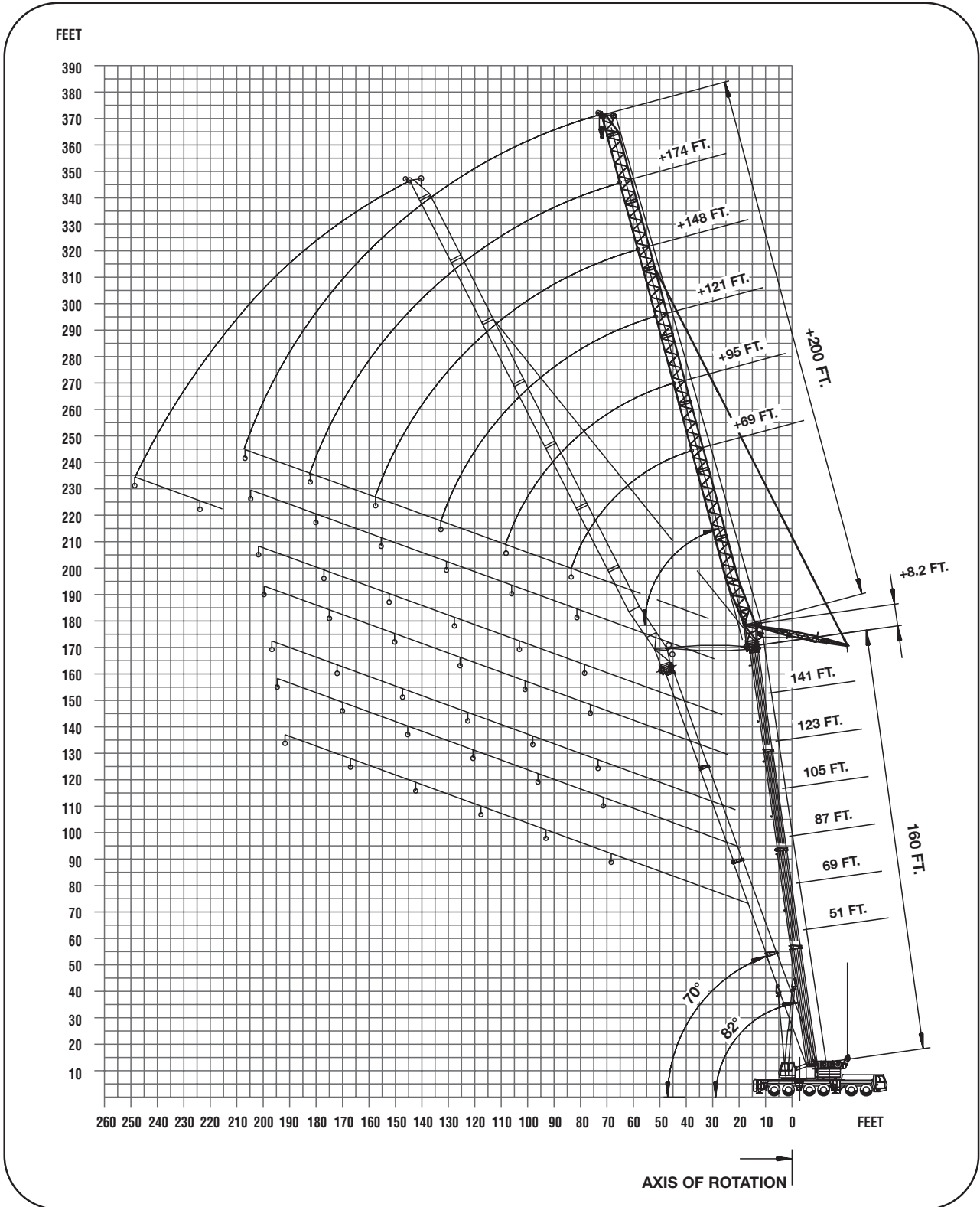

THIS CHART IS ONLY A GUIDE AND SHOULD NOT BE USED TO OPERATE THE CRANE.
The individual crane's load chart, operating instructions and other instructional plates must be read and understood prior to operating the crane.

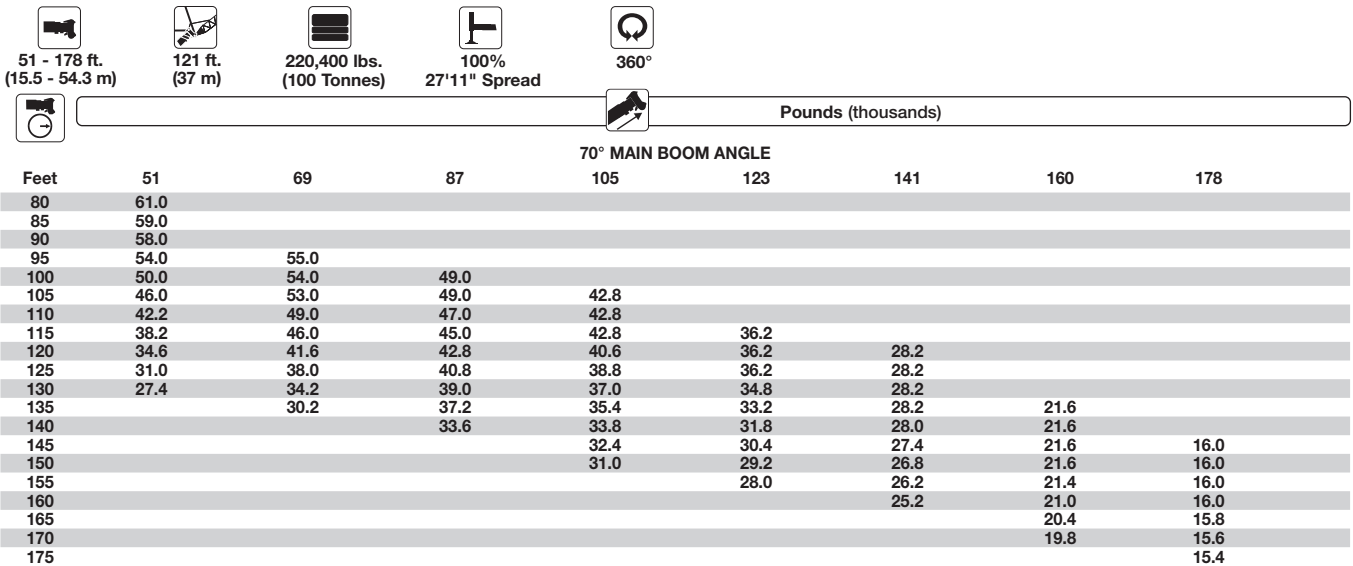
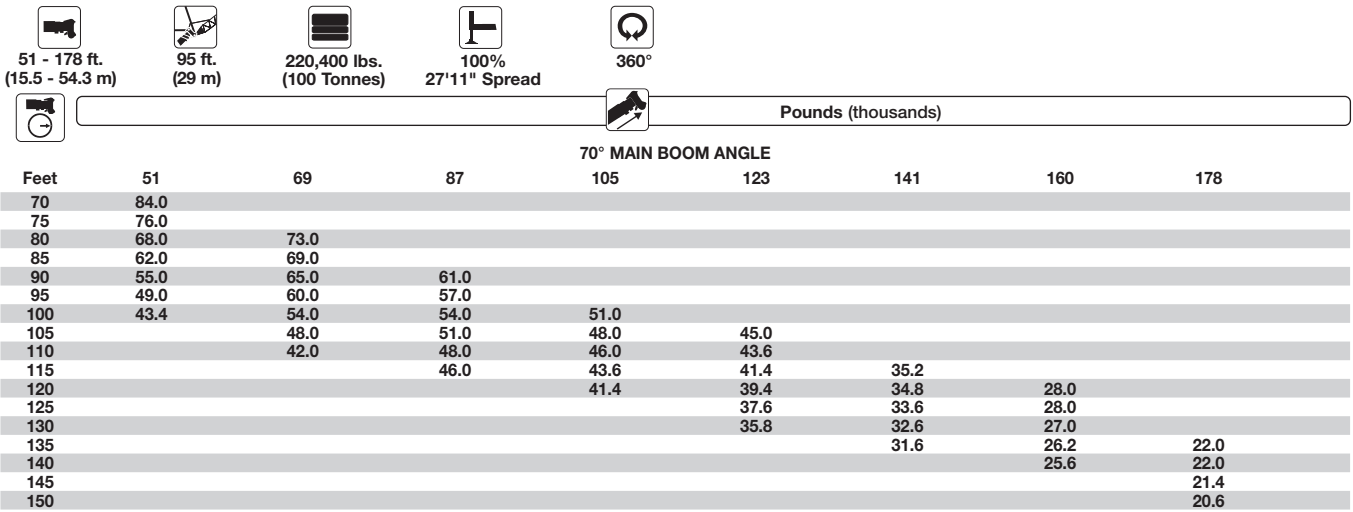
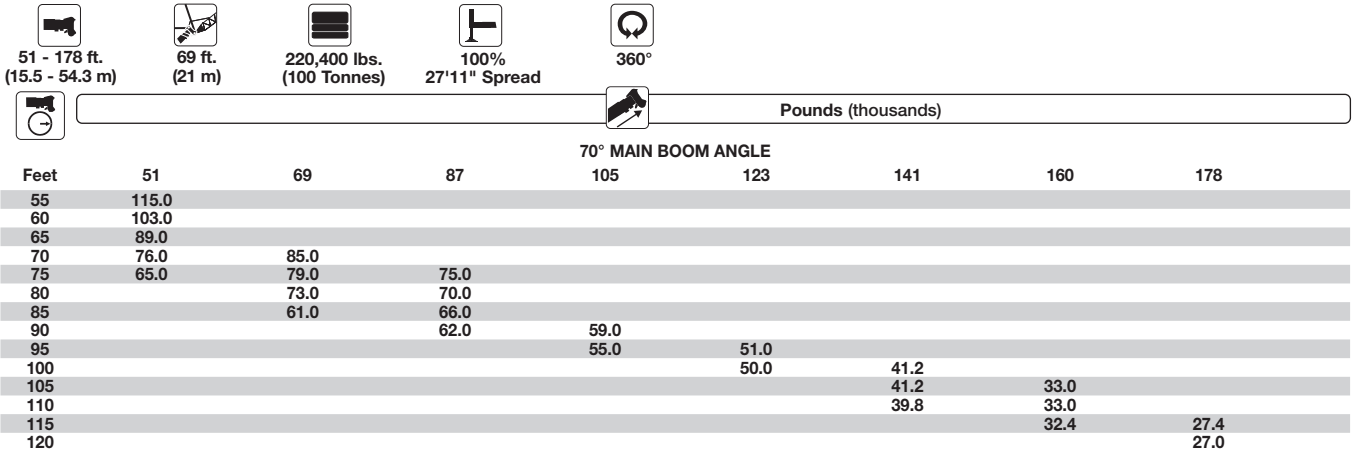

THIS CHART IS ONLY A GUIDE AND SHOULD NOT BE USED TO OPERATE THE CRANE.
 The individual crane's load chart, operating instructions and other instructional plates must be read and understood prior to operating the crane.

 51 - 178 ft. (15.5 - 54.3 m)
  148 ft. (45 m)
  220,400 lbs. (100 Tonnes)
  100% 27'11" Spread
  360°

		Pounds (thousands)							
		70° MAIN BOOM ANGLE							
Feet	51	69	87	105	123	141	160	178	
95	42.6								
100	42.4								
105	41.8	38.8							
110	41.2	38.6							
115	39.6	38.4	34.8						
120	37.4	38.0	34.8	30.6					
125	35.4	37.6	34.6	30.6	26.4				
130	32.8	36.2	34.4	30.6	26.4				
135	30.4	34.6	34.4	30.4	26.4				
140	27.8	32.6	33.8	30.4	26.4	20.8			
145	25.4	30.4	33.0	30.4	26.4	20.8	15.2		
150	23.2	27.8	32.0	30.2	26.4	20.8	15.2		
155	20.8	25.4	30.0	28.8	26.2	20.6	15.2		
160		23.0	27.4	27.8	25.8	20.6	15.2	10.8	
165			25.0	26.6	24.8	20.6	15.2	10.8	
170			22.8	25.6	23.8	20.6	15.2	10.8	
175				24.6	23.0	20.6	15.2	10.8	
180					22.0	20.2	15.2	10.8	
185						19.4	15.2	10.8	
190							15.2	10.8	
195							15.2	10.8	
200								10.8	

 51 - 178 ft. (15.5 - 54.3 m)
  174 ft. (53 m)
  220,400 lbs. (100 Tonnes)
  100% 27'11" Spread
  360°



		Pounds (thousands)							
		70° MAIN BOOM ANGLE							
Feet	51	69	87	105	123	141	160	178	
105	29.4								
110	28.6								
115	28.0								
120	27.4	26.6							
125	26.8	25.8	24.6						
130	26.2	24.8	24.2						
135	25.2	24.2	23.6	21.6					
140	24.4	23.8	23.2	21.6	18.8				
145	23.6	23.4	22.8	21.4	18.8				
150	23.0	22.8	22.4	21.2	18.8				
155	22.4	22.4	22.0	20.8	18.6	14.6			
160	21.6	21.8	21.4	20.6	18.6	14.6	10.4		
165	20.0	21.4	21.2	20.2	18.4	14.6	10.4		
170	18.4	21.0	20.8	19.8	18.4	14.6	10.4		
175	17.0	19.8	20.4	19.6	18.2	14.6	10.4	6.6	
180	15.6	18.4	19.8	19.2	17.8	14.6	10.4	6.6	
185		16.8	18.8	18.8	17.8	14.6	10.4	6.6	
190		15.6	17.8	18.6	17.6	14.6	10.4	6.6	
195			17.0	18.4	17.4	14.6	10.4	6.6	
200				18.0	17.0	14.6	10.4	6.6	
205					16.8	14.4	10.4	6.6	
210							10.4	6.6	
215							10.4	6.6	
220								6.6	

 51 - 178 ft. (15.5 - 54.3 m)
  200 ft. (61 m)
  220,400 lbs. (100 Tonnes)
  100% 27'11" Spread
  360°

		Pounds (thousands)							
		70° MAIN BOOM ANGLE							
Feet	51	69	87	105	123	141	160		
120	17.2								
125	16.4								
130	15.8								
135	15.4	16.0							
140	14.8	15.4	15.8						
145	14.4	15.0	15.2	14.8					
150	14.0	14.4	14.8	14.8					
155	13.6	14.0	14.2	14.4	12.6				
160	13.0	13.6	14.0	14.0	12.6				
165	12.6	13.2	13.4	13.6	12.6	9.8			
170	12.2	12.6	13.0	13.2	12.6	9.8			
175	11.8	12.2	12.8	12.8	12.4	9.8	6.0		
180	11.6	12.0	12.4	12.4	12.2	9.6	6.0		
185	11.4	11.6	12.0	12.0	12.0	9.4	6.0		
190	11.0	11.2	11.8	11.8	12.0	9.4	6.0		
195	10.8	11.0	11.4	11.4	11.6	9.4	6.0		
200	10.6	10.6	11.0	11.0	11.2	9.4	6.0		
205	10.2	10.4	11.0	11.0	11.0	9.4	6.0		
210		10.2	10.6	10.6	10.8	9.4	6.0		
215		10.0	10.4	10.4	10.4	9.4	6.0		
220			10.2	10.2	10.2	9.4	6.0		
225				10.0	10.0	9.4	6.0		
230					9.8	9.2	6.0		
235					9.6	9.2	6.0		
240						9.0	6.0		

THIS CHART IS ONLY A GUIDE AND SHOULD NOT BE USED TO OPERATE THE CRANE.
 The individual crane's load chart, operating instructions and other instructional plates must be read and understood prior to operating the crane.



 51 - 178 ft.
 (15.5 - 54.3 m)
  69 ft.
 (21 m)
  220,400 lbs.
 (100 Tonnes)
  100%
 27'11" Spread
  360°

  Pounds (thousands)

82° MAIN BOOM ANGLE

Feet	51	69	87	105	123	141	160	178
30	121.0							
35	121.0							
40	119.0	114.0		84.0				
45	103.0	114.0	99.0	84.0	67.0			
50	88.0	102.0	99.0	84.0	67.0	51.0	37.8	
55	75.0	88.0	96.0	84.0	67.0	51.0	37.8	29.2
60	63.0	74.0	88.0	84.0	67.0	51.0	37.8	29.2
65	52.0	62.0	74.0	84.0	67.0	51.0	37.8	29.2
70		50.0	61.0	74.0	67.0	51.0	37.8	29.2
75					67.0	51.0	37.8	29.2
80							37.8	29.2
85							37.8	29.2



 51 - 178 ft.
 (15.5 - 54.3 m)
  95 ft.
 (29 m)
  220,400 lbs.
 (100 Tonnes)
  100%
 27'11" Spread
  360°

  Pounds (thousands)

82° MAIN BOOM ANGLE

Feet	51	69	87	105	123	141	160	178
40	88.0	79.0						
45	88.0	79.0						
50	88.0	78.0	69.0	60.0				
55	84.0	78.0	69.0	60.0	49.0	37.8		
60	76.0	78.0	69.0	60.0	49.0	37.8	28.6	21.6
65	67.0	75.0	69.0	60.0	49.0	37.8	28.6	21.6
70	60.0	68.0	69.0	60.0	49.0	37.8	28.6	21.6
75	54.0	60.0	65.0	60.0	49.0	37.8	28.6	21.6
80	47.0	53.0	59.0	59.0	49.0	37.8	28.6	21.6
85	41.4	47.0	53.0	59.0	49.0	37.8	28.6	21.6
90	35.4	40.8	47.0	53.0	48.0	37.8	28.6	21.6
95			40.4	47.0	46.0	37.8	28.6	21.6
100					43.6	37.8	28.6	21.6
105							28.6	21.6
110							28.6	21.6

 51 - 178 ft.
 (15.5 - 54.3 m)
  121 ft.
 (37 m)
  220,400 lbs.
 (100 Tonnes)
  100%
 27'11" Spread
  360°

  Pounds (thousands)

82° MAIN BOOM ANGLE

Feet	51	69	87	105	123	141	160	178
50	62.0	56.0						
55	62.0	56.0		43.0				
60	61.0	55.0	50.0	43.0	36.0	28.0		
65	61.0	55.0	49.0	43.0	36.0	28.0		
70	59.0	55.0	49.0	43.0	36.0	28.0	21.4	15.8
75	56.0	55.0	49.0	42.8	36.0	28.0	21.4	15.8
80	53.0	54.0	49.0	42.8	36.0	28.0	21.4	15.8
85	48.0	51.0	49.0	42.8	36.0	28.0	21.4	15.8
90	44.0	48.0	49.0	42.6	36.0	28.0	21.4	15.8
95	40.0	45.0	47.0	42.6	36.0	28.0	21.4	15.8
100	36.2	40.6	43.8	42.4	36.0	28.0	21.4	15.8
105	32.4	36.4	40.6	42.4	36.0	28.0	21.4	15.8
110	29.0	32.6	36.6	39.0	36.0	28.0	21.4	15.8
115	25.6	28.8	32.8	35.6	36.0	28.0	21.4	15.8
120			28.6	32.2	35.4	28.0	21.4	15.8
125					32.0	28.0	21.4	15.8
130					28.6	28.0	21.4	15.8
135							21.4	15.8

THIS CHART IS ONLY A GUIDE AND SHOULD NOT BE USED TO OPERATE THE CRANE.
 The individual crane's load chart, operating instructions and other instructional plates must be read and understood prior to operating the crane.

 51 - 178 ft. (15.5 - 54.3 m)
  148 ft. (45 m)
  220,400 lbs. (100 Tonnes)
  100% 27'11" Spread
  360°



		82° MAIN BOOM ANGLE							
Feet	51	69	87	105	123	141	160	178	
50	43.8								
55	43.8	39.6							
60	43.6	39.6	35.8	31.0					
65	43.4	39.6	35.6	31.0					
70	43.2	39.2	35.6	31.0	26.6				
75	43.0	39.0	35.4	31.0	26.6	21.0	15.8	11.2	
80	42.6	39.0	35.2	30.8	26.6	21.0	15.8	11.2	
85	42.4	38.8	35.0	30.8	26.6	21.0	15.8	11.2	
90	42.0	38.4	35.0	30.6	26.6	21.0	15.8	11.2	
95	40.6	38.4	34.8	30.6	26.4	21.0	15.8	11.2	
100	38.6	37.8	34.6	30.6	26.4	21.0	15.8	11.2	
105	36.4	36.2	34.2	30.4	26.4	21.0	15.8	11.2	
110	33.6	34.8	33.6	30.4	26.4	21.0	15.8	11.2	
115	31.0	33.2	32.8	30.2	26.4	21.0	15.8	11.2	
120	28.4	31.4	32.4	30.0	26.2	21.0	15.8	11.2	
125	25.6	29.0	31.6	29.8	26.2	21.0	15.8	11.2	
130	23.4	26.2	29.2	28.2	26.0	21.0	15.8	11.2	
135	21.2	23.8	26.6	26.6	25.2	21.0	15.8	11.2	
140		21.4	24.2	24.8	24.2	21.0	15.8	11.2	
145			21.8	23.2	23.2	21.0	15.8	11.2	
150			18.8	21.4	22.0	21.0	15.8	11.2	
155					21.0	21.0	15.8	11.2	
160								11.2	

 51 - 178 ft. (15.5 - 54.3 m)
  174 ft. (53 m)
  220,400 lbs. (100 Tonnes)
  100% 27'11" Spread
  360°

		82° MAIN BOOM ANGLE							
Feet	51	69	87	105	123	141	160	178	
60	31.6								
65	31.4								
70	31.0	28.2	25.8						
75	30.4	28.2	25.6	22.2	19.0				
80	30.2	28.0	25.4	22.0	19.0	14.4	10.6		
85	29.8	27.8	25.4	22.0	19.0	14.4	10.6		
90	29.4	27.4	25.2	21.8	19.0	14.4	10.6	6.8	
95	28.8	27.4	25.0	21.8	19.0	14.4	10.6	6.8	
100	28.4	27.0	24.6	21.8	19.0	14.4	10.6	6.8	
105	27.6	26.6	24.2	21.6	19.0	14.4	10.6	6.8	
110	26.8	26.0	24.0	21.4	18.8	14.4	10.6	6.8	
115	26.0	25.4	23.6	21.2	18.8	14.4	10.6	6.8	
120	25.4	24.4	23.0	21.2	18.8	14.4	10.6	6.8	
125	24.6	23.8	22.6	21.0	18.6	14.4	10.6	6.8	
130	23.8	23.4	22.4	20.8	18.6	14.4	10.6	6.8	
135	22.8	22.8	22.0	20.4	18.4	14.4	10.6	6.8	
140	22.0	22.2	21.4	20.2	18.4	14.4	10.6	6.8	
145	21.0	21.6	21.2	19.8	18.0	14.4	10.6	6.8	
150	19.2	20.4	20.6	19.6	17.8	14.4	10.6	6.8	
155	17.4	18.8	20.2	19.4	17.8	14.4	10.6	6.8	
160	15.6	17.4	19.2	19.0	17.6	14.4	10.6	6.8	
165		16.0	17.8	18.4	17.2	14.4	10.6	6.8	
170		14.2	16.0	17.2	16.6	14.4	10.6	6.8	
175			13.8	15.8	16.0	14.4	10.6	6.8	
180					15.2	14.4	10.6	6.8	
185							10.6	6.8	
190							10.6	6.8	

THIS CHART IS ONLY A GUIDE AND SHOULD NOT BE USED TO OPERATE THE CRANE. The individual crane's load chart, operating instructions and other instructional plates must be read and understood prior to operating the crane.

 51 - 178 ft.
(15.5 - 54.3 m)
  200 ft.
(61 m)
  220,400 lbs.
(100 Tonnes)
  100%
27'11" Spread
  360°

Pounds (thousands)

Feet	82° MAIN BOOM ANGLE						
	51	69	87	105	123	141	160
70	21.6	19.8					
75	21.2	19.8	17.8				
80	20.8	19.6	17.6	15.2	12.8		
85	20.4	19.4	17.6	15.2	12.8		
90	19.6	19.4	17.4	15.2	12.8	9.2	6.2
95	19.0	18.8	17.4	15.2	12.8	9.2	6.2
100	18.4	18.0	17.4	15.2	12.8	9.2	6.2
105	17.6	17.6	16.8	15.0	12.8	9.2	6.2
110	17.2	17.0	16.4	14.8	12.8	9.2	6.2
115	16.6	16.4	16.0	14.8	12.8	9.2	6.2
120	15.8	15.8	15.6	14.6	12.6	9.2	6.2
125	15.4	15.2	15.2	14.6	12.6	9.2	6.2
130	14.8	14.8	14.6	14.4	12.6	9.2	6.2
135	14.2	14.2	14.2	14.0	12.6	9.2	6.2
140	13.8	13.8	14.0	13.8	12.4	9.2	6.2
145	13.4	13.4	13.6	13.4	12.2	9.2	6.2
150	13.0	13.0	13.0	12.8	12.2	9.2	6.2
155	12.6	12.6	12.8	12.6	12.0	9.2	6.2
160	12.2	12.2	12.4	12.2	11.8	9.2	6.2
165	11.8	11.8	12.0	11.8	11.6	9.2	6.2
170	11.6	11.6	11.8	11.6	11.2	9.2	6.2
175	11.2	11.2	11.4	11.2	11.2	9.2	6.2
180	10.6	10.8	11.0	11.0	10.8	9.2	6.2
185	10.2	10.4	11.0	10.8	10.4	9.2	6.2
190	10.0	10.2	10.6	10.4	10.4	9.2	6.2
195		9.8	10.2	10.2	10.0	9.2	6.2
200				10.0	10.0	9.2	6.2
205						9.2	6.2
210							6.2
215							6.2

THIS CHART IS ONLY A GUIDE AND SHOULD NOT BE USED TO OPERATE THE CRANE.
The individual crane's load chart, operating instructions and other instructional plates must be read and understood prior to operating the crane.

Counterweight configurations

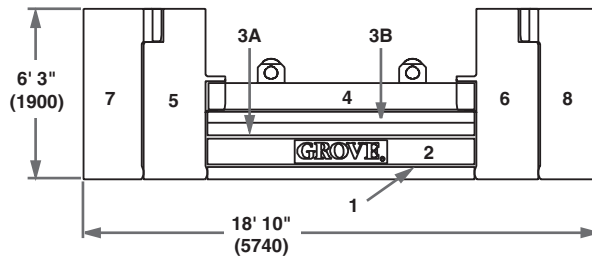

1. 17,600 lbs. (8 Tonnes)

2. 30,900 lbs. (14 Tonnes)

3A. 15,450 lbs. (7 Tonnes)

3B. 15,450 lbs. (7 Tonnes)

4. 30,900 lbs. (14 Tonnes)

5. 33,000 lbs. (15 Tonnes)

6. 33,000 lbs. (15 Tonnes)

7. 22,050 lbs. (10 Tonnes)

8. 22,050 lbs. (10 Tonnes)

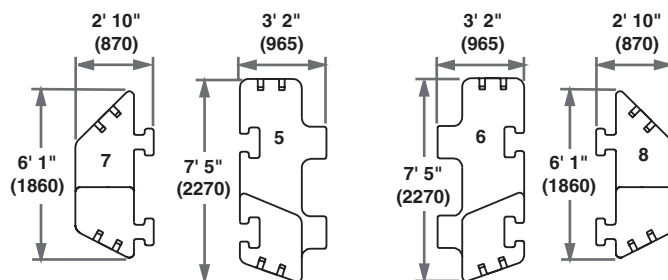
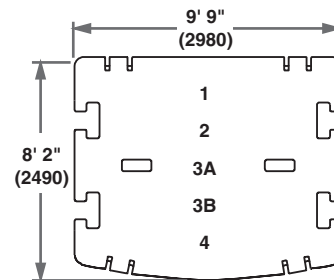
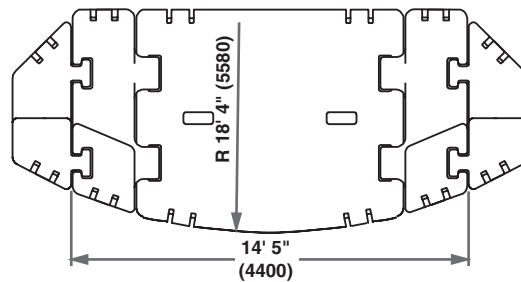

Note: () Reference dimensions in mm

	1	2	3A	3B	4	5	6	7	8
17,600 lbs.	X								
48,500 lbs.	X	X							
79,400 lbs.	X	X	X	X					
110,200 lbs.	X	X	X	X	X				
176,300 lbs.	X	X	X	X	X	X	X		
220,400 lbs.	X	X	X	X	X	X	X	X	X

THIS CHART IS ONLY A GUIDE AND SHOULD NOT BE USED TO OPERATE THE CRANE.
The individual crane's load chart, operating instructions and other instructional plates must be read and understood prior to operating the crane.

Rated Lifting Capacities

IMPORTANT NOTES:

WARNING: THIS CHART IS ONLY A GUIDE.
 The notes below are for illustration only and should not be relied upon to operate the crane. The individual crane's load chart, operating instructions and other instruction plates must be read and understood prior to operating the crane.

1. All rated loads meet ANSI/ASME B30.5, Mobile and Locomotive Cranes. Testing and development were performed to SAEJ1063, Cantilevered Boom Crane Structures - Method of Test and SAEJ765 Crane Stability Test Code.

2. Capacities given do not include the weight of hook blocks, slings, auxiliary lifting equipment and load handling devices. Their weights must be added to the load to be lifted. When more than minimum required reeving is used, the additional rope weight shall be considered part of the load.

3. The machine shall be leveled on a firm supporting surface. Depending on the nature of the supporting surface, it may be necessary to have structural supports under the outrigger floats to spread the load to a larger bearing surface.

4. When either boom length or radius or both are between values listed, the smallest load shown at either the next larger radius or next longer or shorter boom length shall be used.

















5. For outrigger operation, outriggers shall be properly extended with tires raised off the ground before operating the boom or lifting loads.

† Comparative Rating



A rating designation based upon the premise that large capacity European cranes are typically purchased and used as long boom, high reach, long radius lift cranes – not as heavy lift cranes.



To provide a GMK 6350 crane with the necessary equipment to achieve maximum lift capacity will drastically reduce long boom performance. Therefore, augmenting lifting equipment is required for buyers who require such capacities.

Symbols Glossary

	Frame		Steering
	Outriggers		Transmission
	Outrigger Controls		Axles
	Engine		Brakes
	Fuel Tank Capacity		Tires
	Electrical System		Suspension
	Drive		Rotation
	Lights		Boom Elevation
	Cab		Swing
	Boom		Counterweight
	Fixed Swingaway		Oil
	Tele-Swingaway		Hydraulic System
	Lattice Extension (Luffing)		Hoist
	Boom Nose		Radius
	Boom Extension		Boom Length
	Speed		Hookblock
	Grade		Gear
	Lattice Extension		Luffing Jib



Overview of standard duty charts



 51 ft. - 197 ft.
  360°

 28.5 x 27.9 ft.
  28.5 x 19.7 ft.



ft.	Thousand lbs.	220.4	176.3	110.2	79.3	48.5	17.6	0	220.4	176.3	110.2	79.3	48.5	17.6	0
51		•	•	•	•	•	•	•	•*	•*	•	•	•	•	•
69		•	•	•	•	•	•	•	•*	•*	•	•	•	•	•
87		•	•	•	•	•	•	•	•*	•*	•	•	•	•	•
105		•	•	•	•	•	•	•	•	•	•	•	•	•	•
124		•	•	•	•	•	•	•	•	•	•	•	•	•	•
142		•	•	•	•	•	•	•	•	•	•	•	•	•	•
160		•	•	•	•	•	•	•	•	•	•	•	•	•	•
178		•	•	•	•	•	•	•	•	•	•	•	•	•	•
197		•	•	•	•	•	•	•	•	•	•	•	•	•	•

* 0° over rear

 5° , 30°
36 ft./59 ft.
  360°

 28.5 x 27.9 ft.
  28.5 x 19.7 ft.





ft.	Thousand lbs.	220.4	176.3	110.2	79.3	48.5	17.6	110.2	79.3	48.5
51		•	•	•	•	•	•	•	•	•
69		•	•	•	•	•	•	•	•	•
87		•	•	•	•	•	•	•	•	•
105		•	•	•	•	•	•	•	•	•
124		•	•	•	•	•	•	•	•	•
142		•	•	•	•	•	•	•	•	•
160		•	•	•	•	•	•	•	•	•
178		•	•	•	•	•	•	•	•	•
197		•	•	•	•	•	•	•	•	•

 3° , 25°
62 ft./167 ft.
  360°
  28.5 x 27.9 ft.

Thousand lbs.

ft.	ft.	62	88	115	141	167	194(1)	62	88	115	141	167	194(1)	62	88	115	141	167	194(1)	62	88	115	
51		•	•	•	•	•	•	•	•	•	•	•	•	•	•	•	•	•	•	•	•	•	•
69		•	•	•	•	•	•	•	•	•	•	•	•	•	•	•	•	•	•	•	•	•	•
87		•	•	•	•	•	•	•	•	•	•	•	•	•	•	•	•	•	•	•	•	•	•
105		•	•	•	•	•	•	•	•	•	•	•	•	•	•	•	•	•	•	•	•	•	•
124		•	•	•	•	•	•	•	•	•	•	•	•	•	•	•	•	•	•	•	•	•	•
142		•	•	•	•	•	•	•	•	•	•	•	•	•	•	•	•	•	•	•	•	•	•
160		•	•	•	•	•	•	•	•	•	•	•	•	•	•	•	•	•	•	•	•	•	•
178		•	•	•	•	•	•	•	•	•	•	•	•	•	•	•	•	•	•	•	•	•	•
197		•	•	•	•	•	•	•	•	•	•	•	•	•	•	•	•	•	•	•	•	•	•

(1) 3° only

 69 ft. - 200 ft.
  82° /70°
  28.5 x 27.9 ft.
  360°

Thousand lbs.

ft.	ft.	69	95	121	147	174	200	69	95	121	147	174	200	69	95	121	147	174	200	69	95	121	147	174	200
51		•	•	•	•	•	•	•	•	•	•	•	•	•	•	•	•	•	•	•	•	•	•	•	•
69		•	•	•	•	•	•	•	•	•	•	•	•	•	•	•	•	•	•	•	•	•	•	•	•
87		•	•	•	•	•	•	•	•	•	•	•	•	•	•	•	•	•	•	•	•	•	•	•	•
105		•	•	•	•	•	•	•	•	•	•	•	•	•	•	•	•	•	•	•	•	•	•	•	•
124		•	•	•	•	•	•	•	•	•	•	•	•	•	•	•	•	•	•	•	•	•	•	•	•
142		•	•	•	•	•	•	•	•	•	•	•	•	•	•	•	•	•	•	•	•	•	•	•	•
160		•	•	•	•	•	•	•	•	•	•	•	•	•	•	•	•	•	•	•	•	•	•	•	•
178		•	•	•	•	•	•	•	•	•	•	•	•	•	•	•	•	•	•	•	•	•	•	•	•

† Only with 82° boom angle.

THIS CHART IS ONLY A GUIDE AND SHOULD NOT BE USED TO OPERATE THE CRANE.
The individual crane's load chart, operating instructions and other instructional plates must be read and understood prior to operating the crane.



▶ MEGATRAK™ is an independent suspension and all wheel steer system which allows all wheels to remain on the ground at all times so stresses and weight are not continually transferred between axles

▶ ECOS (Electronic Crane Operating System) is a computerized system that continuously monitors and controls principle crane functions as programmed by an operator



▶ EKS4 is an electronic load moment indicator that operates in conjunction with ECOS continuously displaying crane configuration and load moment data

▶ MEGAFORM™ is a “U” shape boom design which forms a natural cradle position for boom sections which eliminates stiffeners thus reducing weight and increasing capacity

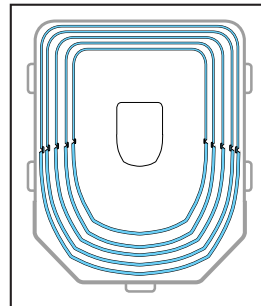

▶ TWIN-LOCK™ is a boom pinning mechanism that automatically pins the sections in position using two horizontal large diameter boom pins

