

Grove RT9130E

Product Guide



Features

- 120 t (130 USt) capacity
- 12,8 m - 48,8 m (42 ft - 160 ft) five-section, full power boom
- 11 m -18 m (36 ft - 59 ft) offsettable bi-fold swingaway extension
- 8 m (26 ft) extension inserts
- Grove MEGAFORM™ boom
- Cummins 224 kW (300 hp) Tier III, diesel engine
- Grove "E" series cab

Features



Extensions

A 18 m (59 ft) offsettable bi-fold lattice swingaway extension and two 8 m (26 ft) inserts give the RT9130E a maximum tip height of 85 m (279 ft). A hydraulically offsettable bi-fold lattice swingaway is also available, and conveniently offsets from 0° to 40° from the operator's cab.



Cab

The “E” Series cab on the RT9130E tilts up to 20° providing the operator additional comfort when working at long boom and extension lengths.

Removable outrigger boxes

Removable front and rear outrigger boxes provide up to 8788 kg (19,374 lb) of weight reduction for easier transport. Include the removable 18 100 kg (40,000 lb) of counterweight, auxiliary hoist and rope, and the RT9130E can easily self-remove close to 29 000 kg (64,000 lb).



Boom

The 48,8 m (160 ft) five-section Full Power boom incorporates the “U” shaped MEGAFORM™ design, which eliminates stiffeners, thus reducing weight and increasing capacity.

Contents

Specifications	4
Dimensions and weights	7
Working range	8
Load charts	9
Working range with inserts	13
Load chart with inserts	14
Working range - luffing	16
Load charts - luffing extension	18
Load handling	25
Notes	26

Specifications

Superstructure

Boom

12,8 m - 48,8 m (42 ft - 160 ft) five-section, sequenced synchronized full power boom. Maximum tip height: 51,5 m (169 ft)

Lattice extension

11 m - 18 m (36 ft - 59 ft) offsettable bifold lattice swingaway extension. Offsets 0°, 20° and 40°. Stows alongside base boom section. Maximum tip height: 69,2 m (227 ft)

* Optional lattice extension

11 m - 18 m (36 ft - 59 ft) hydraulically offsettable bifold lattice swingaway extension. Offsets from 0° to 40°. Stows alongside base boom section. Maximum tip height: 69,2 m (227 ft)

* Optional lattice extension inserts

Two 8 m (26 ft) lattice extension inserts. Installs between the boom nose and bifold extension, nonstowable. Maximum tip height: 85 m (279 ft)

Boom nose

Seven nylatron sheaves mounted on heavy duty tapered roller bearings with removable pin-type rope guards. Quick reeving type boom nose. Removable auxiliary boom nose with removable pin type rope guard.

Boom elevation

One double acting hydraulic cylinder with integral holding valve provides elevation from -3° to 78°.

Load moment and anti-two block system

Standard "Graphic Display" load moment and anti-two block system with audio-visual warning and control lever lockout. These systems provide electronic display of boom angle, length, radius, tip height, relative load moment, maximum permissible load, load indication and warning of impending two-block condition. The standard Work Area Definition System allows the operator to pre-select and define safe working areas. If the crane approaches the pre-set limits, audio-visual warnings aid the operator in avoiding job-site obstructions.

Cab

20° tilt, full-vision, all-steel fabricated with acoustical lining and tinted safety glass throughout. Deluxe seat incorporates armrest-mounted hydraulic single-axis controllers. Dash panel incorporates gauges for all engine functions. Other standard features include: hot water heater, cab circulating air fan, air conditioning sliding side and rear windows, sliding skylight with electric wiper and sunscreen, electric windshield wash/wipe, fire extinguisher and seat belt.

Swing

Two speed, (2) planetary swing drives with foot applied multi-disc wet brakes. Spring applied, hydraulically released swing brakes. 360° positive swing lock and two-position mechanical house lock, both operated from cab. Maximum speed: 2.5 rpm

Counterweight

18 144 kg (40,000 lb) of total counterweight. Hydraulically installed and removed.

Hydraulic system

Six main pumps with a combined capacity of 776 LPM (205 GPM).

Maximum operating pressure: 331 bar (4800 psi). Two individual post pressure compensated valve banks. Return line type filter with full flow by-pass protection and service indicator. Replaceable cartridge with micron filtration rating of 5/12/16. 1230 L (325 gal) reservoir. Remote mounted oil cooler with thermostatically controlled hydraulic driven motor, fan/air to oil. System pressure test ports.

Hoist Specifications main and auxiliary hoist

Planetary reduction with automatic spring applied multi-disc brake. Grooved drum electronic hoist drum rotation indicator, and hoist drum cable followers.

Maximum single line pull:

- 1st layer - 9083 kg (20,024 lb)
- 3rd layer - 7724 kg (17,028 lb)
- 5th layer - 6718 kg (14,811 lb)

Maximum permissible line pull:

- 7620 kg (16,800 lb) with 6 x 37 class rope
- 7620 kg (16,800 lb) with 35 x 7 class rope

Maximum single line speed: 171 m/min (562 fpm)

Specifications

Superstructure continued

Rope class:

- 6 x 37 EIPS IWRC, Special Flexible
- 35 x 7 EIPS WSC, Rotation Resistant

Rope diameter: 19 mm (3/4 in)

Rope length:

- Main hoist - 290 m (950 ft)
- Auxiliary hoist - 213 m (700 ft)

Maximum rope stowage: 368 m (1206 ft)

Carrier



Chassis

Box section frame fabricated from high-strength, low alloy steel. Removable outrigger housings, front/rear towing and tie down lugs.



Outrigger system

Four hydraulic telescoping single-stage double box beam outriggers with inverted jacks and integral holding valves. Three position settings, 0%, 50% and fully extended. Outrigger boxes removable for ease of transportation. All steel fabricated, quick release type outrigger floats, 775 m (30.5 in) diameter.

Maximum outrigger pad load - 75 298 kg (166,000 lb)



Outrigger controls

Controls and crane level indicator located in cab.



Engine (Tier III)

Cummins QSC8.3L diesel, six cylinders, 224 kW (300 bhp) (Gross) at 2200 rpm.

Maximum torque: 1356 Nm (1000 ft lb) at 1600 rpm



Fuel tank capacity

379 L (100 gal)



Transmission

Full powershift with 6 forward and 3 reverse speeds. Front axle disconnect for 4 x 2 travel.



Electrical system

Two 12 V - maintenance free batteries.
12 V starting and lighting, circuit breakers.

Drive

4 x 4



Steering

Fully independent power steering:
Front: Full hydraulic steering wheel controlled.
Rear: Full hydraulic switch controlled.
Provides infinite variations of four main steering modes: front only, rear only, crab and coordinated.
Rear steer centered indicator light.



Axles

Front: Drive/steer with differential and planetary reduction hubs rigid mounted to frame.

Rear: Drive/steer with differential and planetary reduction hubs pivot mounted to frame.



Oscillation lockouts

Automatic full hydraulic lockouts on rear axle permits 254 mm (10 in) oscillation with boom centered over the front.



Brakes

Full hydraulic split circuit, dry disc service brakes operating on all wheels. Spring-applied, hydraulically released parking brake mounted on front axle.



Tires

Standard 33.25 x 29 - 38 bias ply, Titan SL-100



Lights

Full lighting including turn indicators, head, tail, brake and hazard warning lights.

Specifications

Carrier continued

Maximum speed

24 km/h (15 mph)

Gradeability (theoretical)

73% (Based on 81 647 kg [180,000 lb] GVW) 33.25 x 29 tires, pumps engaged, 48,8 m (160 ft) boom, plus 18 m (59 ft) swingaway, 18 144 kg (40,000 lb) counterweight, hookblock and headache ball.

Miscellaneous standard equipment

Full width aluminum fenders, full length aluminum decking, dual rear view mirrors, hook-block tie down, electronic back-up alarm, light package, front stowage well, tachometer/hourmeter, immersion type block heater, rear wheel position indicator, 36,000 BTU hot water cab heater, hoist mirrors, engine distress A/V warning system, front/rear tie down and tow lugs, coolant sight level indicator, hydraulic pump disconnect, LMI light bar. Hydraulically activated boom removal pins, lift cylinder travel support, 80T hookblock, 10T top swivel ball.

* Optional equipment

- ▶ AUXILIARY LIGHTING AND CONVENIENCE PACKAGE: Includes cab mounted amber flashing light, 360° rotation spotlight and dual base boom mounted floodlights, and rubber mat for stowage trough
- ▶ 130 USt hookblock
- ▶ Rear pintle hook
- ▶ Cab controlled cross axle differential locks, (front and rear)
- ▶ PAT event recorder down load kit
- ▶ Wind speed indicator (wireless)
- ▶ Third wrap indicator with hoist cut-out (main and auxiliary)

Dimensions and weights

Dimensions

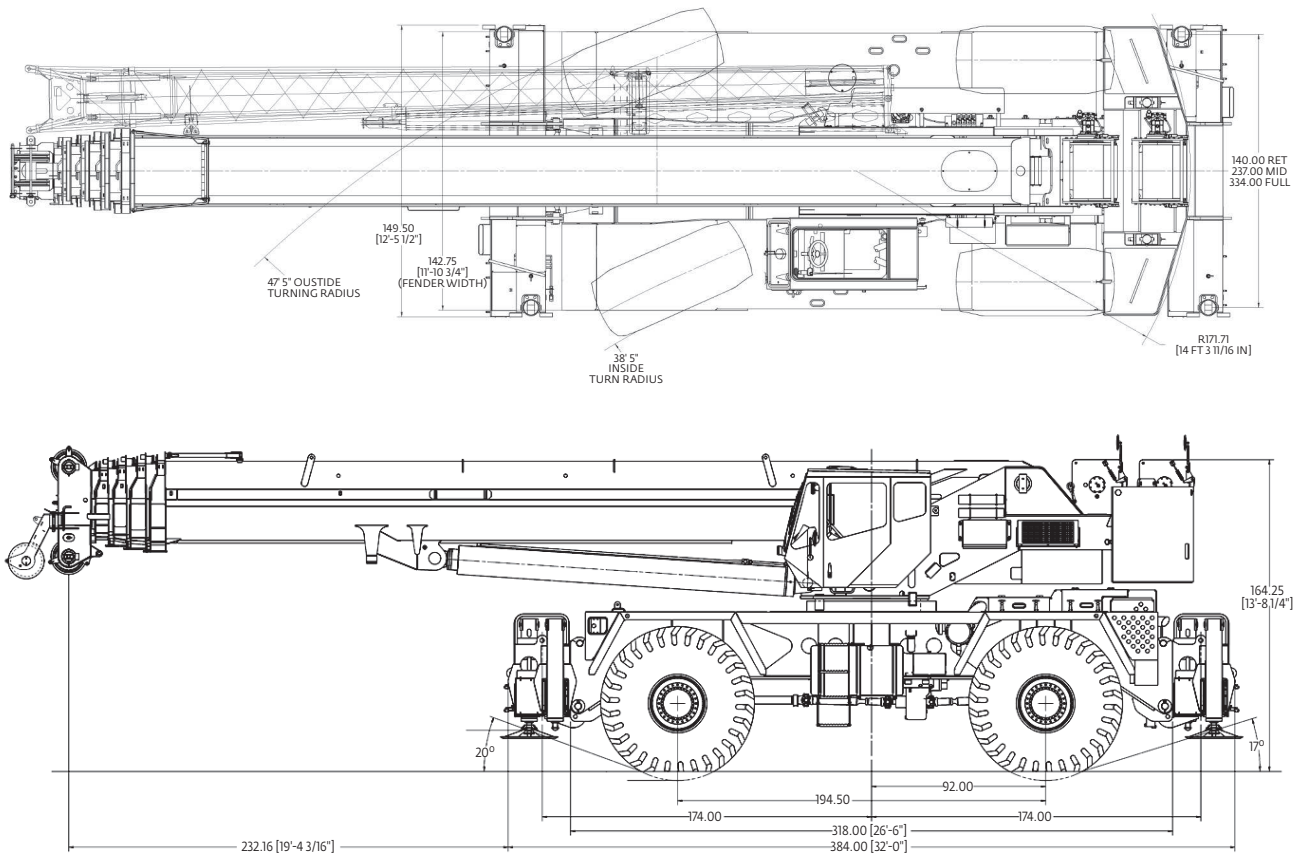

All dimensions are in inches (feet)

Weights

	Gross kg (lb)	Front kg (lb)	Rear kg (lb)	Weight of items removed
Basic Machine: Includes 160 ft main boom, main hoist with 950 ft of wire rope and auxiliary hoist with 700 ft of wire rope, manual offsettable bi-fold swingaway, full counterweight, 10 USt headache ball, and 80 USt hookblock	78 946 (174,043)	36 050 (79,475)	42 896 (94,568)	
Sub: Hydraulic offsettable bi-fold swingaway	79 222 (174,651)	36 682 (80,868)	42 540 (93,783)	
Remove: 40,000 lb counterweight, auxiliary hoist with rope, and manual offsettable swingaway	57 539 (126,849)	39 623 (87,353)	17 915 (39,496)	21 734 (47,194)
Remove: 40,000 lb counterweight, auxiliary hoist with rope, manual offsettable swingaway, 80 USt hookblock, 10 USt headache ball, and both outrigger boxes/beams	47 952 (105,715)	34 396 (75,829)	13 556 (29,886)	30 994 (68,328)
Remove: 40,000 lb counterweight, auxiliary hoist with rope, both outrigger boxes/beams, 80 USt hookblock, 10 USt headache ball, and boom assembly	32 765 (72,233)	14 051 (30,977)	18 714 (41,256)	46 181 (101,810)
Remove: 40,000 lb counterweight, auxiliary hoist with rope, both outrigger boxes/beams, 80 USt hookblock, 10 USt headache ball, boom assembly, and all tire/wheels	28 447 (62,713)	11 892 (26,217)	16 555 (36,496)	50 499 (111,330)

Working range

160 ft main boom + 36 ft - 59 ft fixed offset extension

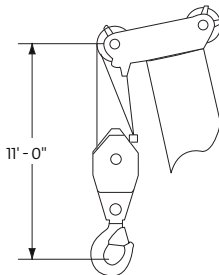
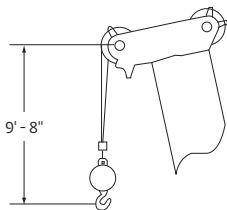
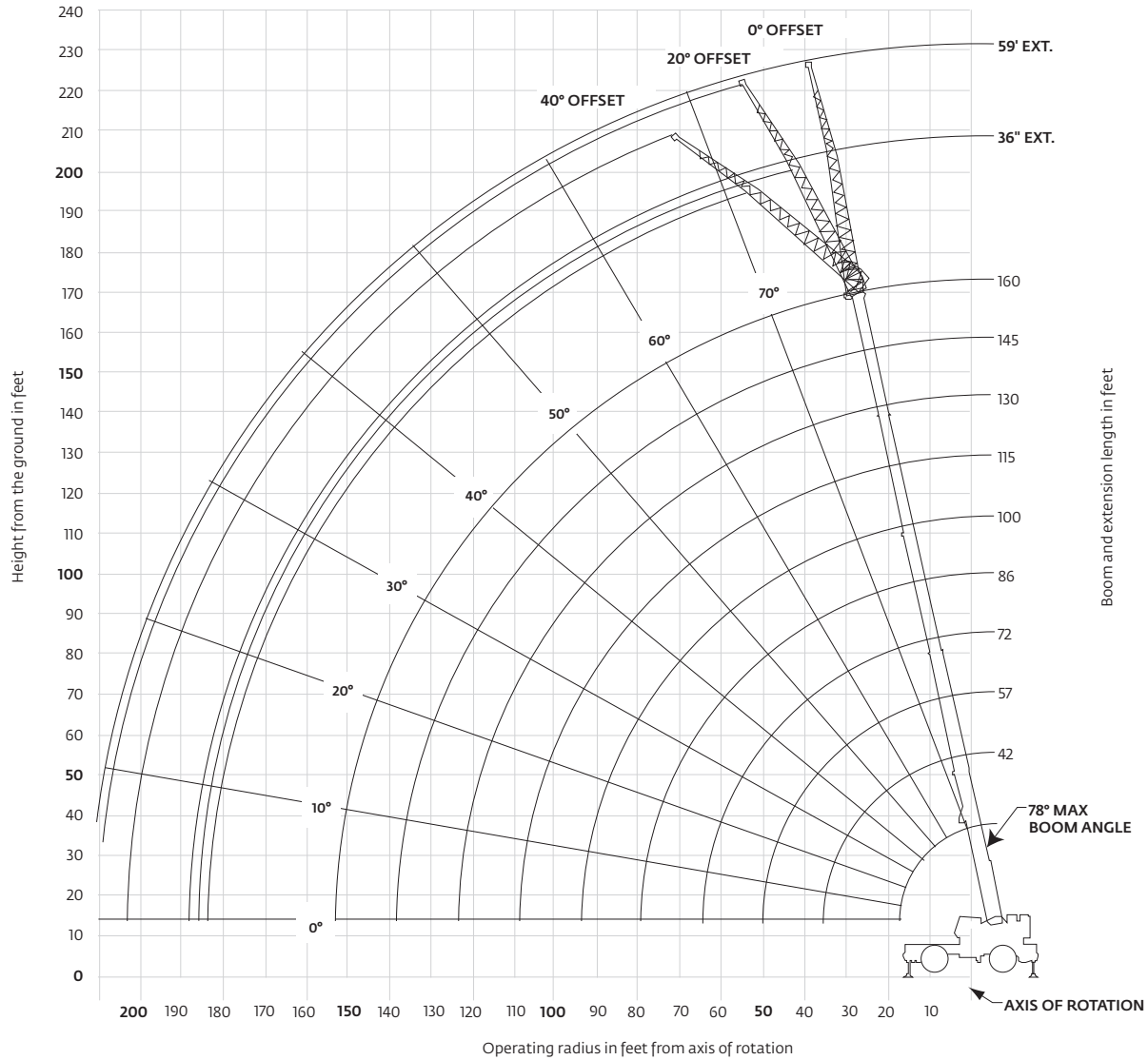

Dimensions are for largest Grove furnished hookblock and headache ball, with anti-two block activated.

Load chart

 42 ft - 160 ft
 40,000 lb
 100%
 360°
 27 ft 10 in spread

Feet	Pounds								
	#0001								
	Main boom length in feet								
	42	57	72	86	100	115	130	145	160
10	+260,000 (71.5)	147,000 (76.5)							
12	224,000 (68.5)	147,000 (74.5)	*127,000 (78)						
15	176,000 (63.5)	147,000 (71.5)	127,000 (76)	*92,600 (78)					
20	127,500 (55.5)	125,500 (65.5)	115,500 (71.5)	86,550 (75.5)	*65,000 (78)				
25	97,300 (46)	95,550 (60)	95,300 (67)	78,900 (72)	62,650 (75)	44,600 (78)			
30	76,900 (34)	75,250 (53.5)	75,050 (62.5)	68,500 (68.5)	56,800 (72)	44,600 (75.5)	43,150 (78)		
35		60,950 (46.5)	60,750 (58)	60,100 (64.5)	50,050 (69)	44,600 (73)	42,200 (76)	32,550 (78)	
40		50,300 (38.5)	50,150 (52.5)	50,550 (60.5)	44,050 (66)	41,400 (70)	38,000 (73.5)	32,550 (76)	25,100 (78)
45		42,050 (28)	41,950 (47)	42,350 (56.5)	38,950 (62.5)	37,450 (67.5)	34,150 (71)	32,550 (74)	24,800 (76.5)
50			35,400 (41)	35,850 (52.5)	34,650 (59)	33,450 (64.5)	31,350 (68.5)	29,550 (71.5)	24,500 (74.5)
55			30,050 (34)	30,550 (47.5)	30,050 (55.5)	30,000 (61.5)	29,200 (66)	26,850 (69.5)	24,000 (72.5)
60			25,600 (24.5)	26,100 (42.5)	25,850 (52)	26,950 (58.5)	26,350 (63.5)	24,700 (67.5)	23,200 (70.5)
65				22,400 (37)	22,150 (48)	23,800 (55.5)	23,850 (61)	22,950 (65)	21,100 (68.5)
70				19,200 (30.5)	18,950 (44)	20,800 (52.5)	21,600 (58.5)	20,850 (62.5)	19,200 (66.5)
75				16,400 (22)	16,200 (39)	18,100 (49)	19,250 (55.5)	19,000 (60.5)	17,500 (64.5)
80					13,800 (34)	15,700 (45.5)	16,900 (52.5)	17,100 (58)	15,750 (62.5)
85					11,650 (28)	13,550 (41.5)	15,000 (49.5)	15,500 (55.5)	14,300 (60)
90					9770 (19.5)	11,700 (37)	13,100 (46.5)	13,900 (53)	13,100 (58)
95						10,000 (32)	11,450 (43)	12,250 (50)	12,150 (55.5)
100						8490 (26.5)	9940 (39.5)	11,000 (47)	11,400 (53)
105						5690 (18.5)	8630 (35.5)	9730 (44)	10,200 (50.5)
110							7320 (30.5)	8460 (41)	9020 (48)
115							6220 (25)	7370 (37.5)	8100 (45.5)
120							5120 (17.5)	6280 (33.5)	7190 (42.5)
125								5350 (29.5)	6270 (39.5)
130								4430 (24)	5350 (36)
135								2560 (16.5)	4560 (32.5)
140									3770 (28)
Minimum boom angle (°) for indicated length (no load)									23
Maximum boom length (ft) at 0° boom angle (no load)									145

#LMI operating code. Refer to LMI manual for instructions.

*This capacity is based upon maximum obtainable boom angle.

+16 parts line required to lift this capacity (using aux. boom nose). Refer to Operator's and Safety Handbook for reeving diagram.

Note: () Boom angles are in degrees.

Lifting capacities at zero degree boom angle									
Boom Angle	Main boom length in feet								
	42	57	72	86	100	115	130	145	160
0°	41,400 (35.3)	24,650 (50)	15,350 (64.6)	9700 (79.3)	5250 (94)	3650 (108.6)	2450 (123.3)	1450 (138)	

Note: () Reference radii in feet

A6-829-103576

Load chart







Pounds						
Feet	36 ft LENGTH			59 ft LENGTH		
	0° OFFSET #0021	20° OFFSET #0022	40° OFFSET #0023	0° OFFSET #0041	20° OFFSET #0042	40° OFFSET #0043
25	[*] 33,600 (78)					
30	33,600 (76.5)			[*] 14,950 (78)		
35	32,950 (74.5)	[*] 23,150 (78)		14,950 (77.5)		
40	31,050 (72)	22,150 (76.5)		14,950 (76)		
45	29,250 (70)	21,250 (74)	17,250 (78)	14,950 (74)		
50	27,600 (67.5)	20,450 (72)	16,850 (75.5)	14,950 (72)	12,350 (78)	
55	26,150 (65)	19,700 (69.5)	16,500 (73)	14,950 (70)	11,900 (77)	
60	24,750 (63)	19,050 (67)	16,150 (70.5)	14,800 (68)	11,500 (75)	
65	23,550 (60.5)	18,450 (65)	15,900 (68)	14,300 (66)	11,100 (73)	9210 (78)
70	22,050 (58)	17,850 (62)	15,650 (65.5)	13,650 (64)	10,700 (71)	9000 (76)
75	20,100 (55.5)	17,350 (59.5)	15,450 (63)	13,100 (62)	10,400 (69)	8820 (73.5)
80	18,100 (52.5)	16,900 (57)	15,250 (60)	12,550 (60)	10,050 (66.5)	8650 (71.5)
85	16,000 (50)	16,500 (54)	15,150 (57)	12,000 (58)	9780 (64.5)	8490 (69)
90	14,150 (47)	15,500 (51.5)	15,050 (54)	11,550 (55.5)	9510 (62.5)	8360 (66.5)
95	12,500 (44)	13,700 (48)	14,000 (50.5)	11,100 (53)	9260 (60)	8240 (64)
100	11,050 (40.5)	12,100 (45)	12,750 (47)	10,650 (51)	9030 (57.5)	8130 (61.5)
105	9770 (37)	10,650 (41.5)		10,250 (48.5)	8820 (55)	8050 (59)
110	8490 (33.5)	9270 (37.5)		9930 (46)	8620 (52.5)	7980 (56)
115	7430 (29)	8060 (33)		9040 (43)	8450 (49.5)	7950 (53)
120	6370 (24)	6850 (28)		8150 (40.5)	8280 (47)	7920 (50)
125				7240 (37)	7830 (43.5)	7900 (46.5)
130				6340 (34)	7380 (40.5)	7890 (42.5)
135				5570 (30.5)	6440 (36.5)	
140				4800 (26)	5510 (32)	
145				4140 (21)		
150				3480 (14)		
Min. boom angle for indicated length (no load)	0°	20°	40°	0°	20°	40°
Max. boom length (ft) at 0° boom angle (no load)	100ft			100ft		

NOTE: () Boom angles are in degrees
 #LMI operating code. Refer to LMI for operating instructions
^{*}This capacity is based on maximum obtainable boom angle.

NOTES:

- All capacities above the bold line are based on structural strength of boom extension and do not exceed 85% of tipping loads, in accordance with SAE J-765.
- 36 ft boom extension may be used for single or double line lifting service. 59 ft boom extension may be used for single line lifting service only.
WARNING: Lifting with the 36 ft extension base, with the 23 ft extension fly either erected or folded along side of extension base, is strictly prohibited.
- Radii listed are for a fully extended boom with the boom extension erected. For main boom lengths less than fully extended, the rated loads are determined by boom angle. Use only the column which corresponds to the boom extension length and offset for which the machine is configured. For boom angles not shown, use the rating of the next lower boom angle.
WARNING: Operation of this machine with heavier loads than the capacities listed is strictly prohibited. Machine tipping with boom extension occurs rapidly and without advance warning.
- Boom angle is the angle above or below horizontal of the longitudinal axis of the boom base section after lifting rated load.
- Capacities listed are with outriggers properly extended and vertical jacks set only.

Load chart

 130 ft
  36 ft - 59 ft
  40,000 lb
  100%
27 ft 10 in
spread
  360°

Pounds						
Feet	36 ft LENGTH			59 ft LENGTH		
	0° #0021	20° #0022	40° #0023	0° #0041	20° #0042	40° #0043
35	23,350 (78)					
40	23,350 (77)			12,300 (78)		
45	23,350 (75)	*21,300 (78)		12,300 (77.5)		
50	23,350 (73.5)	20,700 (76.5)		12,300 (76)		
55	23,350 (71.5)	20,100 (75)	16,600 (78)	12,300 (74.5)		
60	23,350 (69.5)	19,500 (73)	16,350 (76)	12,300 (73)	11,600 (78)	
65	22,300 (67.5)	19,000 (71)	16,100 (74)	12,300 (71.5)	11,300 (77)	
70	20,350 (66)	18,500 (69)	15,850 (72)	12,300 (69.5)	10,950 (75)	
75	18,350 (64)	18,050 (67)	15,650 (70)	12,300 (68)	10,700 (73.5)	8940 (78)
80	16,600 (62)	17,100 (65)	15,500 (68)	12,300 (66.5)	10,400 (72)	8790 (76)
85	15,050 (60)	15,550 (63)	15,300 (66)	12,300 (64.5)	10,150 (70)	8650 (74.5)
90	13,700 (57.5)	14,150 (61)	14,500 (63.5)	12,300 (63)	9910 (68.5)	8520 (72.5)
95	12,450 (55.5)	12,900 (58.5)	13,250 (61.5)	11,900 (61)	9680 (66.5)	8410 (70.5)
100	11,300 (53.5)	11,750 (56.5)	12,100 (59)	11,450 (59)	9460 (64.5)	8300 (68.5)
105	10,300 (51)	10,750 (54)	11,050 (56.5)	10,500 (57.5)	9260 (63)	8210 (66.5)
110	9390 (48.5)	9810 (52)	10,050 (54)	9580 (55.5)	9060 (61)	8120 (64.5)
115	8570 (46)	8970 (49.5)	9200 (51.5)	8790 (53.5)	8860 (59)	8050 (62.5)
120	7750 (43.5)	8140 (46.5)	8350 (48.5)	8010 (51.5)	8660 (57)	7990 (60.5)
125	6840 (41)	7360 (44)	7600 (45.5)	7340 (49.5)	7960 (54.5)	7820 (58)
130	5940 (38)	6590 (41)	6850 (42.5)	6680 (47.5)	7270 (52.5)	7660 (55.5)
135	5170 (34.5)	5730 (37.5)		6100 (45)	6660 (50.5)	7010 (53.5)
140	4400 (31)	4880 (34)		5530 (42.5)	6050 (48)	6360 (50.5)
145	3730 (27.5)	4120 (30)		4890 (40)	5510 (45.5)	5770 (48)
150	3070 (22.5)	3360 (25.5)		4260 (37.5)	4970 (42.5)	5190 (45)
155				3670 (35)	4360 (40)	
160				3090 (31.5)	3750 (36.5)	
165				2570 (28.5)	3120 (33)	
170				2060 (24.5)	2490 (29)	
Min. boom angle for indicated length (no load)	20°	20°	40°	20°	20°	40°
Max. boom length (ft) at 0° boom angle (no load)	100 ft			100 ft		

NOTE: () Boom angles are in degrees
 #LMI operating code. Refer to LMI for operating instructions
 *This capacity is based on maximum obtainable boom angle.

NOTES:

- All capacities above the bold line are based on structural strength of boom extension and do not exceed 85% of tipping loads, in accordance with SAE J-765.
- 36 ft boom extension may be used for single or double line lifting service. 59 ft boom extension may be used for single line lifting service only.
WARNING: Lifting with the 36 ft extension base, with the 23 ft extension fly either erected or folded along side of extension base, is strictly prohibited.
- Radii listed are for a fully extended boom with the boom extension erected. For main boom lengths less than fully extended, the rated loads are determined by boom angle. Use only the column which corresponds to the boom extension length and offset for which the machine is configured. For boom angles not shown, use the rating of the next lower boom angle.
WARNING: Operation of this machine with heavier loads than the capacities listed is strictly prohibited. Machine tipping with boom extension occurs rapidly and without advance warning.
- Boom angle is the angle above or below horizontal of the longitudinal axis of the boom base section after lifting rated load.
- Capacities listed are with outriggers properly extended and vertical jacks set only.

A6-829-102127

Load chart



Pounds						
Feet	36 ft LENGTH			59 ft LENGTH		
	0° OFFSET #0021	20° OFFSET #0022	40° OFFSET #0023	0° OFFSET #0041	20° OFFSET #0042	40° OFFSET #0043
45	16,000 (78)					
50	16,000 (77.5)					
55	15,900 (76)			10,100 (78)		
60	15,850 (74)	15,700 (77.5)		10,100 (77)		
65	15,800 (72.5)	15,700 (76)	*15,200 (78)	10,100 (75.5)		
70	15,750 (71)	15,000 (74.5)	14,750 (77)	10,100 (74)	10,050 (78)	
75	14,950 (69.5)	14,300 (73)	14,100 (75.5)	10,100 (73)	10,050 (77.5)	
80	14,200 (68)	13,600 (71)	13,450 (74)	10,100 (71.5)	10,050 (76)	
85	13,450 (66)	12,950 (69.5)	12,850 (72)	10,100 (70)	10,050 (74.5)	8600 (78)
90	12,800 (64.5)	12,350 (68)	12,250 (70.5)	10,100 (68.5)	9870 (73)	8500 (77.5)
95	11,700 (63)	11,750 (66)	11,700 (68.5)	10,100 (67)	9680 (72)	8400 (75.5)
100	10,650 (61)	11,200 (64.5)	11,200 (67)	9710 (65.5)	9450 (70)	8310 (74)
105	9710 (59.5)	10,250 (62.5)	10,400 (65)	9280 (64)	9050 (68.5)	8220 (72.5)
110	8780 (57.5)	9310 (61)	9680 (63)	8850 (62.5)	8650 (67)	8140 (71)
115	7990 (55.5)	8500 (59)	8840 (61)	8110 (61)	8280 (65.5)	7920 (69.5)
120	7210 (53.5)	7690 (57)	8010 (59)	7370 (59.5)	7920 (64)	7700 (67.5)
125	6540 (52)	7000 (55)	7290 (57)	6720 (57.5)	7360 (62.5)	7440 (66)
130	5880 (49.5)	6310 (53)	6580 (55)	6070 (56)	6810 (60.5)	7190 (64)
135	5300 (47.5)	5710 (51)	5950 (53)	5510 (54.5)	6210 (59)	6630 (62.5)
140	4730 (45.5)	5110 (49)	5330 (50.5)	4950 (52.5)	5620 (57)	6080 (60.5)
145	4190 (43)	4580 (46.5)	4770 (48)	4460 (50.5)	5100 (55.5)	5520 (58.5)
150	3650 (41)	4060 (44)	4220 (45.5)	3980 (49)	4580 (53.5)	4970 (56.5)
155	3070 (38.5)	3500 (41.5)	3660 (43)	3550 (47)	4120 (51.5)	4470 (54.5)
160	2490 (35.5)	2940 (38.5)		3130 (45)	3660 (49.5)	3970 (52)
165	1970 (32.5)	2370 (36)		2710 (43)	3240 (47.5)	3510 (50)
170	1460 (29.5)	1800 (32.5)		2300 (40.5)	2830 (45)	3060 (47.5)
175				1840 (38.5)	2420 (43)	2640 (45)
180				1390 (36)	2010 (40)	2220 (42)
185					1530 (37.5)	
Min. boom angle for indicated length (no load)	26	28	40	34	35	40
Max. boom length (ft) at 0° boom angle (no load)		100			100	

NOTE: (°) Boom angles are in degrees A6-829-101980A
 #LMI operating code. Refer to LMI for operating instructions
 *This capacity is based on maximum obtainable boom angle.

NOTES:

- All capacities above the bold line are based on structural strength of boom extension and do not exceed 85% of tipping loads, in accordance with SAE J-765.
- 36 ft boom extension may be used for single or double line lifting service. 59 ft boom extension may be used for single line lifting service only.
WARNING: Lifting with the 36 ft extension base, with the 23 ft extension fly either erected or folded along side of extension base, is strictly prohibited.
- Radii listed are for a fully extended boom with the boom extension erected. For main boom lengths less than fully extended, the rated loads are determined by boom angle. Use only the column which corresponds to the boom extension length and offset for which the machine is configured. For boom angles not shown, use the rating of the next lower boom angle.
WARNING: Operation of this machine with heavier loads than the capacities listed is strictly prohibited. Machine tipping with boom extension occurs rapidly and without advance warning.
- Boom angle is the angle above or below horizontal of the longitudinal axis of the boom base section after lifting rated load.
- Capacities listed are with outriggers properly extended and vertical jacks set only.

Working range

160 ft main boom + 2 inserts + 36 ft - 59 ft fixed offset extension

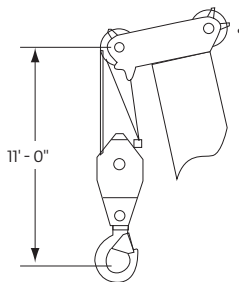
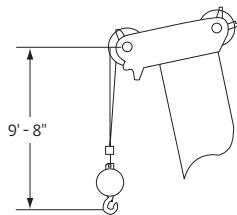
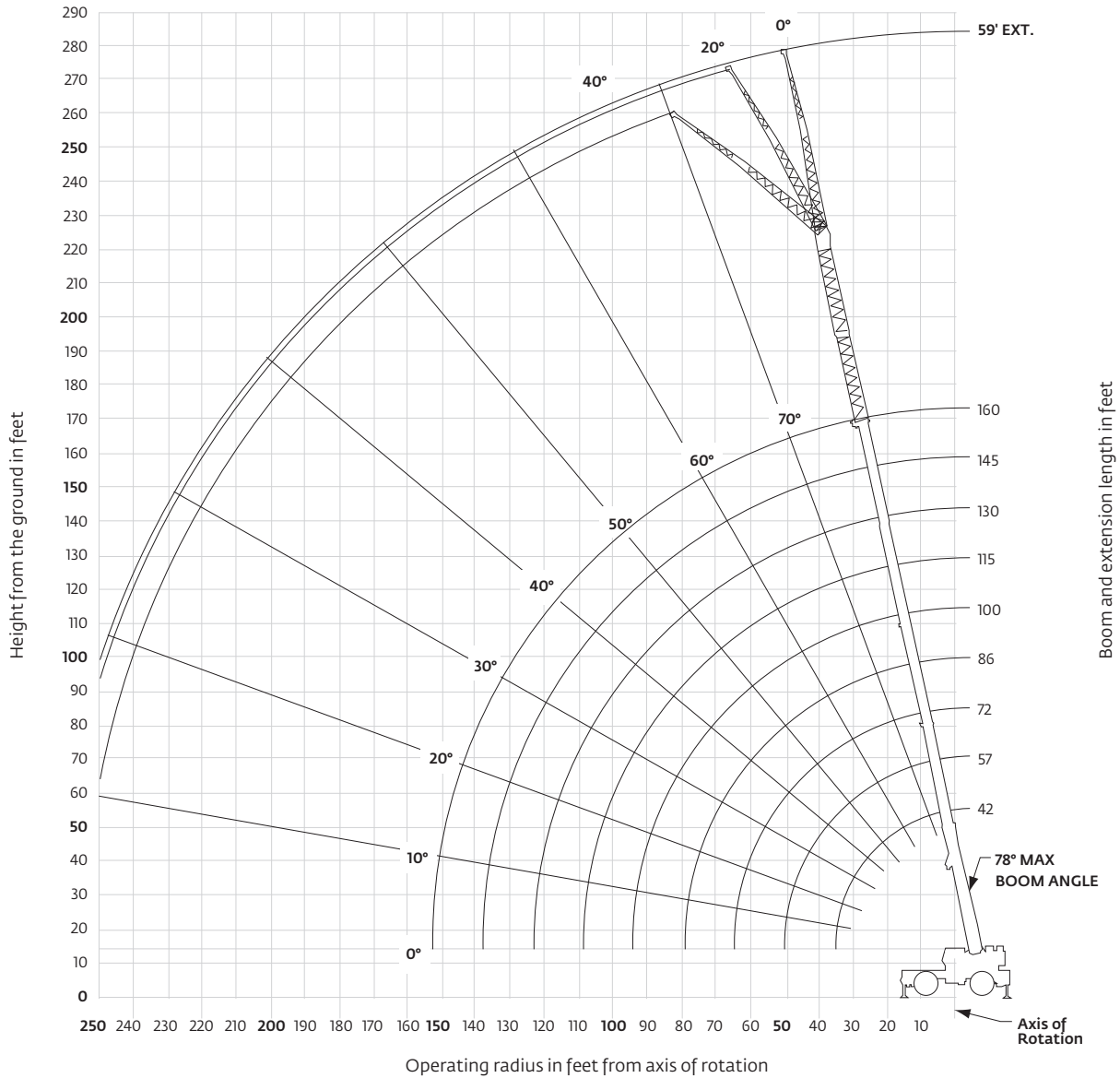

Dimensions are for largest Grove furnished hook block and headache ball, with anti-two block activated.

Load chart

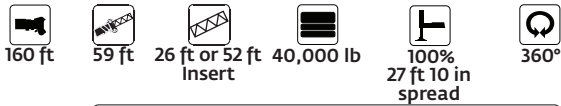

Pounds						
Feet	59 ft LENGTH WITH 26 ft INSERT			59 ft LENGTH WITH 52 ft INSERT		
	0° OFFSET #0084	20° OFFSET #0085	40° OFFSET #0086	0° OFFSET #0084	20° OFFSET #0085	40° OFFSET #0086
60	7070 (78)					
65	7070 (77.5)					
70	7070 (76.5)			4400 (78)		
75	7070 (75)			4400 (77.5)		
80	7070 (74)	6610 (78)		4400 (76.5)		
85	7070 (72.5)	6610 (77.5)		4400 (75.5)		
90	7070 (71.5)	6610 (76)		4400 (74.5)	4230 (78)	
95	7070 (70)	6610 (75)	6400 (78)	4400 (73)	4230 (77.5)	
100	7070 (69)	6610 (73.5)	6400 (77)	4400 (72)	4230 (76.5)	
105	7070 (67.5)	6610 (72.5)	6400 (76)	4400 (71.5)	4230 (75.5)	4000 (78)
110	7070 (66)	6610 (71)	6400 (74.5)	4400 (69.5)	4230 (74)	4000 (77)
115	6735 (65)	6545 (69.5)	6315 (73)	4400 (68.5)	4230 (73)	4000 (75.5)
120	6400 (63.5)	6480 (68)	6230 (71.5)	4400 (67.5)	4230 (72)	4000 (74.5)
125	5940 (62)	6170 (67)	5955 (70)	4400 (66)	4230 (70.5)	4000 (73)
130	5480 (60.5)	5860 (65.5)	5680 (68.5)	4400 (65)	4230 (69.5)	4000 (72)
135	4930 (59.5)	5510 (64)	5440 (67)	4110 (63.5)	4195 (68)	4000 (70.5)
140	4380 (58)	5160 (62.5)	5200 (65.5)	3820 (62.5)	4160 (67)	4000 (69)
145	3900 (56.5)	4645 (61)	4910 (64)	3350 (61)	3885 (65.5)	3785 (68)
150	3420 (55)	4130 (59.5)	4620 (62.5)	2880 (60)	3610 (64)	3570 (66.5)
155	3000 (53.5)	3680 (58)	4140 (60.5)	2470 (58.5)	3205 (63)	3365 (65)
160	2580 (51.5)	3230 (56.5)	3660 (59)	2060 (57)	2800 (61.5)	3160 (63.5)
165	2210 (50)	2825 (54.5)	3220 (57.5)	1690 (56)	2405 (60)	2810 (62.5)
170	1840 (48.5)	2420 (53)	2780 (55.5)		2010 (59)	2460 (61)
175	1515 (46.5)	2060 (51)	2385 (53.5)		1655 (57.5)	2075 (59.5)
180		1700 (49.5)	1990 (51.5)			1690 (58)
185		1370 (47.5)	1625 (49.5)			
Min. boom angle for indicated length (no load)	45	46	48	54	56	56
Max. boom length (ft) at 0° boom angle (no load)		57			57	

AG-829-101983A

NOTE: () Boom angles are in degrees

#LMI operating code. Refer to LMI for operating instructions

NOTES:

- All capacities above the bold line are based on structural strength of boom extension and do not exceed 85% of tipping loads, in accordance with SAE J-765.
- 59 ft folding boom extension length may be used for single line lifting service only. Note: Lifting with the 36 ft extension base with either one or two 26 ft insert sections installed is not permitted.
- For main boom lengths less than 160 ft with the boom extension erected, the rated loads are determined by boom angle. Use only the column which corresponds to the boom extension length and offset for which the machine is set up. For boom angles not shown, use the rating of the next lower boom angle.
- WARNING:** Operation of this machine with heavier loads than the capacities listed is strictly prohibited. Machine tipping with boom extension occurs rapidly and without advance warning.
- Boom angle is the angle above or below horizontal of the longitudinal axis of the boom base section after lifting rated load.
- Capacities listed are with outriggers properly extended and vertical jacks set only.

Load chart

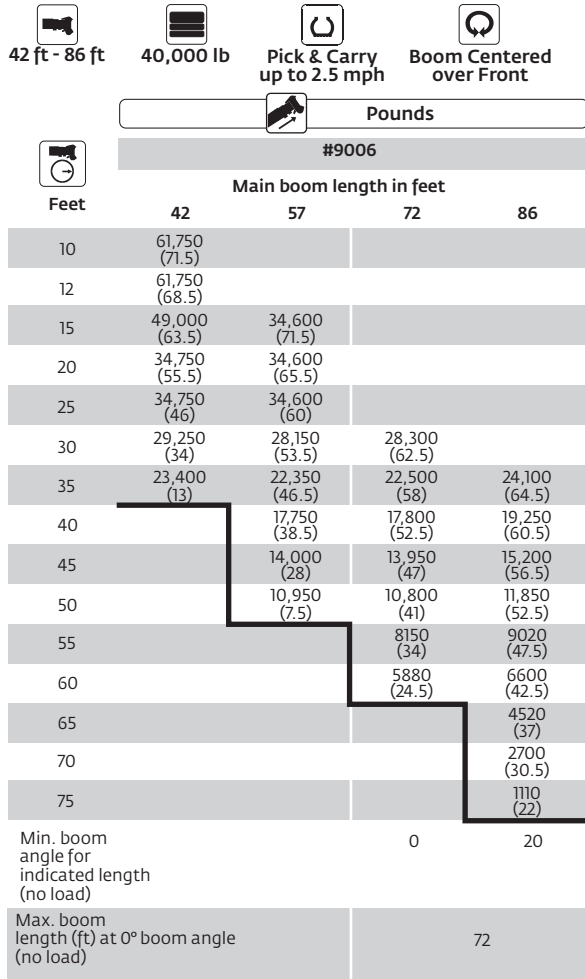

NOTE: () Boom angles are in degrees
 #LMI operating code. Refer to LMI for operating instructions

Lifting capacities at zero degree boom angle		
Boom angle	42	57
0°	23,000 (35.3)	10,900 (50)

A6-829-102108A

NOTES:

- Capacities are in pounds and do not exceed 75% of tipping loads as determined by test in accordance with SAE J-765.
- Capacities are applicable to machines equipped with 33.25x29 (38 ply) bias ply tires, at 85 psi cold inflation pressure.
- Capacities appearing above the bold line are based on structural strength and tipping should not be relied upon as a capacity limitation.
- Capacities are applicable only with machine on firm level surface.
- On rubber lifting with boom extension not permitted.
- Axle lockouts must be functioning when lifting on rubber.
- For pick and carry operation, boom must be centered over front of machine, mechanical swing lock engaged and load restrained from swinging. When handling loads in the structural range with capacities close to maximum ratings, travel should be reduced to creep speeds.
- All lifting depends on proper tire inflation, capacity and condition. Capacities must be reduced for lower tire inflation pressures. See lifting capacity chart for tire used. Damaged tires are hazardous to safe operation of crane.
- Creep – not over 200 ft of movement in any 30 minute period and not exceeding 1 mph.

Working range

160 ft main boom + 36 ft - 59 ft luffing extension

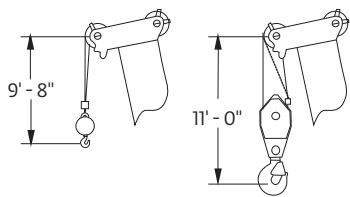
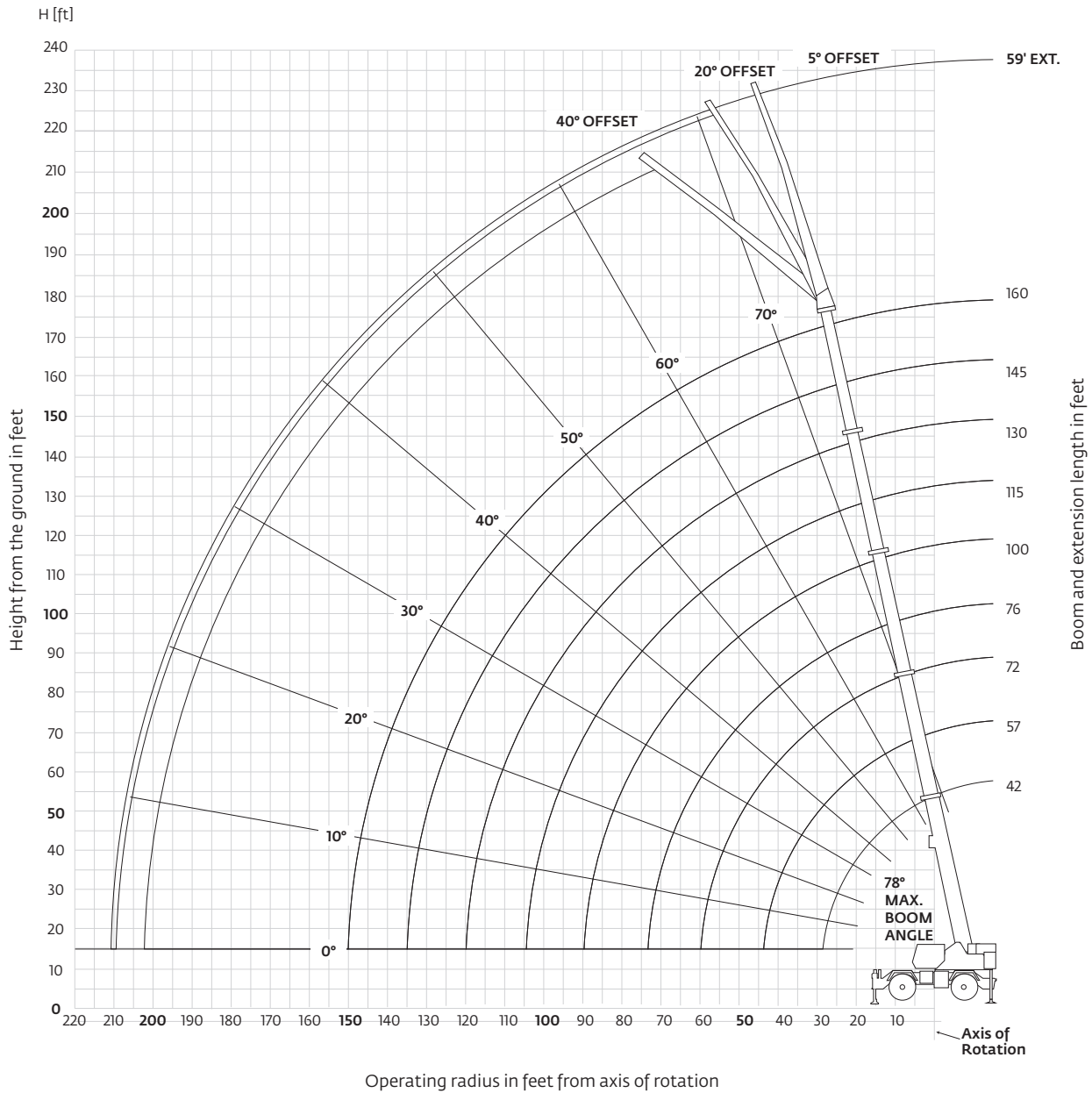

Dimensions are for largest Grove furnished hook block and headache ball, with anti-two block activated.

Working range

160 ft main boom + 2 inserts + 36 ft - 59 ft luffing extension

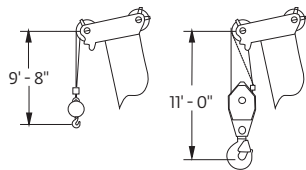
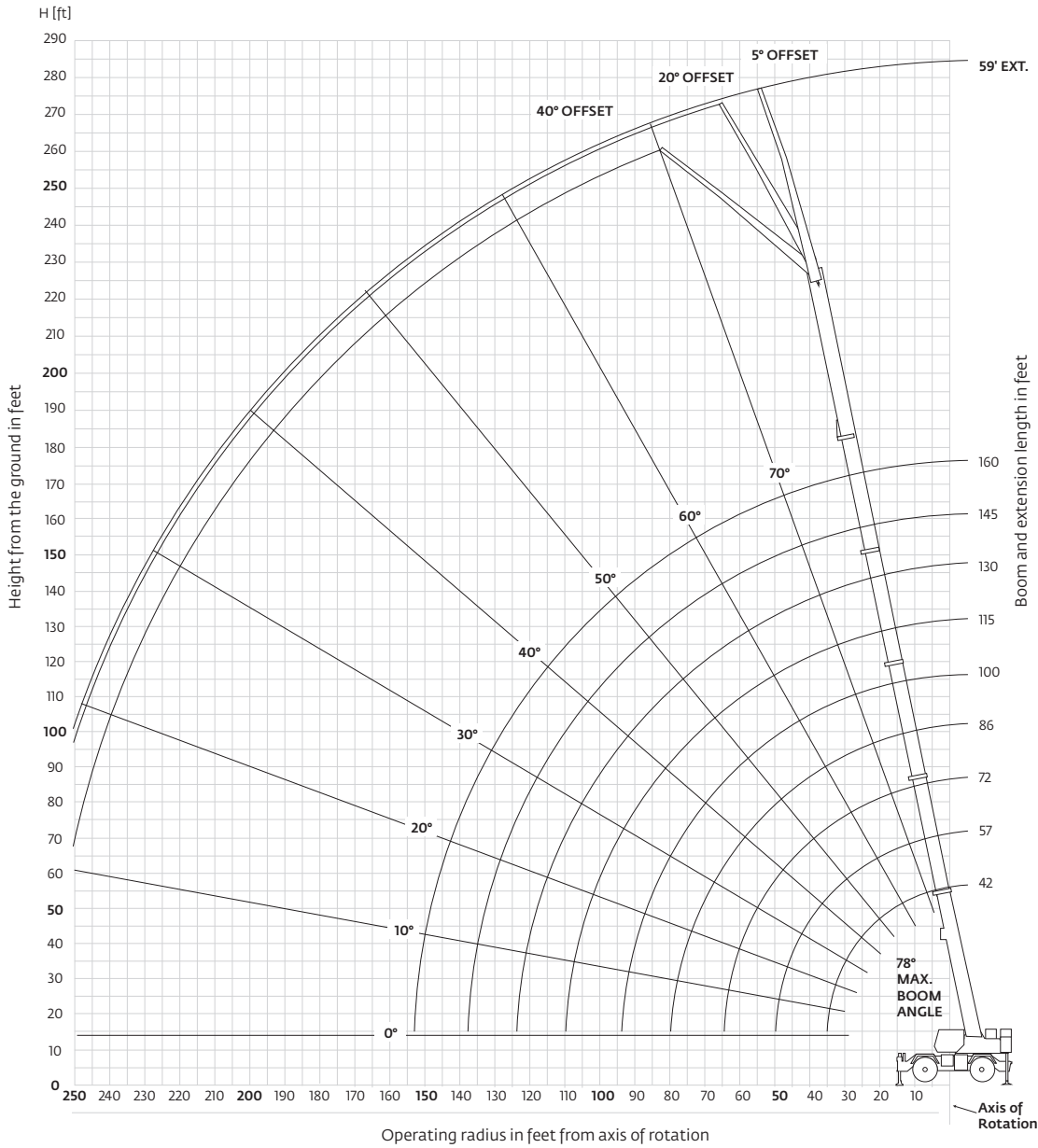

Dimensions are for largest Grove furnished hook block and headache ball, with anti-two block activated.

THIS CHART IS ONLY A GUIDE AND SHOULD NOT BE USED TO OPERATE THE CRANE.

The individual crane's load chart, operating instructions and other instructional plates must be read and understood prior to operating the crane

Load chart

36 ft - 59 ft luffing folding boom extension (fixed angle) 100 ft main boom



Feet	Pounds					
	36 ft LENGTH			59 ft LENGTH		
	5° OFFSET	20° OFFSET	40° OFFSET	5° OFFSET	20° OFFSET	40° OFFSET
30	32,600 (78)					
35	30,700 (76)	[*] 23,150 (78)				
40	28,950 (74)	22,150 (76.5)		14,950 (77.5)		
45	27,350 (71.5)	21,250 (74)	15,250 (75.5)	14,950 (75.5)		
50	25,900 (69.5)	20,450 (72)	14,850 (73.5)	14,950 (73.5)	12,350 (78)	
55	24,600 (67)	19,700 (69.5)	14,500 (73)	14,550 (72)	11,900 (77)	
60	23,400 (64.5)	19,050 (67)	14,200 (70.5)	14,150 (70)	11,500 (75)	
65	22,300 (62)	18,450 (65)	13,900 (68)	13,750 (68)	11,100 (73)	8050 (78)
70	21,300 (59.5)	17,850 (62)	13,650 (65.5)	13,350 (66)	10,700 (71)	7850 (76)
75	20,100 (57)	17,350 (59.5)	13,450 (63)	13,000 (64)	10,400 (69)	7660 (73.5)
80	18,100 (54.5)	16,900 (57)	13,300 (60)	12,550 (61.5)	10,050 (66.5)	7490 (71.5)
85	16,000 (51.5)	16,500 (54)	13,150 (57)	12,000 (59.5)	9,780 (64.5)	7340 (69)
90	14,150 (49)	15,400 (51.5)	13,050 (54)	11,550 (57.5)	9,510 (62.5)	7210 (66.5)
95	12,500 (46)	13,700 (48)	13,000 (50.5)	11,100 (55)	9,260 (60)	7090 (64)
100	11,050 (42.5)	12,100 (45)	12,750 (47)	10,650 (52.5)	9,030 (57.5)	6980 (61.5)
105	9770 (39)	10,650 (41.5)		10,250 (50)	8820 (55)	6900 (59)
110	8490 (35.5)	9270 (37.5)		9930 (47.5)	8620 (52.5)	6830 (56)
115	7400 (31)	8060 (33)		9040 (45)	8440 (49.5)	6790 (53)
120	6320 (26)	6850 (28)		8150 (42)	8260 (47)	6750 (50)
125				7240 (39)	7820 (43.5)	
130				6340 (35.5)	7380 (40.5)	
135				5570 (32)	6440 (36.5)	
140				4800 (28)	5510 (32)	
145				4100 (23)		
150				3410 (16)		

Min. boom angle for indicated length (no load)	5°	20°	40°	5°	20°	40°
Max. boom length (ft) at 5° boom angle (no load)		100 ft			100 ft	

NOTE: () Boom angles are in degrees. A6-829-102550
 #LMI operating code. Refer to LMI manual for operating instructions.
 *This capacity is based on maximum obtainable boom angle.

NOTES:

- All capacities above the bold line are based on structural strength of boom extension.
- 36 ft boom extension may be used for single or double line lifting service. 59 ft boom extension may be used for single line lifting service only.
WARNING: Lifting with the 36 ft extension base, with the 23 ft extension fly either erected or folded along side of extension base, is strictly prohibited.
- Radii listed are for a 100 ft boom with the boom extension erected. For main boom lengths less than 100 ft, the rated loads are determined by boom angle. Use only the column which corresponds to the boom extension length and offset for which the machine is configured. For boom angles not shown, use the rating of the next lower boom angle.
WARNING: Operation of this machine with heavier loads than the capacities listed is strictly prohibited. Machine tipping with boom extension occurs rapidly and without advance warning.
- Boom angle is the angle above or below horizontal of the longitudinal axis of the boom base section after lifting rated load.
- Capacities listed are with outriggers properly extended and vertical jacks set only.

Load chart

36 ft - 59 ft luffing folding boom extension (fixed angle) 130 ft main boom



Pounds						
Feet	36 ft LENGTH #0091			59 ft LENGTH #0092		
	5° OFFSET	20° OFFSET	40° OFFSET	5° OFFSET	20° OFFSET	40° OFFSET
40	*23,350 (78)					
45	23,350 (76)	*21,300 (78)		*12,300 (78)		
50	23,350 (74)	20,700 (76.5)		12,300 (77.5)		
55	23,350 (72.5)	20,100 (75)	14,850 (78)	12,300 (76)		
60	23,350 (70.5)	19,500 (73)	14,550 (76)	12,300 (74.5)	11,600 (78)	
65	22,300 (68.5)	19,000 (71)	14,300 (74)	12,300 (73)	11,300 (77)	
70	20,350 (66.5)	18,500 (69)	14,050 (72)	12,300 (71)	10,950 (75)	
75	18,350 (64.5)	18,050 (67)	13,850 (70)	12,300 (69.5)	10,700 (73.5)	7850 (78)
80	16,600 (62.5)	17,000 (65)	13,650 (68)	12,300 (68)	10,400 (72)	7690 (76)
85	15,050 (60.5)	15,450 (63)	13,450 (66)	12,300 (66)	10,150 (70)	7550 (74.5)
90	13,650 (58.5)	14,050 (61)	13,300 (63.5)	12,250 (64.5)	9910 (68.5)	7420 (72.5)
95	12,400 (56.5)	12,800 (58.5)	13,150 (61.5)	11,900 (62.5)	9680 (66.5)	7300 (70.5)
100	11,300 (54)	11,650 (56.5)	11,950 (59)	11,450 (61)	9460 (64.5)	7190 (68.5)
105	10,300 (52)	10,650 (54)	10,950 (56.5)	10,500 (59)	9,260 (63)	7090 (66.5)
110	9340 (49.5)	9660 (52)	9950 (54)	9580 (57)	9060 (61)	7000 (64.5)
115	8480 (47)	8810 (49.5)	9070 (51.5)	8790 (55)	8800 (59)	6930 (62.5)
120	7630 (44.5)	7970 (46.5)	8200 (48.5)	8010 (53)	8550 (57)	6860 (60.5)
125	6700 (41.5)	7240 (44)	7430 (45.5)	7340 (51)	7840 (54.5)	6810 (58)
130	5780 (39)	6510 (41)	6670 (42.5)	6680 (49)	7140 (52.5)	6770 (55.5)
135	4980 (35.5)	5690 (37.5)		6100 (46.5)	6520 (50.5)	6500 (53.5)
140	4190 (32)	4880 (34)		5520 (44)	5910 (48)	6240 (50.5)
145	3500 (28)	4120 (30)		4860 (42)	5360 (45.5)	5640 (48)
150	2820 (23.5)	3360 (25.5)		4200 (39)	4820 (42.5)	5050 (45)
155				3580 (36.5)	4280 (40)	
160				2970 (33.5)	3750 (36.5)	
165				2430 (30)	3120 (33)	
170				1890 (26)	2490 (29)	

Min. boom angle for indicated length (no load)

20°	20°	40°	20°	20°	40°
-----	-----	-----	-----	-----	-----

Max. boom length (ft) at 5° boom angle (no load)

100 ft	100 ft
--------	--------

NOTE: () Boom angles are in degrees. A6-829-102554
 #LMI operating code. Refer to LMI manual for operating instructions.
 *This capacity is based on maximum obtainable boom angle.

NOTES:

- All capacities above the bold line are based on structural strength of boom extension.
- 36 ft boom extension may be used for single or double line lifting service. 59 ft boom extension may be used for single line lifting service only. **WARNING:** Lifting with the 36 ft extension base, with the 23 ft extension fly either erected or folded along side of extension base, is strictly prohibited.
- Radii listed are for a 130 ft boom with the boom extension erected. For main boom lengths less than 130 ft, the rated loads are determined by boom angle. Use only the column which corresponds to the boom extension length and offset for which the machine is configured. For boom angles not shown, use the rating of the next lower boom angle. **WARNING:** Operation of this machine with heavier loads than the capacities listed is strictly prohibited. Machine tipping with boom extension occurs rapidly and without advance warning.
- Boom angle is the angle above or below horizontal of the longitudinal axis of the boom base section after lifting rated load.
- Capacities listed are with outriggers properly extended and vertical jacks set only.

Load chart

36 ft - 59 ft luffing folding boom extension (fixed angle) 160 ft main boom



Pounds						
Feet	36 ft LENGTH			59 ft LENGTH		
	5° OFFSET	20° OFFSET #0091	40° OFFSET	5° OFFSET	20° OFFSET #0092	40° OFFSET
50	15,550 (77.5)					
55	15,550 (76)					
60	15,550 (74.5)	14,950 (77.5)		9650 (78)		
65	15,550 (73)	14,950 (76)	14,400 (78)	9650 (77)		
70	15,550 (71.5)	14,950 (74.5)	14,150 (77)	9650 (75.5)	9650 (78)	
75	14,900 (70)	14,250 (73)	13,950 (75.5)	9650 (74)	9650 (77.5)	
80	14,100 (68)	13,550 (71)	13,400 (74)	9650 (72.5)	9650 (76)	
85	13,400 (66.5)	12,900 (69.5)	12,800 (72)	9650 (71)	9650 (74.5)	7630 (78)
90	12,700 (65)	12,250 (68)	12,200 (70.5)	9650 (69.5)	9650 (73)	7510 (77.5)
95	11,500 (63)	11,700 (66)	11,650 (68.5)	9650 (68.5)	9650 (72)	7390 (75.5)
100	10,400 (61.5)	10,850 (64.5)	11,100 (67)	9570 (67)	9420 (70)	7290 (74)
105	9480 (59.5)	9910 (62.5)	10,200 (65)	9150 (65)	9010 (68.5)	7200 (72.5)
110	8570 (58)	8970 (61)	9360 (63)	8730 (63.5)	8610 (67)	7110 (71)
115	7780 (56)	8160 (59)	8530 (61)	8000 (62)	8220 (65.5)	7030 (69.5)
120	6990 (54)	7360 (57)	7700 (59)	7280 (60.5)	7840 (64)	6950 (67.5)
125	6320 (52)	6670 (55)	6980 (57)	6620 (59)	7180 (62.5)	6890 (66)
130	5650 (50)	5980 (53)	6260 (55)	5970 (57.5)	6530 (60.5)	6830 (64)
135	5070 (48)	5380 (51)	5630 (53)	5400 (55.5)	5930 (59)	6320 (62.5)
140	4500 (46)	4780 (49)	5010 (50.5)	4830 (54)	5340 (57)	5820 (60.5)
145	3990 (43.5)	4250 (46.5)	4450 (48)	4340 (52)	4820 (55.5)	5260 (58.5)
150	3490 (41.5)	3730 (44)	3900 (45.5)	3850 (50)	4300 (53.5)	4710 (56.5)
155	2990 (38.5)	3260 (41.5)		3410 (48)	3840 (51.5)	4210 (54.5)
160	2490 (36)	2800 (38.5)		2980 (46)	3380 (49.5)	3710 (52)
165	1970 (33)	2300 (36)		2590 (44)	2960 (47.5)	3250 (50)
170	1450 (30)	1800 (32.5)		2210 (42)	2550 (45)	2790 (47.5)
175				1800 (39.5)	2170 (43)	
180				1390 (37.5)	1800 (40)	
185					1420 (37.5)	
Min. boom angle for indicated length (no load)	26°	29°	40°	34°	36°	40°
Max. boom length (ft) at 5° boom angle (no load)	100 ft			100 ft		

NOTE: () Boom angles are in degrees. A6-829-102558
 #LMI operating code. Refer to LMI manual for operating instructions.
 *This capacity is based on maximum obtainable boom angle.

NOTES:

- All capacities above the bold line are based on structural strength of boom extension and do not exceed 85% of tipping loads, in accordance with SAE J765.
- 36 ft boom extension may be used for single or double line lifting service. 59 ft boom extension may be used for single line lifting service only.
WARNING: Lifting with the 36 ft extension base, with the 23 ft extension fly either erected or folded along side of extension base, is strictly prohibited.
- Radii listed are for a 160 ft boom with the boom extension erected. For main boom lengths less than 160 ft, the rated loads are determined by boom angle. Use only the column which corresponds to the boom extension length and offset for which the machine is configured. For boom angles not shown, use the rating of the next lower boom angle.
WARNING: Operation of this machine with heavier loads than the capacities listed is strictly prohibited. Machine tipping with boom extension occurs rapidly and without advance warning.
- Boom angle is the angle above or below horizontal of the longitudinal axis of the boom base section after lifting rated load.
- Capacities listed are with outriggers properly extended and vertical jacks set only.

Load chart

59 ft luffing folding boom extension with 1 or 2 inserts (fixed angle) 160 ft main boom

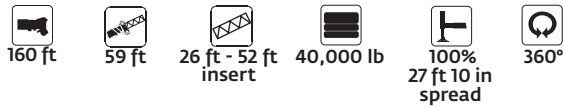

Pounds						
Feet	59 ft LENGTH WITH 26 ft INSERT			59 ft LENGTH WITH 52 ft INSERT		
	5° OFFSET	20° OFFSET #0095	40° OFFSET	5° OFFSET	20° OFFSET #1095	40° OFFSET
70	6830 (78)					
75	6830 (77)			4400 (78)		
80	6830 (75.5)	6610 (78)		4400 (77.5)		
85	6830 (74.5)	6610 (77.5)		4400 (76.5)		
90	6830 (73)	6610 (76)		4400 (75.5)	4230 (78)	
95	6830 (72)	6610 (75)	6400 (78)	4400 (74.5)	4230 (77.5)	
100	6830 (70.5)	6610 (73.5)	6400 (77)	4400 (73)	4230 (76.5)	
105	6830 (69.5)	6610 (72.5)	6400 (76)	4400 (72)	4230 (75.5)	4000 (78)
110	6830 (68)	6610 (71)	6400 (74.5)	4400 (71)	4230 (74)	4000 (77)
115	6590 (66.5)	6520 (69.5)	6310 (73)	4400 (69.5)	4230 (73)	4000 (75.5)
120	6350 (65)	6430 (68)	6230 (71.5)	4400 (68.5)	4230 (72)	4000 (74.5)
125	5910 (64)	6120 (67)	5950 (70)	4400 (67.5)	4230 (70.5)	4000 (73)
130	5480 (62.5)	5810 (65.5)	5680 (68.5)	4400 (66)	4230 (69.5)	4000 (72)
135	4930 (61)	5480 (64)	5430 (67)	4110 (65)	4170 (68)	4000 (70.5)
140	4380 (59.5)	5160 (62.5)	5190 (65.5)	3820 (63.5)	4120 (67)	4000 (69)
145	3900 (58)	4640 (61)	4900 (64)	3350 (62.5)	3860 (65.5)	3780 (68)
150	3420 (56.5)	4130 (59.5)	4620 (62.5)	2880 (61)	3610 (64)	3570 (66.5)
155	3000 (55)	3680 (58)	4140 (60.5)	2470 (59.5)	3200 (63)	3360 (65)
160	2580 (53.5)	3230 (56.5)	3660 (59)	2060 (58.5)	2800 (61.5)	3160 (63.5)
165	2210 (52)	2820 (54.5)	3220 (57.5)	1690 (57)	2400 (60)	2810 (62.5)
170	1840 (50)	2420 (53)	2780 (55.5)		2010 (59)	2460 (61)
175	1510 (48.5)	2060 (51)	2380 (53.5)		1650 (57.5)	2070 (59.5)
180		1700 (49.5)	1990 (51.5)			1690 (58)

Min. boom angle for indicated length (no load)

Max. boom length (ft) at 5° boom angle (no load)

NOTE: () Boom angles are in degrees. A6-829-102562 #LMI operating code. Refer to LMI manual for operating instructions.

NOTES:

- All capacities above the bold line are based on structural strength of boom extension and do not exceed 85% of tipping loads, in accordance with SAE J-765.
- 59 ft folding boom extension length may be used for single line lifting service only. NOTE: Lifting with the 36 ft extension base with either one or two 26 ft insert sections installed is not permitted.
- For main boom lengths less than 160 ft with the boom extension erected, the rated loads are determined by boom angle. Use only the column which corresponds to the boom extension length and offset for which the machine is set up. For boom angles not shown, use the rating of the next lower boom angle.
- WARNING:** Operation of this machine with heavier loads than the capacities listed is strictly prohibited. Machine tipping with boom extension occurs rapidly and without advance warning.
- Boom angle is the angle above or below horizontal of the longitudinal axis of the boom base section after lifting rated load.
- Capacities listed are with outriggers properly extended and vertical jacks set only.

Load chart

36 ft - 59 ft luffing folding boom extension 160 ft main boom (load luffing)



Pounds				
Feet	36 ft LENGTH		59 ft LENGTH	
	5° - 20° OFFSET #0091	20° - 40° OFFSET	5° - 20° OFFSET	20° - 40° OFFSET #0092
60	14,950			
65	14,950	10,250		
70	14,950	10,050	9650	
75	14,250	9840	9320	
80	13,550	9640	8950	
85	12,900	9460	8600	5100
90	12,250	9280	8290	4980
95	11,500	9130	7990	4880
100	10,400	8980	7720	4780
105	9480	8850	7470	4690
110	8570	8720	7220	4600
115	7780	8160	7010	4520
120	6990	7360	6790	4440
125	6320	6670	6600	4370
130	5650	5980	5970	4310
135	5070	5380	5400	4250
140	4500	4780	4830	4200
145	3990	4250	4340	4160
150	3490	3730	3850	4120
155	2990		3410	3840
160	2490		2980	3380
165	1970		2590	2960
170	1450		2210	2550
175			1800	
180			1390	
Min. boom angle for indicated length (no load)	29°	40°	36°	40°
Max. boom length (ft) at 5° boom angle (no load)	100 ft		100 ft	

A6-829-102575







#LMI operating code. Refer to LMI for operating instructions

NOTES:

1. All capacities above the bold line are based on structural strength of boom extension and do not exceed 85% of tipping loads, in accordance with SAE J-765.
2. 36 ft boom extension length may be used for single or double line lifting service. 59 ft boom extension may be used for single line lifting service only.
WARNING: Lifting with the 36 ft extension base, with the 23 ft extension fly either erected or folded along side of extension base, is strictly prohibited.
3. Capacities are applicable for a 160 ft main boom length only.
WARNING: Operation of this machine with heavier loads than the capacities listed is strictly prohibited. Machine tipping with boom extension occurs rapidly and without advance warning.
4. The loads for luffing depend on the angle of the main boom, angle of the boom extension and dynamic working pressure of the luffing cylinder for the boom extension.
5. Capacities listed are with outriggers properly extended and vertical jacks set only.

Load chart

59 ft luffing folding boom extension with 1 or 2 inserts 160 ft main boom (load luffing)

 160 ft  59 ft  26 ft - 52 ft Insert  40,000 lb  100% 27 ft 10 in spread  360°				
Pounds				
Feet	59 ft LENGTH with 26 ft INSERT #0095		59 ft LENGTH with 52 ft INSERT #1095	
	5° - 20° OFFSET	20° - 40° OFFSET	5° - 20° OFFSET	20° - 40° OFFSET
80	6610			
85	6610			
90	6610		4230	
95	6610	4420	4230	
100	6610	4330	4230	
105	6610	4250	4230	4000
110	6430	4180	4230	4000
115	6250	4100	4230	4000
120	6070	4020	4230	4000
125	5900	3970	4230	4000
130	5480	3920	4230	4000
135	4930	3870	4110	4000
140	4380	3810	3820	3960
145	3900	3770	3350	3780
150	3420	3730	2880	3570
155	3000	3680	2470	3200
160	2580	3230	2060	2800
165	2210	2820	1690	2400
170	1840	2420		2010
175	1510	2060		1650
180		1700		
Min. boom angle for indicated length (no load)	46°	48°	56°	56°
Max. boom length (ft) at 5° boom angle (no load)	57 ft		57 ft	

#LMI operating code. Refer to LMI manual for operating instructions. A6-829-102579

NOTES:

- All capacities above the bold line are based on structural strength of boom extension and do not exceed 85% of tipping loads, in accordance with SAE J-765.
- 59 ft boom extension may be used for single line lifting service only.
WARNING: Lifting with the 36 ft extension base, with either one or two 26 ft insert sections installed is not permitted.
- Capacities are applicable for a 160 ft main boom length only.
WARNING: Operation of this machine with heavier loads than the capacities listed is strictly prohibited. Machine tipping with boom extension occurs rapidly and without advance warning.
- The loads for luffing depend on the angle of the main boom, angle of the boom extension and dynamic working pressure of the luffing cylinder for the boom extension.
- Capacities listed are with outriggers properly extended and vertical jacks set only.

THIS CHART IS ONLY A GUIDE AND SHOULD NOT BE USED TO OPERATE THE CRANE.

Load chart

Installation and removal of counterweight and auxiliary hoist rated lifting capacities in pounds

On outriggers fully extended- 360°	
Radius in feet	#0801 Main boom length 42 ft*
10	48,000
12	48,000
15	48,000
20	48,000
25	48,000
30	48,000

Installation and removal of front and rear outrigger boxes rated lifting capacities in pounds without counterweight

On rubber (stationary) - 360°	
Radius in feet	#9810 Main boom length 42 ft*
10	11,600
12	11,600
15	11,600
20	11,600

* The boom must be fully retracted.

Notes for on rubber

- Capacities are applicable to machines equipped with Titan 33.25 x 29 (38 ply) tires at 85 psi cold inflation pressure. Capacities do not exceed 75% of tipping loads as determined by test in accordance with SAE J765.
- With no load, the boom angle must not be less than 35° when over sides of machine since loss of stability will occur causing a tipping condition. To lower boom below 35° boom angle, boom must be swung over front or rear and LMI bypass activated.
- Once one outrigger box is installed, do not swing load over that end of the machine while installing the other outrigger box.
- Each outrigger box assembly weighs 9373 lb including the outrigger beams and pads.
- May be used for single or double line lifting service.

Load handling

Weight reductions for load handling devices

36 ft - 59 ft luffing folding boom extension	Pounds
*36 ft extension (erected)	5260
*59 ft extension (erected)	9860
Luffing extension with 26 ft insert	Pounds
*59 ft extension (erected)	14,100
Luffing extension with 52 ft insert	Pounds
*59 ft extension (erected)	19,400

When lifting over boom nose with 36 ft or 59 ft extension erected, the outriggers must be fully extended or 50% extended (19 ft 9 in) spread.

When lifting over main boom nose with 36 ft or 52 ft insert erected, the outriggers must be fully extended.

Auxiliary boom nose	Pounds
	120
Hookblocks and headache balls	Pounds
80 USt, 5-sheave	1600+
130 USt, 8-sheave	2400+
10 USt overhaul ball	690+
+Refer to rating plate for actual weight.	

When lifting over swingaway and/or jib combinations, deduct total weight of all load handling devices reeved over main boom nose directly from swingaway or jib capacity.

NOTE: All load handling devices and boom attachments are considered part of the load and suitable allowances **MUST BE MADE** for their combined weights. Weights are for Grove furnished equipment.

Reeving diagram

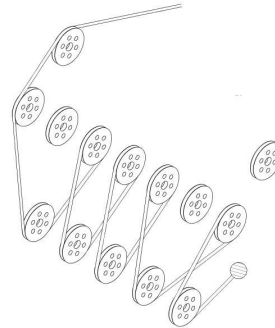

Line pulls and reeving information

Hoists	Cable specs	Permissible line pulls	Nominal cable length
Main Model 35	19 mm (3/4 in) 6 x 37 class, EIPS, IWRC Special Flexible Min. Breaking Str. 58,800 lb	16,800 lb	950 ft
Main Model 35	19 mm (3/4 in) Flex-X 35 Rotation resistant (non-rotating) Min. breaking Str. 85,500 lb	16,800 lb	950 ft
Auxiliary Model 35	19 mm (3/4 in) Flex-X 35 Rotation resistant (non-rotating) Min. breaking Str. 85,500 lb	16,800 lb	700 ft

The approximate weight of 3/4 in wire rope is 1.5 lb/ft

Hoist performance

Wire rope layer	Hoist line pulls two-speed hoist		Drum rope capacity (ft)	
	Low available lb*	High available lb*	Layer	Total
1	20,024	12,496	140	140
2	18,405	11,485	152	293
3	17,028	10,626	165	458
4	15,842	9886	177	636
5	14,811	9243	190	826
6	13,906	8678	202	1028

* Max lifting capacity:
6 x 37 class or 35 x 7 class = 16,800 lb

Working area diagram

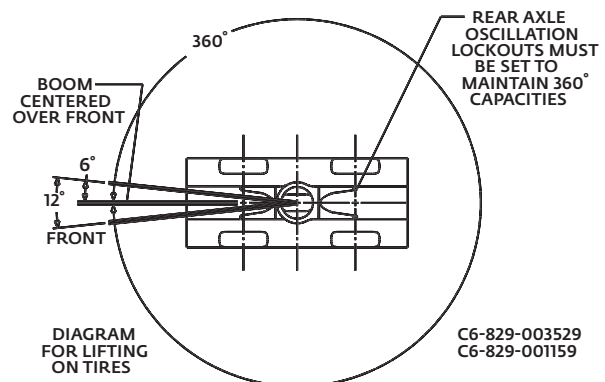
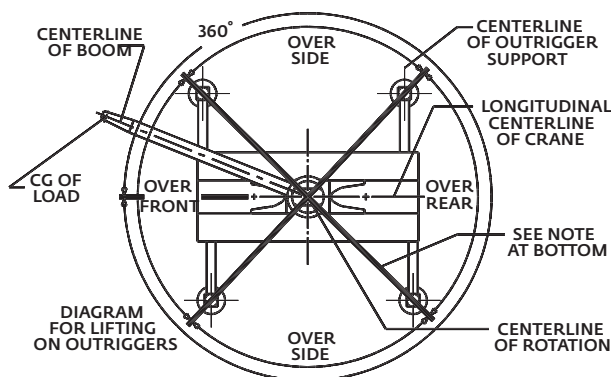

C6-829-003529
C6-829-001159

Bold lines determine the limiting position of any load for operation within working areas indicated.

THIS CHART IS ONLY A GUIDE AND SHOULD NOT BE USED TO OPERATE THE CRANE.

Notes

Notes

Regional headquarters

Manitowoc - Americas

Manitowoc, Wisconsin, USA

Tel: +1 920 684 6621

Fax: +1 920 683 6277

Shady Grove, Pennsylvania, USA

Tel: +1 717 597 8121

Fax: +1 717 597 4062

Manitowoc - Europe, Middle East & Africa

Ecully, France

Tel: +33 (0)4 72 18 20 20

Fax: +33 (0)4 72 18 20 00

Manitowoc - Asia Pacific

Shanghai, China

Tel: +86 21 6457 0066

Fax: +86 21 6457 4955

Regional offices

Americas

Brazil

Alphaville

Mexico

Monterrey

Chile

Santiago

Europe, Middle East & Africa

Algeria

Hydra

Czech Republic

Netvorice

France

Baudemont

Cergy

Decines

Germany

Langenfeld

Hungary

Budapest

Italy

Parabiago

Netherlands

Breda

Poland

Warsaw

Portugal

Baltar

Lisbon

Russia

Moscow

U.A.E.

Dubai

U.K.

Gawcott

Asia - Pacific

Australia

Brisbane

Melbourne

Sydney

China

Beijing

Xi'an

India

Hyderabad

Pune

Korea

Seoul

Philippines

Makati City

Singapore

Factories

Brazil

Alphaville

China

TaiAn

Zhangjiagang

France

Charlieu

La Clayette

Moulins

Germany

Wilhelmshaven

India

Pune

Italy

Niella Tanaro

Portugal

Baltar

Fânzeres

Slovakia

Saris

USA

Manitowoc

Port Washington

Shady Grove

This document is non-contractual. Constant improvement and engineering progress make it necessary that we reserve the right to make specification, equipment, and price changes without notice. Illustrations shown may include optional equipment and accessories and may not include all standard equipment.