









## KENMERKEN / FEATURES / MARKMALE

HL-160 E12	
H (max.)	± 16,00 m
A (max.)	± 14,00 m
C (min.)	2,02 m
DxF (min.)	3,38 x 1,16 m
ExF (max.)	4,88 x 1,16 m
H1	3,18 m
H2	2,43 m
LxB	3,74 x 1,20 m
G	2,67 m
M/N	148 mm/235 mm
∅ D	± 3,92 m
 (max.)	750 kg (2 pers. + 590kg)
 (max.)	750 kg (2 pers. + 590kg)
 (sec.)	70/45 sec.
	2,0 km/h
	0,5 km/h
	22 x 9 x 16
 (max.)	± 25%
	420 Ah/k5/48 V
	7.550 kg

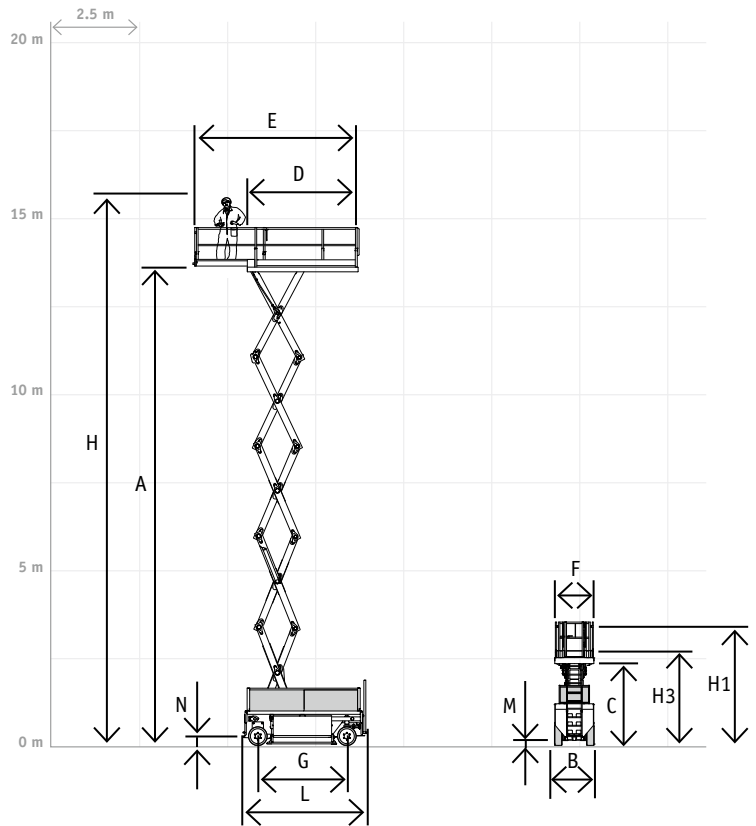

HL-160 E12

## NEDERLANDS

## ENGLISH

## DEUTSCH

## OPTIES

## OPTIONS

## OPTIONEN

Besturing met snelsluitstekker	Controlbox with quick disconnect	Plattformsteuerung mit Schnellstecker	●
Urenteller	Hourmeter	Stundenzähler	●
230V voorziening op platform	230V supply on platform	230V Versorgung an der Plattform	○
Lader (hoogfrequent)	Charger (high frequency)	Ladegerät (Hohfrequenz)	●
Rijden op volle hoogte	Driving at full height	Fahren in voller Höhe	●
Rijden, proportioneel	Driving, proportional	Fahren, proportional	●
Sperfunctie	Differential lock	Differentialsperre	●
Smeersysteem (Easy Lube, Auto Lube)	Lubrication system (Easy Lube, Auto Lube)	Schmiersystem (Easy Lube, Auto Lube)	○

## VEILIGHEIDSVORZIENINGEN

## SAFETY FEATURES

## SICHERHEITSEINRICHTUNGEN

Beschermhek	Scissor skirt	Schutzgitter	--
Daalbeveiliging	Descent safety	Senkschutz	●
Flitslampen	Flashing beacons	Blinkleuchten	○
Rij-alarm (akoestisch)	Drive alarm	Fahrwarnung (akustisch)	●
Nooddaalvoorziening	Emergency descent	Notsenkvorrichtung	●

## TOEPASSING

















## APPLICATION

## ANWENDUNG

Voor gebruik in gesloten ruimten	Indoors	In geschlossenen Räumen	●
Voor gebruik buiten	Outdoors	Im Freien	--
Toelaatbare min. omgevingstemperatuur	Certified min. temperature	Zul. Tiefsttemperatur	-15°C

# Conversion table

TYPE	NEW CODE	WORKING HEIGHT (m)	MAX LOAD CAPACITY (kg)	PLATFORM (m)	TOTAL WEIGHT (kg)	SPECIFICATION
Z-45EL8	HL-65 E8	6,50	220	2,21 × 0,77	1.065	Electric
Y-64EL8	HL-84 E8	8,40	350	3,55 × 0,84	1.860	Electric
Y-64EL14	HL-84 E14	8,40	300	3,55 × 1,34	2.320	Electric
Y-70DL12-TR	HL-90 T12	9,00	500	4,10 × 1,16	3.650	Diesel, Track
XZ-65DXL22-TR	HL-90 TX22	8,50	750	5,90 × 1,95	6.540	Diesel, Track
HL-7810	HL-100 E10	9,90	450	3,24 × 0,98	2.380	Electric, Fold down railing
HL-7814	HL-100 E14	9,90	450	3,34 × 1,20	2.440	Electric, Fold down railing
Y-83EL12	HL-103 E12	10,30	350	3,55 × 1,14	2.320	Electric
Y-83EL16	HL-103 E16	10,30	350	3,55 × 1,55	2.760	Electric
X-Z85DL22-TR	HL-110 T22	10,60	750	4,61 × 2,00	6.720	Diesel, Track, Fold down railing
HL-9710	HL-120 E10	11,70	325	3,24 × 0,98	2.510	Electric, Fold down railing
HL-9714	HL-120 E14	11,70	325	3,24 × 1,20	2.740	Electric, Fold down railing
X-105EL12	HL-130 E12	12,70	650	5,05 × 1,17	4.780	Electric, Fold down railing
X-105EL16	HL-130 E16	12,70	650	5,05 × 1,56	4.920	Electric, Fold down railing
X-105EL18	HL-130 E18	12,80	650	5,05 × 1,56	4.980	Electric, Fold down railing
X-105DL22-TR	HL-130 T22	12,80	500	4,61 × 1,74	7.020	Diesel, Track, Fold down railing
HL-11812	HL-140 E12	13,80	300	2,34 × 1,20	3.200	Electric, Fold down railing
HL-11816	HL-140 E16	13,80	300	2,34 × 1,40	3.260	Electric, Fold down railing
N-140EL12	HL-160 E12	16,00	750	4,88 × 1,16	7.550	Electric, Fold down railing
Q-135EL18	HL-160 E18	15,50	750	6,06 × 1,78	7.280	Electric, Fold down railing
Q-135EL24	HL-160 E24	15,50	750	6,06 × 2,30	7.480	Electric, Fold down railing
Q-135DL24 4WD/P/N	HL-160 D24 4WD/P/N	15,70	750	6,06 × 2,30	8.710	Diesel, Fold down railing, 4WD/P/N
Q-135DL24-TR	HL-160 T24	16,00	750	6,06 × 2,30	10.400	Diesel, Track, Fold down railing
N-165EL12	HL-190 E12	18,50	500	4,88 × 1,16	7.985	Electric, Fold down railing
B-165EL25	HL-190 E25	18,50	1000	7,00 × 2,30	9.980	Electric, Fold down railing
B-165DL25 4WD/P/N	HL-190 D25 4WD/P/N	18,50	1000	7,00 × 2,30	11.390	Diesel, Fold down railing, 4WD/P/N
N-195EL12	HL-220 E12	21,70	500	4,88 × 1,16	9.120	Electric, Fold down railing
B-195EL25	HL-220 E25	21,70	750	7,00 × 2,30	11.670	Electric, Fold down railing
B-195DL25 4WD/P/N	HL-220 D25 4WD/P/N	21,70	750	7,00 × 2,30	11.990	Diesel, Fold down railing, 4WD/P/N
B-195HYL25 4WD/P/N	HL-220 H25 4WD/P/N	21,70	750	7,00 × 2,30	13.500	Hybrid, Fold down railing, 4WD/P/N
T-210DL25 4WD/P/N	HL-235 D25 4WD/P/N	23,20	1000	7,32 × 2,40	17.950	Diesel, Fold down railing, 4WD/P/N
M-250EL25 4WD/P/N	HL-275 E25 4WD/P/N	27,50	1000	8,25 × 2,50	23.980	Electric, Fold down railing, 4WD/P/N
M-250DL27 4WD/P/N	HL-275 D27 4WD/P/N	27,50	1000	8,25 × 2,50	21.910	Diesel, Fold down railing, 4WD/P/N
M-250HYL25 4WD/P/N	HL-275 H25 4WD/P/N	27,50	1000	8,25 × 2,35	24.980	Hybrid, Fold down railing, 4WD/P/N
N-265EL13 4WDS	HL-285 E13 4WDS	28,20	750	7,41 × 1,30	18.770	Electric, Fold down railing, 4WDS
N-265EL13 4WDS/N	HL-285 E13 4WDS/N	28,20	750	7,41 × 1,30	19.370	Electric, Fold down railing, 4WDS/N
N-310EL14 4WDS/N	HL-330 E14 4WDS/N	33,00	600	8,40 × 1,20	24.000	Electric, Fold down railing, 4WDS/N
G-320EL30 4WDS/N	HL-340 E30 4WDS/N	33,70	1000	9,66 × 2,80	34.850	Electric, Fold down railing, 4WDS/N
G-320DL30 4WDS/N	HL-340 D30 4WDS/N	33,70	1000	9,66 × 2,80	31.200	Diesel, Fold down railing, 4WDS/N

H (max.)	Werkhoogte Working height Arbeitshöhe
H* (max.)	Werkhoogte (op stempels) Working height (on outriggers) Arbeitshöhe (auf Stützen)
A (max.)	Max. platformhoogte Max. platform height Max. Plattformhöhe
C (min.)	Min. platformhoogte Min. platform height Min. Plattformhöhe
DxF (min.)	Platform afmetingen (ingeschoven) Platform dimensions (retracted) Plattformgröße (eingeschoben)
ExF (max.)	Platform afmetingen (uitgeschoven) Platform dimensions (extended) Plattformgröße (ausgeschoben)
H1	Transporthoogte Transport height Transporthöhe
H2	Transporthoogte (leuning verwijderd) Transport height (handrail removed) Transporthöhe (Geländer entfernt)
H3	Transporthoogte (leuning neergeklapt) Transport height (handrail folded down) Transporthöhe (Geländer umgeklappt)
LxB	Transportafmetingen Transport dimensions Transportabmessungen
G	Wielbasis Wheel base Radstand
K	Trackbreedte Track width Raupenbreite
M/N	Bodemvrijheid Ground clearance Bodenfreiheit
∅ D	Draaistraal uitwendig Turning radius outside Wenderadius Außen
∅ R	Draaistraal inwendig Turning radius inside Wenderadius Innen
 (max.)	Max. belasting platform (ingeschoven) Capacity main platform Tragfähigkeit Plattformfestteil
 (max.)	Max. belasting platform (uitgeschoven) Capacity roll-out deck Tragfähigkeit Plattformausschub
 (sec.)	Hef-/daaltijd (max. last) Lift-/lower time (max. load) Hebe-/Senkzeit (max. Traglast)
	Rijsnelheid (snel) Driving speed (high) Fahrgeschwindigkeit (schnell)
	Rijsnelheid (langzaam) Driving speed (slow) Fahrgeschwindigkeit (langsam)
	Banden, non marking (volrubber) Tyres, non marking (solid rubber) Reifen, non marking (Vollgummi)
	Banden, terrein (schuimgevuld) Tyres, terrain (foamfilled) Reifen, Gelände (ausgeschäumt)
	Banden, tractor (schuimgevuld) Tyres, tractor (foamfilled) Reifen, Traktor (ausgeschäumt)
	Vlakstellen links/rechts (dwars) Levelling left/right (transversal) Quernivellierung (links/rechts)
 (max.)	Max. klimvermogen Gradeability Max. Steigfähigkeit
	Batterijcapaciteit (natte cellen) Batteries (traction acid) Batteriekapazität (Traktion Naßzellen)
	Dieselmotor Diesel engine Dieselmotor
	Hybride Hybrid Hybrid
 <b>KG</b>	Eigengewicht Gross weight Eigengewicht
	Standaard Standard Standardausrüstung
	Optie Option Option
--	Niet beschikbaar Not available Nicht verfügbar