



MOBILE CONE CRUSHERS

# MOBICONE



# COMPETENCE AS TRADITION

KLEEMANN is part of the WIRTGEN GROUP, a group of companies in the plant construction industry who operate on an international level. This Group includes the five well-known brands, WIRTGEN, VÖGELE, HAMM, KLEEMANN and BENNINGHOVEN, with their headquarters in Germany and local production sites in Brazil, India and China. Customer service is provided worldwide through its 55 independent sales and service outlets.



## 04

### ABOUT KLEEMANN

04 Competence  
06 Portfolio

## 08

### MOBICONE - THE SERIES

## 10

### EVO-LINE

10 Advantages at a glance  
12 MCO 9/MCO 9 S EVO

## 20

### QUARRY-LINE

20 Advantages at a glance  
22 MCO 11 PRO  
24 MCO 11 S  
26 MCO 13/13 S



28

**TECHNICAL EXPERTISE**

30

**THE KLEEMANN  
SERVICE PROGRAM**

32

**SPARE PARTS**

34

**FEATURES**

# KLEEMANN: KNOW-HOW, INNOVATION, QUALITY

For the past 100 years, KLEEMANN GmbH has been developing and manufacturing machines and plants for the natural stone and recycling industry.



**WIRTTGEN  
GROUP**

Through the WIRTGEN GROUP, KLEEMANN can offer service and support throughout the world. Optimum customer care and performance and availability of the plants are thus guaranteed at all times.





As an innovative manufacturer of mobile crushing and screening plants, KLEEMANN impresses with high quality, state-of-the-art technologies and superior application know-how.



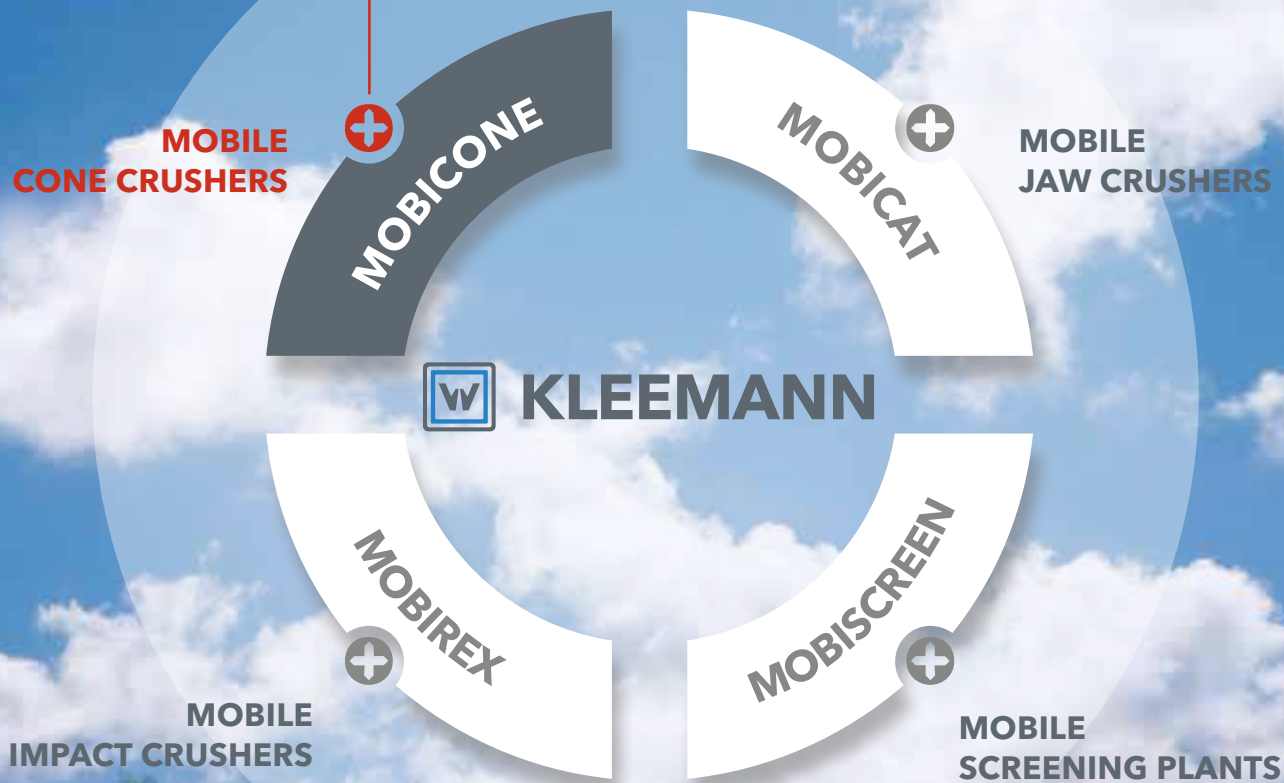



## MOBICONE MOBILE CONE CRUSHERS



- For recrushing in the 2nd and 3rd crushing stage

### USE IN:

- > medium-hard to hard, abrasive natural stone
- > mining applications



## MOBICAT MOBILE JAW CRUSHERS



- For coarse and pre-crushing

### USE IN:

- > medium-hard to hard natural stone
- > recycling
- > mining applications



## MOBIREX MOBILE IMPACT CRUSHERS



- For high crushing rates and high quality end product with cubic grain shape in the 1st and 2nd crushing stage

### USE IN:

- > soft to medium-hard natural stone
- > recycling



## MOBISCREEN MOBILE SCREENING PLANTS



- Screens for process or coarse elements

### USE IN:

- > all natural stones
- > residual construction materials
- > iron



## MOBIFOX MOBILE IMPACT CRUSHERS

- For recrushing in the 2nd and 3rd crushing stage

### USE IN:

- > moderate abrasive natural stone

# MOBICONE – THE MOBILE CONE CRUSHERS FROM KLEEMANN

The mobile cone crushers of the MOBICONE series are employed in medium hard to hard as well as abrasive natural stone and in mining applications. The cone crushers return very good cubic results in the 2nd and 3rd crushing stage. The MOBICONE plant systems are available in different sizes, versions and for different applications. The cone crushers are well suited, above all, for linking primary crushers and screening plant systems.





## APPLICATION OF THE MOBICONE PLANTS

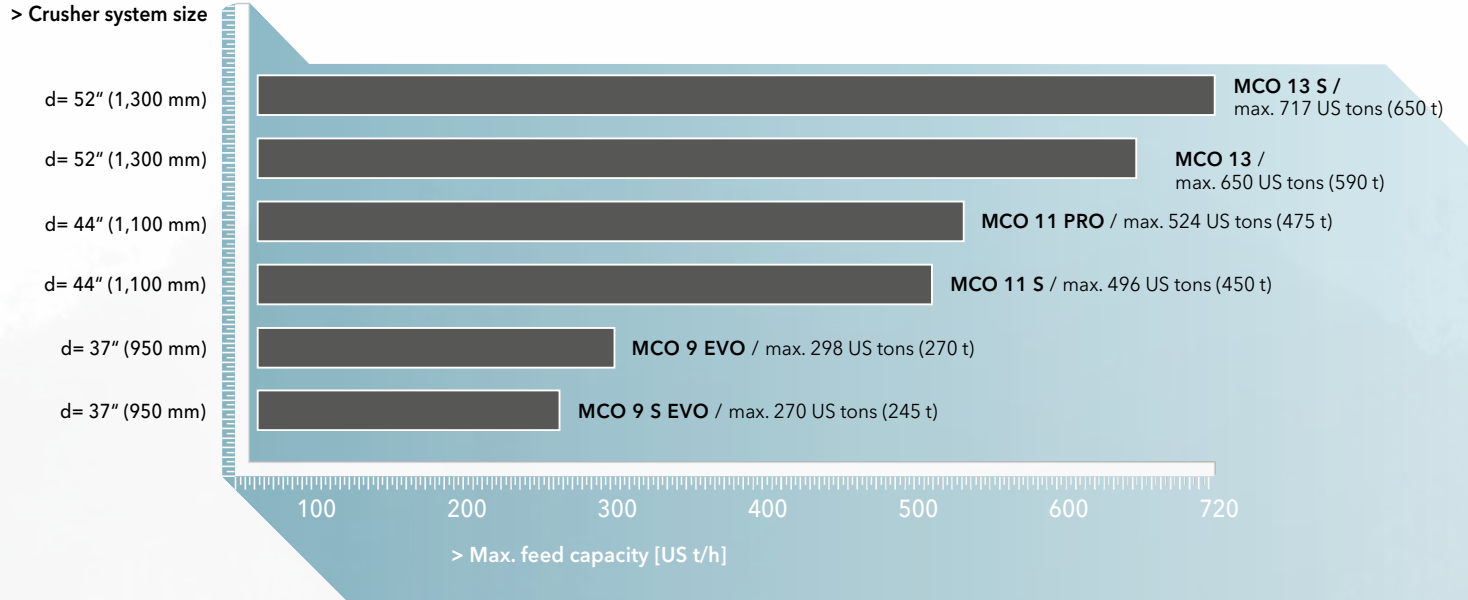

# MOBILE CONE CRUSHER MOBICONE EVO-LINE THE POWERFUL COMPACT CLASS

**Large material dumps** and simple material transfer to a downstream machine thanks to the large discharge height: wide and sturdy crusher discharge conveyor

**Frugal consumption:** Efficient and powerful diesel-direct drive with fluid coupling for protection of the plant

**High performance screening plant** with extra-large screening surface (MCO 9 S EVO)



**Simple, user-friendly operation** and fast diagnosis in the event of a fault: Modern control concept with menu-guided touch panel

## YOUR ADVANTAGES AT A GLANCE

**Agile and compact during transport and operation. Can be deployed flexibly with primary crushers and screening plant systems.**

The MOBICONE EVO-Line plant systems can be deployed in numerous ways: in medium hard to hard as well as abrasive natural stone, they produce very good final product quality and achieve high feed capacities. The plant systems are relatively light, easy to transport and equipped with a drive concept that takes account of the changing operating conditions. They are designed especially for the second and third crushing stage and can be operated particularly cost effectively.

➤ **Application in natural stone**



**High productivity:** Optimal crusher feed by innovative CFS load control (Continuous Feed System)



**High crushing capacity and plant protection:** Cone crusher with large lift and integrated overload system

**Fast tooling time** and easy adaptation of material discharge pattern thanks to pushing mechanism



- **Optimum process:** Outstanding linkage options with other KLEEMANN plant systems owing to electric drive
- **Productivity:** Realistic feed capacity of up to 298 US t/h (270 t/h)
- **Availability:** Plain machine design for good service accessibility



# MOBICONE MCO 9/MCO 9 S EVO

## THE EFFICIENT BUNDLE OF POWER

The mobile cone crushers of the EVO-Line are compact but powerful plant systems and produce a very good final product quality. They are available in two versions: "basic version" MCO 9 and S version MCO 9 S, which can also be equipped with a secondary screening unit.



### THE KLEEMANN APPLICATION RECOMMENDATION

- Secondary and tertiary crushers of medium hard to hard as well as abrasive natural stone
- Feed capacity of up to 298 US tons (270 tons) per hour
- For low to medium hourly output
- For changing deployment sites thanks to ease of transportation
- For a complete process: Can be combined with jaw crushers of the MOBICAT EVO-Line and screening plant systems of the MOBISCREEN series

### APPLICATION



In medium hard to hard natural stone

# MOBICONE EVO



Compact, short setup times, can be networked flexibly: MCO 9 EVO.

## TRANSPORT



Low weight and compact dimensions, easy to transport with low-loader

### Technical information MCO 9/MCO 9 S EVO

<b>Feed capacity up to approx.</b>	298/270 <sup>1)</sup> US t/h (270/245 <sup>1)</sup> t/h)
<b>Crusher system size</b>	d = 37" (950 mm)
<b>Feed size up to max.</b>	8" (200 mm)
<b>Weight</b>	68,350 lbs./90,950 <sup>2)</sup> lbs 31,000/41,250 <sup>2)</sup> kg)

<sup>1)</sup>In closed loop <sup>2)</sup>With secondary screening unit

# ONE CONCEPT - TWO VERSIONS

The mobile MOBICONE MCO 9/9 S EVO cone crushers from KLEEMANN are available in two versions and are characterized by their versatility, high machine availability and ease of transport.



+

MOBICONE MCO 9 - High throughput, compact dimensions.

## MOBICONE MCO 9 EVO

The MOBICONE MCO 9 has compact dimensions and is easy to transport owing to a weight of 34 US tons (31 tons). Thanks to the simple setup, it does not take much to assemble and get it ready for operation.

Powerful and compact, the plant system also scores in terms of diesel consumption: The direct crusher drive as well as the electric drive systems of the conveyor belts ensure that the fuel consumption is kept at a satisfyingly

low level. The MCO 9 EVO also has high electrical energy reserves that are sufficient to supply an external conveyor belt as well. The extended crusher discharge conveyor, which is available as an option, can be hydraulically folded as standard and ensures a high heap volume. With the optional external oversize grain conveyor, a closed loop can be created in collaboration with a MOBISCREEN screening plant.

# MOBICONE EVO



MOBICONE MCO 9 S with single deck vibrating screen - for production of a defined final grain size.

## MOBICONE MCO 9 S EVO

Compared with the MCO 9, the MOBICONE MCO 9 S is equipped with a more powerful drive unit and a larger chassis.

As an option, it also has a secondary screening unit (single deck vibrating screen) with return conveyor. This permits a closed material loop and thus the production of a defined final grain size - with just one machine!

Optionally, the oversize grain can also be discharged up to 100° to the side via the swivel-mounted return conveyor. The secondary screening unit can be removed easily - facilitating compact container dimensions (less than 10' (3 m) wide) and thereby trouble-free transport per hooklift system.

# CRUSHER UNIT - WITH LARGE LIFT FOR HIGHEST CRUSHING CAPACITY

The cone crusher of the MOBICONE MCO 9/9 S EVO plant systems features a large lift and a sturdy crusher design. In combination with the powerful drive, a high crushing ratio is therefore possible. The integrated overload system protects the plant against unbreakable material through automatic lifting of the crusher upper frame - for longer service life of the machine and less

wear of the crushing tools. Fast tool change completely without sealing compound, which means that it is independent of the outside temperature, also supports greater productivity. The crusher gap adjustment (even during active operation) and zero point calculation are carried out simply via the touchpanel from ground level. This dispenses with tooling times.

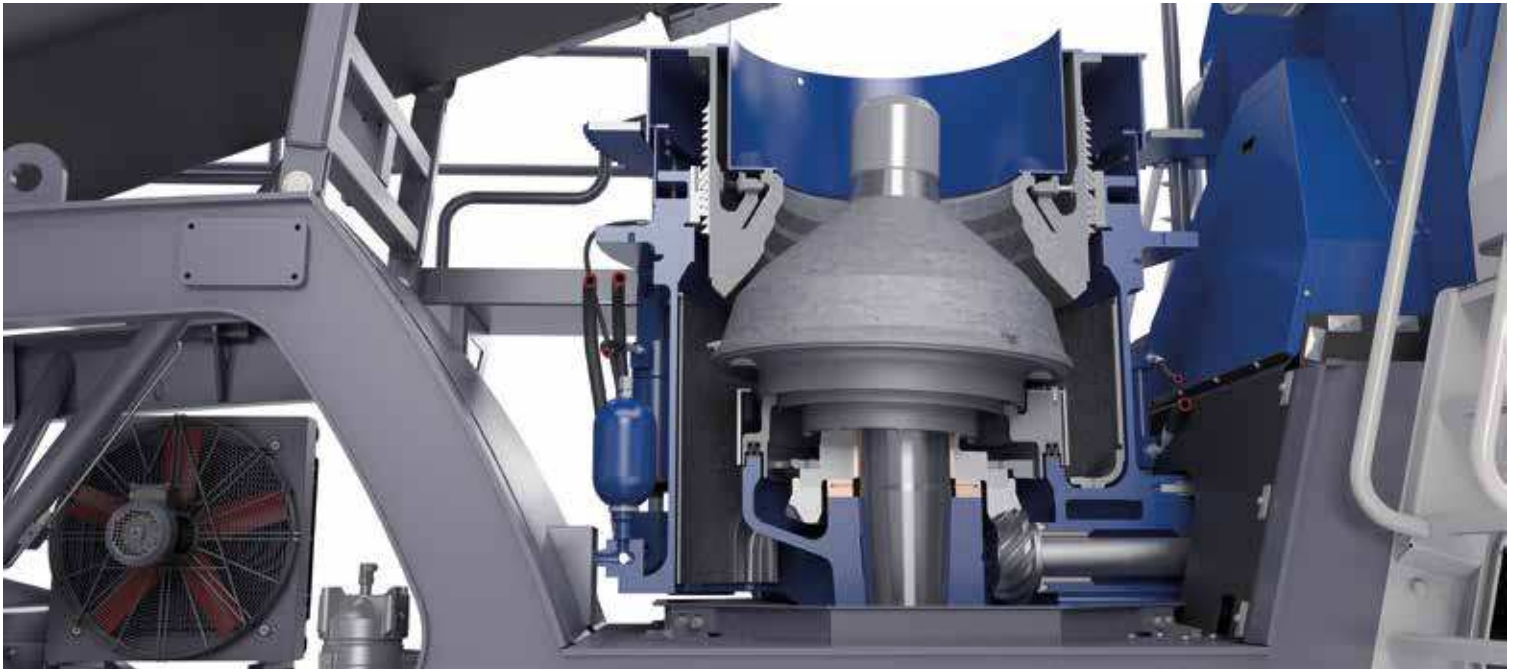

# FRUGAL CONSUMPTION AND HIGH OPERATIONAL SAFETY

The MOBICONE MCO 9/9 S EVO plant systems are distinguished by the innovative "diesel-direct-electric" drive concept. The crusher's powerful direct drive is extremely efficient and proves fruitful with very low consumption values. The fluid coupling guarantees high operational reliability and protection for the machine. All other components are powered by a high performing onboard generator. Unlike hydraulic drive systems, dips in power are not experienced at all.

Since the travel drive is activated with the aid of a magnetic clutch, an additional electric motor can be dispensed with. This makes the plant system not only more compact but also more economic in terms of overall energy consumption.





# MOBICONE EVO



**Daniel Speisser**  
Manager Customer Support Training

## The team player for tough tasks

The MCO 9 EVO shines in hard stone with high performance values and low consumption. Moreover, it impresses as an exemplary team player: in combination with the MC 110 Z EVO jaw crusher, the automatically adapted, line-coupled material flow concept assures optimum throughput.



# REALLY GOOD IN COMBINATION

END SCREENING STAGE



3RD CRUSHING STAGE



As linked plant combinations, the MOBICONE MCO 9/9 S EVO cone crushers really play out their strengths. The electric drives enable very good material flow control across all crushing and screening stages:

- Control of primary crusher conveying speed depending on fill level of cone crusher in next crushing stage
- Conveyor elements remain operationally ready at all times (no complete standstill) and begin conveying again as soon as the crusher is free
- Emergency-off control across all crushing and screening stages
- Transfer heights to match other KLEEMANN plant systems



**1ST CRUSHING STAGE**

**2ND CRUSHING STAGE**

**INTERMEDIATE SCREENING STAGE**

# MOBILE CONE CRUSHER MOBICONE QUARRY-LINE FOR TOUGHER TASKS

**Powerful, benefiting from flexible deployment:**

Diesel-electric drive concept with the option of external power supply

**Generous feeding unit:** Hopper made from wear-resistant steel, with replaceable wear lining as an option

**High crushing capacity:** Cone crusher with large lift for highest crushing capacity



● **Easy transportation** thanks to hydraulically folding belts and pushing mechanism

● **Safe and ergonomic:** Fast and convenient service thanks to optimum accessibility of all components

## YOUR ADVANTAGES AT A GLANCE

**The Quarry-Line from KLEEMANN - robust and powerful.**

The Quarry-Line plant systems impress with their very strong performance and a particularly hard wearing design - which makes them the perfect solution for non-stop quarrying operations. Thanks to a generously dimensioned crusher inlet, it is also possible for large volumes of material to be processed quickly and efficiently.

➤ **Use in natural stone and mining**



**High productivity:** Optimum crusher level thanks to Continuous Feed System (CFS)

**For large discharge heights:**  
Wide and sturdy crusher discharge conveyor, can also be extended as an option



**Easy to use without tooling times:**  
Convenient, automatic gap setting via touchpanel



**Simple and self-explanatory:**  
Clearly structured machine control system with intuitive control concept



# MOBICONE MCO 11 PRO

## THE NEW POWER PACK



High throughput, very sturdy design, dual power capable: MOBICONE MCO 11 PRO.

### THE KLEEMANN APPLICATION RECOMMENDATION

- Secondary and tertiary crushing
  - > From medium-hard to hard abrasive natural stone
  - > In mining applications
- Feed capacity up to 518 US tons (470 tons) per hour
- For large batch sizes
- For a complete process: Can be combined with jaw crushers of the MOBICAT Quarry-Line and screening plant systems of the MOBISCREEN series

### APPLICATION

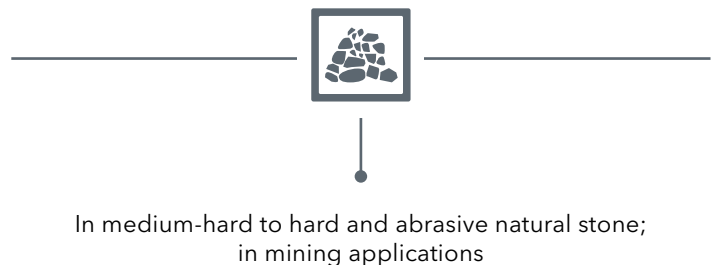

# MOBICONE PRO



The MOBICONE MCO 11 PRO impresses with a completely new system design boasting numerous features that have already proven themselves in the EVO-Line and have been further developed for the "Quarry" area. Technical highlights such as the innovative Continuous Feed System or the fully automatic crusher gap adjustment are therefore also available for large batch sizes in quarrying and mining applications for the first time.

## EASY TO OPERATE

Another bonus of the MCO 11 PRO is the control concept SPECTIVE. The menu-guided user interface makes the machine easy and intuitive to operate. The self-explanatory graphic display actively supports the user during operation and simplifies fault finding.

## SPECTIVE

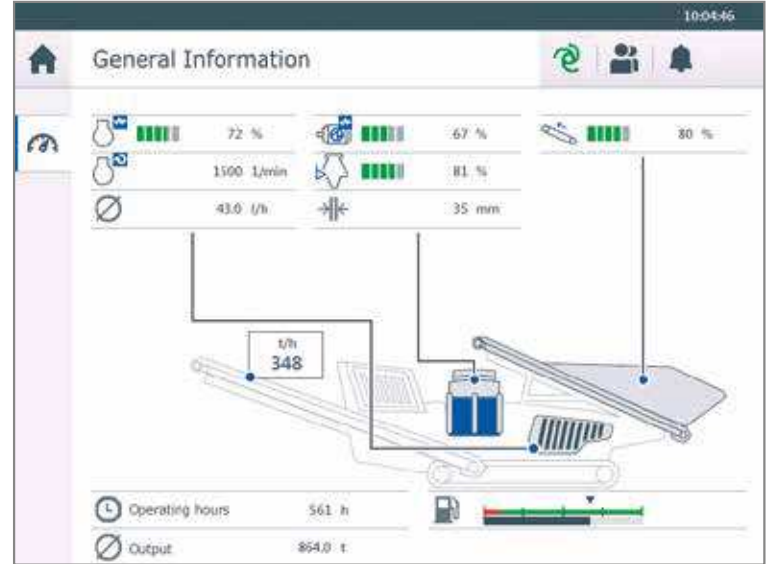

### ROBUST CRUSHER



Sturdy KX 350 cone crusher

### Technical information MCO 11 PRO

<b>Feed capacity up to approx.</b>	518 US t/h (470 t/h)
<b>Crusher system size</b>	d = 44" (1,100 mm)
<b>Max. feed size</b>	9.4" (240 mm)
<b>Weight</b>	110,230 lbs (50,000 kg)

# MOBICONE MCO 11 S

## THE CLASSIC WITHOUT COMPROMISE



Sturdy and operationally safe - the MCO 11 S with powerful triple-deck screening unit.

### THE KLEEMANN APPLICATION RECOMMENDATION

- Secondary and tertiary crushing
  - > From medium-hard to hard as well as abrasive natural stone
  - > In mining applications
- Feed capacity up to 496 US tons (450 tons) per hour
- For large batch sizes
- For a complete process: Can be combined with jaw crushers of the MOBICAT Quarry-Line and screening plant systems of the MOBISCREEN series

### APPLICATION



In medium-hard to hard abrasive natural stone; in mining applications





The MCO 11 S mobile cone crushing system is a quarry classic. Efficient and powerful, it impresses with the benefits of being a sturdy crusher, its diesel-electric drive as well as optional connection to an external current source. Equipped with a tough and high performing triple-deck screening unit, a closed loop is possible. In this way, up to three defined final grain sizes can be produced.

## OPTIMUM LINKING

The MCO 11 S can be used optimally in a multi-staged crushing process: as a secondary or tertiary crusher in conjunction with primary crushers of the MOBICAT series and MOBISCREEN screening plant. In this way, mobile production of high quality final grain sizes is made possible.



### ROBUST CRUSHER



Sturdy KX 300 cone crusher

### Technical information MCO 11 S

<b>Feed capacity up to approx.</b>	496 US t/h (450 t/h)
<b>Crusher system size</b>	d = 44" (1,100 mm)
<b>Max. feed size</b>	8" <sup>1)</sup> (200 <sup>1)</sup> mm)
<b>Screen size (W x L)</b>	6' 9" x 16' 5" (2,050 x 5,000 mm)
<b>Weight</b>	165,350 lbs (75,000 kg)

<sup>1)</sup> To upstream classifying screen

# MOBICONE MCO 13/MCO 13 S

## THE STRONG PERFORMER

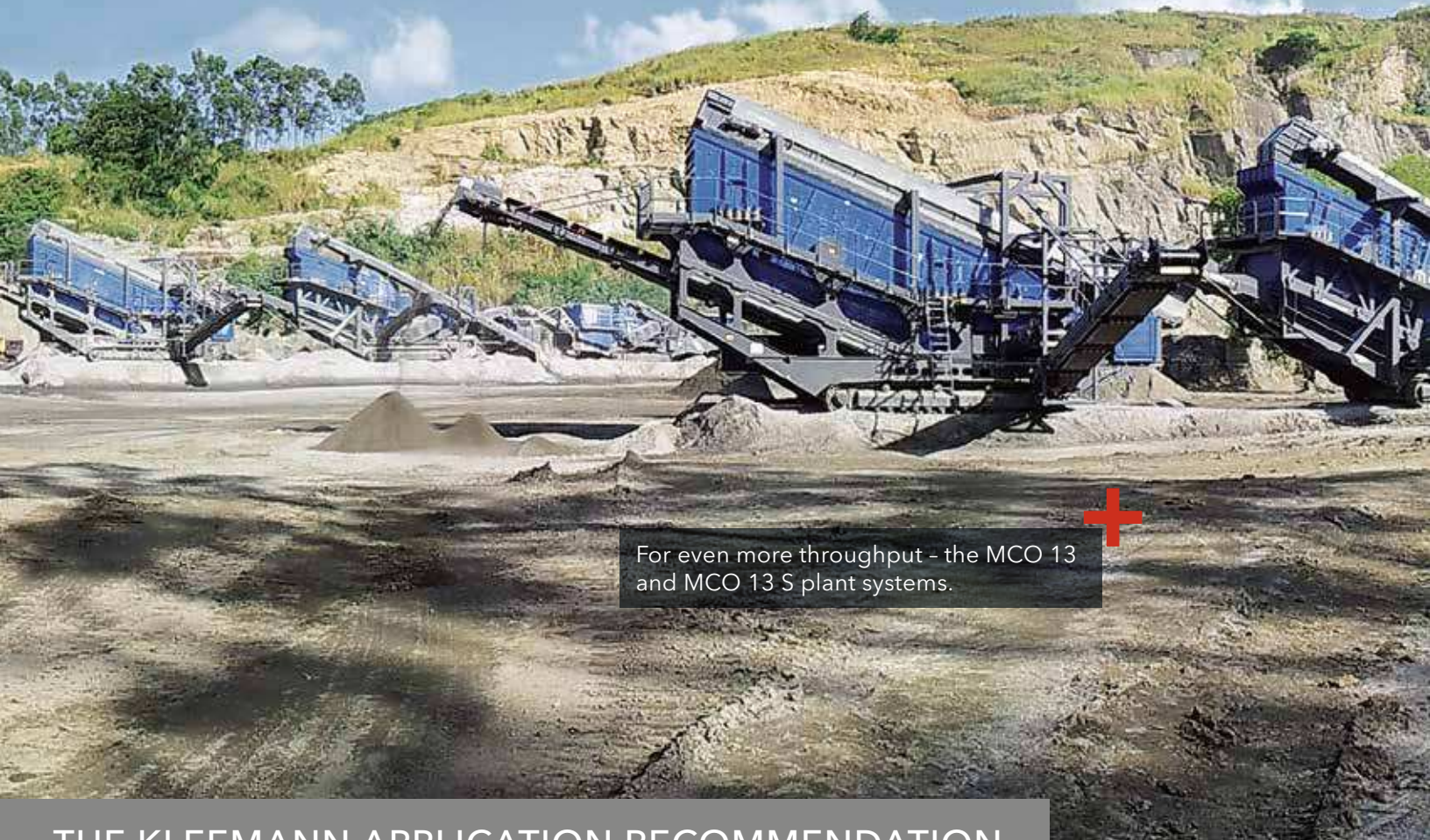

For even more throughput - the MCO 13 and MCO 13 S plant systems.

### THE KLEEMANN APPLICATION RECOMMENDATION

- Secondary and tertiary crushing
  - > From medium-hard to hard abrasive natural stone
  - > In mining applications
- Feed capacity up to 717 US tons (650 tons) per hour
- For very long hourly outputs
- For a complete process: Can be combined with jaw crushers of the MOBICAT Quarry-Line and screening plant systems of the MOBISCREEN series

### APPLICATION



In medium-hard to hard abrasive natural stone;  
in mining applications



The mobile MOBICONE MCO 13/13 S cone crushers are available in two versions. The MCO 13 can process maximum feed sizes of up to 13" (330 mm).

## SCREENING WITHOUT COMPROMISE

The MOBICONE MCO 13 S is fitted with a sturdy triple-deck screening unit. At 7' 9" x 19' 8" (2,350 x 6,000 mm) the dimensions are generous, meaning that even large material volumes can be screened without trouble.



### ROBUST CRUSHER



Sturdy KX 400 cone crusher

#### Technical information MCO 13/ MCO 13 S

<b>Feed capacity up to approx.</b>	650/717 <sup>1)</sup> US t/h (590/650 <sup>1)</sup> t/h
<b>Crusher system size</b>	d = 52" (1,300 mm)
<b>Max. feed size</b>	13"/11" <sup>2)</sup> (330/280 <sup>2)</sup> mm)
<b>Screen size (W x L)<sup>3)</sup></b>	7' 9" x 19' 8" (2,350 x 6,000 mm)
<b>Weight</b>	165,350/253,530 lbs 75,000/115,000 kg

<sup>1)</sup> In closed loop <sup>2)</sup> To upstream screen <sup>3)</sup> Only MCO 13 S

# IDEALLY COMBINED – INTERLINKED PLANTS

Because quarrying approval is usually time-limited and due to the demands placed on plants during quarrying operations, mobile combinations of plants are now being used increasingly. Thanks to modern technology, such plants can achieve the same quality of final grain size. The reductions in transport costs that are possible also make them a very cost-effective solution.



## TECHNICAL EXPERTISE

KLEEMANN, due to its experience, has the expertise necessary for the design and manufacture of complex mobile processing plants. A complete portfolio is available for implementing the different processes and applications.



## THE KLEEMANN SERVICE PROGRAM:

# CUSTOMER SERVICE AT KLEEMANN

Customer service at KLEEMANN means: reduced downtimes, minimum wear costs, maximum customer proximity.

A wide range of training courses as a basis for optimal use of our plants. A dense network with experienced service technicians. Quickly available original spare parts. All of this is guaranteed by our comprehensive support organization. Worldwide, day after day.

### The KLEEMANN service program:

- Professional maintenance and repair of your machines and plants
- Preventive maintenance through service contracts
- Ordering of original parts - the correct wear part for your application, reduction in wear part and operating costs
- Application advice and training





## SERVICE NETWORK



Our local contact partners provide you with comprehensive support for all tasks and questions related to our products. Quick technical support is our main priority. We ensure short response times and quick solutions through a close network of subsidiaries, their experienced service technicians and the additional support provided by our support organization in the parent plant.

## TRAINING COURSES



An essential element of the successful use of our plants is corresponding knowledge of their operation. In order to communicate the necessary technical knowledge to your employees, KLEEMANN offers a wide range of training courses, which can be carried out in the CTT (Center for Training and Technology) or on site.

## PARTS AND ACCESSORIES



Original parts and accessories from KLEEMANN can assure the high reliability and availability of the machines in the long term. Rapid identification of the correct part is possible using WIDOS - the WIRTGEN GROUP documentation system. An overview of all spare parts with simple ordering information is available under [www.partsandmore.net](http://www.partsandmore.net)

Further information: [service@kleemann.info](mailto:service@kleemann.info)

*Courtesy of Machine.Market*

# CRUSHING TECHNOLOGY - FOR OPTIMUM RESULTS



## Optimum crushing result

The cone crushers in the KX series are generally used as secondary and tertiary crushers.

The eccentric rotating around the main shaft is powered by the reduction gear. The rotation sets the head into a tumbling motion, whereby the crushing gap opens and closes cyclically.

The grain size of the final product can be modified by adjusting the crushing gap (Open Side Setting OSS = open gap width / Closed Side Setting CSS = closed gap width).

The entire wear surface is used with the correct combination of crushing gap and crushing tool - the plant works more efficiently and the operating life increases.

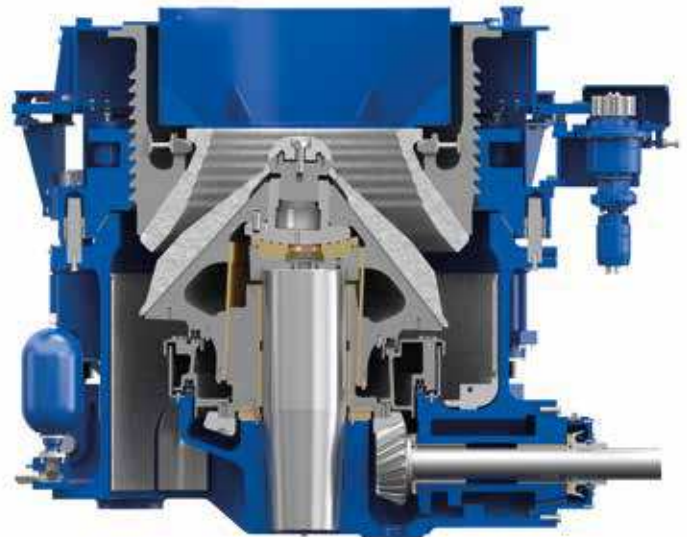

Integrated overload system for protection in the case of uncrushable materials such as wood or metal („Tramp Release System“)



## > OVERVIEW CRUSHING TOOLS

Standard Coarse (SC)

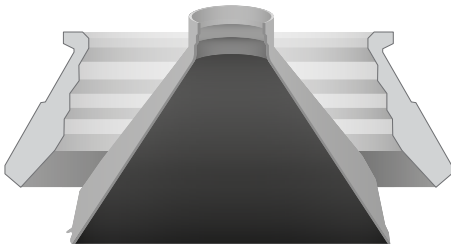

Standard Medium (SM)

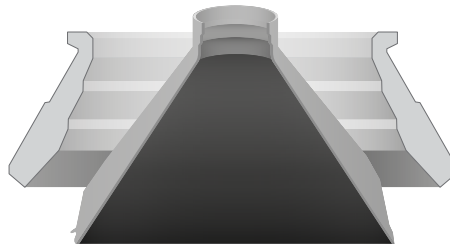

Standard Fine (SF)

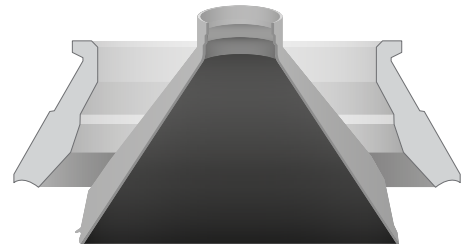

Short Head Coarse (SHC)

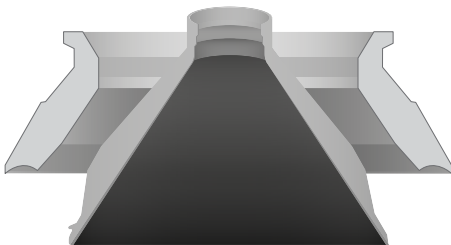

Short Head Medium (SHM)

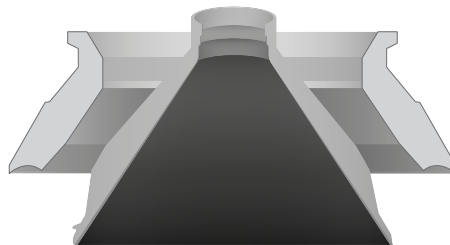

Short Head Fine (SHF)

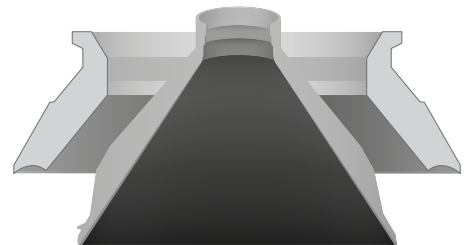

### All down to the right combination

To achieve a constant high output and long service life, the whole wear surface of the crushing tool has to be used.



This is only possible if the crushing tool can be selected in the right relation to the size of feed material and the desired end product. If, for example, a crushing tool is used with fine feed material for coarse crushing, the crushing process is only concentrated on the lower part of the crushing tool, while the upper part is barely used.

This results in premature replacement of the crushing tools. With the right combination of crushing chamber and crushing tool, the whole wear surface is used - the plant works more effectively and the service life is longer

A well-balanced combination achieves the following:



- Even wear
- Good utilisation of crushing tools
- Good end product
- Continued capacity utilisation of plant
- Low energy consumption



	EVO-LINE	
	MCO 9 EVO	MCO 9 S EVO
		
Feed size up to max. (depending on material)	8" (200 mm)	8" (200 mm)
Crusher system size d=	37" (950 mm)	37" (950 mm)
Feed capacity up to approx.	298 US t/h (270 t/h)	270 US t/h (245 t/h) <sup>1)</sup>
Weight approx.	68,350 lbs (31,000 kg)	90,950 lbs (41,250 kg) <sup>2)</sup>
Drive concept	diesel-direct-electric	
Features	simple control, menu-guided touch panel	
	Continuous Feed System (CFS)	
	fully automatic crushing gap setting	
	hydraulic folding crusher discharge conveyor	
	pushing mechanism of feeding unit	
	optional oversize grain returning with external screening plant	secondary screening unit with return conveyor (optional)
Application spectrum	Natural stone	Natural stone

<sup>1)</sup> Closed loop <sup>2)</sup> inc. secondary screening unit

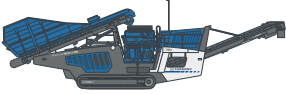
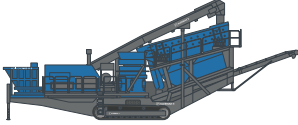
QUARRY-LINE

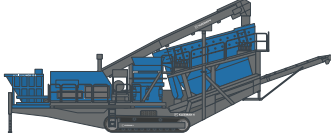
MCO 11 PRO	MCO 11 S	MCO 13	MCO 13 S
			
9.4" (240 mm)	8" (200 mm)	13" (330 mm)	11" (280 mm)
44" (1,100 mm)	44" (1,100 mm)	52" (1,300 mm)	52" (1,300 mm)
518 US t/h (470 t/h)	496 US t/h (450 t/h) <sup>1)</sup>	650 US t/h (590 t/h)	717 US t/h (650 t/h)
110,230 lbs (50,000 kg)	165,350 lbs (75,000 kg)	165,350 lbs (75,000 kg)	253,530 lbs (115,000 kg)
diesel-electric, connection to external power supply possible (optional)			
simple control, menu-guided touch panel	electrical control with plain text display	electrical control with plain text display	electrical control with plain text display
Continuous Feed System (CFS)			
fully automatic crushing gap setting	hydraulically assisted crusher gap adjustment	hydraulically assisted crusher gap adjustment	hydraulically assisted crusher gap adjustment
hydraulic folding crusher discharge conveyor			
pushing mechanism of feeding unit			
Natural stone Mining	Natural stone Mining	Natural stone Mining	Natural stone Mining



# KLEEMANN



## WIRTGEN AMERICA

6030 Dana Way · Antioch, TN 37013

Phone: (615) 501-0600 · Fax: (615) 501-0691

✉ [www.wirtgen-group.com/america](http://www.wirtgen-group.com/america)