

KOBELCO

HYDRAULIC CRAWLER CRANE **CK2500**

WITH OPTIONAL JIB





SPECIFICATIONS FOR CK2500 CRAWLER CRANE

The Kobelco CK2500 Crawler Crane is designed from the ground up for reliable operation, convenient maintenance and easy transport. Please consult your Kobelco distributor for additional information regarding specifications, operating parameters and maintenance requirements.

Swing speed 2.1 rpm (2.1 min⁻¹)
Travel speed 0.69~0.44 miles (1.1 / 0.7 km / h)
 Line speeds based on single line, no loads and first layer of rope drum.

1. GENERAL DESCRIPTION

Type	Crawler mounted, fully revolving
Maximum lifting capacity	250 ton / 500,000 lbs. (226,800 kg) (at 14' (4.27 m) operating radius, with 50' (15.24 m) boom)
Maximum boom length	300' (91.44 m)
Maximum boom & jib length	250' + 100' (76.20 m + 30.48 m)
Basic boom length	50' (15.24 m)
Working weight	Approx. 458,600 lbs (208,020 kg) (Including Upper and Lower machine, counterweights, carbody weights, 50' boom, 250 ton Hook block)
Ground pressure (with basic boom)	Approx. 13.7 psi (95 kPa)
Gradeability (with basic boom)	30%

2. GENERAL DIMENSIONS



Height to top of cab	12' 4" (3,770 mm)
Width of upper machine with operator's cab	12' 0" (3,658 mm)
Radius of rear end (counterweight)	19' 8" (6,000 mm)
Counterweight ground clearance	4' 9" (1,450 mm)
Center of rotation to boom foot pin	4' 7" (1,400 mm)
Height from ground to boom foot pin	8' 3" (2,523 mm)
Height over gantry (raised)	22' 2" (6,750 mm)
Overall length of crawler	29' 0" (8,830 mm)
Center to center of tumblers	25' 5" (7,735 mm)
Overall width of crawlers	23' 8" (7,220 mm)
Shoe width	48" (1,220 mm)
Ground clearance of carbody	17" (430 mm)

3. WORKING SPEED

Line speeds are based on a single line on the first drum layer with no load on it.

Hoist line speed (front and rear drum)	360' / min (110 m / min)
Lowering line speed (front and rear drum)	360' / min (110 m / min)
Boom hoist line speed	170' / min (52 m / min)
Boom lowering line speed	170' / min (52 m / min)

4. UPPER MACHINERY



4.1 Power plant

Diesel engine, make and model Mitsubishi 6D24-TLA2F
No. of cylinders - 6
Bore X stroke: 5.125" X 6.125" (130 mm X 156 mm)
Cycles : 4
Total displacement: 729 in³ (11.945 liters)
Rated output (SAE gross) 316 HP @ 2,000 rpm
 (235 kW / 2,000 min⁻¹)

Maximum torque: 811 lbs•ft / 1,400 rpm
 (126 kgf•m / 1,400 rpm)

Starter : 24 V / 5.5 kW
Alternator: 24 V / 80AMP

Batteries: Two 12 volt, 150 ampere-hour capacity series connected

Radiator: Corrugated type core, thermostatically controlled

Throttle: Twist grip type hand throttle, electrically actuated

Air cleaner: Dry type with replaceable paper element

Fuel Tank: 105 US gal (400 liters) capacity

Lube oil filter: Full flow and by-pass type with replaceable paper element

Fuel filter : Heavy duty with replaceable paper element

4.2 Hydraulic pumps

All driven from heavy duty pump drive.

Hoist and propel: 2 Piston pumps

Boom: 1 Piston pump

Swing: 1 Piston pump

Control system and auxiliary: 2 Gear pumps

4.3 Counterweight

Upper weight 177,700 lbs (80,600 kg)

Carbody weight 44,100 lbs (20,000 kg)

4.4 Gantry

This high folding type gantry is fitted with a sheave frame for boom hoist reeving. Hydraulic lift is standard. It provides full up, full down positions with linkage.

4.5 Operator's Cab

Totally enclosed from weather, this full-vision cab has safety glass all around with a sliding front window. The adjustable, high-backed seat with armrest is standard, allowing operators to customize the position. Auxiliary controls and instruments are on a side mounted console. A signal horn, air conditioner and cigarette lighter are all standard features.



4.6 Controls

At the operator's right are console-mounted adjustable, short levers for the front and rear drum controls and the boom hoist control. Beside the operator's seat on the right are two short levers for propel control. At the operator's left are the console mounted swing lever, knobs for the front and rear drum, the boom drum pawls, engine start/stop key, individual speed shifts for the front and rear drum, boom drum, swing and propel, and the swing mode switch. A swing brake switch and signal horn button are on the swing lever.

4.7 Electrical System

All wiring is coded for easy servicing with individual, fused branch circuits.



4.8 Hydraulic System

Maximum pressure rating: 4,480 psi (315 kg/cm²)
Cooling: Oil-to-air heat exchanger
Filtration: Full-flow filters with replaceable paper elements
Reservoir capacity: 137.4 US gal (520 liters)

4.9 Boom Hoist System

Powered by a hydraulic motor through a planetary reducer.

Drum: Double drum
 Grooved for 7/8" (22 mm) dia. wire rope
Brake: A spring-set, hydraulically-released, multiple-disc brake is mounted on the boom hoist motor and operated through a counter-balance valve. An external ratchet is fitted for locking the drums.

4.10 Front Drum

Powered by a hydraulic motor through a planetary reducer.

Drum: 24.3" (617 mm) P.C.D. X 32.8" (833.7 mm) Lg., grooved for 1" (25.4 mm) wire rope. Rope capacity is 1,575' (480 m) working, 1,969' (600 m) storage length.
Brake: A spring-set, hydraulically-released, multiple-disc brake is mounted on the hoist motor and operated through a counter-balance valve. An external ratchet is fitted for locking the drums.

4.11 Rear Drum

Powered by a hydraulic motor through a planetary reducer.

Drum: 24.3" (617.4 mm) P.C.D X 32.8" (833.7 mm) Lg. , grooved for 1" (25.4 mm) wire rope. Rope capacity is 1,263' (385 m) working, 1,969' (600 m) storage length.
Brake: A spring-set, hydraulically released, multiple-disc brake is mounted on the hoist motor and operated through a counter-balance valve. An external ratchet is fitted for locking the drums.

4.12 Swing System

Swing function: Powered by dual hydraulic swing motors for a smooth transition of force to the swing gear and enhanced swing life.
Swing brake: A spring-set, hydraulically-released, multiple-disc brake is mounted on the swing motor.
Swing circle: A single-row ball bearing with an internal, integral swing gear.

5. LOWER MACHINERY



5.1 Carbody

The durable carbody features steel welded construction with axles.

5.2 Crawler

Crawler assemblies are designed with a quick-disconnect feature for individual removal as a unit from the axles. Crawler belt tension is maintained by a hydraulic jack force on the track-adjusting bearing block.

5.3 Crawler Driver

The independent, hydraulic propel drive is built into each crawler side frame. Each drive consists of a hydraulic motor propelling a driving tumbler through a planetary gearbox. The hydraulic motor and gearbox are built into the crawler side frame within the shoe width.

5.4 Crawler Brakes

Spring-set, hydraulically-released, multiple disc-type parking brakes are built into each propel drive.

5.5 Steering Mechanism

The hydraulic propel system provides both skid steering (driving one track only) and counter-rotating steering (driving each track in opposite directions).

5.6 Crawler Shoes

67 shoes, 48" (1220 mm) wide each crawler.

5.7 Track Rollers

The track rollers are sealed for maintenance-free operation.

6. CRANE ATTACHMENTS



6.1 Crane Boom

The welded lattice construction uses tubular, high-tension steel chords with pin connections between sections.

Extendible up to 300' (91.44 m).

Basic boom length 50' (15.24 m)
Boom base section 25' (7.62 m)
Boom tip section 25' (7.62 m)

6.2 Boom Insert (Optional)

An optional boom insert is available to provide extension capabilities. It also has welded lattice construction with

tubular, high-tension steel chords and pin connections.
 10' (3.05 m)
 20' (6.10 m)
 40' (12.20 m)



6.3 Jib (Optional)

The optional jib employs welded lattice construction with tubular, high-tension steel chords and pin connections between sections.

Extendible up to 100' (30.48 m)

Basic jib length 40' (12.19 m)
Jib base section 15' (4.57 m)
Jib tip section 15' (4.57 m)
Jib insert 10' (3.05 m)
 20' (6.10 m)

Jib boom inserts are available for extension capabilities. They also have welded lattice construction with tubular, high-tension steel chords and pin connections. Jib booms are extendible on boom lengths of 90' (27.43 m) through 250' (76.20 m).

Note: The jib does not fit on booms exceeding 250' (76.20 m).

6.4 Auxiliary sheave... optional

6.5 Diameter of wire rope

Hoist rope 1" (25.4 mm)
 Boom hoist rope 7/8" (22 mm)
 Boom suspension rope 1 5/16" (34 mm)
 Jib suspension rope 1 1/32" (26 mm)

6.6 Line pull

	Rated line pull	*Maximum line pull
Front Drum	29,500 lbs (13,380 kg)	55,000 lbs (24,950 kg)
Rear Drum	29,500 lbs (13,380 kg)	55,000 lbs (24,950 kg)

*Maximum line pull is not based to wire rope strength. See page 9 for rated single part line working loads.

6.7 Wire rope specifications

Use	Specs	Diameter inch (mm)	Working Length feet (m)	Breaking Strength Lbs (kg)
Front Drum	IWRC C/O 6 X Fi (25)	1" (25.4)	1,575' (480)	103,500 (46,900)
Rear Drum	IWRC C/O 6 X Fi (25)	1" (25.4)	1,263' (385)	103,500 (46,900)
Boom Hoist Drum	IWRC O/O 6 X WS (31)	7/8" (22)	1,148' (350)	89,330 (40,500)
Luffing Jib Drum	IWRC O/O 6 X WS (31)	7/8" (22)	870' (265)	89,330 (40,500)

6.8 Boom hoist reeving: twenty (20) parts of 7/8" (22 mm) dia. high strength wire rope.

6.9 Boom backstops: Required for all boom lengths.

7. AUXILIARY EQUIPMENT

7.1 Lights

2 - Front flood lights
 1 - Cab inside light

7.2 Gauges and warning display

1 - Tachometer
 1 - Hour meter
 1 - Fuel gage
 1 - Water temperature gage for engine

Warning display: Battery charge
 Engine oil pressure
 Air cleaner
 Engine oil filter
 Control main pressure
 Hydraulic oil temperature

8. SAFETY SERVICE

Function lock lever
 Anti-two-block
 Boom over hoist limit switch
 Boom angle indicator
 Signal horn
 Boom hoist drum lock
 Front and rear hoist drum lock
 Swing lock
 Swing alarm (Buzzer and lamps)
 Boom backstops
 Over load protective device (Moment limiter) — optional

9. TRANS-LIFTER

The trans-lifter system allows quick and easy removal of the crawler side frames and trailer loading for transport. Four vertical cylinders lift the basic machine for self-loading onto a trailer. Four horizontal axle pin cylinders facilitate the removal and replacement of the side frames.

10. TOOLS AND ACCESSORIES

A complete set of standard tools and accessories is furnished.

11. MAST

Fitted with a point sheave, the newly designed mast enhances lifting capabilities and also handling of major components during self-erection. Raises and lowers by means of a hydraulic cylinder.

GENERAL DIMENSIONS

Unit: ft-in(mm)

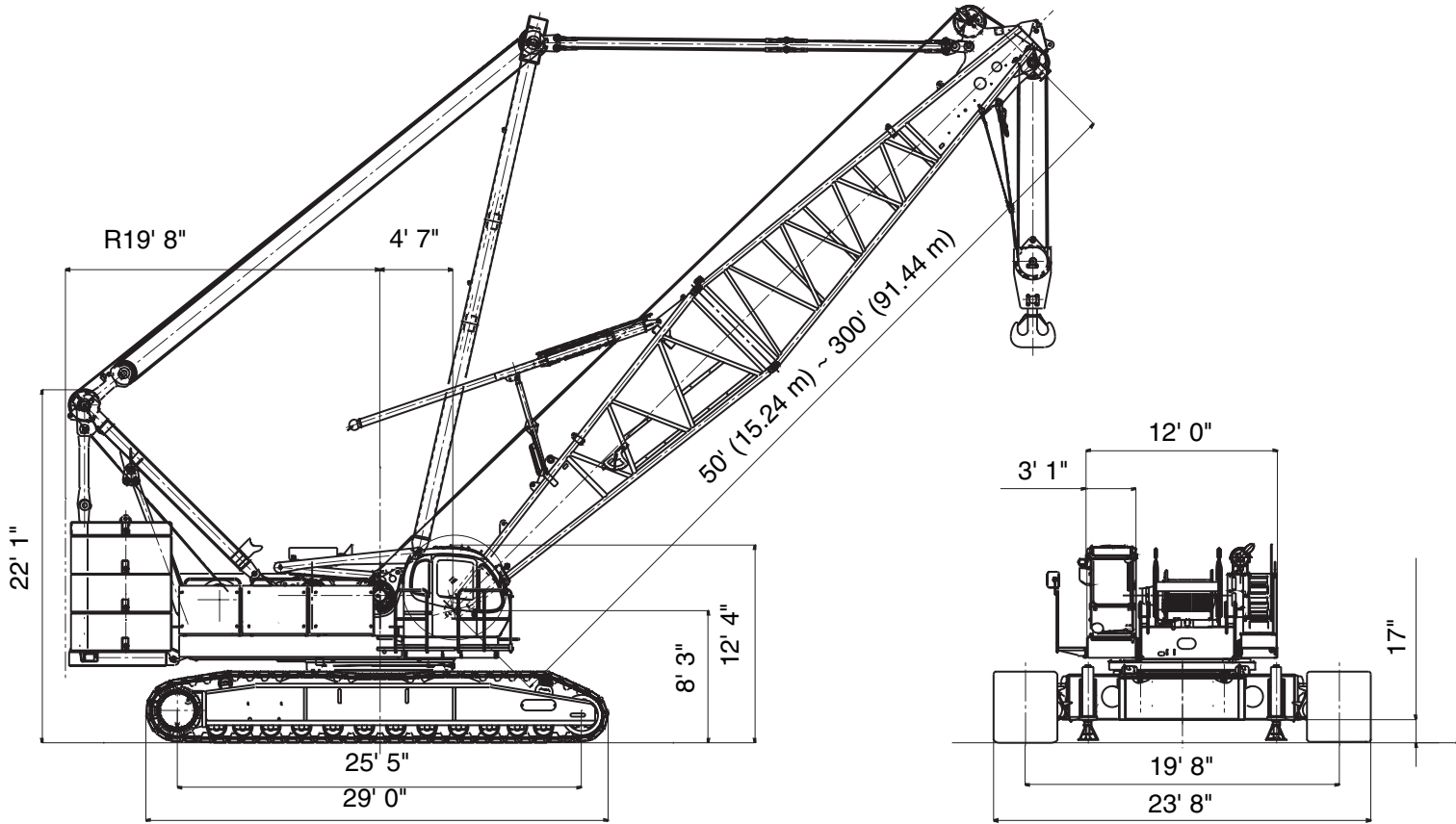

UPPER MACHINERY LAYOUT

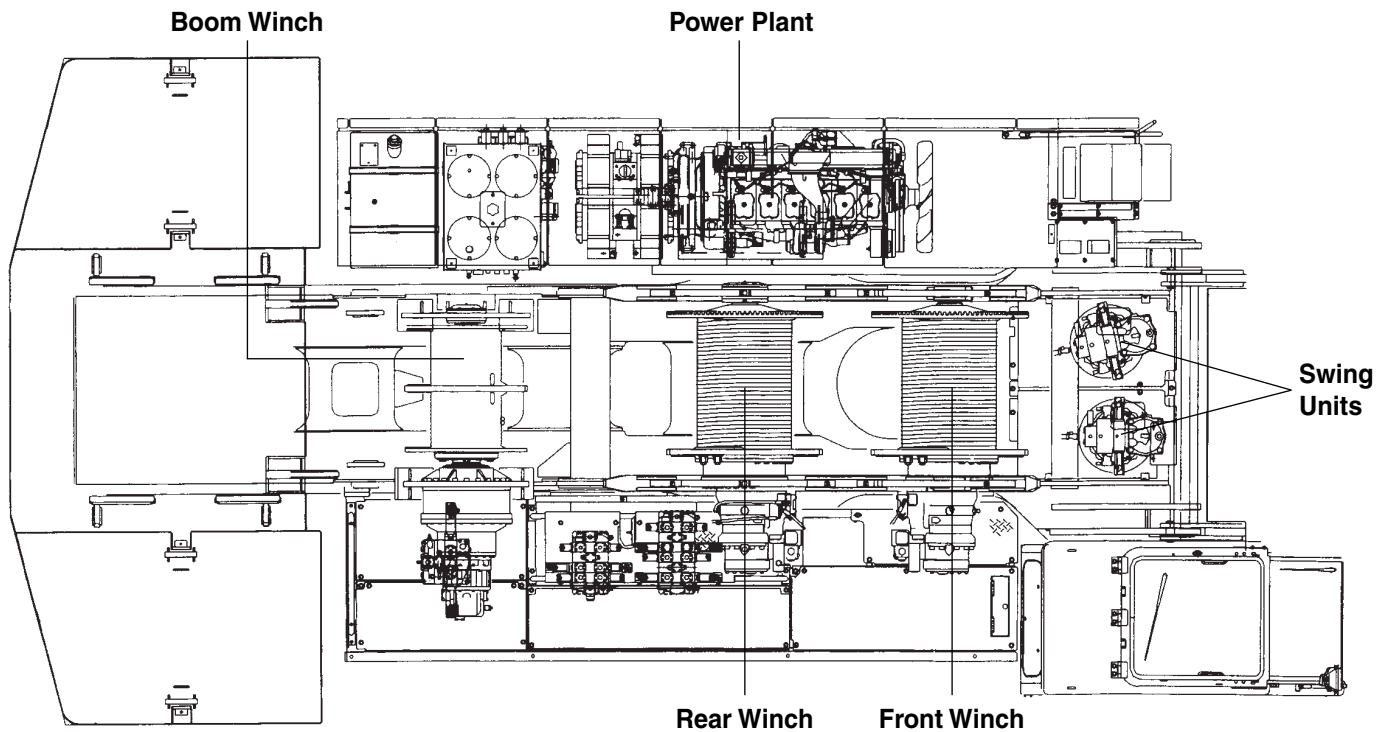

MAIN BOOM WORKING RANGES

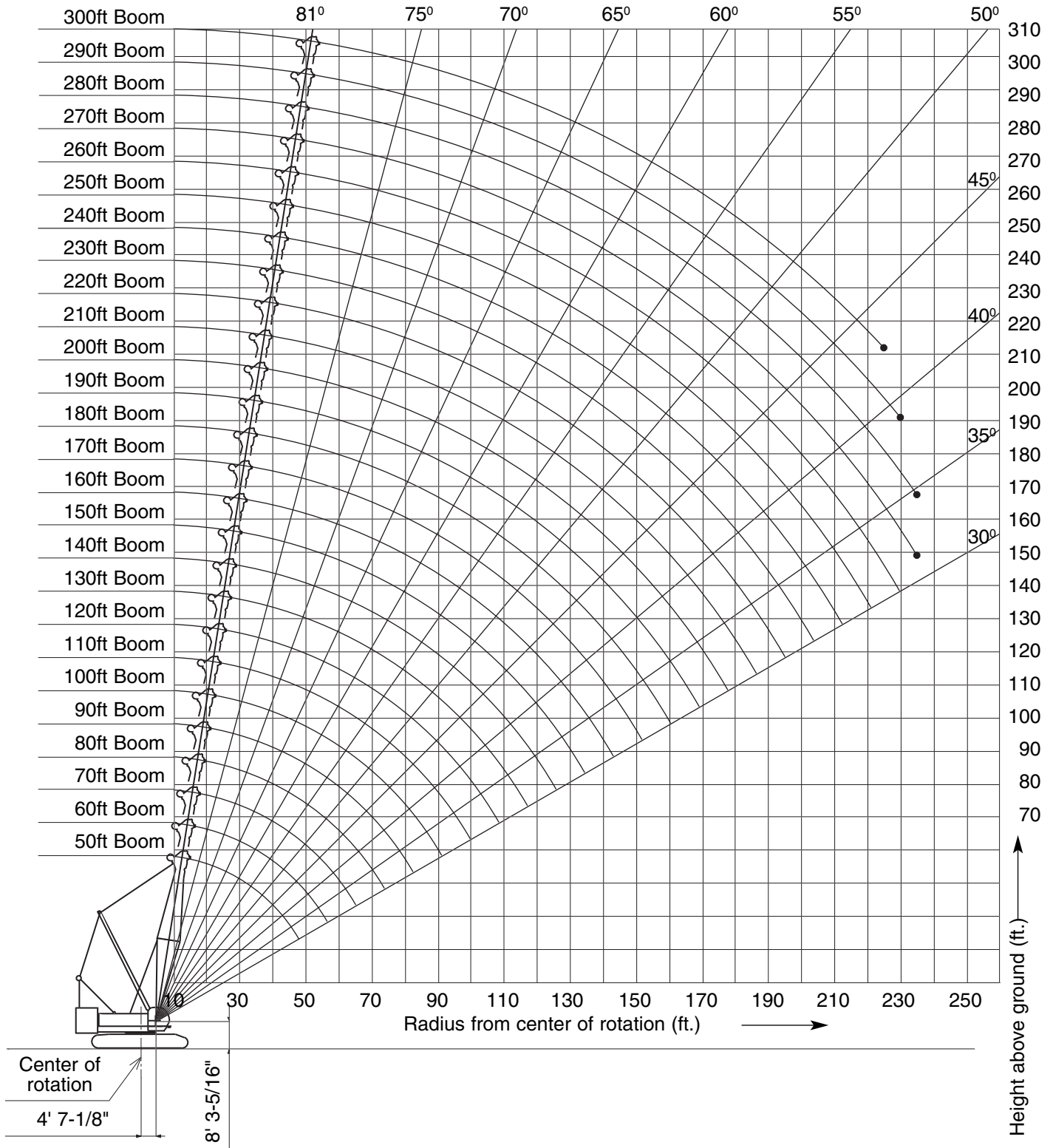

JIB WORKING RANGES (Jib offset 10°)

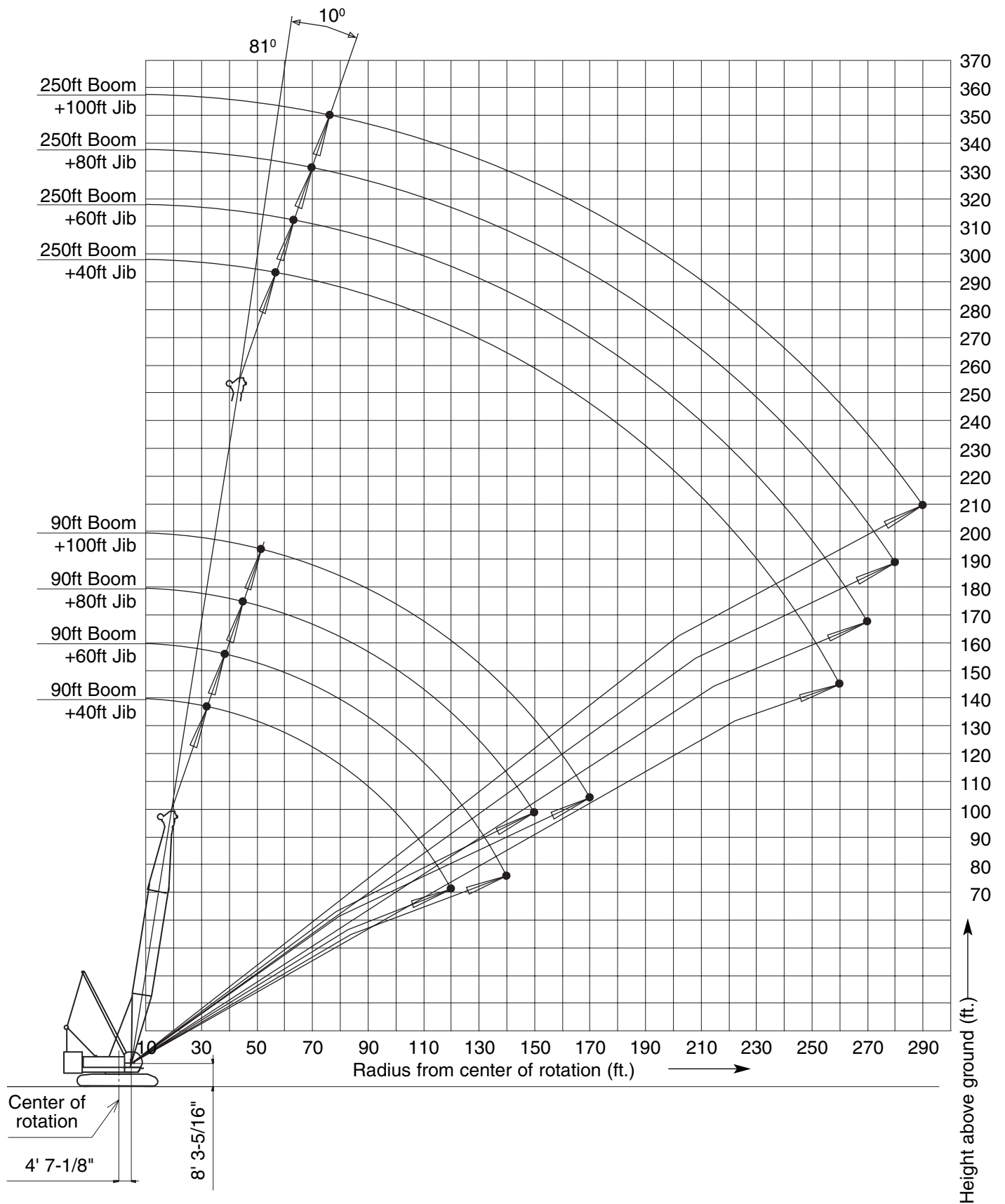

JIB WORKING RANGES (Jib offset 30°)

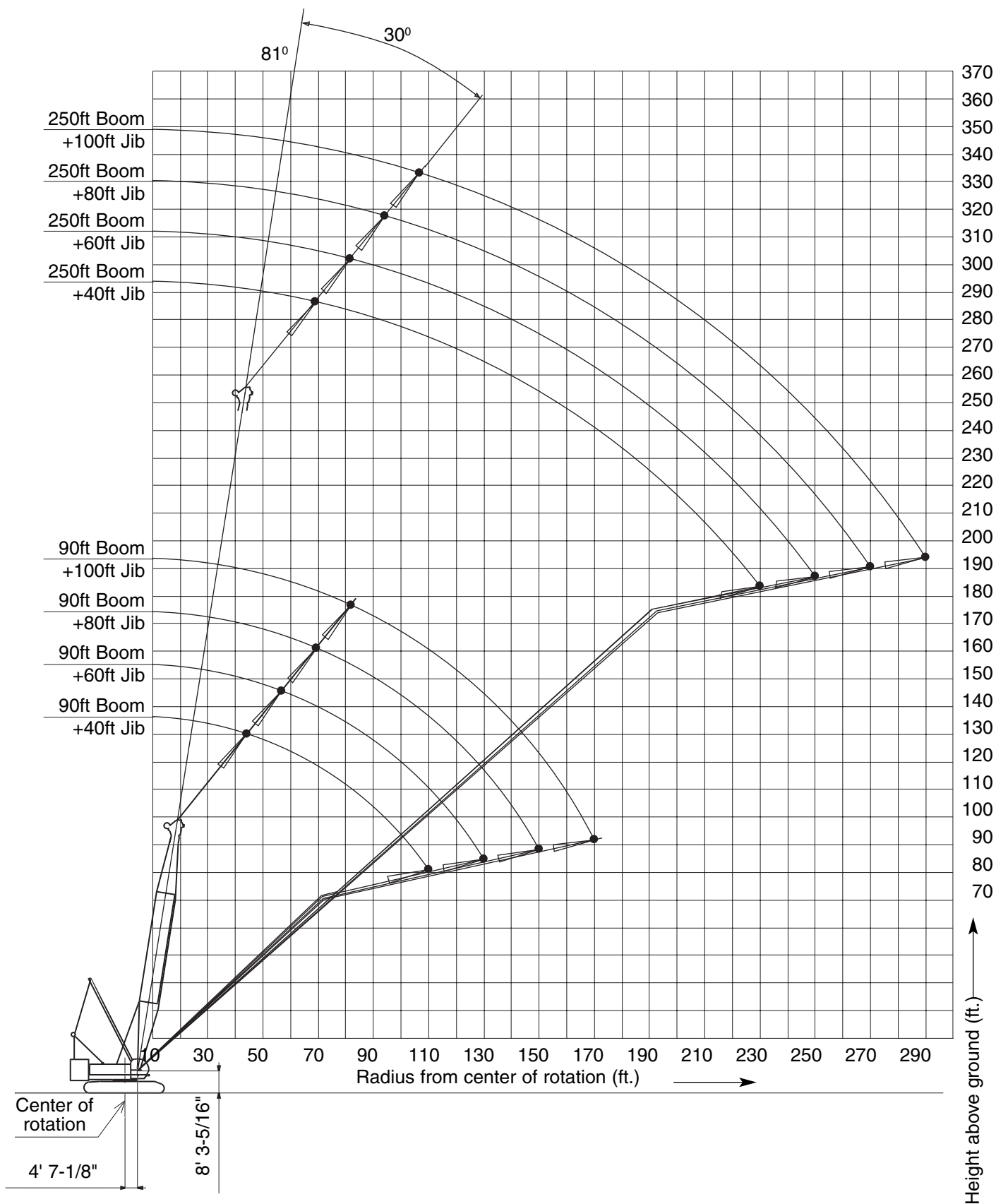

BOOM AND GUY WIRE ARRANGEMENT

Symbol	Dia in.(mm)	Length ft-in(m)
A	Ø 1 15/16" (34)	15' (4.390)
B	Ø 1 15/16" (34)	10' (3.050)
C	Ø 1 15/16" (34)	20' (6.100)
D	Ø 1 15/16" (34)	40' (12.20)

For most efficient use of this machine, boom and guy line arrangement must be correctly observed as shown.

➤ Location of jib backstay lug
 * Manufacturer's recommended boom arrangement makes shorter boom arrangements possible.

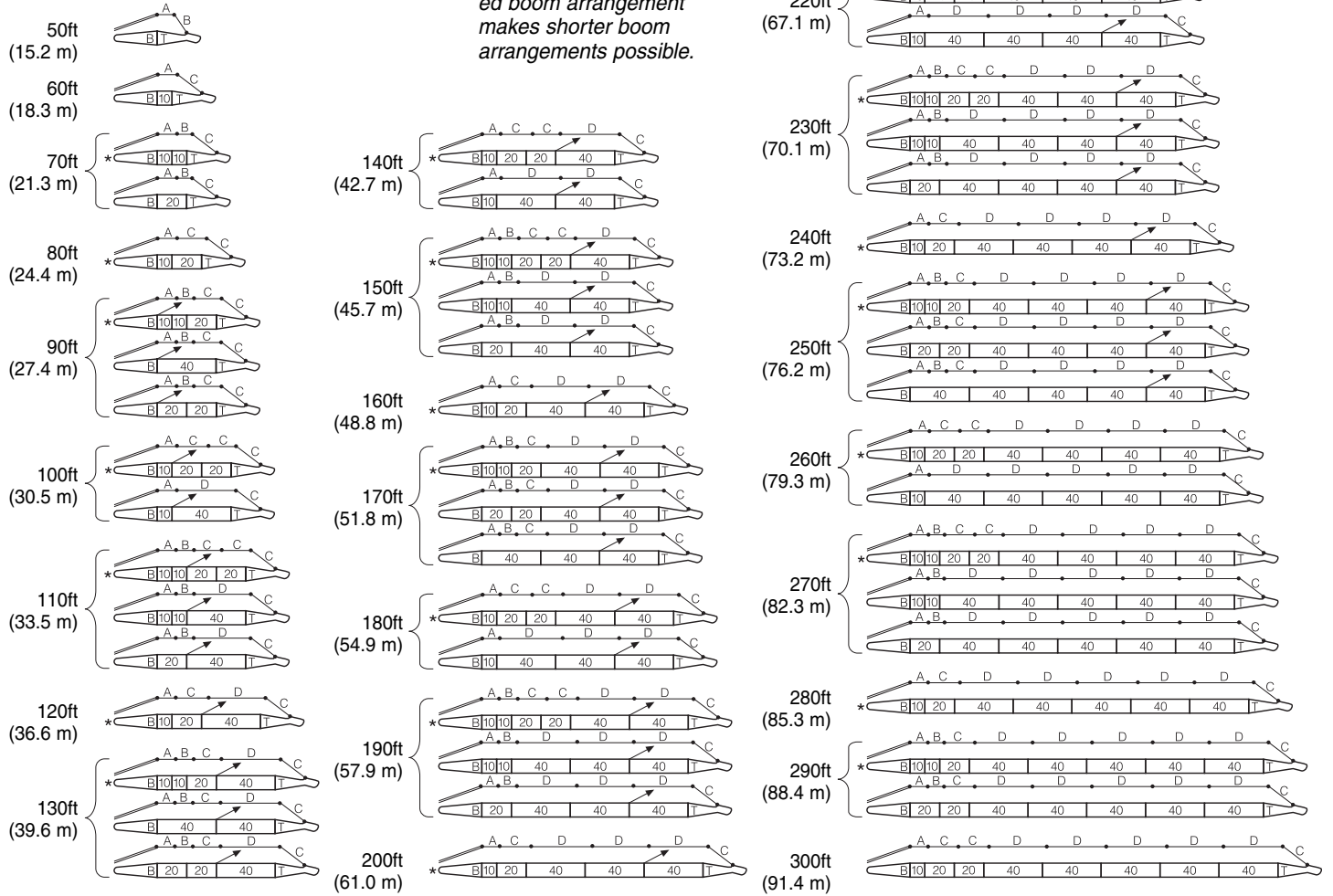

JIB AND GUY WIRE ARRANGEMENT

Symbol	Dia in.(mm)	Length ft-in(m)
E	Ø 1" (26)	87' 2" (26.58)
F	Ø 1" (26)	38' 6" (11.73)
G	Ø 1" (26)	65' 11" (20.08)
H	Ø 1" (26)	4' 5" (1.63)

Arrangement of Guy Line (Boom Side)	
Boom Arrangement	(Tip + 40')
Offset Angle	Arrangement
10°	G
30°	G + H

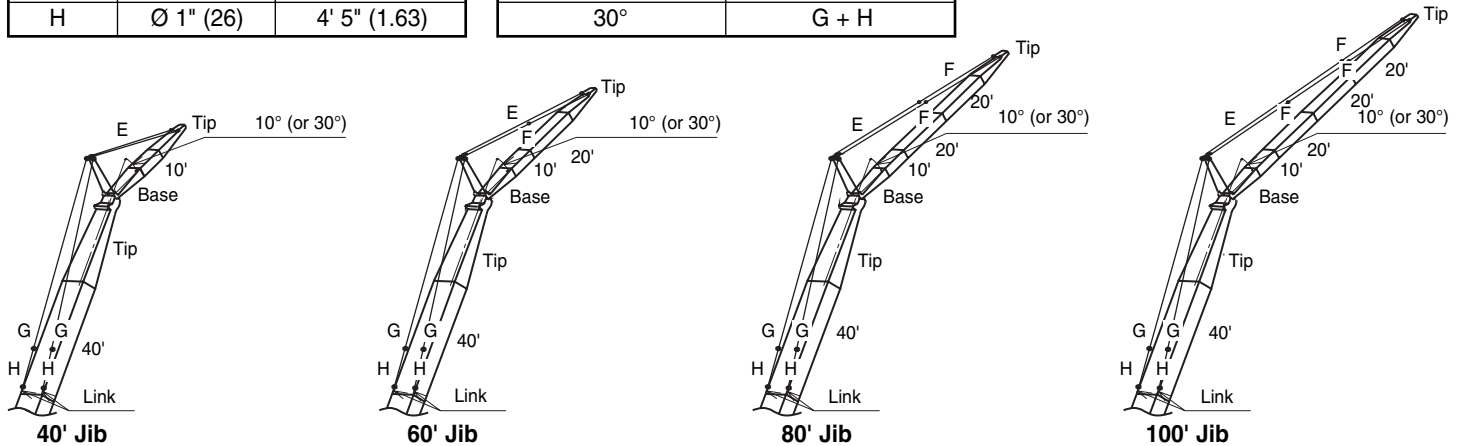

RATING CHART SUPPLEMENTAL DATA

- Rated loads included in the charts are the maximum allowable freely suspended loads at a given boom length, boom angle and load radii and have been determined for the machine standing level on firm supporting surface under ideal operating conditions. The user must limit or de-rate rated loads to allow for adverse conditions (such as soft or uneven ground, out-of-level conditions, wind, side loads, pendulum action, jerking or sudden stopping of loads, inexperience of personnel, multiple machine lifts, and traveling with a load).
- Capacities do not exceed 75% of minimum tipping loads. Capacities based on factors other than machine stability such as structural competence are shown by asterisk* in the charts.
- The machine must be reeved and set-up as stated in the operation manual and all the instruction manuals if these manuals are missing, obtain replacements. Boom backstops are required for all boom lengths. Gantry must be fully raised position for all operations. The crane must be leveled to within 1% on a firm supporting surface.

- Do not attempt to lift where no radius on load is listed as crane may tip or collapse.
- Attempting to lift more than rated loads may cause machine to tip or collapse. Do not tip machine to determine capacity.
- Weight of hooks, hook blocks, slings and other lifting devices are a part of the total load. Their total weight must be subtracted from the rated load to obtain the weight that can be lifted.
- To prevent the boom from leaning toward backward, the own weight of hook block attached to boom point must be equal to or more than that of shown below.

Boom length (ft)	50	60	70	80
Own weight of hook block (lbs)	6,000	3,800	2,500	1,900

- When lifting over boom point with jib or auxiliary sheave, rated loads for the boom must be deducted as shown below.

Jib length (ft)	Aux	40	60	80	100
Deductions (lbs)	800	7,055	8,010	8,965	9,920

- The total load that can be lifted over a jib is limited by rated jib loads.
- Boom lengths for jib mounting are 90 ft (27.4 m) to 250 ft (76.2 m)

- The total load that can be lifted over an auxiliary sheave is the value for 800 lbs deducted from rated load for the boom without auxiliary sheave, but it should not exceed 29,500 lbs.
- Boom lengths that can attach auxiliary sheave are from 50 ft (15.2 m) to 300 ft (91.4 m).
- The boom should be erected over the front of the crawlers, not laterally. When erecting and lowering the boom at length of 290 ft (88.4 m) or over, the blocks for erection must be placed at the end of the crawlers.
- Least stable position is over the side.
- Maximum hoist load for number of reeving parts of line for hoist rope.

Main boom hoist loads

Parts of lines	1	2	3	4	5
Maximum loads (lbs)	29,500	59,000	88,500	118,000	147,500

Parts of lines	6	7	8	9	10
Maximum loads (lbs)	177,000	206,500	236,000	265,500	295,000

Parts of lines	12	14	16	18
Maximum loads (lbs)	354,000	413,000	472,000	500,000

Jib hoist loads

Parts of lines	1	2
Maximum loads (lbs)	29,500	59,000

Auxiliary sheave hoist loads

Parts of lines	1
Maximum loads (lbs)	29,500

- Lifting capacities listed apply only to the machine as originally manufactured and designed by KOBELCO CONSTRUCTION MACHINERY CO.,LTD. Modifications to this machine or use of equipment other than that specified can reduce operating capacity.
- Designed and rated to comply with ANSI Code B30.5.

Operation of this equipment in excess of rated loads or disregard of instruction voids the warranty.

CK2500 Main Boom Loads in Pounds

Refer to notes page 9.

9 Counterweights + 2 Low Weights

50' Boom			60' Boom			70' Boom			80' Boom		
Load Radius (ft.)	Boom Angle (deg.)	360° Rated Load (lbs.)	Load Radius (ft.)	Boom Angle (deg.)	360° Rated Load (lbs.)	Load Radius (ft.)	Boom Angle (deg.)	360° Rated Load (lbs.)	Load Radius (ft.)	Boom Angle (deg.)	360° Rated Load (lbs.)
14.0	80.8	500000*	16.0	80.4	441900*	18.0	80.1	395900*	19.0	80.6	376000*
15.0	79.6	469200*	17.0	79.4	418000*	19.0	79.3	376500*	20.0	79.9	358200*
16.0	78.4	442400*	18.0	78.4	396400*	20.0	78.4	358700*	22.0	78.4	327200*
17.0	77.3	418500*	19.0	77.5	377000*	22.0	76.8	327700*	24.0	77.0	301200*
18.0	76.1	396900*	20.0	76.5	359200*	24.0	75.1	301700*	26.0	75.5	278700*
19.0	74.9	377500*	22.0	74.5	328200*	26.0	73.4	279300*	28.0	74.0	259400*
20.0	73.7	359700*	24.0	72.5	302200*	28.0	71.6	259900*	30.0	72.5	242600*
22.0	71.3	328700*	26.0	70.5	279800*	30.0	69.9	243100*	32.0	71.0	227800*
24.0	68.8	302700*	28.0	68.4	260400*	32.0	68.1	228300*	34.0	69.4	214600*
26.0	66.3	280400*	30.0	66.3	243600*	34.0	66.3	215100*	36.0	67.9	201500
28.0	63.7	261000*	32.0	64.2	228800*	36.0	64.5	201200	38.0	66.3	186200
30.0	61.1	244100*	34.0	62.0	215600*	38.0	62.7	186000	40.0	64.7	173000
32.0	58.4	229300*	36.0	59.8	201200	40.0	60.8	173000	42.0	63.1	161500
34.0	55.6	216100*	38.0	57.5	186000	42.0	58.9	161300	44.0	61.5	151200
36.0	52.7	201000	40.0	55.2	173000	44.0	56.9	151200	46.0	59.8	142100
38.0	49.7	185800	42.0	52.8	161500	46.0	54.9	142100	48.0	58.2	134200
40.0	46.6	172800	44.0	50.3	151400	48.0	52.8	134200	50.0	56.4	126900
42.0	43.2	161300	46.0	47.7	142400	50.0	50.7	126900	55.0	52.0	111500
44.0	39.6	151200	48.0	45.0	134200	55.0	45.1	111500	60.0	47.2	99400
46.0	35.7	142100	50.0	42.2	126900	60.0	38.9	99400	65.0	42.0	89200
48.0	31.4	134200	55.0	34.2	111700	65.0	31.5	89500	70.0	36.2	81100

90' Boom			100' Boom			110' Boom			120' Boom		
Load Radius (ft.)	Boom Angle (deg.)	360° Rated Load (lbs.)	Load Radius (ft.)	Boom Angle (deg.)	360° Rated Load (lbs.)	Load Radius (ft.)	Boom Angle (deg.)	360° Rated Load (lbs.)	Load Radius (ft.)	Boom Angle (deg.)	360° Rated Load (lbs.)
22.0	79.7	326700*	24.0	79.6	300300*	24.0	80.6	299900*	26.0	80.4	277000*
24.0	78.4	300700*	26.0	78.4	277800*	26.0	79.5	277400*	28.0	79.4	257700*
26.0	77.1	278200*	28.0	77.3	258500*	28.0	78.5	258100*	30.0	78.5	240900*
28.0	75.8	258900*	30.0	76.1	241700*	30.0	77.4	241300*	32.0	77.5	226100*
30.0	74.5	242100*	32.0	74.9	226900*	32.0	76.3	226500*	34.0	76.5	212900*
32.0	73.2	227300*	34.0	73.7	213700*	34.0	75.2	213300*	36.0	75.5	201000
34.0	71.8	214100*	36.0	72.5	201200	36.0	74.1	200800	38.0	74.5	185800
36.0	70.5	201200	38.0	71.3	186000	38.0	73.1	185600	40.0	73.5	172600
38.0	69.1	186000	40.0	70.1	172600	40.0	72.0	172300	42.0	72.5	160900
40.0	67.7	172800	42.0	68.8	161100	42.0	70.9	160700	44.0	71.5	150700
42.0	66.3	161300	44.0	67.6	151000	44.0	69.7	150500	46.0	70.5	141700
44.0	64.9	151000	46.0	66.4	141900	46.0	68.6	141500	48.0	69.5	133500
46.0	63.5	141900	48.0	65.1	133800	48.0	67.5	133300	50.0	68.4	126300
48.0	62.1	133800	50.0	63.8	126500	50.0	66.4	126100	55.0	65.8	110800
50.0	60.6	126500	55.0	60.5	111100	55.0	63.5	110600	60.0	63.2	98500
55.0	56.8	111300	60.0	57.2	98700	60.0	60.5	98300	65.0	60.5	88400
60.0	52.9	98900	65.0	53.7	88800	65.0	57.4	88100	70.0	57.7	80000
65.0	48.7	89000	70.0	50.0	80400	70.0	54.3	79800	75.0	54.8	72900
70.0	44.3	80600	75.0	46.1	73400	75.0	50.9	72700	80.0	51.8	66700
75.0	39.4	73600	80.0	41.9	67200	80.0	47.5	66700	85.0	48.6	61700
80.0	34.0	67400	85.0	37.3	62100	85.0	43.8	61500	90.0	45.3	57000
			90.0	32.2	57500	90.0	39.8	56800	95.0	41.8	52900
						95.0	35.5	52900	100.0	38.0	49300
						100.0	30.6	49300	105.0	33.9	46200

CK2500 Main Boom Loads in Pounds

Refer to notes page 9.

9 Counterweights + 2 Low Weights

130' Boom			140' Boom			150' Boom			160' Boom		
Load Radius (ft.)	Boom Angle (deg.)	360° Rated Load (lbs.)	Load Radius (ft.)	Boom Angle (deg.)	360° Rated Load (lbs.)	Load Radius (ft.)	Boom Angle (deg.)	360° Rated Load (lbs.)	Load Radius (ft.)	Boom Angle (deg.)	360° Rated Load (lbs.)
28.0	80.2	257300*	30.0	80.1	240100*	32.0	80.0	224900*	34.0	79.9	211400*
30.0	79.4	240500*	32.0	79.3	225300*	34.0	79.2	211700*	36.0	79.2	200300
32.0	78.5	225700*	34.0	78.5	212100*	36.0	78.5	200300	38.0	78.5	184900
34.0	77.5	212500*	36.0	77.6	200600	38.0	77.7	184900	40.0	77.7	171500
36.0	76.6	200800	38.0	76.8	185100	40.0	76.9	171700	42.0	77.0	160000
38.0	75.7	185600	40.0	75.9	171900	42.0	76.1	160000	44.0	76.2	149600
40.0	74.8	172300	42.0	75.1	160200	44.0	75.3	149600	46.0	75.5	140600
42.0	73.9	160700	44.0	74.2	150100	46.0	74.5	140600	48.0	74.8	132200
44.0	73.0	150300	46.0	73.4	140800	48.0	73.7	132400	50.0	74.0	125000
46.0	72.0	141300	48.0	72.5	132700	50.0	72.9	125200	55.0	72.1	109500
48.0	71.1	133100	50.0	71.7	125400	55.0	70.9	109500	60.0	70.2	97200
50.0	70.2	125800	55.0	69.5	110000	60.0	68.9	97200	65.0	68.3	87000
55.0	67.8	110400	60.0	67.3	97600	65.0	66.8	87000	70.0	66.4	78700
60.0	65.4	98100	65.0	65.0	87500	70.0	64.7	78700	75.0	64.4	71400
65.0	62.9	87900	70.0	62.7	79100	75.0	62.5	71600	80.0	62.4	65400
70.0	60.4	79500	75.0	60.4	72000	80.0	60.4	65400	85.0	60.3	60100
75.0	57.8	72500	80.0	58.0	65900	85.0	58.1	60100	90.0	58.2	55500
80.0	55.2	66300	85.0	55.5	60600	90.0	55.8	55500	95.0	56.1	51300
85.0	52.4	61000	90.0	53.0	55900	95.0	53.5	51500	100.0	53.9	47800
90.0	49.6	56600	95.0	50.4	52000	100.0	51.0	47800	105.0	51.6	44500
95.0	46.6	52400	100.0	47.6	48500	105.0	48.5	44700	110.0	49.3	41600
100.0	43.4	48900	105.0	44.8	45100	110.0	45.9	41800	115.0	46.9	39000
105.0	40.1	45600	110.0	41.7	42300	115.0	43.1	39200	120.0	44.3	36500
110.0	36.4	42700	115.0	38.5	39600	120.0	40.2	36800	125.0	41.7	34600
115.0	32.5	40300	120.0	35.1	37400	125.0	37.2	34600	130.0	38.9	32600
			125.0	31.3	35200	130.0	33.8	32600	135.0	35.9	30800
						135.0	30.2	30800	140.0	32.7	29100

170' Boom			180' Boom			190' Boom			200' Boom		
Load Radius (ft.)	Boom Angle (deg.)	360° Rated Load (lbs.)	Load Radius (ft.)	Boom Angle (deg.)	360° Rated Load (lbs.)	Load Radius (ft.)	Boom Angle (deg.)	360° Rated Load (lbs.)	Load Radius (ft.)	Boom Angle (deg.)	360° Rated Load (lbs.)
34.0	80.5	211000*	36.0	80.4	199700	38.0	80.3	183800	40.0	80.2	170600
36.0	79.8	199900	38.0	79.8	184300	40.0	79.7	170600	42.0	79.6	158900
38.0	79.1	184500	40.0	79.1	171000	42.0	79.1	158700	44.0	79.0	148500
40.0	78.5	171000	42.0	78.5	159300	44.0	78.5	148500	46.0	78.5	139300
42.0	77.8	159300	44.0	77.8	149000	46.0	77.8	139300	48.0	77.9	131100
44.0	77.1	149200	46.0	77.1	139700	48.0	77.2	131100	50.0	77.3	123800
46.0	76.4	139900	48.0	76.5	131600	50.0	76.6	123800	55.0	75.8	108200
48.0	75.7	131800	50.0	75.8	124300	55.0	75.0	108200	60.0	74.3	95900
50.0	75.0	124500	55.0	74.2	108600	60.0	73.5	95900	65.0	72.8	85700
55.0	73.2	108900	60.0	72.5	96300	65.0	71.9	85700	70.0	71.3	77100
60.0	71.5	96500	65.0	70.8	86100	70.0	70.3	77100	75.0	69.8	70100
65.0	69.7	86400	70.0	69.1	77800	75.0	68.7	70100	80.0	68.3	63900
70.0	67.9	78000	75.0	67.4	70500	80.0	67.0	63900	85.0	66.7	58600
75.0	66.0	70900	80.0	65.7	64500	85.0	65.4	58600	90.0	65.1	54000
80.0	64.1	64800	85.0	63.9	59300	90.0	63.7	54000	95.0	63.5	49800
85.0	62.3	59500	90.0	62.1	54600	95.0	62.0	49800	100.0	61.9	46200
90.0	60.3	54800	95.0	60.3	50400	100.0	60.3	46200	105.0	60.3	42900
95.0	58.4	50700	100.0	58.4	46900	105.0	58.5	42900	110.0	58.6	40100
100.0	56.3	47100	105.0	56.5	43600	110.0	56.7	40100	115.0	56.9	37400
105.0	54.3	43800	110.0	54.6	40700	115.0	54.9	37400	120.0	55.2	35000
110.0	52.2	41000	115.0	52.6	38100	120.0	53.0	35000	125.0	53.4	32800
115.0	50.0	38300	120.0	50.6	35700	125.0	51.1	32800	130.0	51.6	30800
120.0	47.7	35900	125.0	48.5	33500	130.0	49.1	30800	135.0	49.7	29100
125.0	45.4	33900	130.0	46.3	31500	135.0	47.1	29100	140.0	47.8	27300
130.0	42.9	31900	135.0	44.0	29700	140.0	45.0	27300	145.0	45.8	25700
135.0	40.4	29900	140.0	41.7	27900	145.0	42.8	25700	150.0	43.8	24200
140.0	37.7	28400	145.0	39.2	26400	150.0	40.5	24200	155.0	41.6	22900
145.0	34.8	26800	150.0	36.6	25100	155.0	38.1	22900	160.0	39.4	21600
150.0	31.7	25500	155.0	33.8	23800	160.0	35.5	21800	165.0	37.1	20500
			160.0	30.7	22400	165.0	32.8	20700	170.0	34.6	19400
									175.0	32.0	18500

* Refer to notes page 9.

CK2500 Main Boom Loads in Pounds

Refer to notes page 9.

9 Counterweights + 2 Low Weights

210' Boom			220' Boom			230' Boom			240' Boom		
Load Radius (ft.)	Boom Angle (deg.)	360° Rated Load (lbs.)	Load Radius (ft.)	Boom Angle (deg.)	360° Rated Load (lbs.)	Load Radius (ft.)	Boom Angle (deg.)	360° Rated Load (lbs.)	Load Radius (ft.)	Boom Angle (deg.)	360° Rated Load (lbs.)
42.0	80.1	158500	42.0	80.6	152500*	44.0	80.5	136900*	46.0	80.4	124100*
44.0	79.6	148100	44.0	80.0	147700	46.0	80.0	136000*	48.0	79.9	123200*
46.0	79.0	138800	46.0	79.5	138400	48.0	79.5	130000	50.0	79.4	122100*
48.0	78.5	130700	48.0	79.0	130200	50.0	79.0	122700	55.0	78.2	106900
50.0	77.9	123400	50.0	78.5	122700	55.0	77.7	107100	60.0	77.0	94300
55.0	76.5	107800	55.0	77.1	107300	60.0	76.4	94500	65.0	75.8	84200
60.0	75.1	95200	60.0	75.8	94700	65.0	75.1	84400	70.0	74.5	75600
65.0	73.7	85000	65.0	74.4	84600	70.0	73.8	75800	75.0	73.3	68300
70.0	72.2	76700	70.0	73.1	76000	75.0	72.5	68700	80.0	72.0	62300
75.0	70.8	69400	75.0	71.7	69000	80.0	71.2	62600	85.0	70.8	56800
80.0	69.3	63200	80.0	70.3	62800	85.0	69.9	57300	90.0	69.5	52200
85.0	67.9	57900	85.0	68.9	57500	90.0	68.6	52400	95.0	68.2	48200
90.0	66.4	53300	90.0	67.5	52900	95.0	67.2	48500	100.0	66.9	44500
95.0	64.9	49100	95.0	66.1	48700	100.0	65.8	44700	105.0	65.6	41200
100.0	63.4	45600	100.0	64.7	45100	105.0	64.5	41400	110.0	64.3	38300
105.0	61.8	42300	105.0	63.2	41800	110.0	63.1	38500	115.0	62.9	35700
110.0	60.3	39400	110.0	61.7	39000	115.0	61.7	35900	120.0	61.6	33200
115.0	58.7	36800	115.0	60.2	36300	120.0	60.2	33500	125.0	60.2	31000
120.0	57.1	34300	120.0	58.7	33900	125.0	58.8	31300	130.0	58.8	29100
125.0	55.4	32100	125.0	57.2	31700	130.0	57.3	29300	135.0	57.4	27100
130.0	53.7	30200	130.0	55.6	29700	135.0	55.8	27300	140.0	56.0	25300
135.0	52.0	28400	135.0	54.0	27700	140.0	54.3	25700	145.0	54.5	23800
140.0	50.2	26600	140.0	52.4	26000	145.0	52.7	24200	150.0	53.0	22400
145.0	48.4	25100	145.0	50.7	24400	150.0	51.1	22700	155.0	51.5	20900
150.0	46.6	23500	150.0	49.0	23100	155.0	49.5	21300	160.0	50.0	19800
155.0	44.6	22200	155.0	47.2	21800	160.0	47.8	20000	165.0	48.4	18500
160.0	42.7	20900	160.0	45.4	20500	165.0	46.1	18900	170.0	46.8	17400
165.0	40.6	19800	165.0	43.6	19400	170.0	44.4	17600	175.0	45.1	16300
170.0	38.4	18700	170.0	41.6	18200	175.0	42.5	16500	180.0	43.4	15200
175.0	36.2	17800	175.0	39.6	17100	180.0	40.7	15400	185.0	41.6	14100
180.0	33.7	16700	180.0	37.5	16000	185.0	38.7	14500	190.0	39.8	13200
185.0	31.2	15800	185.0	35.3	15200	190.0	36.6	13600	195.0	37.8	12300
			190.0	32.9	14100	195.0	34.5	12700	200.0	35.8	11400
			195.0	30.4	13400	200.0	32.2	11900	205.0	33.7	10800
									210.0	31.5	9900

CK2500 Main Boom Loads in Pounds

Refer to notes page 9.

9 Counterweights + 2 Low Weights

250' Boom			260' Boom			270' Boom			280' Boom		
Load Radius (ft.)	Boom Angle (deg.)	360° Rated Load (lbs.)	Load Radius (ft.)	Boom Angle (deg.)	360° Rated Load (lbs.)	Load Radius (ft.)	Boom Angle (deg.)	360° Rated Load (lbs.)	Load Radius (ft.)	Boom Angle (deg.)	360° Rated Load (lbs.)
48.0	80.3	111500*	50.0	80.3	101600*	55.0	79.5	91400*	55.0	79.9	83100*
50.0	79.9	110600*	55.0	79.1	99600*	60.0	78.5	89500*	60.0	78.9	81300*
55.0	78.7	106700	60.0	78.0	93600	65.0	77.4	82800	65.0	77.8	79500*
60.0	77.5	94100	65.0	76.9	83500	70.0	76.3	74200	70.0	76.8	74500
65.0	76.3	83900	70.0	75.7	74900	75.0	75.2	67200	75.0	75.7	67200
70.0	75.2	75300	75.0	74.6	67600	80.0	74.1	61000	80.0	74.7	61000
75.0	74.0	68100	80.0	73.5	61500	85.0	73.0	55500	85.0	73.6	55700
80.0	72.8	61900	85.0	72.3	56200	90.0	71.9	50900	90.0	72.5	50900
85.0	71.6	56600	90.0	71.1	51500	95.0	70.7	46700	95.0	71.5	46900
90.0	70.3	52000	95.0	70.0	47300	100.0	69.6	43200	100.0	70.4	43200
95.0	69.1	47800	100.0	68.8	43600	105.0	68.5	39900	105.0	69.3	39900
100.0	67.9	44300	105.0	67.6	40500	110.0	67.3	36800	110.0	68.2	37000
105.0	66.6	41000	110.0	66.4	37400	115.0	66.2	34100	115.0	67.1	34300
110.0	65.4	37900	115.0	65.2	34800	120.0	65.0	31700	120.0	65.9	31900
115.0	64.1	35200	120.0	64.0	32400	125.0	63.8	29500	125.0	64.8	29700
120.0	62.8	32800	125.0	62.7	30200	130.0	62.6	27500	130.0	63.7	27500
125.0	61.5	30600	130.0	61.5	28200	135.0	61.4	25700	135.0	62.5	25700
130.0	60.2	28600	135.0	60.2	26200	140.0	60.2	24000	140.0	61.4	24000
135.0	58.9	26800	140.0	58.9	24600	145.0	59.0	22400	145.0	60.2	22400
140.0	57.5	25100	145.0	57.6	22900	150.0	57.7	20900	150.0	59.0	20900
145.0	56.2	23500	150.0	56.3	21600	155.0	56.4	19400	155.0	57.8	19400
150.0	54.8	22000	155.0	55.0	20000	160.0	55.2	18000	160.0	56.6	18000
155.0	53.3	20700	160.0	53.6	18700	165.0	53.9	16700	165.0	55.3	16700
160.0	51.9	19400	165.0	52.2	17400	170.0	52.5	15400	170.0	54.1	15400
165.0	50.4	18000	170.0	50.8	16300	175.0	51.2	14300	175.0	52.8	14300
170.0	48.9	16900	175.0	49.4	14900	180.0	49.8	13200	180.0	51.5	13200
175.0	47.4	15600	180.0	47.9	14100	185.0	48.4	12100	185.0	50.2	12100
180.0	45.8	14500	185.0	46.4	13000	190.0	46.9	11200	190.0	48.8	11200
185.0	44.1	13600	190.0	44.8	12100	195.0	45.5	10300	195.0	47.4	10300
190.0	42.5	12700	195.0	43.2	11200	200.0	43.9	9400	200.0	46.0	9400
195.0	40.7	11900	200.0	41.6	10300	205.0	42.4	8800	205.0	44.6	8500
200.0	38.9	11000	205.0	39.9	9400	210.0	40.8	7900	210.0	43.1	7900
205.0	37.0	10100	210.0	38.1	8800	215.0	39.1	7200	215.0	41.6	7000
210.0	35.1	9400	215.0	36.3	7900	220.0	37.4	6600	220.0	40.0	6300
215.0	33.0	8500	220.0	34.4	7200	225.0	35.6	5900	225.0	38.4	5700
220.0	30.8	7900	225.0	32.4	6600	230.0	33.7	5200	230.0	36.7	5000
			230.0	30.2	6100	235.0	31.7	4600	235.0	34.9	4600

290' Boom			300' Boom								
Load Radius (ft.)	Boom Angle (deg.)	360° Rated Load (lbs.)	Load Radius (ft.)	Boom Angle (deg.)	360° Rated Load (lbs.)	Load Radius (ft.)	Boom Angle (deg.)	360° Rated Load (lbs.)	Load Radius (ft.)	Boom Angle (deg.)	360° Rated Load (lbs.)
55.0	80.3	76900*	145.0	61.3	21800	55.0	80.6	71200*	145.0	62.4	21100
60.0	79.3	74900*	150.0	60.2	20200	60.0	79.6	69400*	150.0	61.3	19600
65.0	78.3	73400*	155.0	59.0	18700	65.0	78.7	67600*	155.0	60.2	18000
70.0	77.2	71400*	160.0	57.9	17100	70.0	77.7	66100*	160.0	59.1	16700
75.0	76.2	66700	165.0	56.7	15800	75.0	76.7	63000*	165.0	57.9	15400
80.0	75.2	60600	170.0	55.5	14700	80.0	75.7	59500*	170.0	56.8	14100
85.0	74.2	55100	175.0	54.3	13600	85.0	74.7	54600	175.0	55.7	13000
90.0	73.2	50400	180.0	53.1	12500	90.0	73.7	50000	180.0	54.5	11900
95.0	72.1	46200	185.0	51.8	11400	95.0	72.7	45800	185.0	53.3	10800
100.0	71.1	42500	190.0	50.5	10500	100.0	71.7	42100	190.0	52.1	9900
105.0	70.0	39400	195.0	49.2	9400	105.0	70.7	38800	195.0	50.9	9000
110.0	69.0	36300	200.0	47.9	8800	110.0	69.7	35900	200.0	49.6	8100
115.0	67.9	33700	205.0	46.6	7900	115.0	68.7	33200	205.0	48.4	7200
120.0	66.8	31300	210.0	45.2	7000	120.0	67.6	30800	210.0	47.1	6600
125.0	65.7	29100	215.0	43.8	6300	125.0	66.6	28600	215.0	45.7	5700
130.0	64.7	27100	220.0	42.3	5700	130.0	65.6	26400	220.0	44.4	5000
135.0	63.6	25100	225.0	40.8	5000	135.0	64.5	24600	225.0	43.0	4400
140.0	62.4	23300	230.0	39.3	4400	140.0	63.4	22900			

* Refer to notes page 9.

CK2500 Jib Rating Loads in Pounds

Refer to notes page 9.

9 Counterweights + 2 Low Weights

90' Boom									90' Boom								
Jib Length	40' Jib				60' Jib				Jib Length	80' Jib				100' Jib			
Offset Angle	10°		30°		10°		30°		Offset angle	10°		30°		10°		30°	
Load Radius (ft.)	Boom Angle (deg.)	Rated Load (lbs.)	Boom Angle (deg.)	Rated Load (lbs.)	Boom Angle (deg.)	Rated Load (lbs.)	Boom Angle (deg.)	Rated Load (lbs.)	Load Radius (ft.)	Boom Angle (deg.)	Rated Load (lbs.)	Boom Angle (deg.)	Rated Load (lbs.)	Boom Angle (deg.)	Rated Load (lbs.)	Boom Angle (deg.)	Rated Load (lbs.)
35	79.7	59000*							50	79.3	23600*			80.8	14500*		
40	77.4	55000*			80.5	43100*			55	77.6	23200*			79.2	14100*		
45	75.2	51600*	80.6	37900*	78.5	41900*			60	75.8	22900*			77.7	13900*		
50	72.9	48600*	78.2	36600*	76.5	40900*			65	74.1	22400*			76.1	13600*		
55	70.5	45900*	75.8	35300*	74.5	39900*			70	72.3	21700*	80.7	18100*	74.5	13100*		
60	68.1	43500*	73.4	34200*	72.5	39000*	79.6	29500*	75	70.4	21000*	78.8	17700*	72.9	12600*		
65	65.7	41500*	70.8	33100*	70.5	37200*	77.5	28500*	80	68.6	20300*	76.9	17300*	71.3	12200*	80.9	9900*
70	63.2	39600*	68.3	32200*	68.4	34600*	75.3	27200*	85	66.7	19700*	75.0	16900*	69.6	11700*	79.2	9700*
75	60.7	38000*	65.6	31200*	66.3	32400*	73.1	25900*	90	64.8	19200*	73.0	16600*	68.0	11300*	77.5	9400*
80	58.1	36500*	62.9	30400*	64.1	30400*	70.9	24800*	100	60.9	18100*	68.9	16000*	64.6	10600*	74.0	8900*
85	55.4	35100*	60.1	29700*	61.9	28700*	68.6	23800*	110	56.7	17200*	64.5	15400*	61.1	9900*	70.3	8500*
90	52.5	33800*	57.2	28800*	59.6	27100*	66.2	22900*	120	52.3	16500*	59.9	14900*	57.4	9400*	66.5	8200*
100	46.5	31500*	50.8	27300*	54.9	24500*	61.3	21400*	130	47.6	15800*	54.9	14100*	53.5	8900*	62.5	7900*
110	39.8	29600*	43.6	26100*	49.8	22300*	55.9	20100*	140	42.4	15300*	49.3	13400*	49.4	8500*	58.1	7600*
120	31.7	27500*			44.3	20600*	50.0	19100*	150	36.6	14300*	42.8	12900*	45.0	8100*	53.4	7400*
130					38.0	19100*	43.2	18300*	160					40.2	7800*	48.2	7200*
140					30.5	17900*			170					34.7	7500*	42.1	7200*

100' Boom									100' Boom								
Jib Length	40' Jib				60' Jib				Jib Length	80' Jib				100' Jib			
Offset Angle	10°		30°		10°		30°		Offset Angle	10°		30°		10°		30°	
Load Radius (ft.)	Boom Angle (deg.)	Rated Load (lbs.)	Boom Angle (deg.)	Rated Load (lbs.)	Boom Angle (deg.)	Rated Load (lbs.)	Boom Angle (deg.)	Rated Load (lbs.)	Load Radius (ft.)	Boom Angle (deg.)	Rated Load (lbs.)	Boom Angle (deg.)	Rated Load (lbs.)	Boom Angle (deg.)	Rated Load (lbs.)	Boom Angle (deg.)	Rated Load (lbs.)
35	80.4	59000*							50	79.9	23700*						
40	78.4	56600*							55	78.3	23400*			79.8	14200*		
45	76.3	53200*			79.2	42300*			60	76.7	23000*			78.3	14000*		
50	74.1	50200*	79.1	37100*	77.4	41300*			65	75.0	22700*			76.8	13700*		
55	72.0	47600*	76.9	35900*	75.5	40300*			70	73.3	22100*			75.3	13400*		
60	69.8	45200*	74.7	34800*	73.7	39400*	80.3	29500*	75	71.6	21400*	79.5	17800*	73.8	12900*		
65	67.6	43100*	72.4	33800*	71.8	38600*	78.4	29100*	80	69.9	20800*	77.7	17500*	72.3	12400*		
70	65.3	41200*	70.0	32800*	69.8	36300*	76.4	27800*	85	68.1	20100*	75.9	17100*	70.7	12000*	79.8	9700*
75	63.0	39500*	67.7	31900*	67.9	34000*	74.3	26600*	90	66.3	19600*	74.1	16700*	69.2	11600*	78.2	9500*
80	60.6	37900*	65.2	31100*	65.9	31900*	72.3	25500*	100	62.7	18600*	70.3	16200*	66.0	10900*	74.9	9000*
85	58.2	36600*	62.7	30300*	63.9	30200*	70.2	24500*	110	58.9	17700*	66.3	15600*	62.7	10200*	71.5	8600*
90	55.7	35300*	60.1	29700*	61.8	28500*	68.0	23600*	120	54.9	16900*	62.1	15200*	59.3	9700*	68.0	8300*
100	50.4	33000*	54.6	28100*	57.5	25800*	63.5	22000*	130	50.7	16200*	57.6	14400*	55.7	9100*	64.2	8000*
110	44.7	30900*	48.5	26800*	52.9	23500*	58.8	20700*	140	46.1	15600*	52.8	13800*	52.0	8700*	60.3	7700*
120	38.2	29100*	41.6	25900*	48.1	21700*	53.6	19700*	150	41.1	15100*	47.3	13200*	48.0	8300*	56.1	7500*
130	30.4	27200*			42.7	20100*	47.9	18800*	160	35.4	14100*	41.0	12800*	43.7	8000*	51.5	7300*
140					36.7	18800*	41.3	18100*	170					39.0	7700*	46.4	7200*
									180					33.7	7400*	40.4	7100*

* Refer to notes page 9.

CK2500 Jib Rating Loads in Pounds

Refer to notes page 9.

9 Counterweights + 2 Low Weights

110' Boom									110' Boom								
Jib Length	40' Jib				60' Jib				Jib Length	80' Jib				100' Jib			
Offset Angle	10°		30°		10°		30°		Offset Angle	10°		30°		10°		30°	
Load Radius (ft.)	Boom Angle (deg.)	Rated Load (lbs.)	Boom Angle (deg.)	Rated Load (lbs.)	Boom Angle (deg.)	Rated Load (lbs.)	Boom Angle (deg.)	Rated Load (lbs.)	Load Radius (ft.)	Boom Angle (deg.)	Rated Load (lbs.)	Boom Angle (deg.)	Rated Load (lbs.)	Boom Angle (deg.)	Rated Load (lbs.)	Boom Angle (deg.)	Rated Load (lbs.)
40	79.1	57800*							50	80.5	23800*						
45	77.2	54600*			79.9	42600*			55	78.9	23500*			80.3	14300*		
50	75.2	51600*	79.9	37500*	78.2	41600*			60	77.4	23200*			78.9	14100*		
55	73.2	49000*	77.8	36400*	76.4	40700*			65	75.8	22800*			77.5	13800*		
60	71.2	46700*	75.8	35300*	74.7	39900*	80.9	29500*	70	74.2	22500*			76.0	13600*		
65	69.2	44600*	73.7	34400*	72.9	39000*	79.1	29500*	75	72.6	21800*	80.1	18000*	74.6	13100*		
70	67.1	42700*	71.5	33400*	71.1	37900*	77.3	28300*	80	71.0	21200*	78.5	17600*	73.2	12700*		
75	65.0	41000*	69.3	32500*	69.3	35600*	75.4	27200*	85	69.4	20600*	76.8	17200*	71.7	12200*		
80	62.8	39400*	67.1	31700*	67.4	33500*	73.5	26100*	90	67.7	20000*	75.0	16900*	70.2	11800*	78.9	9600*
85	60.6	37900*	64.8	31000*	65.5	31600*	71.5	25100*	100	64.3	19000*	71.5	16300*	67.2	11100*	75.7	9100*
90	58.3	36600*	62.5	30300*	63.6	29900*	69.5	24200*	110	60.8	18100*	67.8	15800*	64.1	10500*	72.5	8700*
100	53.6	34300*	57.6	28900*	59.7	27100*	65.4	22600*	120	57.1	17300*	64.0	15400*	61.0	9900*	69.2	8400*
110	48.6	32300*	52.3	27600*	55.6	24700*	61.1	21300*	130	53.2	16600*	59.9	14800*	57.7	9400*	65.8	8100*
120	43.0	30400*	46.5	26500*	51.2	22800*	56.5	20200*	140	49.1	16000*	55.6	14100*	54.2	8900*	62.2	7800*
130	36.8	28700*			46.5	21100*	51.5	19300*	150	44.7	15400*	50.8	13500*	50.6	8500*	58.4	7600*
140					41.3	19700*	46.0	18600*	160	39.8	14800*	45.6	13100*	46.7	8200*	54.3	7400*
150					35.4	18600*			170	34.3	14000*			42.5	7900*	49.8	7300*
									180					38.0	7600*	44.8	7200*
									190					32.7	7400*		

120' Boom									120' Boom								
Jib Length	40' Jib				60' Jib				Jib Length	80' Jib				100' Jib			
Offset Angle	10°		30°		10°		30°		Offset Angle	10°		30°		10°		30°	
Load Radius (ft.)	Boom Angle (deg.)	Rated Load (lbs.)	Boom Angle (deg.)	Rated Load (lbs.)	Boom Angle (deg.)	Rated Load (lbs.)	Boom Angle (deg.)	Rated Load (lbs.)	Load Radius (ft.)	Boom Angle (deg.)	Rated Load (lbs.)	Boom Angle (deg.)	Rated Load (lbs.)	Boom Angle (deg.)	Rated Load (lbs.)	Boom Angle (deg.)	Rated Load (lbs.)
40	79.8	59000*							50	81.0	24000*						
45	78.0	55900*			80.5	42900*			55	79.5	23600*			80.7	14400*		
50	76.2	53100*	80.6	37900*	78.8	41900*			60	78.0	23300*			79.4	14100*		
55	74.3	50400*	78.7	36800*	77.2	41100*			65	76.5	23000*			78.0	13900*		
60	72.4	48000*	76.7	35800*	75.5	40200*			70	75.0	22700*			76.7	13600*		
65	70.5	45900*	74.8	34900*	73.9	39400*	79.8	29500*	75	73.5	22200*	80.7	18100*	75.3	13400*		
70	68.6	44000*	72.8	34000*	72.2	38700*	78.0	28900*	80	72.0	21500*	79.1	17700*	74.0	12900*		
75	66.6	42200*	70.8	33100*	70.5	37100*	76.3	27700*	85	70.5	20900*	77.5	17400*	72.6	12500*	80.9	9900*
80	64.7	40700*	68.7	32300*	68.8	34900*	74.5	26600*	90	68.9	20400*	75.9	17000*	71.2	12100*	79.4	9600*
85	62.6	39200*	66.6	31600*	67.0	33000*	72.7	25700*	100	65.7	19400*	72.6	16500*	68.3	11300*	76.5	9200*
90	60.6	37900*	64.5	30900*	65.2	31300*	70.8	24800*	110	62.4	18500*	69.2	16000*	65.4	10700*	73.5	8800*
100	56.3	35600*	60.1	29700*	61.6	28300*	67.0	23200*	120	59.0	17700*	65.6	15500*	62.5	10100*	70.4	8500*
110	51.7	33500*	55.4	28200*	57.8	25900*	63.1	21900*	130	55.4	17000*	61.9	15100*	59.4	9600*	67.1	8200*
120	46.9	31700*	50.3	27100*	53.8	23900*	58.9	20700*	140	51.7	16300*	57.9	14500*	56.2	9200*	63.8	7900*
130	41.5	30000*	44.7	26200*	49.6	22200*	54.5	19800*	150	47.7	15800*	53.7	13900*	52.8	8800*	60.3	7700*
140	35.5	28300*			45.0	20700*	49.7	19000*	160	43.4	15300*	49.1	13300*	49.3	8400*	56.6	7500*
150					40.0	19400*	44.3	18400*	170	38.7	14600*	43.9	12900*	45.5	8100*	52.6	7300*
160					34.3	18400*			180	33.3	13800*			41.4	7800*	48.2	7200*
									190					37.0	7600*	43.3	7100*
									200					31.9	7400*		

* Refer to notes page 9.

CK2500 Jib Rating Loads in Pounds

Refer to notes page 9.

9 Counterweights + 2 Low Weights

130' Boom									130' Boom										
Jib Length		40' Jib				60' Jib				Jib Length		80' Jib				100' Jib			
Offset Angle		10°		30°		10°		30°		Offset Angle		10°		30°		10°		30°	
Load Radius (ft.)	Boom Angle (deg.)	Rated Load (lbs.)	Boom Angle (deg.)	Rated Load (lbs.)	Boom Angle (deg.)	Rated Load (lbs.)	Boom Angle (deg.)	Rated Load (lbs.)	Load Radius (ft.)	Boom Angle (deg.)	Rated Load (lbs.)	Boom Angle (deg.)	Rated Load (lbs.)	Boom Angle (deg.)	Rated Load (lbs.)	Boom Angle (deg.)	Rated Load (lbs.)		
40	80.4	59000*							55	80.0	23700*								
45	78.7	57100*			81.0	43100*			60	78.6	23400*			79.9	14200*				
50	77.0	54300*			79.4	42200*			65	77.2	23100*			78.6	14000*				
55	75.3	51800*	79.4	37200*	77.9	41400*			70	75.8	22800*			77.3	13700*				
60	73.5	49400*	77.6	36300*	76.3	40600*			75	74.3	22500*			76.0	13500*				
65	71.7	47200*	75.7	35300*	74.8	39800*	80.3	29500*	80	72.9	21900*	79.7	17800*	74.7	13100*				
70	69.9	45300*	73.9	34400*	73.2	39000*	78.7	29300*	85	71.4	21300*	78.2	17500*	73.4	12700*				
75	68.1	43500*	72.0	33600*	71.6	38400*	77.1	28200*	90	70.0	20700*	76.6	17200*	72.0	12300*	79.9	9700*		
80	66.3	42000*	70.1	32800*	69.9	36300*	75.4	27100*	100	67.0	19700*	73.5	16600*	69.4	11600*	77.1	9300*		
85	64.4	40500*	68.2	32100*	68.3	34300*	73.7	26200*	110	63.9	18800*	70.3	16100*	66.6	10900*	74.3	8900*		
90	62.5	39200*	66.2	31400*	66.6	32600*	72.0	25300*	120	60.7	18000*	67.0	15700*	63.8	10400*	71.4	8600*		
100	58.5	36700*	62.2	30200*	63.2	29500*	68.5	23700*	130	57.4	17300*	63.5	15300*	60.9	9800*	68.3	8300*		
110	54.4	34700*	57.9	28900*	59.7	27000*	64.8	22400*	140	53.9	16700*	59.9	14800*	57.9	9400*	65.2	8000*		
120	50.0	32800*	53.4	27700*	56.0	24900*	61.0	21200*	150	50.3	16100*	56.1	14200*	54.8	9000*	62.0	7800*		
130	45.3	31100*	48.4	26700*	52.2	23100*	56.9	20300*	160	46.4	15600*	52.0	13600*	51.5	8600*	58.5	7600*		
140	40.2	29700*	43.0	26000*	48.1	21600*	52.6	19400*	170	42.2	15200*	47.5	13200*	48.0	8300*	54.9	7400*		
150	34.3	28000*			43.7	20300*	47.9	18800*	180	37.6	14400*	42.5	12800*	44.4	8000*	51.0	7300*		
160					38.8	19200*	42.7	18200*	190	32.4	13700*			40.4	7700*	46.7	7200*		
170					33.3	18200*			200					31.1	7300*	41.9	7100*		
									210										

140' Boom									140' Boom										
Jib Length		40' Jib				60' Jib				Jib Length		80' Jib				100' Jib			
Offset Angle		10°		30°		10°		30°		Offset Angle		10°		30°		10°		30°	
Load Radius (ft.)	Boom Angle (deg.)	Rated Load (lbs.)	Boom Angle (deg.)	Rated Load (lbs.)	Boom Angle (deg.)	Rated Load (lbs.)	Boom Angle (deg.)	Rated Load (lbs.)	Load Radius (ft.)	Boom Angle (deg.)	Rated Load (lbs.)	Boom Angle (deg.)	Rated Load (lbs.)	Boom Angle (deg.)	Rated Load (lbs.)	Boom Angle (deg.)	Rated Load (lbs.)		
40	81.0	59000*							55	80.5	23800*								
45	79.4	58400*							60	79.1	23500*			80.3	14300*				
50	77.7	55400*			80.0	42500*			65	77.8	23200*			79.1	14000*				
55	76.1	53000*	80.0	37600*	78.5	41600*			70	76.4	22900*			77.8	13800*				
60	74.4	50600*	78.3	36600*	77.0	40900*			75	75.1	22700*			76.6	13600*				
65	72.8	48500*	76.6	35700*	75.5	40100*	80.9	29500*	80	73.7	22200*	80.2	17900*	75.4	13300*				
70	71.1	46600*	74.9	34900*	74.0	39400*	79.3	29500*	85	72.3	21600*	78.8	17600*	74.1	12900*				
75	69.4	44800*	73.1	34100*	72.5	38700*	77.8	28600*	90	70.9	21100*	77.3	17300*	72.8	12500*	80.4	9800*		
80	67.7	43200*	71.3	33300*	71.0	37700*	76.2	27600*	100	68.1	20100*	74.4	16700*	70.3	11800*	77.7	9300*		
85	65.9	41700*	69.6	32600*	69.5	35700*	74.6	26600*	110	65.2	19200*	71.4	16200*	67.7	11100*	75.0	9000*		
90	64.1	40300*	67.7	31900*	67.9	33900*	73.0	25800*	120	62.2	18400*	68.2	15800*	65.0	10600*	72.3	8700*		
100	60.5	37900*	64.0	30700*	64.7	30700*	69.7	24200*	130	59.1	17700*	65.0	15400*	62.2	10100*	69.4	8400*		
110	56.7	35800*	60.1	29600*	61.4	28100*	66.3	22900*	140	55.9	17000*	61.7	15100*	59.4	9600*	66.5	8100*		
120	52.7	33900*	55.9	28300*	58.0	26000*	62.8	21700*	150	52.5	16400*	58.1	14500*	56.5	9200*	63.4	7900*		
130	48.5	32200*	51.6	27300*	54.5	24100*	59.0	20700*	160	49.0	15900*	54.4	13900*	53.5	8800*	60.3	7700*		
140	43.9	30700*	46.8	26400*	50.7	22500*	55.1	19900*	170	45.2	15500*	50.4	13400*	50.3	8500*	56.9	7500*		
150	38.9	29200	41.5	25800*	46.7	21100*	50.9	19200*	180	41.1	15000*	46.0	13000*	46.9	8200*	53.4	7300*		
160	33.3	26400			42.4	19900*	46.4	18600*	190	36.6	14300*	41.1	12700*	43.3	7900*	49.5	7200*		
170					37.7	18900*	41.3	18100*	200	31.5	13600*			39.5	7700*	45.3	7100*		
180					32.3	18100*			210					35.2	7500*	40.6	7100*		
									220					30.3	7300*				

* Refer to notes page 9.

CK2500 Jib Rating Loads in Pounds

Refer to notes page 9.

9 Counterweights + 2 Low Weights

150' Boom									150' Boom										
Jib Length		40' Jib				60' Jib				Jib Length		80' Jib				100' Jib			
Offset Angle		10°		30°		10°		30°		Offset Angle		10°		30°		10°		30°	
Load Radius (ft.)	Boom Angle (deg.)	Rated Load (lbs.)	Boom Angle (deg.)	Rated Load (lbs.)	Boom Angle (deg.)	Rated Load (lbs.)	Boom Angle (deg.)	Rated Load (lbs.)	Load Radius (ft.)	Boom Angle (deg.)	Rated Load (lbs.)	Boom Angle (deg.)	Rated Load (lbs.)	Boom Angle (deg.)	Rated Load (lbs.)	Boom Angle (deg.)	Rated Load (lbs.)		
45	79.9	59000*							55	80.9	23900*								
50	78.4	56600*			80.5	42700*			60	79.6	23600*			80.7	14300*				
55	76.8	54000*	80.5	37900*	79.1	41900*			65	78.3	23300*			79.5	14100*				
60	75.3	51800*	78.9	37000*	77.7	41100*			70	77.1	23000*			78.3	13900*				
65	73.7	49600*	77.3	36100*	76.2	40400*			75	75.8	22800*			77.1	13700*				
70	72.1	47700*	75.7	35300*	74.8	39700*	79.9	29500*	80	74.4	22500*	80.6	18000*	76.0	13500*				
75	70.5	45900*	74.1	34500*	73.4	39000*	78.4	29100*	85	73.1	22000*	79.3	17700*	74.8	13100*				
80	68.9	44300*	72.4	33800*	71.9	38400*	76.9	28000*	90	71.8	21400*	77.9	17400*	73.5	12700*				
85	67.3	42800*	70.7	33100*	70.5	37000*	75.4	27100*	100	69.1	20400*	75.1	16900*	71.1	12000*	78.3	9400*		
90	65.6	41400*	69.0	32400*	69.0	35100*	73.9	26200*	110	66.4	19500*	72.3	16400*	68.6	11400*	75.7	9100*		
100	62.2	39000*	65.5	31200*	66.0	31900*	70.8	24700*	120	63.5	18700*	69.4	15900*	66.1	10800*	73.1	8700*		
110	58.7	36800*	61.9	30100*	62.9	29200*	67.6	23300*	130	60.6	18000*	66.3	15500*	63.5	10300*	70.4	8400*		
120	55.0	35000*	58.2	28900*	59.7	27000*	64.3	22200*	140	57.6	17300*	63.2	15200*	60.8	9800*	67.6	8200*		
130	51.2	33300*	54.2	27800*	56.4	25100*	60.9	21200*	150	54.5	16700*	59.9	14700*	58.1	9400*	64.7	8000*		
140	47.1	31700*	49.9	26900*	53.0	23400*	57.3	20300*	160	51.2	16200*	56.5	14200*	55.2	9000*	61.8	7700*		
150	42.7	28600*	45.3	26200*	49.4	22000*	53.5	19500*	170	47.8	15800*	52.9	13700*	52.2	8700*	58.7	7600*		
160	37.8	25900*	40.2	25600*	45.5	20700*	49.4	18900*	180	44.1	15300*	48.9	13300*	49.1	8400*	55.4	7400*		
170	32.3	23500*			41.3	19700*	45.0	18400*	190	40.1	14800*	44.7	12900*	45.9	8100*	51.9	7300*		
180					36.7	18700*	40.0	18000*	200	35.7	14100*			42.4	7800*	48.2	7200*		
190					31.5	17900*			210	30.7	13500*			38.6	7600*	44.1	7100*		
									220					34.4	7400*				

160' Boom									160' Boom										
Jib Length		40' Jib				60' Jib				Jib Length		80' Jib				100' Jib			
Offset Angle		10°		30°		10°		30°		Offset Angle		10°		30°		10°		30°	
Load Radius (ft.)	Boom Angle (deg.)	Rated Load (lbs.)	Boom Angle (deg.)	Rated Load (lbs.)	Boom Angle (deg.)	Rated Load (lbs.)	Boom Angle (deg.)	Rated Load (lbs.)	Load Radius (ft.)	Boom Angle (deg.)	Rated Load (lbs.)	Boom Angle (deg.)	Rated Load (lbs.)	Boom Angle (deg.)	Rated Load (lbs.)	Boom Angle (deg.)	Rated Load (lbs.)		
45	80.4	59000*							60	80.1	23700*								
50	79.0	57700*			80.9	42900*			65	78.8	23400*			79.9	14200*				
55	77.5	55100*			79.6	42100*			70	77.6	23100*			78.8	13900*				
60	76.0	52800*	79.5	37300*	78.2	41400*			75	76.4	22900*			77.7	13800*				
65	74.6	50800*	78.0	36500*	76.9	40700*			80	75.1	22600*			76.5	13600*				
70	73.1	48900*	76.5	35700*	75.5	40000*	80.4	29500*	85	73.9	22200*	79.8	17800*	75.4	13300*				
75	71.5	47000*	74.9	34900*	74.2	39400*	79.0	29400*	90	72.6	21700*	78.5	17500*	74.2	12900*				
80	70.0	45400*	73.4	34200*	72.8	38700*	77.5	28400*	100	70.0	20700*	75.8	17000*	71.9	12200*	78.8	9500*		
85	68.5	43900*	71.8	33500*	71.4	38100*	76.1	27500*	110	67.4	19800*	73.1	16500*	69.5	11600*	76.3	9100*		
90	66.9	42500*	70.2	32900*	70.0	36300*	74.7	26700*	120	64.7	19000*	70.3	16100*	67.1	11000*	73.8	8800*		
100	63.7	40000*	66.9	31700*	67.2	33000*	71.8	25100*	130	62.0	18300*	67.5	15700*	64.6	10500*	71.3	8500*		
110	60.4	37800*	63.6	30600*	64.3	30300*	68.8	23800*	140	59.2	17700*	64.6	15300*	62.1	10000*	68.6	8300*		
120	57.0	35900*	60.1	29500*	61.3	28000*	65.7	22600*	150	56.2	17100*	61.5	15000*	59.5	9600*	65.9	8000*		
130	53.5	34300*	56.4	28400*	58.2	26000*	62.5	21600*	160	53.2	16500*	58.3	14500*	56.8	9200*	63.1	7800*		
140	49.8	31600*	52.5	27400*	55.0	24300*	59.1	20700*	170	50.0	16000*	55.0	13900*	54.0	8900*	60.2	7600*		
150	45.8	28500*	48.4	26600*	51.6	22800*	55.7	19900*	180	46.7	15600*	51.4	13500*	51.1	8500*	57.2	7500*		
160	41.5	25700*	43.9	26000*	48.1	21500*	52.0	19300*	190	43.1	15200*	47.6	13200*	48.1	8200*	54.0	7300*		
170	36.8	23300*			44.3	20400*	48.0	18700*	200	39.2	14700*	43.4	12800*	44.9	8000*	50.6	7200*		
180	31.4	21100*			40.3	19400*	43.7	18200*	210	34.9	14000*			41.4	7800*	46.9	7100*		
190					35.8	18500*			220	30.0	13400*			37.7	7600*	42.9	7100*		
200					30.7	17800*			230					33.6	7400*				

* Refer to notes page 9.

CK2500 Jib Rating Loads in Pounds

Refer to notes page 9.

9 Counterweights + 2 Low Weights

170' Boom									170' Boom										
Jib Length		40' Jib				60' Jib				Jib Length		80' Jib				100' Jib			
Offset Angle		10°		30°		10°		30°		Offset Angle		10°		30°		10°		30°	
Load Radius (ft.)	Boom Angle (deg.)	Rated Load (lbs.)	Boom Angle (deg.)	Rated Load (lbs.)	Boom Angle (deg.)	Rated Load (lbs.)	Boom Angle (deg.)	Rated Load (lbs.)	Load Radius (ft.)	Boom Angle (deg.)	Rated Load (lbs.)	Boom Angle (deg.)	Rated Load (lbs.)	Boom Angle (deg.)	Rated Load (lbs.)	Boom Angle (deg.)	Rated Load (lbs.)		
45	80.9	59000*							60	80.5	23700*								
50	79.5	58600*							65	79.3	23500*			80.3	14200*				
55	78.1	56100*			80.0	42300*			70	78.1	23200*			79.2	14000*				
60	76.7	53900*	80.0	37600*	78.8	41600*			75	76.9	23000*			78.1	13800*				
65	75.3	51800*	78.6	36800*	77.5	40900*			80	75.7	22700*			77.0	13600*				
70	73.9	49900*	77.2	36000*	76.2	40300*	80.8	29500*	85	74.5	22500*	80.2	17900*	75.9	13400*				
75	72.5	48200*	75.7	35300*	74.9	39700*	79.5	29500*	90	73.3	22000*	79.0	17600*	74.8	13100*				
80	71.0	46400*	74.2	34600*	73.6	39000*	78.1	28800*	100	70.9	21000*	76.4	17100*	72.6	12400*				
85	69.6	45000*	72.7	33900*	72.3	38400*	76.8	27900*	110	68.4	20100*	73.9	16600*	70.3	11800*	76.9	9200*		
90	68.1	43500*	71.2	33300*	70.9	37500*	75.4	27100*	120	65.8	19300*	71.2	16200*	68.0	11200*	74.5	8900*		
100	65.1	41000*	68.2	32100*	68.2	34100*	72.6	25500*	130	63.2	18600*	68.6	15800*	65.6	10700*	72.1	8600*		
110	62.0	38800*	65.0	31000*	65.5	31300*	69.8	24200*	140	60.6	17900*	65.8	15400*	63.2	10200*	69.6	8300*		
120	58.8	36900*	61.7	30100*	62.7	29000*	66.9	23000*	150	57.8	17300*	62.9	15100*	60.7	9800*	67.0	8100*		
130	55.5	34800	58.3	28900*	59.8	26900*	63.9	22000*	160	55.0	16800*	59.9	14700*	58.2	9400*	64.4	7900*		
140	52.1	31100	54.8	27900*	56.8	25200*	60.8	21100*	170	52.0	16300*	56.8	14200*	55.6	9000*	61.6	7700*		
150	48.4	27900	51.0	27100*	53.6	23600*	57.6	20300*	180	48.9	15900*	53.6	13800*	52.9	8700*	58.8	7500*		
160	44.6	25100	47.0	25700	50.4	22300*	54.2	19600*	190	45.6	15500*	50.1	13400*	50.0	8400*	55.8	7400*		
170	40.4	22700	42.7	23100	46.9	21100*	50.5	19000*	200	42.1	15100*	46.3	13000*	47.1	8200*	52.7	7300*		
180	35.8	20600			43.3	20100*	46.7	18500*	210	38.3	14500*	42.3	12800*	43.9	7900*	49.4	7200*		
190	30.6	18700			39.3	19200*	42.5	18100*	220	34.1	13900*			40.6	7700*	45.8	7100*		
200					34.9	17800			230					32.9	7400*	41.8	7100*		
									240										

180' Boom									180' Boom										
Jib Length		40' Jib				60' Jib				Jib Length		80' Jib				100' Jib			
Offset Angle		10°		30°		10°		30°		Offset Angle		10°		30°		10°		30°	
Load Radius (ft.)	Boom Angle (deg.)	Rated Load (lbs.)	Boom Angle (deg.)	Rated Load (lbs.)	Boom Angle (deg.)	Rated Load (lbs.)	Boom Angle (deg.)	Rated Load (lbs.)	Load Radius (ft.)	Boom Angle (deg.)	Rated Load (lbs.)	Boom Angle (deg.)	Rated Load (lbs.)	Boom Angle (deg.)	Rated Load (lbs.)	Boom Angle (deg.)	Rated Load (lbs.)		
50	80.0	59000*							60	80.8	23800*								
55	78.7	57100*			80.4	42500*			65	79.7	23500*			80.7	14300*				
60	77.3	54800*	80.5	37900*	79.2	41800*			70	78.6	23300*			79.6	14100*				
65	76.0	52800*	79.1	37100*	78.0	41200*			75	77.4	23100*			78.6	13900*				
70	74.6	50800*	77.8	36400*	76.8	40500*			80	76.3	22800*			77.5	13700*				
75	73.3	49100*	76.4	35600*	75.5	39900*	79.9	29500*	85	75.1	22600*			76.4	13500*				
80	71.9	47400*	75.0	35000*	74.3	39300*	78.7	29200*	90	74.0	22300*	79.4	17700*	75.4	13300*				
85	70.5	45900*	73.6	34300*	73.0	38800*	77.4	28300*	100	71.7	21300*	77.0	17200*	73.2	12600*	79.6	9600*		
90	69.1	44500*	72.1	33700*	71.8	38200*	76.1	27400*	110	69.3	20400*	74.6	16700*	71.0	11900*	77.4	9200*		
100	66.3	42000*	69.3	32500*	69.2	35200*	73.4	25900*	120	66.8	19600*	72.1	16300*	68.8	11400*	75.1	8900*		
110	63.4	39800*	66.3	31500*	66.6	32400*	70.7	24600*	130	64.4	18900*	69.5	15900*	66.6	10900*	72.8	8700*		
120	60.4	37800*	63.2	30500*	63.9	29900*	68.0	23500*	140	61.8	18200*	66.9	15600*	64.3	10400*	70.4	8400*		
130	57.3	34400	60.1	29400*	61.2	27800*	65.2	22400*	150	59.2	17600*	64.2	15300*	61.9	10000*	68.0	8200*		
140	54.1	30600	56.8	28400*	58.4	26000*	62.3	21500*	160	56.5	17100*	61.4	15000*	59.5	9600*	65.5	8000*		
150	50.8	27500	53.3	27600*	55.4	24400*	59.2	20700*	170	53.8	16600*	58.5	14500*	57.0	9200*	62.9	7800*		
160	47.2	24700	49.7	25300	52.4	23100*	56.1	20000*	180	50.9	16100*	55.4	14000*	54.5	8900*	60.2	7600*		
170	43.5	22300	45.7	22800	49.2	21800*	52.7	19400*	190	47.8	15700*	52.2	13600*	51.8	8600*	57.4	7400*		
180	39.4	20100	41.5	20500	45.8	20800*	49.2	18800*	200	44.6	15400*	48.8	13200*	49.0	8300*	54.5	7300*		
190	34.9	18200			42.3	19100	45.5	18400*	210	41.2	15000*	45.2	12900*	46.1	8100*	51.4	7200*		
200					38.4	17400	41.3	18100	220	37.5	14300*	41.2	12700*	43.0	7800*	48.2	7100*		
210					34.1	15800			230	33.4	13800*			39.8	7600*	44.7	7100*		
									240					36.2	7500*	40.8	7000*		
									250					32.3	7300*				

* Refer to notes page 9.

CK2500 Jib Rating Loads in Pounds

Refer to notes page 9.

9 Counterweights + 2 Low Weights

190' Boom									190' Boom										
Jib Length		40' Jib				60' Jib				Jib Length		80' Jib				100' Jib			
Offset Angle		10°		30°		10°		30°		Offset Angle		10°		30°		10°		30°	
Load Radius (ft.)	Boom Angle (deg.)	Rated Load (lbs.)	Boom Angle (deg.)	Rated Load (lbs.)	Boom Angle (deg.)	Rated Load (lbs.)	Boom Angle (deg.)	Rated Load (lbs.)	Load Radius (ft.)	Boom Angle (deg.)	Rated Load (lbs.)	Boom Angle (deg.)	Rated Load (lbs.)	Boom Angle (deg.)	Rated Load (lbs.)	Boom Angle (deg.)	Rated Load (lbs.)		
50	80.4	59000*							65	80.1	23600*			81.0	14300*				
55	79.2	58000*			80.8	42700*			70	79.0	23400*			80.0	14100*				
60	77.9	55800*	80.9	38100*	79.7	42000*			75	77.9	23100*			79.0	13900*				
65	76.6	53700*	79.6	37400*	78.5	41400*			80	76.8	22900*			77.9	13800*				
70	75.3	51800*	78.3	36600*	77.3	40800*			85	75.7	22700*	81.0	18000*	76.9	13600*				
75	74.0	50000*	77.0	35900*	76.1	40200*	80.4	29500*	90	74.6	22500*	79.8	17700*	75.9	13400*				
80	72.7	48400*	75.7	35300*	74.9	39600*	79.1	29500*	100	72.4	21600*	77.5	17300*	73.8	12700*	80.0	9600*		
85	71.4	46900*	74.3	34600*	73.7	39000*	77.9	28600*	110	70.1	20700*	75.2	16800*	71.7	12100*	77.9	9300*		
90	70.1	45500*	73.0	34000*	72.5	38500*	76.7	27800*	120	67.8	19900*	72.8	16400*	69.6	11500*	75.7	9000*		
100	67.4	42900*	70.2	32900*	70.1	36300*	74.2	26300*	130	65.4	19200*	70.4	16000*	67.4	11000*	73.4	8700*		
110	64.6	40600*	67.4	31800*	67.6	33400*	71.6	25000*	140	63.0	18500*	67.9	15700*	65.2	10600*	71.2	8500*		
120	61.8	38200	64.5	30900*	65.1	30900*	69.0	23800*	150	60.5	17900*	65.3	15400*	63.0	10100*	68.9	8200*		
130	58.9	33800	61.6	30000*	62.5	28700*	66.3	22800*	160	58.0	17300*	62.7	15100*	60.7	9700*	66.5	8000*		
140	55.9	30100	58.5	28900*	59.8	26900*	63.6	21900*	170	55.4	16800*	59.9	14700*	58.3	9400*	64.0	7800*		
150	52.8	26900	55.3	27600	57.0	25200*	60.7	21100*	180	52.6	16400*	57.1	14200*	55.9	9000*	61.5	7700*		
160	49.5	24100	51.9	24800	54.2	23800*	57.8	20300*	190	49.8	16000*	54.1	13800*	53.4	8700*	58.9	7500*		
170	46.1	21700	48.4	22300	51.2	22500*	54.7	19700*	200	46.8	15600*	51.0	13400*	50.8	8500*	56.2	7400*		
180	42.4	19600	44.6	20000	48.1	20400	51.5	19200*	210	43.7	15300*	47.7	13100*	48.1	8200*	53.3	7300*		
190	38.5	17700	40.4	18100	44.8	18500	48.0	18700*	220	40.3	14700*	44.1	12800*	45.2	8000*	50.3	7200*		
200	34.1	16000			41.3	16800	44.3	17600	230	36.7	13400	40.1	12600*	42.2	7800*	47.1	7100*		
210					37.5	15300	40.3	15900	240	32.7	12100*			39.0	7600*	43.6	7000*		
220					33.4	13800			250					35.5	7400*				
									260					31.6	7300*				

200' Boom									200' Boom										
Jib Length		40' Jib				60' Jib				Jib Length		80' Jib				100' Jib			
Offset Angle		10°		30°		10°		30°		Offset Angle		10°		30°		10°		30°	
Load Radius (ft.)	Boom Angle (deg.)	Rated Load (lbs.)	Boom Angle (deg.)	Rated Load (lbs.)	Boom Angle (deg.)	Rated Load (lbs.)	Boom Angle (deg.)	Rated Load (lbs.)	Load Radius (ft.)	Boom Angle (deg.)	Rated Load (lbs.)	Boom Angle (deg.)	Rated Load (lbs.)	Boom Angle (deg.)	Rated Load (lbs.)	Boom Angle (deg.)	Rated Load (lbs.)		
50	80.8	59000*							65	80.5	23700*								
55	79.6	58700*							70	79.4	23500*			80.3	14200*				
60	78.4	56600*			80.1	42200*			75	78.4	23200*			79.3	14000*				
65	77.2	54600*	80.1	37600*	78.9	41600*			80	77.3	23000*			78.4	13800*				
70	76.0	52800*	78.8	36900*	77.8	41000*			85	76.2	22800*			77.4	13600*				
75	74.7	51000*	77.6	36300*	76.7	40400*	80.7	29500*	90	75.2	22600*	80.2	17800*	76.4	13500				
80	73.5	49400*	76.3	35600*	75.5	39800*	79.6	29500*	100	73.0	21800*	78.0	17300*	74.4	12900*	80.4	9700*		
85	72.2	47800*	75.0	35000*	74.4	39300*	78.4	29000*	110	70.8	21000*	75.8	16900*	72.4	12300*	78.3	9300*		
90	71.0	46400*	73.7	34400*	73.2	38700*	77.2	28100*	120	68.6	20200*	73.5	16500*	70.3	11700*	76.2	9000*		
100	68.4	43800*	71.1	33200*	70.9	37300*	74.8	26700*	130	66.4	19400*	71.2	16100*	68.2	11200*	74.1	8800*		
110	65.8	41600*	68.5	32200*	68.5	34300	72.4	25300*	140	64.1	18800*	68.8	15800*	66.1	10700*	71.9	8500*		
120	63.1	38000	65.7	31300*	66.1	31800*	69.9	24200*	150	61.7	18200*	66.3	15500*	64.0	10300*	69.7	8300*		
130	60.4	33600	62.9	30400*	63.6	29600*	67.4	23200*	160	59.3	17600*	63.8	15200*	61.8	9900*	67.4	8100*		
140	57.5	29800	60.1	29400*	61.1	27700*	64.7	22200*	170	56.8	17100*	61.3	14900*	59.5	9500*	65.1	7900*		
150	54.6	26700	57.1	27500*	58.5	26000*	62.1	21400*	180	54.2	16600*	58.6	14400*	57.2	9200*	62.7	7700*		
160	51.6	23900	53.9	24600	55.8	24600*	59.3	20700*	190	51.6	16200*	55.8	14000*	54.9	8900*	60.2	7600*		
170	48.4	21500	50.7	22100	53.0	22300	56.4	20000*	200	48.8	15800*	52.9	13600*	52.4	8600*	57.6	7400*		
180	45.1	19400	47.2	19900	50.1	20200	53.4	19500*	210	45.9	15500*	49.8	13300*	49.8	8400*	55.0	7300*		
190	41.5	17500	43.5	17900	47.1	18200	50.2	19000*	220	42.8	14500	46.6	13000*	47.2	8100*	52.2	7200*		
200	37.6	15800			43.9	16600	46.9	17400	230	39.5	13200	43.1	12800*	44.4	7900*	49.2	7100*		
210	33.3	14100			40.5	15000	43.3	15800	240	36.0	11900			41.4	7700*	46.1	7100*		
220					36.7	13500			250	32.0	10700			38.3	7500*	42.7	7000*		
230					32.6	12100			260					34.8	7400*				
									270					31.0	7300*				

* Refer to notes page 9.

CK2500 Jib Rating Loads in Pounds

Refer to notes page 9.

9 Counterweights + 2 Low Weights

210' Boom									210' Boom										
Jib Length		40' Jib				60' Jib				Jib Length		80' Jib				100' Jib			
Offset Angle		10°		30°		10°		30°		Offset Angle		10°		30°		10°		30°	
Load Radius (ft.)	Boom Angle (deg.)	Rated Load (lbs.)	Boom Angle (deg.)	Rated Load (lbs.)	Boom Angle (deg.)	Rated Load (lbs.)	Boom Angle (deg.)	Rated Load (lbs.)	Load Radius (ft.)	Boom Angle (deg.)	Rated Load (lbs.)	Boom Angle (deg.)	Rated Load (lbs.)	Boom Angle (deg.)	Rated Load (lbs.)	Boom Angle (deg.)	Rated Load (lbs.)		
55	80.0	59000							65	80.8	23800*								
60	78.9	57500*			80.4	42400*			70	79.8	23500*			80.6	14200*				
65	77.7	55400*	80.5	37900*	79.4	41800*			75	78.8	23300*			79.7	14000*				
70	76.5	53600*	79.3	37200*	78.3	41200*			80	77.8	23100*			78.7	13900*				
75	75.3	51800*	78.1	36500*	77.2	40600*			85	76.7	22900*			77.8	13700*				
80	74.2	50300*	76.9	35900*	76.1	40000*	80.0	29500*	90	75.7	22700*	80.6	17900*	76.8	13500*				
85	73.0	48800*	75.7	35300*	75.0	39500*	78.9	29300*	100	73.6	22100*	78.5	17400*	74.9	13100*	80.7	9700*		
90	71.7	47200*	74.4	34700*	73.9	39000*	77.7	28500*	110	71.5	21200*	76.3	17000*	73.0	12500*	78.7	9400*		
100	69.3	44700*	71.9	33600*	71.6	38000*	75.4	27000*	120	69.4	20400*	74.1	16600*	71.0	11900*	76.7	9100*		
110	66.8	42400*	69.4	32600*	69.4	35300*	73.1	25700*	130	67.2	19700*	71.9	16200*	69.0	11400*	74.6	8800*		
120	64.3	37400	66.8	31600*	67.0	32700*	70.7	24500*	140	65.0	19000*	69.6	15900*	67.0	10900*	72.5	8600*		
130	61.7	33000	64.2	30800*	64.7	30500*	68.3	23500*	150	62.8	18400*	67.3	15600*	64.9	10500*	70.4	8400*		
140	59.0	29300	61.4	29800*	62.3	28500*	65.8	22600*	160	60.5	17900*	64.9	15300*	62.8	10100*	68.2	8200*		
150	56.3	26100	58.6	27000	59.8	26800*	63.3	21800*	170	58.1	17300*	62.5	15100*	60.6	9700*	66.0	8000*		
160	53.4	23300	55.7	24100	57.3	24200	60.7	21000*	180	55.7	16900*	60.0	14700*	58.4	9400*	63.7	7800*		
170	50.5	20900	52.7	21600	54.6	21800	58.0	20400*	190	53.2	16400*	57.3	14200*	56.2	9100*	61.4	7600*		
180	47.4	18800	49.5	19300	51.9	19600	55.1	19800*	200	50.6	16000*	54.6	13800*	53.9	8800*	59.0	7500*		
190	44.1	16900	46.1	17300	49.1	17700	52.2	18800*	210	47.9	15400*	51.8	13500*	51.4	8500*	56.5	7400*		
200	40.6	15100	42.4	15600	46.1	16000	49.1	16900	220	45.0	13900	48.8	13200*	48.9	8300*	53.8	7200*		
210	36.8	13400			43.0	14400	45.8	15300	230	42.0	12500	45.6	12900*	46.3	8000*	51.1	7200*		
220	32.6	11900			39.6	12800	42.3	13700	240	38.8	11200	42.1	11900	43.6	7800*	48.2	7100*		
230					36.0	11400			250	35.3	10000			40.7	7600*	45.1	7000*		
240					32.0	10200			260	31.4	8900			37.6	7500*	41.7	7000*		
									270					34.2	7400*				
									280					30.5	7200*				

220' Boom									220' Boom										
Jib Length		40' Jib				60' Jib				Jib Length		80' Jib				100' Jib			
Offset Angle		10°		30°		10°		30°		Offset Angle		10°		30°		10°		30°	
Load Radius (ft.)	Boom Angle (deg.)	Rated Load (lbs.)	Boom Angle (deg.)	Rated Load (lbs.)	Boom Angle (deg.)	Rated Load (lbs.)	Boom Angle (deg.)	Rated Load (lbs.)	Load Radius (ft.)	Boom Angle (deg.)	Rated Load (lbs.)	Boom Angle (deg.)	Rated Load (lbs.)	Boom Angle (deg.)	Rated Load (lbs.)	Boom Angle (deg.)	Rated Load (lbs.)		
55	80.4	59000*							70	80.1	23600*			80.9	14300*				
60	79.3	58200*			80.8	42500*			75	79.2	23400*			80.0	14100*				
65	78.2	56300*	80.9	38100*	79.7	41900*			80	78.2	23100*			79.1	13900*				
70	77.1	54500*	79.7	37400*	78.7	41400*			85	77.2	22900*			78.2	13800*				
75	75.9	52700*	78.6	36800*	77.7	40800*			90	76.2	22700*	80.9	18000*	77.3	13600*				
80	74.8	51100*	77.4	36100*	76.6	40300*	80.4	29500*	100	74.2	22300*	78.9	17500*	75.4	13200*				
85	73.6	49500*	76.2	35500*	75.5	39700*	79.3	29500*	110	72.2	21400*	76.8	17100*	73.5	12600*	79.1	9400*		
90	72.5	48200*	75.1	35000*	74.5	39200*	78.2	28800*	120	70.1	20700*	74.7	16700*	71.6	12000*	77.1	9100*		
100	70.1	45500*	72.7	33900*	72.3	38200*	76.0	27300*	130	68.1	19900*	72.6	16300*	69.7	11500*	75.2	8900*		
110	67.8	42300	70.3	32900*	70.1	36200*	73.8	26000*	140	65.9	19300*	70.4	16000*	67.7	11000*	73.2	8600*		
120	65.3	37000	67.8	32000*	67.9	33600*	71.5	24900*	150	63.8	18700*	68.2	15700*	65.8	10600*	71.1	8400*		
130	62.9	32600	65.3	31100*	65.7	31300*	69.2	23800*	160	61.6	18100*	65.9	15400*	63.7	10200*	69.0	8200*		
140	60.3	28800	62.7	29900	63.4	29300*	66.8	22900*	170	59.3	17600*	63.6	15100*	61.7	9800*	66.9	8000*		
150	57.7	25600	60.0	26600	61.0	26500	64.4	22100*	180	57.0	17100*	61.2	14900*	59.6	9500*	64.7	7800*		
160	55.1	22900	57.3	23700	58.6	23700	61.9	21300*	190	54.7	16700*	58.7	14400*	57.4	9200*	62.5	7700*		
170	52.3	20400	54.5	21200	56.1	21300	59.4	20700*	200	52.2	16300*	56.1	14000*	55.2	8900*	60.2	7500*		
180	49.4	18300	51.5	18900	53.6	19100	56.7	20100*	210	49.6	14900	53.5	13700*	52.9	8600*	57.8	7400*		
190	46.4	16400	48.4	16900	50.9	17200	54.0	18400	220	47.0	13400	50.7	13400*	50.5	8400*	55.3	7300*		
200	43.2	14500	45.0	15100	48.1	15500	51.1	16600	230	44.2	12000	47.7	13000	48.1	8200*	52.8	7200*		
210	39.7	12800	41.5	13300	45.2	13800	48.0	14900	240	41.2	10700	44.6	11500	45.5	8000*	50.1	7100*		
220	36.0	11300			42.1	12300	44.8	13300	250	38.1	9500	41.2	10200	42.8	7800*	47.2	7100*		
230	32.0	10000			38.9	10900	41.3	11700	260	34.6	8400			40.0	7600*	44.2	7000*		
240					35.3	9600			270	30.8	7400			36.9	7400*	40.9	7000*		
250					31.4	8400			280					33.6	7000				
									290					30.0	6100				

* Refer to notes page 9.

CK2500 Jib Rating Loads in Pounds

Refer to notes page 9.

9 Counterweights + 2 Low Weights

230' Boom									230' Boom										
Jib Length		40' Jib				60' Jib				Jib Length		80' Jib				100' Jib			
Offset Angle		10°		30°		10°		30°		Offset Angle		10°		30°		10°		30°	
Load Radius (ft.)	Boom Angle (deg.)	Rated Load (lbs.)	Boom Angle (deg.)	Rated Load (lbs.)	Boom Angle (deg.)	Rated Load (lbs.)	Boom Angle (deg.)	Rated Load (lbs.)	Load Radius (ft.)	Boom Angle (deg.)	Rated Load (lbs.)	Boom Angle (deg.)	Rated Load (lbs.)	Boom Angle (deg.)	Rated Load (lbs.)	Boom Angle (deg.)	Rated Load (lbs.)		
55	80.8	59000							70	80.5	23600*								
60	79.7	58900*							75	79.5	23400*			80.3	14100*				
65	78.6	57000*			80.1	42100*			80	78.6	23200*			79.4	13900*				
70	77.5	55100*	80.1	37600*	79.1	41500*			85	77.6	23000*			78.5	13800*				
75	76.5	53600*	79.0	37000*	78.1	41000*			90	76.7	22800*			77.6	13600*				
80	75.4	51900*	77.9	36400*	77.1	40400*	80.7	29500*	100	74.7	22400*	79.3	17500*	75.8	13300*				
85	74.3	50400*	76.8	35800*	76.0	39900*	79.7	29500*	110	72.8	21700*	77.3	17100*	74.0	12700*	79.5	9500*		
90	73.1	48900*	75.7	35300*	75.0	39400*	78.6	29100*	120	70.8	20900*	75.2	16700*	72.2	12200*	77.6	9200*		
100	70.9	46300*	73.4	34200*	72.9	38500*	76.5	27600*	130	68.8	20200*	73.2	16400*	70.3	11700*	75.7	8900*		
110	68.6	41700	71.1	33200*	70.9	37200*	74.4	26300*	140	66.8	19500*	71.1	16000*	68.5	11200*	73.7	8700*		
120	66.3	36400	68.7	32300*	68.7	34500*	72.2	25200*	150	64.7	18900*	69.0	15800*	66.5	10800*	71.8	8500*		
130	64.0	32000	66.3	31500*	66.6	32200*	70.0	24200*	160	62.6	18400*	66.8	15500*	64.6	10400*	69.8	8300*		
140	61.6	28300	63.9	29400	64.4	29200	67.7	23200*	170	60.5	17800*	64.6	15200*	62.6	10000*	67.7	8100*		
150	59.1	25100	61.3	26100	62.1	26000	65.4	22400*	180	58.3	17300*	62.3	15000*	60.6	9700*	65.6	7900*		
160	56.5	22300	58.7	23200	59.8	23200	63.0	21600*	190	56.0	16900*	60.0	14600*	58.5	9300*	63.5	7700*		
170	53.9	19900	56.1	20600	57.5	20700	60.6	21000*	200	53.7	16000	57.5	14200*	56.4	9100*	61.3	7600*		
180	51.2	17700	53.3	18400	55.0	18600	58.1	20000	210	51.2	14300	55.0	13900*	54.3	8800*	59.0	7500*		
190	48.4	15700	50.4	16400	52.5	16700	55.5	17900	220	48.7	12800	52.4	13500*	52.0	8500*	56.7	7400*		
200	45.4	13800	47.3	14500	49.9	14800	52.8	16100	230	46.1	11300	49.7	12400	49.7	8300*	54.3	7200*		
210	42.3	12100	44.1	12700	47.2	13100	50.0	14400	240	43.4	10000	46.8	11000	47.3	8100*	51.8	7200*		
220	38.9	10600	40.6	11100	44.4	11600	47.0	12700	250	40.5	8800	43.7	9600	44.8	7900*	49.1	7100*		
230	35.3	9200			41.3	10200	43.9	11200	260	37.4	7700	40.3	8400	42.1	7700*	46.3	7000*		
240	31.3	8000			38.1	8900	40.5	9800	270	34.0	6700			39.3	7300	43.3	7000*		
250					34.6	7700			280	30.3	5700			36.3	6400	40.1	7000*		
260					30.8	6700			290					33.0	5500				

240' Boom									240' Boom										
Jib Length		40' Jib				60' Jib				Jib Length		80' Jib				100' Jib			
Offset Angle		10°		30°		10°		30°		Offset Angle		10°		30°		10°		30°	
Load Radius (ft.)	Boom Angle (deg.)	Rated Load (lbs.)	Boom Angle (deg.)	Rated Load (lbs.)	Boom Angle (deg.)	Rated Load (lbs.)	Boom Angle (deg.)	Rated Load (lbs.)	Load Radius (ft.)	Boom Angle (deg.)	Rated Load (lbs.)	Boom Angle (deg.)	Rated Load (lbs.)	Boom Angle (deg.)	Rated Load (lbs.)	Boom Angle (deg.)	Rated Load (lbs.)		
60	80.1	59000*							70	80.8	23700*								
65	79.0	57700*			80.4	42300*			75	79.8	23500*			80.6	14200*				
70	78.0	55900*	80.5	37900*	79.5	41700*			80	78.9	23300*			79.7	14000*				
75	76.9	54200*	79.4	37200*	78.5	41200*			85	78.0	23100*			78.9	13800*				
80	75.9	52700*	78.4	36700*	77.5	40600*			90	77.1	22900*			78.0	13700*				
85	74.8	51100*	77.3	36100*	76.5	40100*	80.0	29500*	100	75.2	22500*	79.6	17600*	76.3	13400*				
90	73.8	49800*	76.2	35500*	75.5	39600*	79.0	29300*	110	73.3	21900*	77.7	17200*	74.5	12900*	79.8	9500*		
100	71.6	47100*	74.0	34500*	73.5	38700*	77.0	27900*	120	71.4	21100*	75.7	16800*	72.7	12300*	78.0	9200*		
110	69.4	41500	71.8	33500*	71.5	37800*	74.9	26600*	130	69.5	20400*	73.8	16500*	70.9	11800*	76.1	9000*		
120	67.2	36200	69.5	32600*	69.5	35300*	72.8	25500*	140	67.6	19700*	71.8	16100*	69.1	11300*	74.2	8700*		
130	65.0	31700	67.2	31800*	67.4	32700	70.7	24500*	150	65.6	19200*	69.7	15800*	67.3	10900*	72.4	8500*		
140	62.7	28000	64.9	29100	65.3	28900	68.5	23500*	160	63.6	18600*	67.6	15600*	65.4	10500*	70.4	8300*		
150	60.3	24800	62.5	25800	63.1	25700	66.3	22700*	170	61.5	18100*	65.5	15300*	63.5	10200*	68.5	8100*		
160	57.9	22000	60.0	22900	60.9	22900	64.1	22000*	180	59.4	17600*	63.3	15100*	61.6	9800*	66.5	8000*		
170	55.4	19600	57.5	20400	58.7	20500	61.8	21300*	190	57.2	17100*	61.1	14800*	59.6	9500*	64.4	7800*		
180	52.9	17400	54.9	18200	56.4	18300	59.4	19800	200	55.0	15700	58.8	14400*	57.6	9200*	62.3	7600*		
190	50.2	15400	52.2	16100	54.0	16400	56.9	17700	210	52.7	14000	56.4	14000*	55.5	8900*	60.2	7500*		
200	47.4	13500	49.3	14200	51.5	14500	54.4	15900	220	50.4	12400	54.0	13700	53.4	8700*	58.0	7400*		
210	44.5	11800	46.3	12400	49.0	12800	51.8	14100	230	47.9	11000	51.4	12100	51.2	8400*	55.7	7300*		
220	41.5	10300	43.2	10800	46.3	11200	49.0	12500	240	45.3	9700	48.7	10700	48.9	8200*	53.3	7200*		
230	38.2	8900			43.5	9800	46.1	10900	250	42.6	8500	45.9	9400	46.5	8000*	50.8	7100*		
240	34.6	7600			40.6	8500	43.0	9500	260	39.8	7400	42.8	8200	44.0	7800*	48.2	7000*		
250	30.7	6500			34.0	6300			270	36.7	6400			41.4	7000	45.4	7000*		
260					30.2	5300			280	33.4	5400			38.7	6000	42.5	6900		
270									290					35.7	5200				
									300					32.5	4300				

* Refer to notes page 9.

CK2500 Jib Rating Loads in Pounds

Refer to notes page 9.

9 Counterweights + 2 Low Weights

250' Boom								250' Boom											
Jib Length		40' Jib				60' Jib				Jib Length		80' Jib				100' Jib			
Offset Angle		10°		30°		10°		30°		Offset Angle		10°		30°		10°		30°	
Load Radius (ft.)	Boom Angle (deg.)	Rated Load (lbs.)	Boom Angle (deg.)	Rated Load (lbs.)	Boom Angle (deg.)	Rated Load (lbs.)	Boom Angle (deg.)	Rated Load (lbs.)	Load Radius (ft.)	Boom Angle (deg.)	Rated Load (lbs.)	Boom Angle (deg.)	Rated Load (lbs.)	Boom Angle (deg.)	Rated Load (lbs.)	Boom Angle (deg.)	Rated Load (lbs.)		
60	80.4	59000*							75	80.2	23500*			80.9	14200*				
65	79.4	58400*			80.8	42400*			80	79.3	23300*			80.0	14000*				
70	78.4	56600*	80.8	38100*	79.8	41800*			85	78.4	23100*			79.2	13900*				
75	77.4	55000*	79.8	37500*	78.9	41300*			90	77.5	22900*			78.4	13700*				
80	76.4	53400*	78.8	36900*	77.9	40800*			100	75.7	22600*	80.0	17700*	76.7	13400*				
85	75.4	51900*	77.7	36300*	77.0	40300*	80.4	29500*	110	73.9	22100*	78.1	17300*	75.0	13000*	80.1	9500*		
90	74.3	50400*	76.7	35800*	76.0	39800*	79.4	29500*	120	72.0	21300*	76.2	16900*	73.3	12500*	78.3	9300*		
100	72.3	47400	74.6	34800*	74.1	38900*	77.4	28200*	130	70.2	20600*	74.3	16600*	71.5	12000*	76.5	9000*		
110	70.2	40900	72.5	33800*	72.1	38000*	75.4	26900*	140	68.3	20000*	72.4	16200*	69.8	11500*	74.7	8800*		
120	68.1	35600	70.3	32900*	70.2	36200*	73.4	25800*	150	66.4	19400*	70.4	15900*	68.0	11100*	72.9	8500*		
130	65.9	31200	68.1	32100*	68.2	32200	71.4	24800*	160	64.4	18800*	68.4	15600*	66.2	10700*	71.1	8400*		
140	63.7	27400	65.9	28700	66.1	28400	69.3	23800*	170	62.5	18300*	66.4	15400*	64.3	10300*	69.2	8200*		
150	61.4	24200	63.6	25300	64.1	25100	67.2	23000*	180	60.4	17800*	64.3	15200*	62.5	9900*	67.2	8000*		
160	59.1	21400	61.2	22400	62.0	22300	65.0	22200*	190	58.4	16900	62.1	15000*	60.6	9600*	65.3	7800*		
170	56.8	19000	58.8	19900	59.8	19900	62.8	21600*	200	56.2	15100	60.0	14600*	58.6	9300*	63.3	7700*		
180	54.4	16700	56.4	17600	57.6	17700	60.6	19300	210	54.1	13400	57.7	14200*	56.6	9100*	61.2	7600*		
190	51.9	14700	53.8	15500	55.4	15700	58.2	17200	220	51.8	11800	55.4	13100	54.6	8800*	59.1	7400*		
200	49.3	12800	51.1	13500	53.0	13800	55.8	15400	230	49.5	10400	53.0	11600	52.5	8500*	56.9	7300*		
210	46.6	11100	48.3	11700	50.6	12100	53.4	13500	240	47.1	9000	50.4	10100	50.3	8300*	54.7	7200*		
220	43.7	9600	45.4	10100	48.1	10500	50.8	11900	250	44.6	7800	47.8	8800	48.1	8100*	52.3	7200*		
230	40.7	8200	42.3	8700	45.5	9100	48.1	10300	260	41.9	6700	45.0	7600	45.8	7300	49.9	7100*		
240	37.5	6900			42.8	7800	45.2	8900	270	39.1	5700	42.0	6500	43.3	6300	47.3	7000*		
250	34.0	5800			39.9	6700	42.1	7600	280	36.1	4800			40.8	5400	44.6	6400		
260	30.1	4500			36.8	5600			290					38.1	4500	41.7	5400		
270					33.4	4600													

* Refer to notes page 9.

SPECIFICATIONS OF PARTS AND ATTACHMENTS

Dimensions: ft-in (mm) – Weight: lbs (kg)

Base Machine

Weight: 99,005 lbs (44,900 kg)

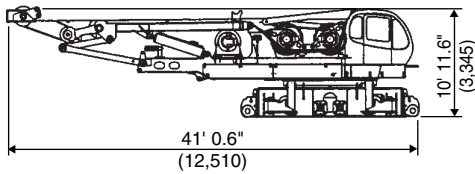

Counterweight (A)

Weight: 27,585 lbs (12,510 kg)

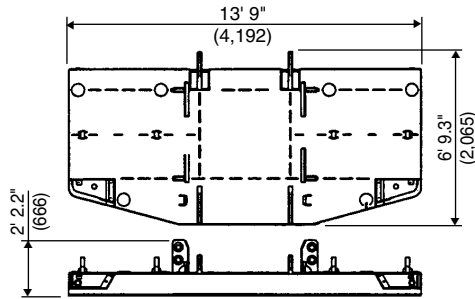

Counterweight (E)

Weight: 8,270 lbs (3,750 kg)

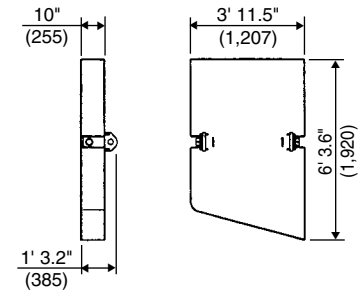

Crawler

Weight: 51,817 lbs (23,500 kg)

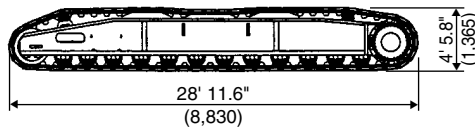

Counterweight (B)

Weight: 22,050 lbs (10,000 kg) - 1 piece

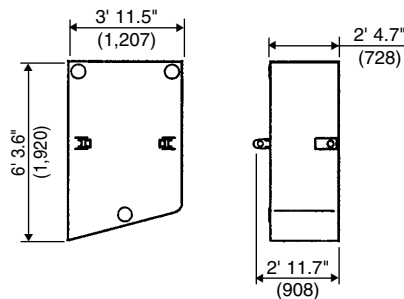

Carbody Weight

Weight: 22,050 lbs (10,000 kg) - 1 piece

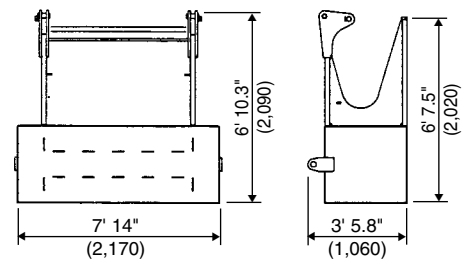

Translifter

Weight: 860 lbs (390 kg)

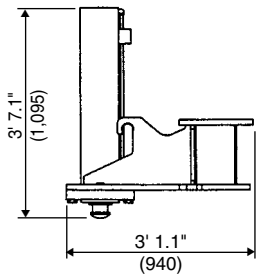

Counterweight (C)

Weight: 22,050 lbs (10,000 kg) - 1 piece

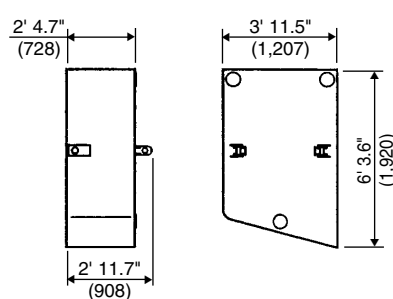

Boom Base

Weight: 7,166 lbs (3,250 kg)

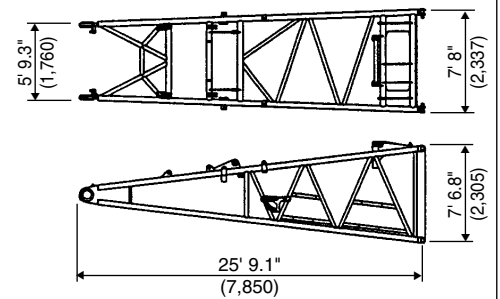

Gantry

Weight: 6,440 lbs (2,920 kg)

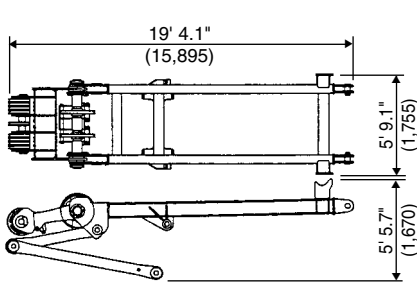

Boom Tip

Weight: 8,813 lbs (3,090 kg)

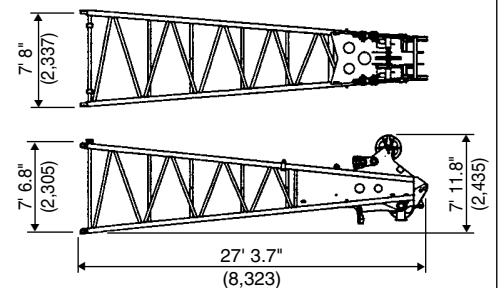

Mast

Weight: 6,550 lbs (2,970 kg)

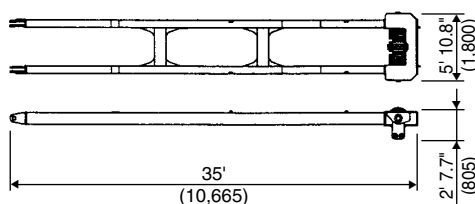

Counterweight (D)

Weight: 8,270 lbs (3,750 kg)

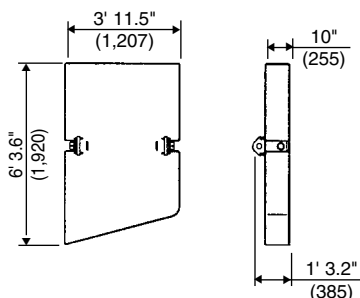

SPECIFICATIONS OF PARTS AND ATTACHMENTS

Dimensions: ft-in (mm) – Weight: lbs (kg)

10 ft (3.0 m) Insert Boom

Weight: 1,632 lbs (740 kg)

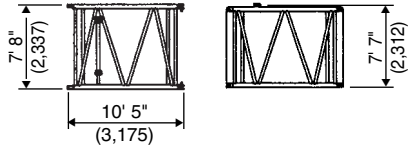

20 ft (6.1 m) Insert Boom

Weight: 2,743 lbs (1,240 kg)

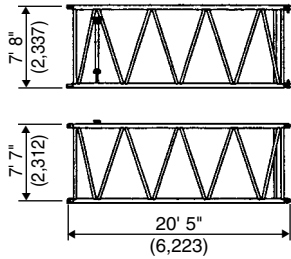

40 ft (9.1 m) Insert Boom

Weight: 4,763 lbs (2,160 kg)

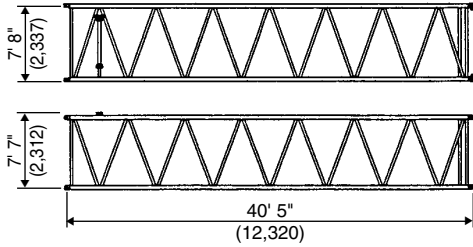

Boom Backstop

Weight: 1,500 (680 kg)

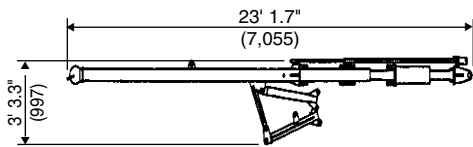

Jib Base (For Crane)

Weight: 463 (210 kg)

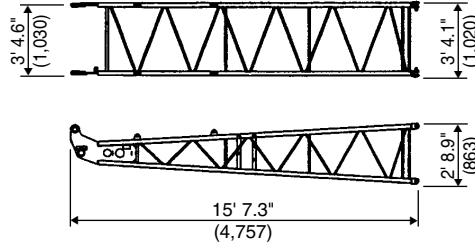

Jib Tip (For Crane)

Weight: 697 lbs (315 kg)

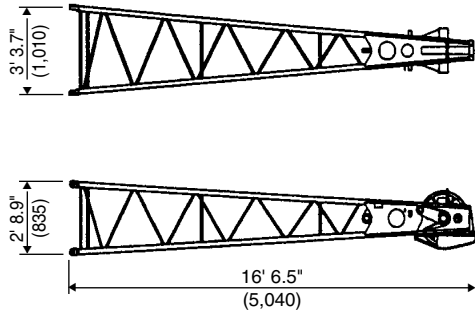

10ft (3.0 m) Insert Jib

Weight: 243 lbs (110 kg)

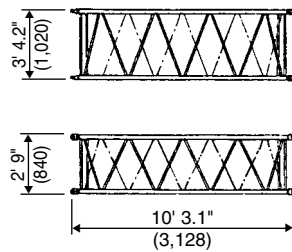

20ft (6.1 m) Insert Jib

Weight: 420 lbs (190 kg)

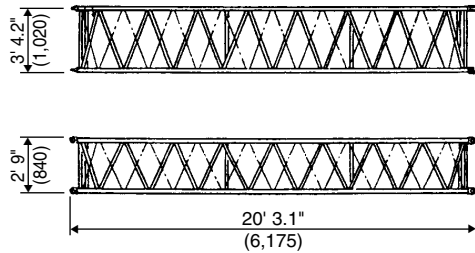

Jib Strut

Weight: 662 lbs (300 kg)

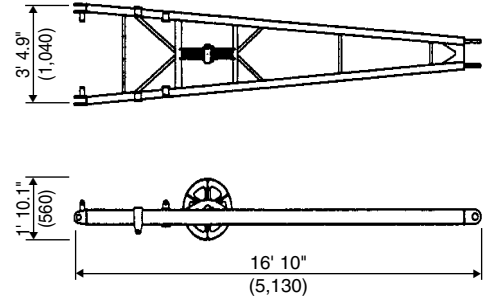

Aux. Sheave

Weight: 610 lbs (276 kg)

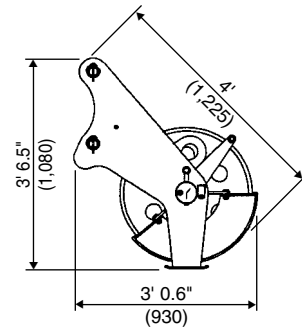

Lower Spreader

Weight: 1,545 lbs (700 kg)

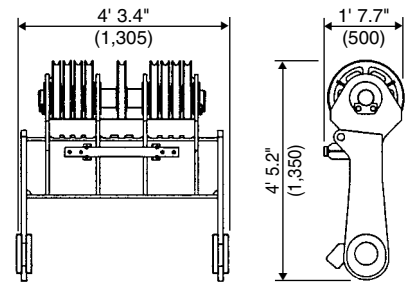

KOBELCO

Your competitive edge.

CK2500

Note: Due to our policy of continual product improvement, all designs and specifications are subject to change without advance notice. Pictures inside this publication may show machines with optional equipment. This manual and the specifications herein were prepared for the market served by Kobelco America Inc. including North America and Latin America. Kobelco product specifications in other world markets may differ.

KOBELCO CONSTRUCTION MACHINERY CO., LTD.

3-13 Nihonbashi 1-chome, Chuo-ku, Tokyo, 103-0027 JAPAN
Tel: ++81 (0) 3-3278-7123 Fax: ++81 (0) 3-3278-7142

KOBELCO AMERICA INC.

12755 South Kirkwood Drive, Stafford, Texas 77477 U.S.A.
Tel: (281) 240-4800 Fax: (281) 240-4906
www.kobelcoamerica.com