

**STANDARD EQUIPMENT**

**ENGINE**

- Engine, HINO J05E-TJ, diesel engine with turbocharger and intercooler
- Automatic engine deceleration
- Batteries (2 x 12V - 96Ah)
- Starting motor (24V - 5 kW), 60 amp alternator
- Automatic engine shut-down for low engine oil pressure
- Engine oil pan drain cock
- Double element air cleaner

**CONTROL**

- Working mode selector (H-mode, S-mode and ECO-mode)
- Power Boost
- Heavy lift

**SWING SYSTEM & TRAVEL SYSTEM**

- Swing rebound prevention system
- Straight propel system
- Two-speed travel with automatic shift down
- Sealed & lubricated track links
- Grease-type track adjusters
- Automatic swing brake

**HYDRAULIC**

- Arm regeneration system
- Auto warm up system
- Aluminum hydraulic oil cooler

**MIRRORS & LIGHTS**

- Three rearview mirrors
- Three front working lights

**CAB & CONTROL**

- Two control levers, pilot-operated
- Tow eyes
- Horn, electric
- Integrated left-right slide-type control box
- Cab light (interior)
- Luggage tray
- Large cup holder
- Detachable two-piece floor mat
- Retractable seatbelt
- Headrest
- Handrails
- Intermittent windshield wiper with double-spray washer
- Skylight
- Tinted safety glass
- Pull-up type front window and removable lower front window
- Easy-to-read multi-display color monitor
- Automatic air conditioner
- Emergency escape hammer
- Suspension seat
- Radio, AM/FM stereo with speaker
- TOP guard

**OPTIONAL EQUIPMENT**

- Wide range of buckets
- Various optional arms
- Wide range of shoes
- Additional track guide
- Object Handling Kit (boom and arm safety valve + hook)
- Additional hydraulic circuit
- Two cab lights
- Air suspension seat
- Rain visor (may interfere with bucket action)

Note: Standard and optional equipment may vary. Consult your KOBELCO dealer for specifics.

Note: This catalog may contain attachments and optional equipment that are not available in your area. And it may contain photographs of machines with specifications that differ from those of machines sold in your areas. Please consult your nearest KOBELCO distributor for those items you require. Specialist equipment is needed to use this machine in demolition work. Before using it please contact your KOBELCO dealer. Due to our policy of continuous product improvements all designs and specifications are subject to change without advance notice. Copyright by **KOBELCO CONSTRUCTION MACHINERY CO., LTD.** No part of this catalog may be reproduced in any manner without notice.

**KOBELCO CONSTRUCTION MACHINERY CO., LTD.**

17-1, Higashigotanda 2-chome, Shinagawa-ku, Tokyo 141-8626 JAPAN  
Tel: +81 (0) 3-5789-2146 Fax: +81 (0) 3-5789-2135  
www.kobelco-kenki.co.jp/english\_index.html

Inquiries To:

Bulletin No. SK210LC/SK260NLC- EU

201311000 Printed in Japan

**SK210<sub>LC</sub>**  
**SK210<sub>NLC</sub>**

- Bucket Capacity:  
**0.8 m<sup>3</sup> ISO heaped**
- Engine Power:  
**117 kW/2,000 min<sup>-1</sup> (ISO 9249)**  
**124 kW/2,000 min<sup>-1</sup> (ISO 14396)**
- Operating Weight:  
**21,200 kg — SK210LC**  
**21,200 kg — SK210NLC**





# EVER IMPROVING FUEL ECONOMY

KOBELCO savings on fuel just keep getting better. The “Three E’s” concept that gave birth to the SK series (Enhancement, Economy, Environment) has been further refined to clear the latest exhaust gas regulations, minimize fuel consumption to incredible new lows, and create a new breed of hydraulic excavator on the cutting edge of performance. The SK210LC/SK210NLC meets increasingly stringent environmental requirements while delivering revolutionary, next-generation operation. To offset the cost of reducing the machine’s environmental impact, we’ve cut running costs in quick response to modern needs. Through our ongoing crusade to cut fuel costs, we continue to create value for our customers, the KOBELCO way.



## Pursuing The “Three E’s”



### Enhancement

- High productivity resulting from lower fuel costs
- New environmental engine and energy-efficient hydraulic circuit improve fuel efficiency

### Economy

- New ECO mode greatly reduces fuel consumption
- Low-maintenance design reduces operating costs
- High structural durability and reliability boost machine resale value

### Environment

- New design achieves low vibration and low noise levels (including improvements in sound quality)



# Reducing Fuel Consumption while Boosting Environmental Performance.

**KOBELCO engineers are constantly seeking better fuel efficiency and cleaner exhaust emissions. To that end, they've combined a newly developed engine with KOBELCO's proprietary energy-efficient system. The result is a machine that opens new frontiers for environmentally responsible operation.**

## New, Environmentally Friendly Engine

**Fuel efficiency**  
(ECO mode, compared with S mode on previous machines)  
About **18%** reduction

The new ECO mode provides a maximum of about 18% reduction in fuel consumption.

**PM Reduction**  
(Compared with previous models)  
About **88%** reduction

Since the adoption of 2006 regulations, PM emissions have been reduced by about 88%, and NOx emissions by about 44%.

## Next-Generation Electronic Engine Control

The new electronic-control common-rail engine features high-pressure fuel injection and multiple injection with improved precision. It is fitted with an EGR cooler, and DP filter which deliver high output from optimized combustion and greatly reduce PM and NOx emissions.



## Energy-Efficient System

### ECO-mode

Work modes for a closer match to the job in hand. An addition to the existing H-mode and S-mode, the new ECO-mode saves even more energy.

### H-mode

For heavy duty when a higher performance level is required.

### S-mode

For normal operations with lower fuel consumption.

### ECO-mode

Puts priority on low fuel consumption and economic performance.

### Fuel Savings in Each Mode

(Compared with previous models)

- H** About **5%** improvement ↓
- S** About **5%** improvement ↓
- E** About **18%** improvement, compared with previous S mode ↓

## Automatic Acceleration/Deceleration Function Reduces Engine Speed

Engine speed is automatically reduced when the control lever is placed in neutral, effectively saving fuel and reducing noise and exhaust emissions. The engine quickly returns to full speed when the lever is moved out of neutral.

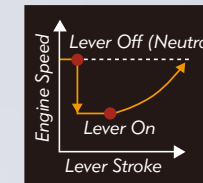

## New Hydraulic System

Rigorous inspections for pressure loss are performed on all components of the hydraulic piping, from the spool of the control valve to the connectors. This regimen, combined with the use of a new, high-efficiency pump, cuts energy loss to a minimum.

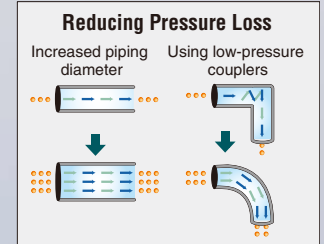

### PM emissions cut:

Limits creation of particulate matter (which results from incomplete combustion of fuel)

#### Common Rail System

High-pressure injection atomizes the fuel, and injection timing is more precise, improving combustion efficiency.



#### VG Turbo

The variable-geometry turbocharger adjusts air intake to maximize combustion efficiency. At low engine speeds the nozzles are closed, the turbo speed increased and air intake is boosted. This helps lower fuel consumption.

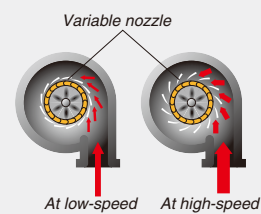

#### Diesel Particulate Filter (DPF)

Carbon builds up as soot on the diesel particulate filter and is burned off at high temperature. At low engine speeds the exhaust temperature is too low, and the common rail multiple injection system is then used to raise the temperature sufficiently to burn off the soot.

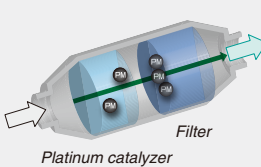

### NOx emissions cut:

Reduces nitrous oxides (created by reaction with oxygen at high temperature)

#### EGR Cooler

While ensuring sufficient oxygen for combustion, cooled emission gases are mixed with the air intake and re-circulated into the engine. The lowered oxygen temperature lowers the combustion temperature and increases combustion efficiency.

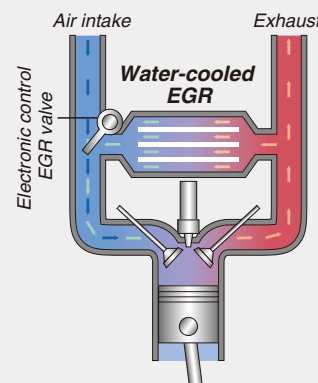

\* Normally, re-circulation occurs automatically. Under certain circumstances, however, it must be done manually using a switch.





# Big Power, Little Fuel for Unbeatable Cost Performance.

**Working Volume Per Unit Fuel**  
 (ECO mode, compared with S mode on previous machines)  
**5% increase**

## Max. Arm Crowding Force

Normal: **102kN {10.4tf}**

With power boost: **112kN {11.4tf}**

## Max. Bucket Digging Force

Normal: **143kN {14.6tf}**

With power boost: **157kN {16.0tf}**

## Top-of-Class Working Ranges

Max. digging reach: **9,900mm**

Max. digging depth: **6,700mm**

Max. vertical wall digging depth: **6,100mm**

\* Values are for HD arm (2.94m)



## Powerful and Smooth Travel and Swing

Thanks to top-of-class travel torque, smooth travel is assured on slopes and uneven terrain, as well as when changing machine direction. Powerful swing torque also ensures smooth swing acceleration and deceleration for more efficient performance.



## Multi-Display Color Monitor for Easy Checking

An LCD multi-display color monitor is fitted as standard. Operations data as well as the full range of machine-status data can readily be checked.

- Analog gauge provides an intuitive reading of fuel level and engine water temperature
- Green indicator light shows low fuel consumption during operation
- Fuel consumption/ Switch indicator for rear camera images
- Digging mode switch
- Monitor display switch

Maintenance Fuel consumption Rearview monitoring Crusher mode Breaker mode

## One-Touch Attachment Mode Switch

A simple flick of a switch converts the hydraulic circuit and flow amount to match attachment changes. Icons help the operator to confirm the proper configuration at a glance.





# Cab Design That Puts the Operator First



## Comfort

### Big Cab

The big cab provides a roomy operating space with plenty of leg-room, and the door opens wide for entry and exit. As well as giving a wide, open view to the front, the cab has increased window areas on both sides and to the rear, for improved visibility in all directions.



### Broad View Liberates the Operator

The front window features one large piece of glass without a center pillar on the right side for a wide, unobstructed view.



### Wide-Access Cab Aids Smooth Entry and Exit

Easy entry and exit assured with wider cab entry and safety lock lever integrated with mounting for control levers.

## Low Vibration

Coil springs absorb small vibrations, and high suspension mounts filled with silicone oil reduce heavy vibration. The long stroke achieved by this system provides excellent protection from vibration.

### Vibration control compared with previous models

- When traveling: about **30%** reduction
- When digging: about **30% to 50%** reduction

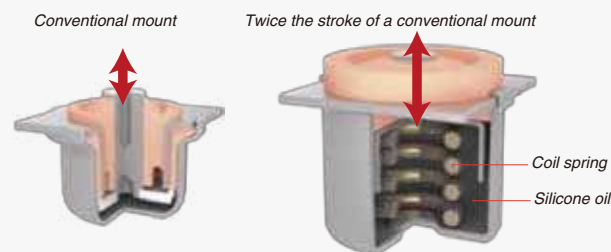

## Safety

### ROPS Cab

The newly developed, ROPS (Roll-Over-Protective Structure)-compliant cab clears ISO standards (ISO-12117-2: 2008) and ensures greater safety for the operator should the machine tip over.



• Level 2 TOP Guard (FOPS Guard) (ISO 10262) is fitted as standard.

- To fit vandalism guards, please contact your KOBELCO dealer (Mounting brackets for vandalism guards)
- Wiper is stored out of sight when not in use to maintain a clear view
- Greater safety assured by rearview mirrors on left and right, and a third mirror mounted at lower right



• Reinforced glass windows meet European standards

### Rear View Camera

A rear view camera is installed as standard to simplify checking for safety behind the machine. The picture appears on the color monitor.

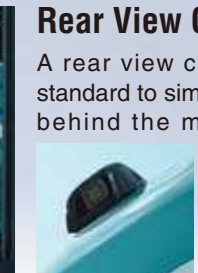

## Safety Features Take Various Scenarios into Consideration



• Hammer for emergency exit



• Retractable seatbelt requires no manual adjustment



• Firewall separates the pump compartment from the engine

- Handrails meet ISO standards
- Thermal guard prevents contact with hot components during engine inspections



# Fast, Accurate and Low-Cost Maintenance

## Monitor Display with Essential Information for Accurate Maintenance Checks



- Displays only the maintenance information that's needed, when it's needed
- Self-diagnostic function provides early-warning detection and display of electrical system malfunctions
- Record function of previous breakdowns including irregular and transient malfunction

	INTERVAL	REMAINING TIME	EXCHANGE DAY
ENGINE OIL	500	497	--/--/--
FUEL FILTER	500	497	--/--/--
HYD. FILTER	1000	997	--/--/--
HYD. OIL	5000	4997	--/--/--

## Comfortable "On the Ground" Maintenance

Most daily inspection and regular maintenance tasks can be easily implemented with ready access on the ground.



**Double-element air cleaner**  
The large-capacity element features a double-filter structure that keeps the engine running clean even in dusty environments.



**Pre-fuel filter (built-in water separator)**  
The large capacity fuel filter is designed specially for common rail engines. This high-grade filter catches 95% of all dust particles and other impurities in the fuel.



Engine oil filter



Refueling pump



## Maintenance Carried Out on Top of the Machine Is Safety-Oriented

Three steps are provided for climbing the machine, with handrails that meet ISO standards, so that maintenance can be safely carried out on top of the machine.



Handrails



Three steps

## More Efficient Maintenance Inside the Cab



**Easy-access fuse box**  
More finely differentiated fuses make it easier to locate malfunctions.



**DPF reactivation switch**  
If the monitor warning goes off, the filter should be reactivated manually using a switch.



**Hour meter**  
Hour meter can be checked while standing on the ground.



**Air conditioner filters**  
Internal and external air conditioner filters can be easily removed without tools for cleaning.

## Easy Cleaning



**Crawler frame**  
Special crawler frame design is easily cleaned of mud.

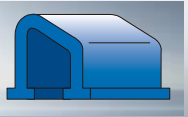

**Detachable two-piece floor mat**  
Detachable two-piece floor mat with handles for easy removal. A floor drain is located under floor mat.

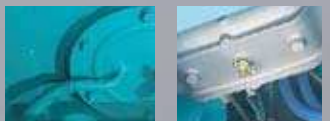

**Fuel tank**  
Fuel tank equipped with bottom flange and large drain valve.

## Emergency Acceleration Feature



In the unlikely event of an ITCS control system malfunction, the emergency acceleration feature enables the operator to control the engine directly. The machine's backup system automatically switches to emergency operation mode.

## Long-Interval Maintenance

Long-life hydraulic oil reduces cost and labor.

Long-life hydraulic oil:  
**5,000**  
hours

## Highly Durable Super-fine Filter

The high-capacity hydraulic oil filter incorporates glass fiber with superior cleaning power and durability.

Replacement cycle:  
**1,000**  
hours





## Engine

Model	HINO J05E-TJ
Type	Direct injection, water-cooled, 4-cycle diesel engine with turbocharger, intercooler
No. of cylinders	4
Bore and stroke	112 mm x 130 mm
Displacement	5.123 L
Rated power output	117 kW/2,000 min <sup>-1</sup> (ISO 9249) 124 kW/2,000 min <sup>-1</sup> (ISO 14396)
Max. torque	640 N-m/1,600 min <sup>-1</sup> (ISO 9249) 660 N-m/1,600 min <sup>-1</sup> (ISO 14396)

## Hydraulic System

Pump	
Type	Two variable displacement pumps + one gear pump
Max. discharge flow	2 x 220 L/min, 1 x 20 L/min
Relief valve setting	
Boom, arm and bucket	34.3 MPa {350 kgf/cm <sup>2</sup> }
Power Boost	37.8 MPa {385 kgf/cm <sup>2</sup> }
Travel circuit	34.3 MPa {350 kgf/cm <sup>2</sup> }
Swing circuit	29.0 MPa {296 kgf/cm <sup>2</sup> }
Control circuit	5.0 MPa {50 kgf/cm <sup>2</sup> }
Pilot control pump	Gear type
Main control valve	8-spool
Oil cooler	Air cooled type

## Swing System

Swing motor	Axial piston motor
Brake	Hydraulic; locking automatically when the swing control lever is in neutral position
Parking brake	Oil disc brake, hydraulic operated automatically
Swing speed	12.5 min <sup>-1</sup> {rpm}
Tail swing radius	2,860 mm
Min. front swing radius	3,540 mm

## Attachments

Backhoe bucket and combination

Use	Backhoe bucket				
		Normal digging		Light-duty	
Bucket capacity	ISO heaped m <sup>3</sup>	0.7	0.8	0.93	1.05
	Struck m <sup>3</sup>	0.52	0.59	0.67	0.75
Opening width	With side cutter mm	1,080	1,160	1,330	1,460
	Without side cutter mm	980	1,060	1,230	1,360
No. of teeth		5	5	5	5
Bucket weight	kg	630	660	710	770
Combination	2.4 m short arm	○	○	◎	△
	2.94 m standard arm	○	◎	○	×
	3.5 m long arm	◎	△	×	×

◎ Standard ○ Recommended △ Loading only × Not recommended

## Travel System

Travel motors	2 x axial-piston, two-step motors
Travel brakes	Hydraulic brake per motor
Parking brakes	Oil disc brake per motor
Travel shoes	49 each side
Travel speed	6.0/3.6 km/h
Drawbar pulling force	229 kN (ISO 7464)
Gradeability	70 % {35°}

## Cab & Control

Cab	
All-weather, sound-suppressed steel cab mounted on the high suspension mounts filled with silicone oil and equipped with a heavy, insulated floor mat.	
Control	
Two hand levers and two foot pedals for travel	
Two hand levers for excavating and swing	
Electric rotary-type engine throttle	

## Boom, Arm & Bucket

Boom cylinders	125 mm x 1,320mm
Arm cylinder	135 mm x 1,588 mm
Bucket cylinder	120 mm x 1,080 mm

## Refilling Capacities & Lubrications

Fuel tank	370 L
Cooling system	23 L
Engine oil	20.5 L
Travel reduction gear	2 x 5.0 L
Swing reduction gear	3.0 L
Hydraulic oil tank	130 L tank oil level 230 L hydraulic system

## Working Ranges

Range	Arm	5.65 m		
		Short 2.4 m	Standard 2.94 m	Long 3.5 m
a- Max. digging reach		9.42	9.9	10.34
b- Max. digging reach at ground level		9.24	9.73	10.17
c- Max. digging depth		6.16	6.7	7.26
d- Max. digging height		9.51	9.72	9.75
e- Max. dumping clearance		6.68	6.91	6.97
f- Min. dumping clearance		2.98	2.43	1.87
g- Max. vertical wall digging depth		5.57	6.1	6.47
h- Min. swing radius		3.56	3.54	3.48
i- Horizontal digging stroke at ground level		4.08	5.27	6.08
j- Digging depth for 2.4 m (8') flat bottom		5.95	6.52	7.08
Bucket capacity ISO heaped m <sup>3</sup>		0.93	0.8	0.7

Unit: m

Digging Force (ISO 6015)			
Arm length	Unit: kN		
	Short 2.4 m	Standard 2.94 m	Long 3.5 m
Bucket digging force	143 157*	143 157*	143 157*
Arm crowding force	121 133*	102 112*	91.8 101*

\*Power Boost engaged.

## Dimensions

Arm length	Unit: mm		
	Short 2.4 m	Standard 2.94 m	Long 3.5 m
A Overall length	9,640	9,560	9,630
B Overall height (to top of boom)	3,150	2,980	3,170
C Overall width of crawler	SK210LC	2,990	
	SK210NLC	2,800	
D Overall height (to top of cab)	3,070		
E Ground clearance of rear end*	1,060		
F Ground clearance*	450		
G Tail swing radius	2,860		

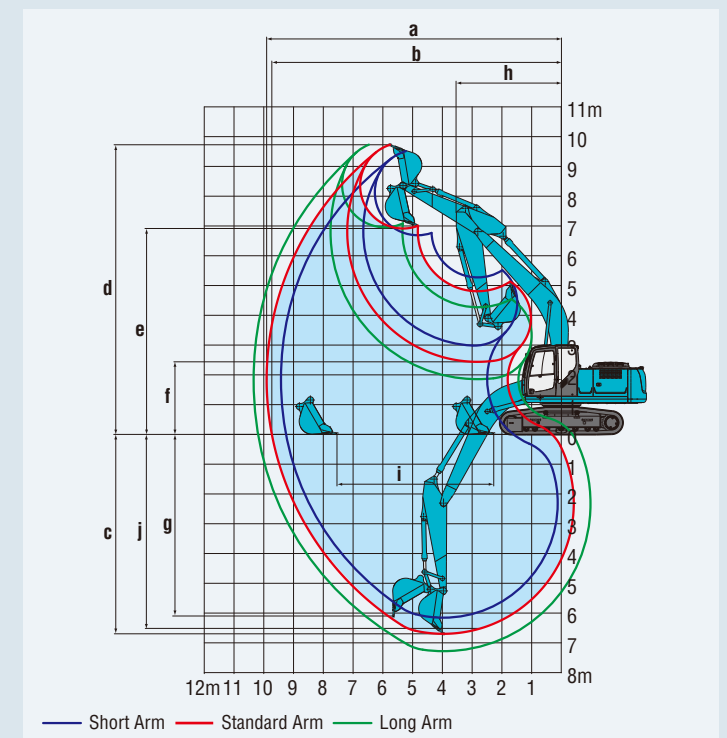

Unit: mm		
G' Distance from center of swing to rear end		2,860
H Tumbler distance	SK210LC	3,660
	SK210NLC	3,660
I Overall length of crawler	SK210LC	4,450
	SK210NLC	4,450
J Track gauge	SK210LC	2,390
	SK210NLC	2,200
K Shoe width		600
L Overall width of upperstructure		2,710

\*Without including height of shoe

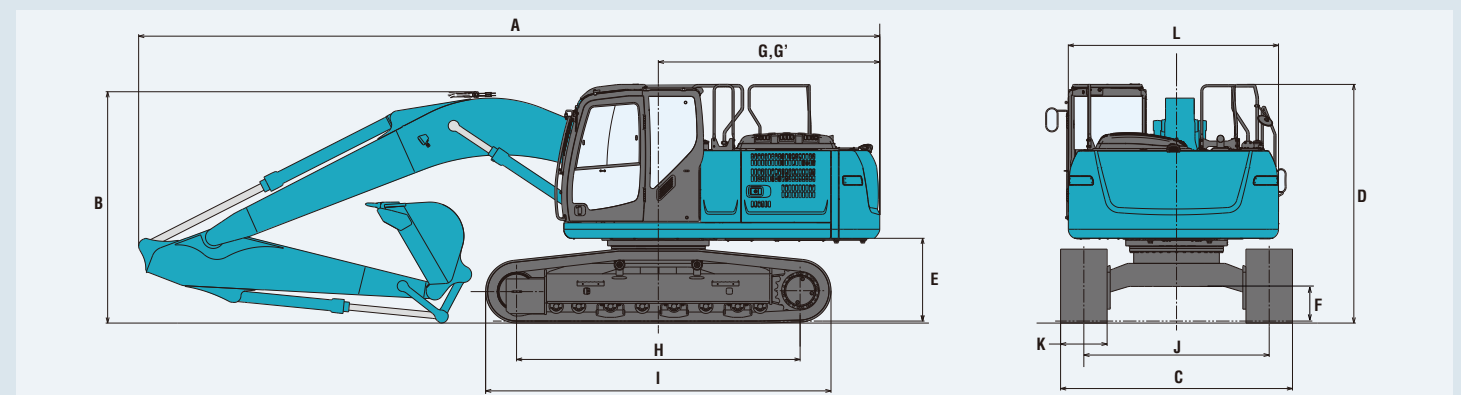

## Operating Weight & Ground Pressure

In standard trim, with standard boom, 2.94 m arm, and 0.8 m<sup>3</sup> ISO heaped bucket

Shaped	Shoe width	Triple grouser shoes (even height)			
		600	700	790	900
Overall width of crawler	SK210LC	2,990	3,090	3,180	3,290
	SK210NLC	2,800	—	—	—
Ground pressure	SK210LC	44	39	34	31
	SK210NLC	44	—	—	—
Operating weight	SK210LC	21,200	21,700	21,900	22,200
	SK210NLC	21,200	—	—	—

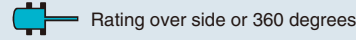
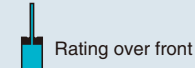
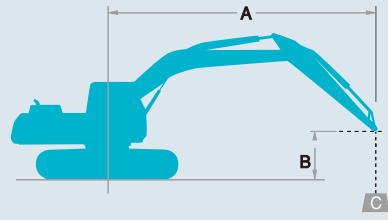

A: Reach from swing centerline to arm top  
 B: Arm top height above/below ground  
 C: Lifting capacities in Kilograms  
 Bucket: Without bucket  
 Relief valve setting: 37.8 MPa (385 kgf/cm<sup>2</sup>)

SK210LC		Boom: 5.65 m Arm: 2.94 m, Bucket: without Shoe: 600 mm (Heavy Lift)														
B	A	1.5 m		3.0 m		4.5 m		6.0 m		7.5 m		At Max. Reach		Radius		
		Rating over front	Rating over side or 360 degrees	Rating over front	Rating over side or 360 degrees	Rating over front	Rating over side or 360 degrees	Rating over front	Rating over side or 360 degrees	Rating over front	Rating over side or 360 degrees	Rating over front	Rating over side or 360 degrees			
7.5 m	kg											*5,350	*5,350	*4,320	*4,320	6.26 m
6.0 m	kg											*5,990	5,430	*4,000	3,840	7.36 m
4.5 m	kg											*6,540	5,250	5,630	3,680	8.03 m
3.0 m	kg													*9,510	7,620	8.38 m
1.5 m	kg													*11,220	7,070	8.45 m
G.L.	kg															
-1.5 m	kg	*6,750	*6,750	*11,110	*11,110	11,440	6,700	7,210	4,470	5,230	3,330	5,000	3,190	7.75 m		
-3.0 m	kg	*11,780	*11,780	*14,890	13,160	*10,730	6,770	7,260	4,510			5,970	3,780	6.89 m		
-4.5 m	kg			*11,080	*11,080	*8,120	7,010					*6,120	5,310	5.50 m		

SK210NLC		Boom: 5.65 m Arm: 2.94 m, Bucket: without Shoe: 600 mm (Heavy Lift)														
B	A	1.5 m		3.0 m		4.5 m		6.0 m		7.5 m		At Max. Reach		Radius		
		Rating over front	Rating over side or 360 degrees	Rating over front	Rating over side or 360 degrees	Rating over front	Rating over side or 360 degrees	Rating over front	Rating over side or 360 degrees	Rating over front	Rating over side or 360 degrees	Rating over front	Rating over side or 360 degrees			
7.5 m	kg													*5,350	5,020	6.26 m
6.0 m	kg													*5,990	5,010	7.36 m
4.5 m	kg													*6,540	4,840	8.03 m
3.0 m	kg															8.38 m
1.5 m	kg													*9,510	6,950	8.45 m
G.L.	kg															
-1.5 m	kg	*6,750	*6,750	*11,110	*11,110	11,420	6,050	7,200	4,070	5,220	3,040	4,990	2,920	7.75 m		
-3.0 m	kg	*11,780	*11,780	*14,890	11,650	*10,730	6,120	7,250	4,110			5,950	3,460	6.89 m		
-4.5 m	kg			*11,080	*11,080	*8,120	6,360					*6,120	4,850	5.50 m		

SK210LC		Boom: 5.65 m Arm: 3.5 m, Bucket: without Shoe: 600 mm (Heavy Lift)														
B	A	1.5 m		3.0 m		4.5 m		6.0 m		7.5 m		At Max. Reach		Radius		
		Rating over front	Rating over side or 360 degrees	Rating over front	Rating over side or 360 degrees	Rating over front	Rating over side or 360 degrees	Rating over front	Rating over side or 360 degrees	Rating over front	Rating over side or 360 degrees	Rating over front	Rating over side or 360 degrees			
7.5 m	kg													*3,680	*3,680	6.84 m
6.0 m	kg													*4,580	3,740	7.86 m
4.5 m	kg													*5,890	5,270	8.49 m
3.0 m	kg															8.82 m
1.5 m	kg															8.89 m
G.L.	kg															
-1.5 m	kg	*6,600	*6,600	*10,990	*10,990	11,240	6,500	7,060	4,320	5,080	3,180	4,470	2,810	8.22 m		
-3.0 m	kg	*10,510	*10,510	*15,930	12,720	*11,080	6,520	7,060	4,310			5,200	3,260	7.42 m		
-4.5 m	kg	*15,610	*15,610	*12,790	*12,790	*9,160	6,700	*6,480	4,470			*6,170	4,320	6.16 m		

SK210NLC		Boom: 5.65 m Arm: 3.5 m, Bucket: without Shoe: 600 mm (Heavy Lift)														
B	A	1.5 m		3.0 m		4.5 m		6.0 m		7.5 m		At Max. Reach		Radius		
		Rating over front	Rating over side or 360 degrees	Rating over front	Rating over side or 360 degrees	Rating over front	Rating over side or 360 degrees	Rating over front	Rating over side or 360 degrees	Rating over front	Rating over side or 360 degrees	Rating over front	Rating over side or 360 degrees			
7.5 m	kg															6.84 m
6.0 m	kg															7.86 m
4.5 m	kg													*5,890	4,850	8.49 m
3.0 m	kg															8.82 m
1.5 m	kg															8.89 m
G.L.	kg															
-1.5 m	kg	*6,600	*6,600	*10,990	*10,990	11,220	5,860	7,050	3,920	5,070	2,890	4,460	2,550	8.22 m		
-3.0 m	kg	*10,510	*10,510	*15,930	11,220	*11,080	5,880	7,040	3,920			5,190	2,960	7.42 m		
-4.5 m	kg	*15,610	*15,610	*12,790	11,570	*9,160	6,060	*6,480	4,070			*6,170	3,940	6.16 m		

SK210LC		Boom: 5.65 m Arm: 2.4 m, Bucket: without Shoe: 600 mm (Heavy Lift)										
B	A	3.0 m		4.5 m		6.0 m		7.5 m		At Max. Reach		Radius
		Rating over front	Rating over side or 360 degrees	Rating over front	Rating over side or 360 degrees	Rating over front	Rating over side or 360 degrees	Rating over front	Rating over side or 360 degrees	Rating over front	Rating over side or 360 degrees	
7.5 m	kg											5.58 m
6.0 m	kg											6.80 m
4.5 m	kg											7.52 m
3.0 m	kg											7.89 m
1.5 m	kg											7.97 m
G.L.	kg											7.75 m
-1.5 m	kg	*11,480	*11,480	11,490	6,740	7,250	4,510			5,580	3,560	7.22 m
-3.0 m	kg	*13,370	13,360	*10,040	6,870	*7,320	4,620			*6,710	4,360	6.29 m
-4.5 m	kg			*6,370	*6,370					*5,830	*5,830	4.72 m

SK210NLC		Boom: 5.65 m Arm: 2.4 m, Bucket: without Shoe: 600 mm (Heavy Lift)										
B	A	3.0 m		4.5 m		6.0 m		7.5 m		At Max. Reach		Radius
		Rating over front	Rating over side or 360 degrees	Rating over front	Rating over side or 360 degrees	Rating over front	Rating over side or 360 degrees	Rating over front	Rating over side or 360 degrees	Rating over front	Rating over side or 360 degrees	
7.5 m	kg											5.58 m
6.0 m	kg											6.80 m
4.5 m	kg											7.52 m
3.0 m	kg											7.89 m
1.5 m	kg											7.97 m
G.L.	kg											7.75 m
-1.5 m	kg	*11,480	*11,480	11,470	6,100	7,240	4,110			5,570	3,260	7.22 m
-3.0 m	kg	*13,370	11,840	*10,040	6,220	*7,320	4,210			*6,710	3,990	6.29 m
-4.5 m	kg			*6,370	*6,370					*5,830	*5,830	4.72 m

- Notes:**
- Do not attempt to lift or hold any load that is greater than these lift capacities at their specified lift point radius and heights. Weight of all accessories must be deducted from the above lift capacities.
  - Lift capacities are based on machine standing on level, firm, and uniform ground. User must make allowance for job conditions such as soft or uneven ground, out of level conditions, side loads, sudden stopping of loads, hazardous conditions, experience of personnel, etc.
  - Arm top defined as lift point.

- The above lifting capacities are in compliance with ISO 10567. They do not exceed 87% of hydraulic lifting capacity or 75% of tipping load. Lifting capacities marked with an asterisk (\*) are limited by hydraulic capacity rather than tipping load.
- Operator should be fully acquainted with the Operator's and Maintenance Instructions before operating this machine. Rules for safe operation of equipment should be adhered to at all times.
- Lift capacities apply to only machine as originally manufactured and normally equipped by KOBELCO CONSTRUCTION MACHINERY CO., LTD.