

## BOOM AND JIB ARRANGEMENTS

### Heavy Duty Crane Boom Arrangements

Boom length m (ft)	Boom arrangement
24 (79)	
30 (98)	※ 
36 (117)	※
42 (138)	※ 
48 (157)	※
54 (177)	※ 
60 (197)	※
66 (217)	※ 
72 (236)	※
78 (256)	※ 
84 (276)	※

Symbol	Boom Length	Remarks
	9.0 m (29.5 ft)	Boom Base
	8.0 m (26.2 ft)	Tapered Boom
	6.0 m (19.7 ft)	Insert Boom
	12.0 m (39.4 ft)	Insert Boom
	1.0 m (3.3 ft)	Boom Top

※ indicates the most flexible combination of insert heavy duty booms, which can be modified to form all shorter heavy duty boom arrangements.

### Luffing Boom Arrangements for Crane

Boom length m (ft)	Boom arrangement
30 (98)	※ 
36 (118)	※
42 (138)	※ 
48 (157)	※
54 (177)	※ 
60 (197)	※
66 (217)	※ 
72 (236)	※
78 (256)	※ 
84 (276)	※

Symbol	Boom Length	Remarks
	9.0 m (29.5 ft)	Boom Base
	8.0 m (26.2 ft)	Tapered Boom
	6.0 m (19.7 ft)	Insert Boom
	12.0 m (39.4 ft)	Insert Boom
	1.0 m (3.3 ft)	Boom Top

※ indicates the most flexible combination of insert luffing booms, which can be modified to form all shorter luffing boom arrangements.

### Long Boom Arrangements





Boom length m (ft)	Boom arrangement
90 (295)	
96 (315)	※ 
102 (335)	※   
108 (354)	※ 

Symbol	Boom Length	Remarks
	9.0 m (29.5 ft)	Boom Base
	8.0 m (26.2 ft)	Tapered Boom
	6.0 m (19.7 ft)	Insert Boom
	12.0 m (39.4 ft)	Insert Boom
	5.0 m (16.4 ft)	Luffing Insert Jib
	6.0 m (19.7 ft)	Luffing Insert Jib
	12.0 m (39.4 ft)	Luffing Insert Jib
	8.0 m (26.2 ft)	Jib Top

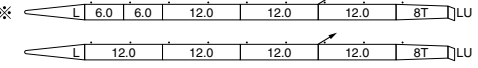
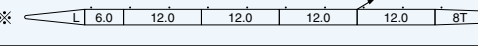
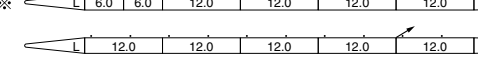
※ indicates the most flexible combination of insert long booms, which can be modified to form all shorter long boom arrangements.

## Heavy Fixed Jib Boom Arrangements





Boom length m (ft)	Boom arrangement
66 (217)	※ 
72 (236)	※ 
78 (256)	※ 

Symbol	Boom Length	Remarks
	9.0 m (29.5 ft)	Boom Base
	8.0 m (26.2 ft)	Tapered Boom
	6.0 m (19.7 ft)	Insert Boom
	12.0 m (39.4 ft)	Insert Boom
	1.0 m (3.3 ft)	Boom Top

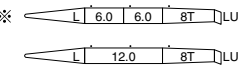
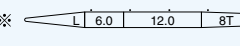
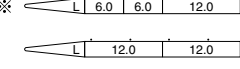
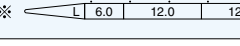
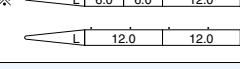
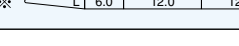
↗ mark shows the guy line installing position when the fixed jib is used.  
 ※ indicates the most flexible combination of insert luffing booms, which can be modified to form all shorter luffing boom arrangements.

## Luffing Boom Arrangements for Luffing



Boom length m (ft)	Boom arrangement
30 (98)	※ 
36 (118)	※ 
42 (138)	※ 
48 (157)	※ 
54 (177)	※ 
60 (197)	※ 

Symbol	Boom Length	Remarks
	9.0 m (29.5 ft)	Boom Base
	8.0 m (26.2 ft)	Tapered Boom
	6.0 m (19.7 ft)	Insert Boom
	12.0 m (39.4 ft)	Insert Boom
	1.0 m (3.3 ft)	Boom Top

※ indicates the most flexible combination of insert luffing booms, which can be modified to form all shorter luffing boom arrangements.





## Heavy Fixed Jib Arrangements

Jib length m (ft)	Jib arrangement
18 (59)	

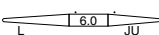
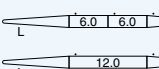
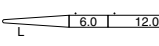
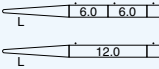
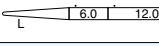
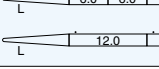
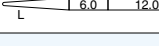
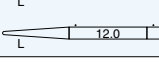
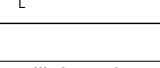
Symbol	Jib Length	Remarks
	10.0 m (32.8 ft)	Jib Base
	8.0 m (26.2 ft)	Jib Top

## Luffing Jib Arrangements

Jib length m (ft)	Jib arrangement
24 (79)	
30 (98)	※ 
36 (118)	※ 
42 (138)	※ 
48 (157)	※ 
54 (177)	※ 
60 (197)	※ 
66 (217)	※ 
72 (236)	※ 

Symbol	Jib Length	Remarks
	10.0 m (32.8 ft)	Jib Base
	6.0 m (19.7 ft)	Luffing Insert Jib
	12.0 m (39.4 ft)	Luffing Insert Jib
	8.0 m (26.2 ft)	Jib Top

※ indicates the most flexible combination of insert luffing jibs, which can be modified to form all shorter luffing jib arrangements.

## WORKING RANGES

### Heavy Duty Crane Boom

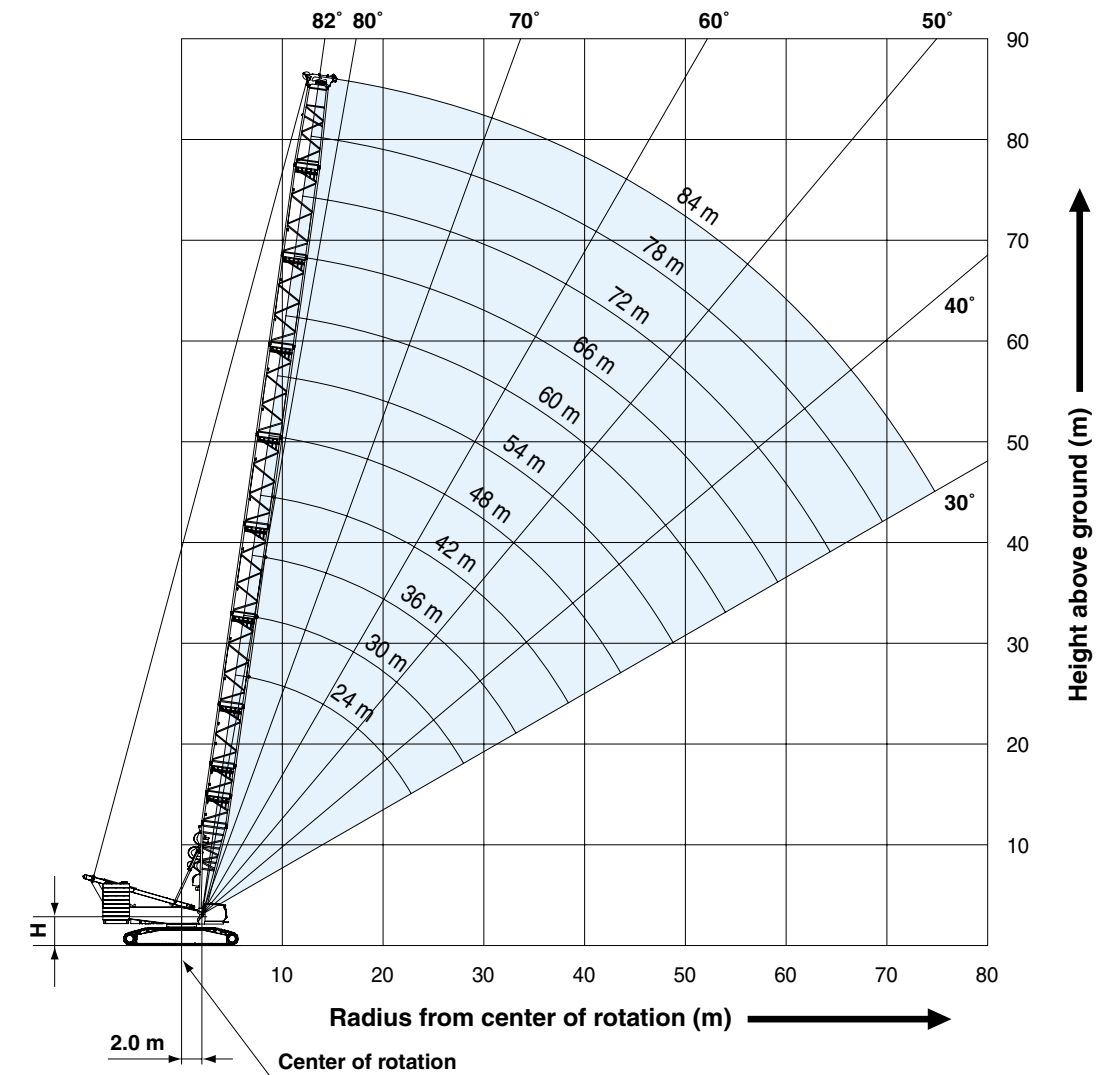

H=2.86 m Without quick connection ring  
 H=3.08 m With quick connection ring

## WORKING RANGES

### Luffing Boom

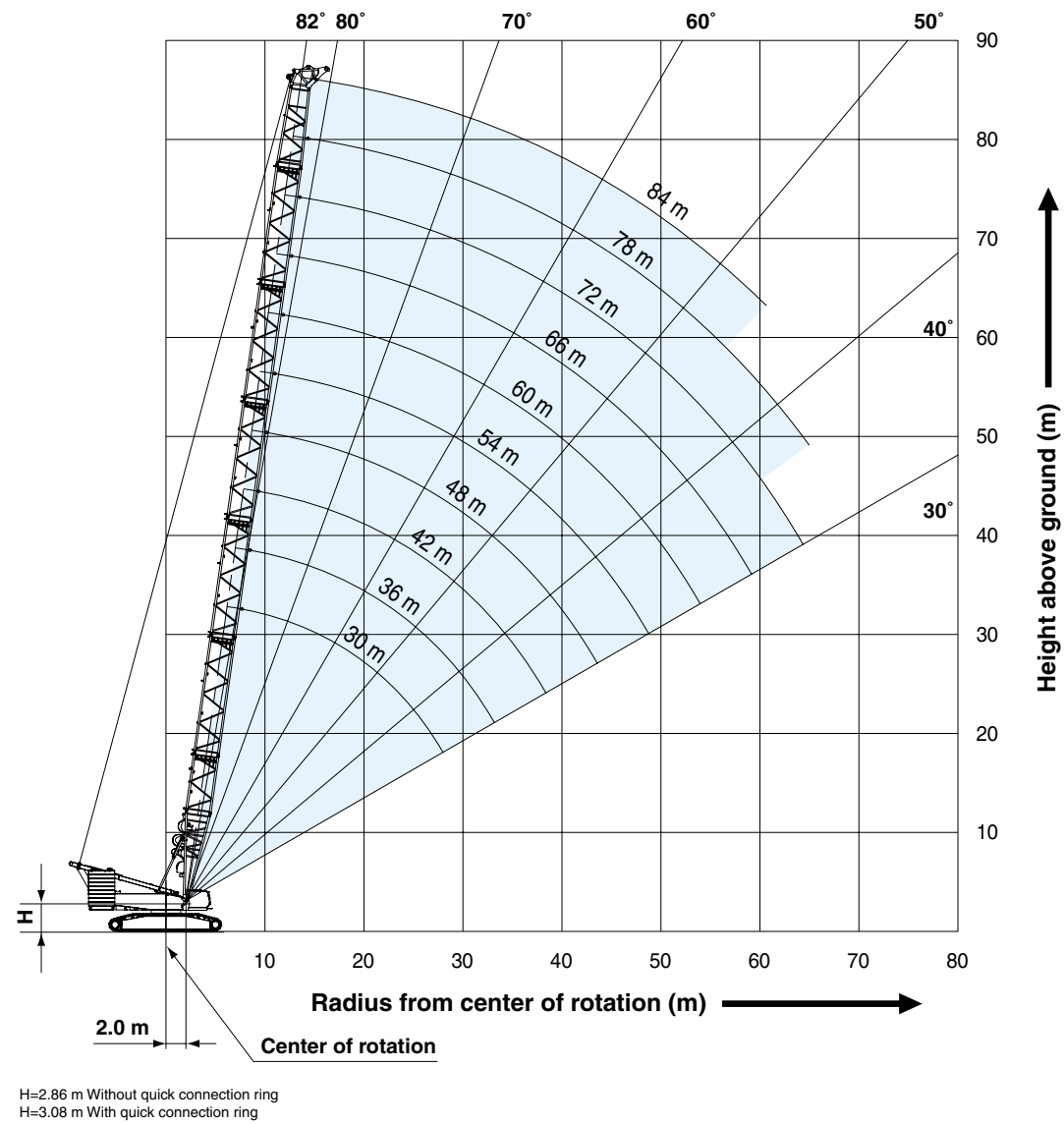

### Long Boom

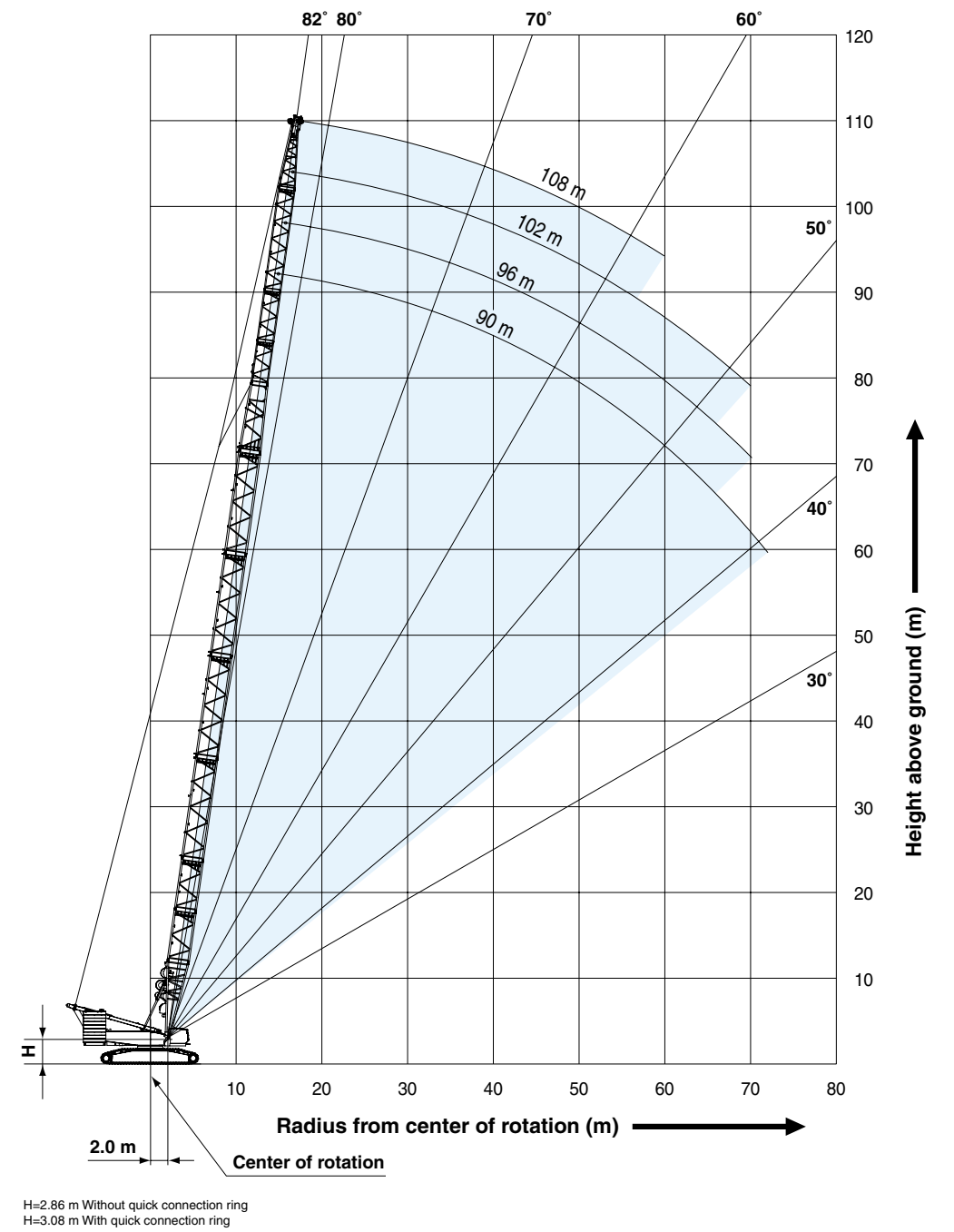

## WORKING RANGES

### Heavy Fixed Jib (Type A)

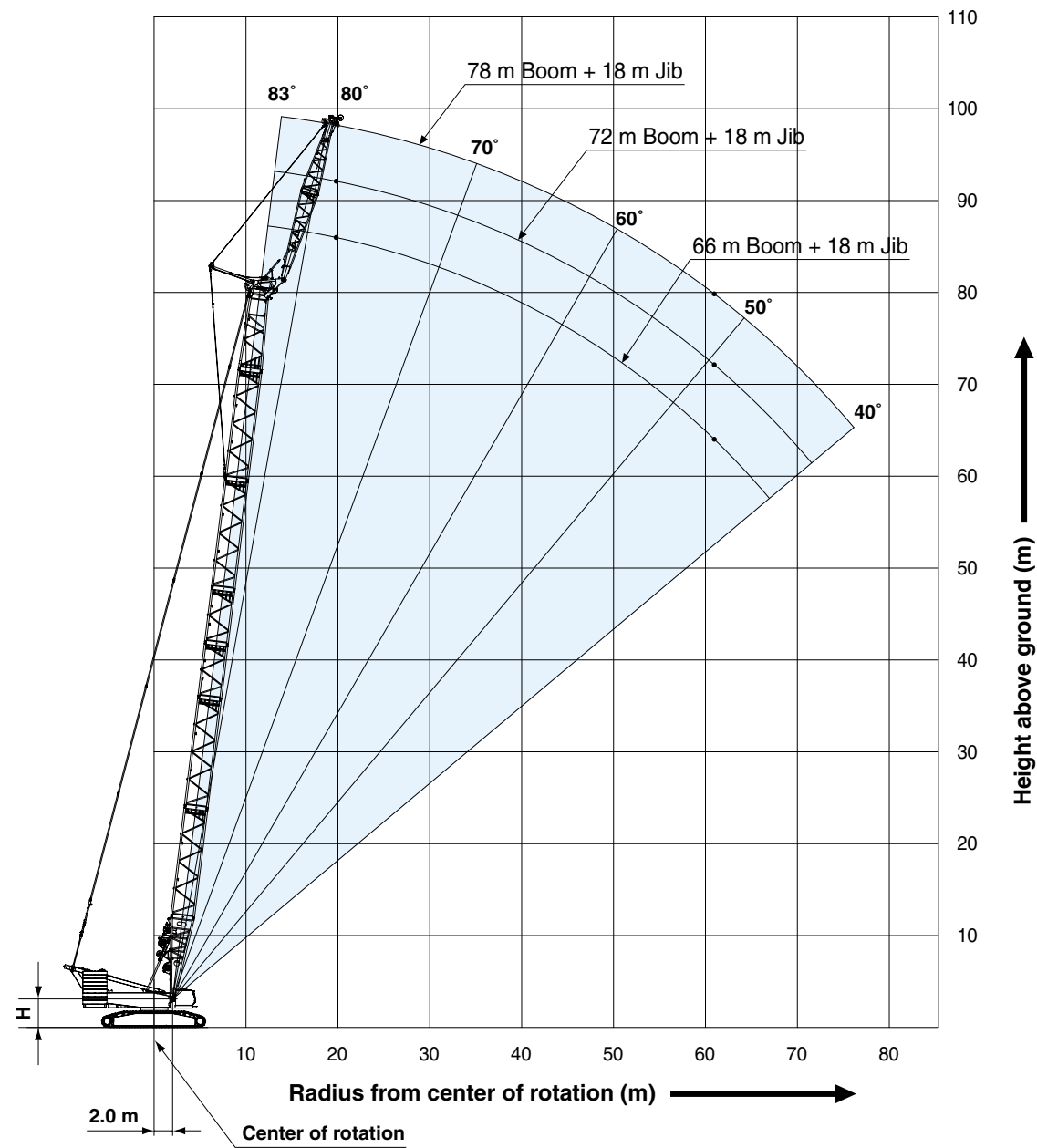

H=2.86 m Without quick connection ring  
H=3.08 m With quick connection ring

### Luffing Jib Boom Angle: 86°

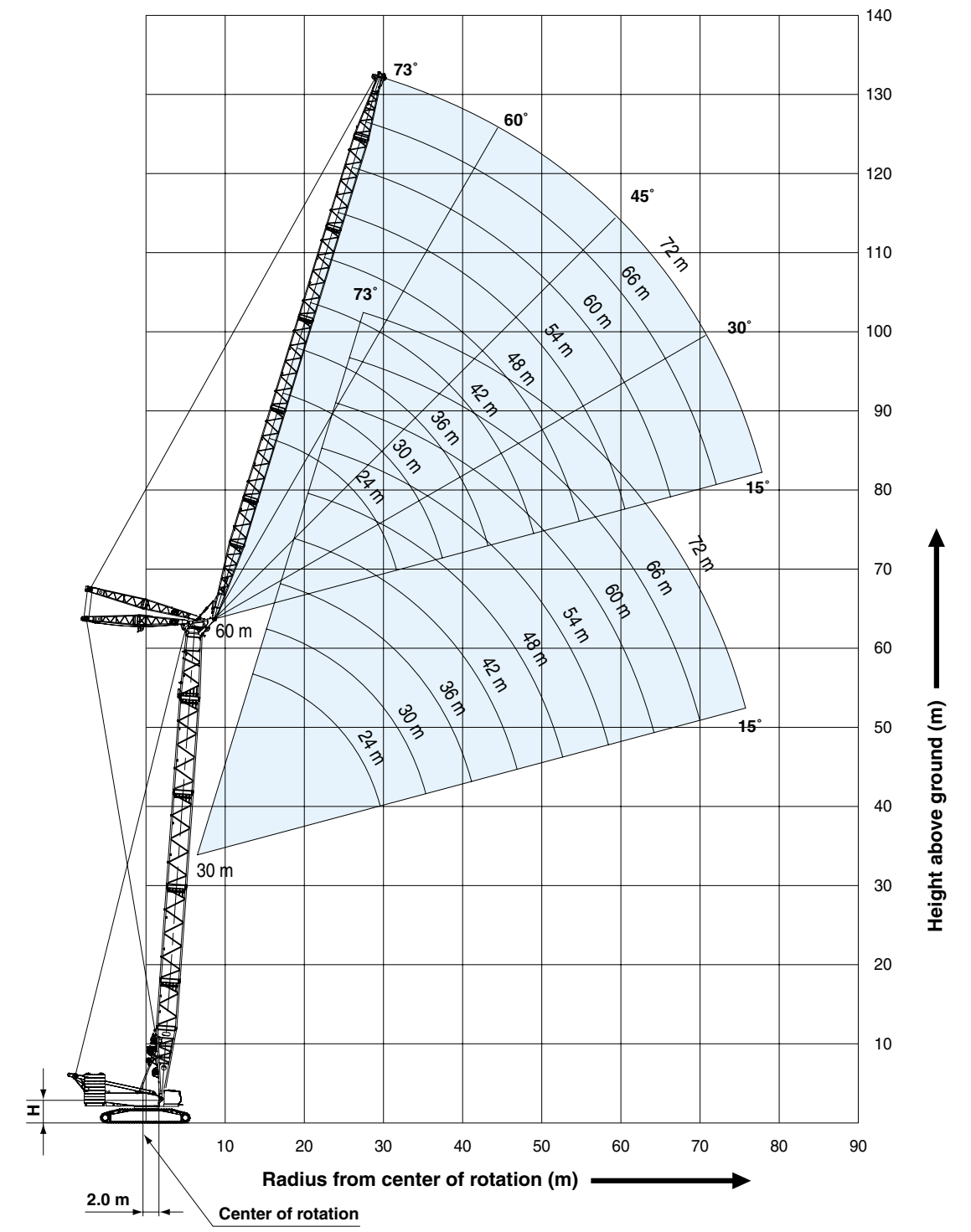

H=2.86 m Without quick connection ring  
H=3.08 m With quick connection ring

## WORKING RANGES

### Luffing Jib

Boom Angle: 76°

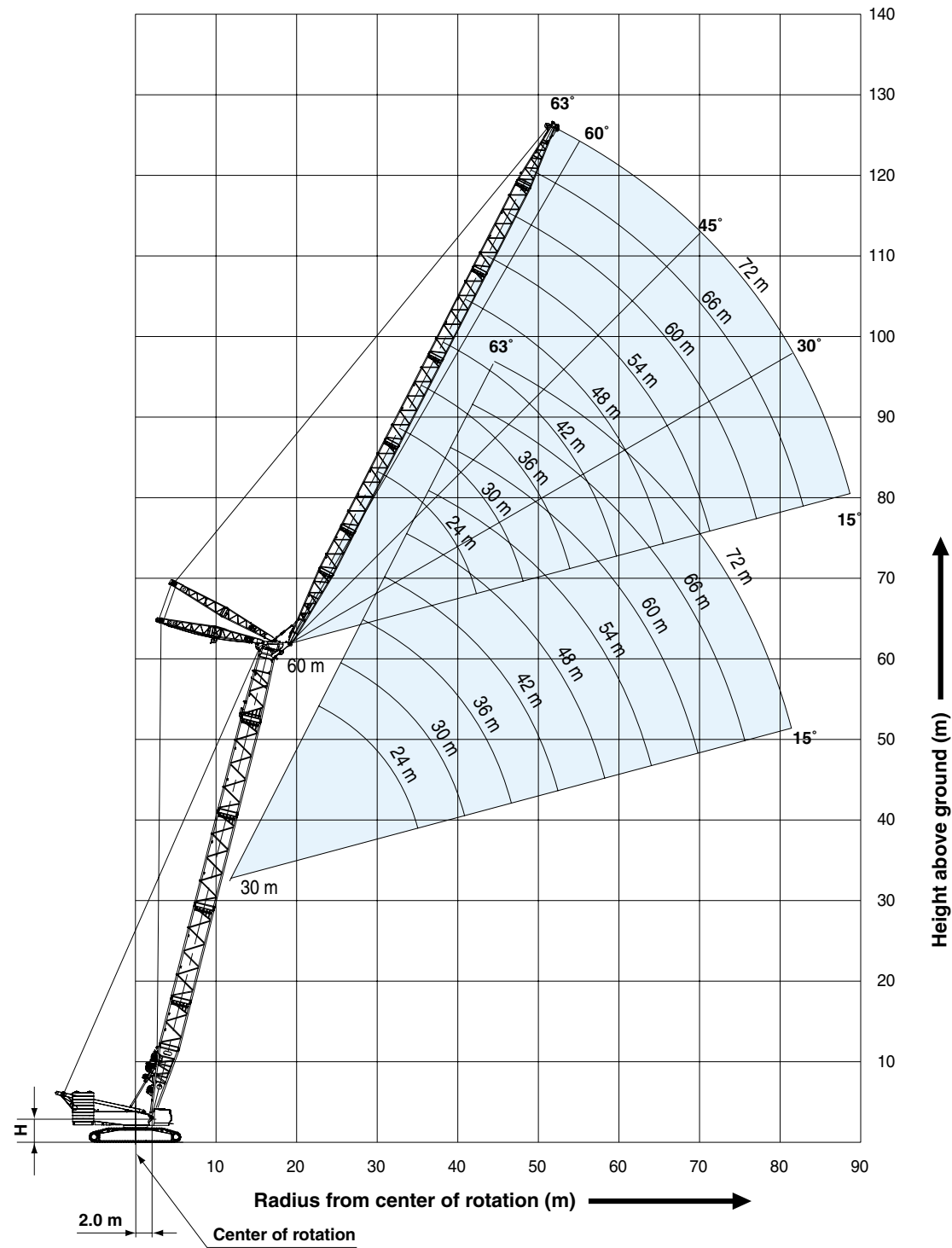

H=2.86 m Without quick connection ring  
H=3.08 m With quick connection ring

### Luffing Jib

Boom Angle: 66°

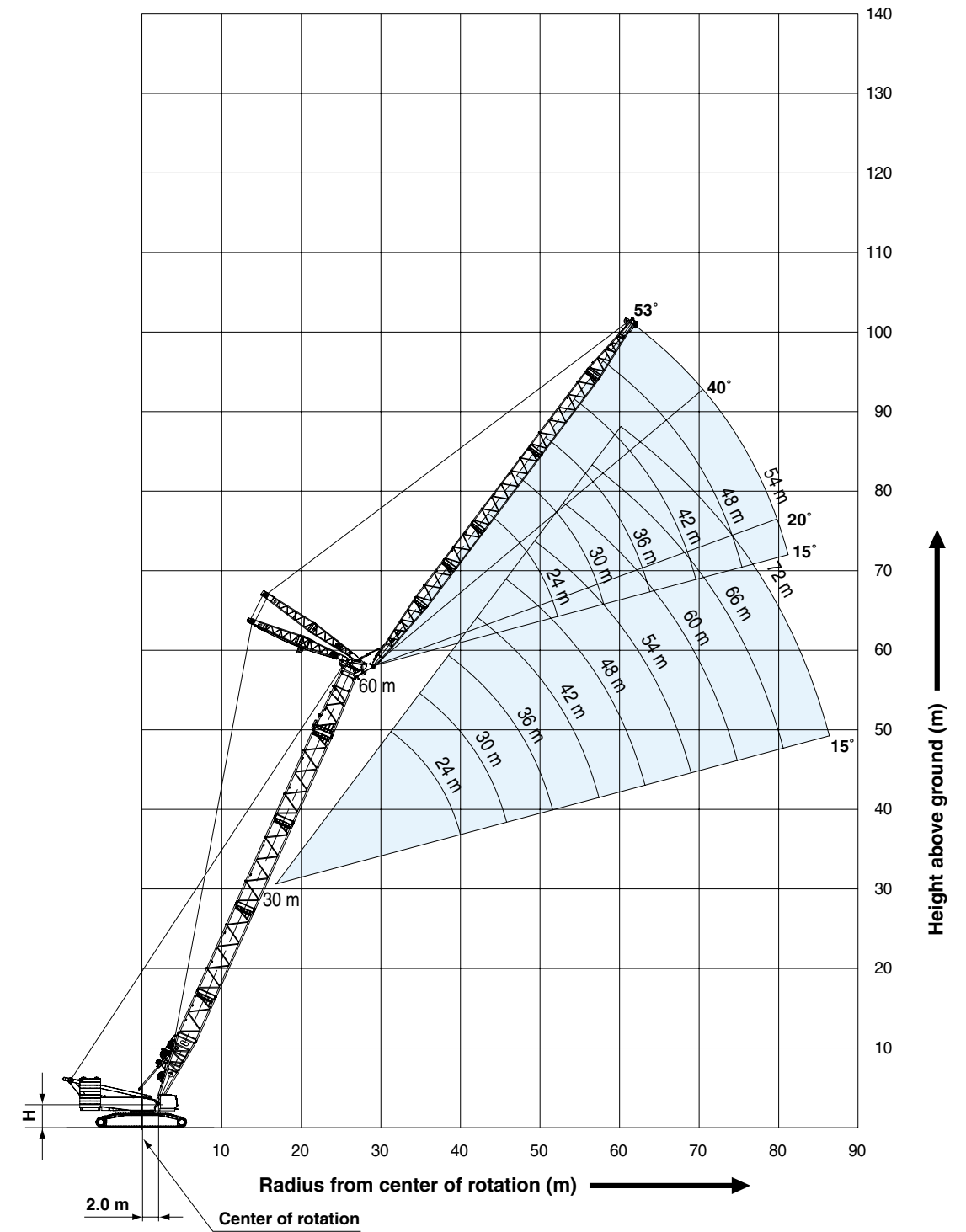

H=2.86 m Without quick connection ring  
H=3.08 m With quick connection ring

# CRANE BOOM SUPPLEMENTAL DATA

- Designed and rated to comply with EN13000.
- Operating radius is the horizontal distance from centerline of rotation to a vertical line through the center of gravity of the load.
- Deduct weight of hook block(s), slings and all other load handling accessories from main boom ratings shown.
- Ratings shown are based on freely suspended loads and make no allowance for such factors as wind effect on lifted load, ground conditions, out-of-level, operating speeds or any other condition that could be detrimental to the safe operation of this equipment. The operator, therefore, has the responsibility to judge the existing conditions and reduce lifted loads and operating speeds accordingly.
- Ratings are for operation on a firm and level surface, up to 1% gradient.
- At radii and boom lengths where no ratings are shown on chart, operation is not intended nor approved.
- Boom inserts, guy link and guy lines must be arranged as shown in the "OPERATOR'S MANUAL".
- Boom hoist reeving is 30 part line. HL/SHL boom hoist reeving is 18 part line.
- Boom backstops are required for all boom lengths.
- The boom should be erected over the front of the crawlers, not laterally.
- Ratings inside of boxes  are limited by strength of materials.
- When erecting and lowering the boom length of 102 m or over, the blocks for erection must be placed at the end of the crawlers. (for STD MAST)
- When erecting and lowering the boom length of 108 m, the blocks for erection must be placed at the end of the crawlers. (for HL MAST)
- The minimum rated show below.

Minimum Rated Load		
Heavy Crane	STD Crane	Long Crane
12.1 ton	7.7 ton	6.2 ton

## 15. (Main Boom Lifting)

The total load that can be lifted is the value for weight of hook block, slings, and all other load handling accessories deducted from main boom ratings shown.

## 16. (Main Boom Lifting with Auxiliary Sheave Frame)

The total load that can be lifted is weight of auxiliary sheave frame, hook block(s), slings, and all other load handling accessories deducted from main boom ratings shown.

Deduction auxiliary sheave frame		
Heavy Crane	STD Crane	Long Crane
0.7 ton	0.7 ton	0.7 ton

## 17. (Auxiliary Sheave Lifting)

The total load that can be lifted is weight of auxiliary sheave frame, hook block(s), slings, and all other load handling accessories deducted from main boom ratings shown.

Deduction auxiliary sheave frame		
Heavy Crane	STD Crane	Long Crane
0.7 ton	0.7 ton	0.7 ton

- Ratings shown, but it should not exceed 14.0 ton in case of one reeve. and it should not exceed 28.0 ton in case of two reeves.
- Auxiliary sheave ratings at any radius from center of rotation are the same as crane ratings shown in table for main boom when operated at the same radius. But maximum angle is the same main boom maximum angle.
- Boom lengths for auxiliary sheave mounting show below.

	Mast for STD	Mast for HL	Mast for SHL
Heavy Crane	NONE	NONE	NONE

	Mast for STD	Mast for HL	Mast for SHL
STD Crane	30 m ~ 84 m	36 m ~ 84 m	36 m ~ 84 m

	Mast for STD	Mast for HL	Mast for SHL
Long Crane	90 m ~ 102 m	90 m ~ 108 m	90 m ~ 120 m

- Maximum hoist load for number of reeving parts of line for hoist rope.

## Main Hoist Loads (Single Drum)

No. of Parts of Line	1	2	3	4	5
Maximum Loads (kN)	137	275	412	549	686
Maximum Loads (t)	14.0	28.0	42.0	56.0	70.0

No. of Parts of Line	6	7	8	9	10
Maximum Loads (kN)	824	961	1,098	1,236	1,373
Maximum Loads (t)	84.0	98.0	112.0	126.0	140.0

No. of Parts of Line	11	12	13	14	15
Maximum Loads (kN)	1,491	1,608	1,706	1,804	1,883
Maximum Loads (t)	152.0	164.0	174.0	184.0	192.0

No. of Parts of Line	16
Maximum Loads (kN)	1,961
Maximum Loads (t)	200.0

## Main Hoist Loads for Heavy Boom (Double Drum)

No. of Parts of Line	8	12	16	20	24
Maximum Loads (kN)	1,098	1,608	2,157	2,746	3,295
Maximum Loads (t)	112.0	164.0	220.0	280.0	336.0

No. of Parts of Line	28	36	44
Maximum Loads (kN)	3,628	4,413	5,394
Maximum Loads (t)	370.0	450.0	550.0

## Main Hoist Loads for STD Boom (Double Drum)

No. of Parts of Line	8	12	16	20	24
Maximum Loads (kN)	1,098	1,608	2,157	2,746	2,942
Maximum Loads (t)	112.0	164.0	220.0	280.0	300.0

## Auxiliary Hoist Loads

No. of Parts of Line	1	2
Maximum Loads (kN)	137	275
Maximum Loads (t)	14.0	28.0

- Weight of hook block

Weight of hook block				
Hook block	550/450 ton	300 ton (with hanger sheave)	200 ton (w/o hanger sheave)	120 ton
Weight (t)	11.7	9.9 (*1)	7.1 (*2)	4.5

Weight of hook block			
Hook block	70 ton	40 ton	14 ton Ball hook
Weight (t)	3.1	2.0	0.9

\*1: 7.82 ton: when hanger sheave is not equipped.

\*2: To reeve 11 parts line or over hanger sheave (2 t) is not required.

- The rated load of the work when the strut guy line is installed on the boom upper surface is value in the rated load chart minus the value in the table below.

Heavy crane, STD crane					
Boom length(m)	24	30	36	42	48
Subtract load(t)	0.4	0.6	0.7	0.9	1.1

Heavy crane, STD crane					
Boom length(m)	54	60	66	72	78
Subtract load(t)	1.2	1.4	1.6	1.7	1.9

Heavy crane, STD crane	
Boom length(m)	84
Subtract load(t)	2.1

Long crane					
Boom length(m)	90	96	102	108	114
Subtract load(t)	1.7	1.7	1.9	1.9	2.1

Long crane		
Boom length(m)	120	126
Subtract load(t)	2.1	2.1

Operation of this equipment in excess of rated loads or disregard of instruction voids the warranty.

# HEAVY FIXED JIB SUPPLEMENTAL DATA

1. Designed and rated to comply with EN13000.
2. Rated loads included in the charts are the maximum allowable freely suspended loads at a given boom length, boom angle and load radius, and have been determined for the machine standing level on firm supporting surface under ideal operating conditions. The user must limit or de-rate rated loads to allow for adverse conditions (such as soft or uneven ground, out-of-level conditions, wind, side loads, pendulum action, jerking or sudden stopping of loads, inexperience of personnel, multiple machine lifts, and traveling with a load).
3. Rated loads do not exceed 75% of minimum tipping loads. Ratings inside of boxes  are limited by strength of material or other factor except machine stability.
4. The machine must be reeved and set-up as stated in the operation manual and all the instruction manuals. If these manuals are missing, obtain replacements.
  - Boom backstops are required for all boom lengths.
  - The crane must be leveled to within 1% on a firm supporting surface.
5. Do not attempt to lift where no radius on load is listed as crane may tip or collapse.
6. Attempting to lift more than rated loads may cause machine to tip or collapse. Do not tip machine to determine rated loads.
7. Weight of hooks, hook blocks, slings and other lifting devices are a part of the total load. Their total weight must be subtracted from the rated load to obtain the weight that can be lifted.

## 8. Configuration

Symbol	Counterweight	Carbody Weight	HL Mast Radius	Pallet Weight
A	200 t	50 t	NONE	NONE
B1	200 t	50 t	11 m	NONE
B2	200 t	50 t	11 m	10 t
C	200 t	50 t	11 m	130 t

## 9. Boom and Heavy Fixed Jib combinations

Boom	Jib	Type of configuration			
		A	B1	B2	C
66 m	18 m	Y	Y	Y	N
72 m	18 m	Y	Y	Y	
78 m	18 m	Y	Y	Y	
84 m	18 m	N			Y
90 m	18 m				Y
96 m	18 m				Y
102 m	18 m				Y

Y: Applicable boom and heavy fixed jib combination  
N: Not applicable boom and heavy fixed jib combination

## 10. The boom should erected lowered over the front of the crawlers

Boom	Jib	Type of configuration			
		A	B1	B2	C
66 m	18 m	N	N	N	N
72 m	18 m	N	N	N	
78 m	18 m	Y	N	N	
84 m	18 m	N			N
90 m	18 m				N
96 m	18 m				N
102 m	18 m				N

Y: the blocks must be placed at the end of the crawlers for erection and lowering.

N: the blocks is not needed for erection and lowering.

11. To prevent the boom from leaning toward backward, the own weight of hook block attached to heavy fixed jib point must be equal to or more than 4.5 t.

12. Maximum hoist load for number of reeving parts of line for hoist rope.

### Main Boom Hoist Loads (Double Drum)

No. of Parts of Line	8(2x4)	10(2x5)
Maximum Loads (kN)	1,098	1,177
Maximum Loads (t)	112.0	120.0

### Main Boom Hoist Loads (Single Drum)

No. of Parts of Line	1	2	3	4	5
Maximum Loads (kN)	137	275	412	549	686
Maximum Loads (t)	14.0	28.0	42.0	50.0	70.0

No. of Parts of Line	6	7	8
Maximum Loads (kN)	824	961	1,098
Maximum Loads (t)	84.0	98.0	112.0

- 13.

Rated loads listed apply only to the machine as originally manufactured and designed by KOBELCO CRANES CO.,LTD. Modifications to this machine or use of equipment other than that specified can reduce operating capacity.

Operation of this equipment in excess of rated loads or disregard of instruction voids the warranty.





# LUFFING JIB SUPPLEMENTAL DATA

### 21. Hook block and number of reeving parts of line restriction

- (1) The self-weight of luffing jib point hook block must be heavier than or equal to the table below.
- (2) Total number of reeving parts of line on luffing jib point hook block must be larger than or equal to the table below.

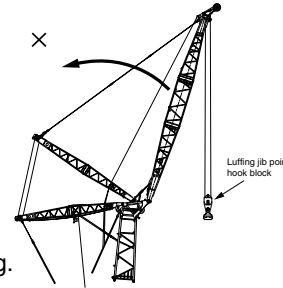

**Danger!**

Follow the both (1) and (2) above at a same time for the luffing jib operation.

Otherwise luffing jib may tip over the backwards due to lack of weight on front side of boom.

Failure to observe this precaution may lead to the jib tipping backwards and resulted to machine collapsing.

#### SL6000G minimum hook block self-weight and minimum number of reeving parts of line on hook block

Boom Length	Jib Length											
	24 m (79 ft)	30 m (98 ft)	36 m (118 ft)	42 m (138 ft)	48 m (157 ft)	54 m (177 ft)	60 m (197 ft)	66 m (217 ft)	72 m (236 ft)	78 m (256 ft)	84 m (276 ft)	
30 m (98 ft)	Hook Block Self-Weight (kg)	7,050	4,500	3,100	2,000	2,000	2,000	2,000	2,000	2,000	2,000	2,000
	No. of Part Line	13	6	4	2	2	2	2	2	2	2	2
36 m (118 ft)	Hook Block Self-Weight (kg)	7,050	4,500	3,100	2,000	2,000	2,000	2,000	2,000	2,000	2,000	2,000
	No. of Part Line	11	6	4	2	2	2	2	2	2	2	2
42 m (138 ft)	Hook Block Self-Weight (kg)	7,050	7,050	3,100	2,000	2,000	2,000	2,000	2,000	2,000	2,000	2,000
	No. of Part Line	10	9	4	2	2	2	2	2	2	2	2
48 m (157 ft)	Hook Block Self-Weight (kg)	7,050	7,050	3,100	2,000	2,000	2,000	2,000	2,000	2,000	2,000	2,000
	No. of Part Line	9	9	4	2	2	2	2	2	2	2	2
54 m (177 ft)	Hook Block Self-Weight (kg)	7,050	7,050	4,500	3,100	2,000	2,000	2,000	2,000	2,000	2,000	2,000
	No. of Part Line	9	8	6	2	2	2	2	2	2	2	2
60 m (197 ft)	Hook Block Self-Weight (kg)	7,050	7,050	7,050	3,100	2,000	2,000	2,000	2,000	2,000	2,000	2,000
	No. of Part Line	8	7	7	3	2	2	2	2	2	2	2
66 m (217 ft)	Hook Block Self-Weight (kg)	7,050	7,050	7,050	4,500	3,100	2,000	2,000	2,000	2,000	2,000	2,000
	No. of Part Line	7	7	6	2	2	2	2	2	2	2	2
72 m (236 ft)	Hook Block Self-Weight (kg)	7,050	7,050	7,050	4,500	3,100	2,000	2,000	2,000	2,000	2,000	2,000
	No. of Part Line	7	6	6	2	2	2	2	2	2	2	2
78 m (256 ft)	Hook Block Self-Weight (kg)		7,050	7,050	4,500	3,100	2,000	2,000	2,000	2,000	2,000	2,000
	No. of Part Line		6	5	2	2	2	2	2	2	2	2
84 m (276 ft)	Hook Block Self-Weight (kg)		7,050	7,050	4,500	3,100	2,000	2,000	2,000	2,000	2,000	2,000
	No. of Part Line		5	5	3	2	2	2	2	2	2	2

Weight of KOBELCO genuine hook block.

- 200 t hook block 7,050 kg
- 120 t hook block 4,500 kg
- 70 t hook block 3,100 kg
- 40 t hook block 2,000 kg

---

---

---

---

---

---

---

---

---

---

---

---

---

---

---

---

---

---

---

---

---

---

---

---

---

---

---

---

---

---







## BOOM AND JIB ARRANGEMENTS

### Heavy Duty Crane Boom Arrangements

Boom length m (ft)	Boom arrangement
36 (118)	※
42 (138)	※ 
48 (157)	※
54 (177)	※ 
60 (197)	※
66 (217)	※ 
72 (236)	※
78 (256)	※ 
84 (276)	※

Symbol	Boom Length	Remarks
	9.0 m (29.5 ft)	Boom Base
	8.0 m (26.2 ft)	Tapered Boom
	6.0 m (19.7 ft)	Insert Boom
	12.0 m (39.4 ft)	Insert Boom
	1.0 m (3.3 ft)	Boom Top

※ indicates the most flexible combination of insert heavy duty booms, which can be modified to form all shorter heavy duty boom arrangements.

### Long Boom Arrangements

Boom length m (ft)	Boom arrangement
90 (295)	
96 (315)	※ 
102 (335)	※   
108 (354)	※ 

Symbol	Boom Length	Remarks
	9.0 m (29.5 ft)	Boom Base
	8.0 m (26.2 ft)	Tapered Boom
	6.0 m (19.7 ft)	Insert Boom
	12.0 m (39.4 ft)	Insert Boom
	5.0 m (16.4 ft)	Luffing Insert Jib
	6.0 m (19.7 ft)	Luffing Insert Jib
	12.0 m (39.4 ft)	Luffing Insert Jib
	8.0 m (26.2 ft)	Jib Top

※ indicates the most flexible combination of insert long booms, which can be modified to form all shorter long boom arrangements.

### Luffing Boom Arrangements for Crane

Boom length m (ft)	Boom arrangement
36 (118)	※
42 (138)	※ 
48 (157)	※
54 (177)	※ 
60 (197)	※
66 (217)	※ 
72 (236)	※
78 (256)	※ 
84 (276)	※

Symbol	Boom Length	Remarks
	9.0 m (29.5 ft)	Boom Base
	8.0 m (26.2 ft)	Tapered Boom
	6.0 m (19.7 ft)	Insert Boom
	12.0 m (39.4 ft)	Insert Boom
	1.0 m (3.3 ft)	Boom Top

※ indicates the most flexible combination of insert luffing booms, which can be modified to form all shorter luffing boom arrangements.

### Heavy Fixed Jib Boom Arrangements (Type B1)

Boom length m (ft)	Boom arrangement
66 (217)	※ 
72 (236)	※
78 (256)	※ 

Symbol	Boom Length	Remarks
	9.0 m (29.5 ft)	Boom Base
	8.0 m (26.2 ft)	Tapered Boom
	6.0 m (19.7 ft)	Insert Boom
	12.0 m (39.4 ft)	Insert Boom
	1.0 m (3.3 ft)	Boom Top

↗ mark shows the guy line installing position when the fixed jib is used.  
※ indicates the most flexible combination of insert luffing booms, which can be modified to form all shorter luffing boom arrangements.

### Heavy Fixed Jib Arrangements (Type B1)

Jib length m (ft)	Jib arrangement
18 (59)	

Symbol	Jib Length	Remarks
	10.0 m (32.8 ft)	Jib Base
	8.0 m (26.2 ft)	Jib Top

## BOOM AND JIB ARRANGEMENTS

### Luffing Boom Arrangements for Luffing

Boom length m (ft)	Boom arrangement
36 (118)	※ [L] 6.0   12.0   [8T] [LU]
42 (138)	※ [L] 6.0   12.0   6.0   [8T] [LU] [L] 12.0   12.0   [8T] [LU]
48 (157)	※ [L] 12.0   12.0   6.0   [8T] [LU]
54 (177)	※ [L] 6.0   6.0   12.0   12.0   [8T] [LU] [L] 12.0   12.0   12.0   [8T] [LU]
60 (197)	※ [L] 12.0   12.0   6.0   12.0   [8T] [LU]
66 (217)	※ [L] 6.0   6.0   12.0   12.0   12.0   [8T] [LU] [L] 12.0   12.0   12.0   12.0   [8T] [LU]

Symbol	Boom Length	Remarks
[L]	9.0 m (29.5 ft)	Boom Base
[8T]	8.0 m (26.2 ft)	Tapered Boom
[6.0]	6.0 m (19.7 ft)	Insert Boom
[12.0]	12.0 m (39.4 ft)	Insert Boom
[LU]	1.0 m (3.3 ft)	Boom Top

※ indicates the most flexible combination of insert luffing booms, which can be modified to form all shorter luffing boom arrangements.

### Luffing Jib Arrangements

Jib length m (ft)	Jib arrangement
24 (79)	[L] 6.0 [U]
30 (98)	※ [L] 6.0   6.0 [U] [L] 12.0 [U]
36 (118)	※ [L] 6.0   12.0 [U]
42 (138)	※ [L] 6.0   6.0   12.0 [U] [L] 12.0   12.0 [U]
48 (157)	※ [L] 6.0   12.0   12.0 [U]
54 (177)	※ [L] 6.0   6.0   12.0   12.0 [U] [L] 12.0   12.0   12.0 [U]
60 (197)	※ [L] 6.0   12.0   12.0   12.0 [U]
66 (217)	※ [L] 6.0   6.0   12.0   12.0   12.0 [U] [L] 12.0   12.0   12.0   12.0 [U]
72 (236)	※ [L] 6.0   12.0   12.0   12.0   12.0 [U]

Symbol	Jib Length	Remarks
[L]	10.0 m (32.8 ft)	Jib Base
[6.0]	6.0 m (19.7 ft)	Luffing Insert Jib
[12.0]	12.0 m (39.4 ft)	Luffing Insert Jib
[U]	8.0 m (26.2 ft)	Jib Top

※ indicates the most flexible combination of insert luffing jibs, which can be modified to form all shorter luffing jib arrangements.

### HL MAST

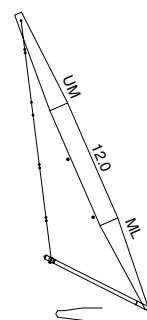

Symbol	Mast Length	Remarks
[ML]	9.0 m (29.5 ft)	Mast Base
[12.0]	12.0 m (39.4 ft)	Insert Mast
[UM]	9.0 m (29.5 ft)	Mast Top

## WORKING RANGES

### Heavy Duty Crane Boom

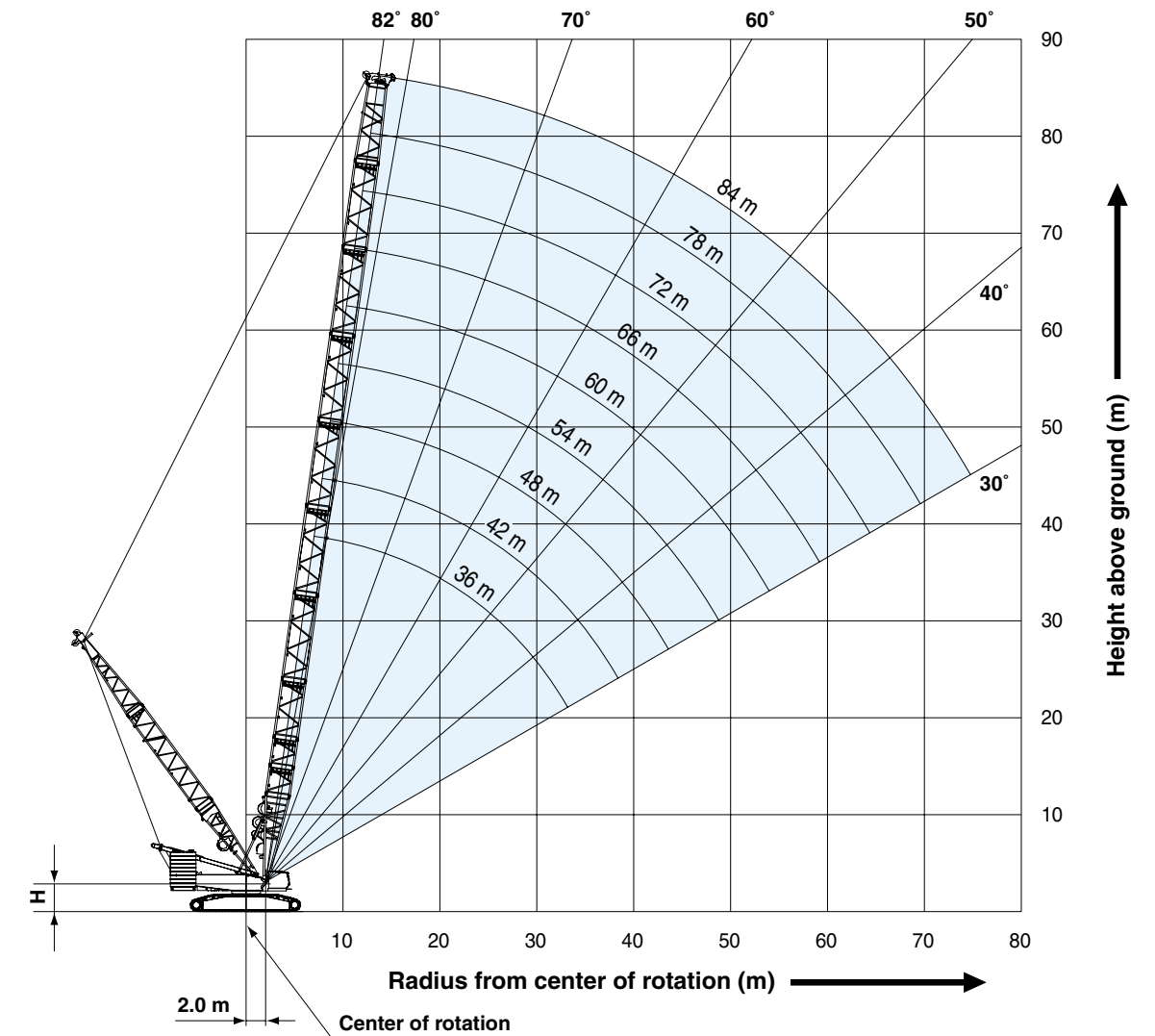

H=2.86 m Without quick connection ring  
H=3.08 m With quick connection ring

## WORKING RANGES

### Luffing Boom

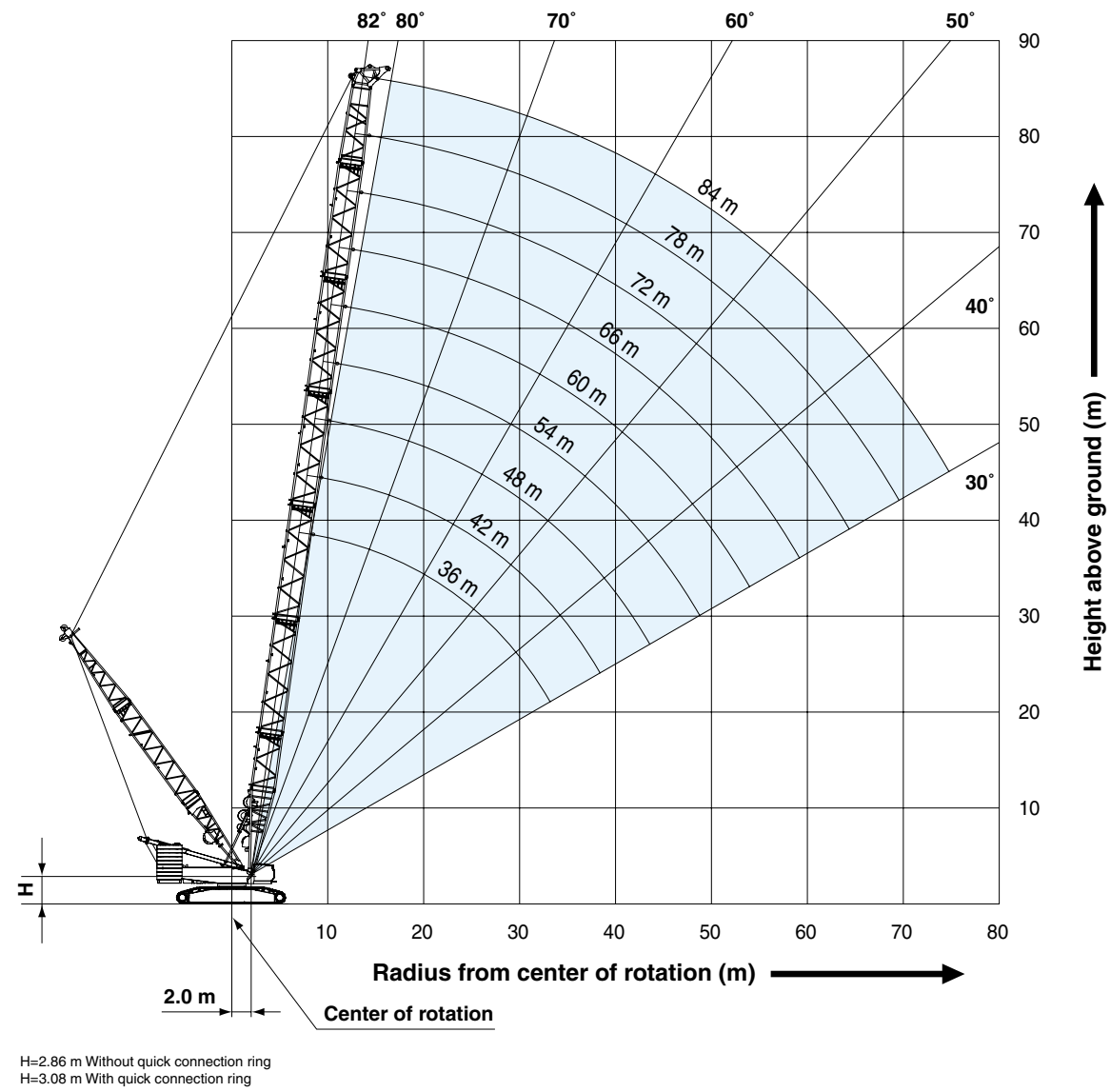

### Long Boom

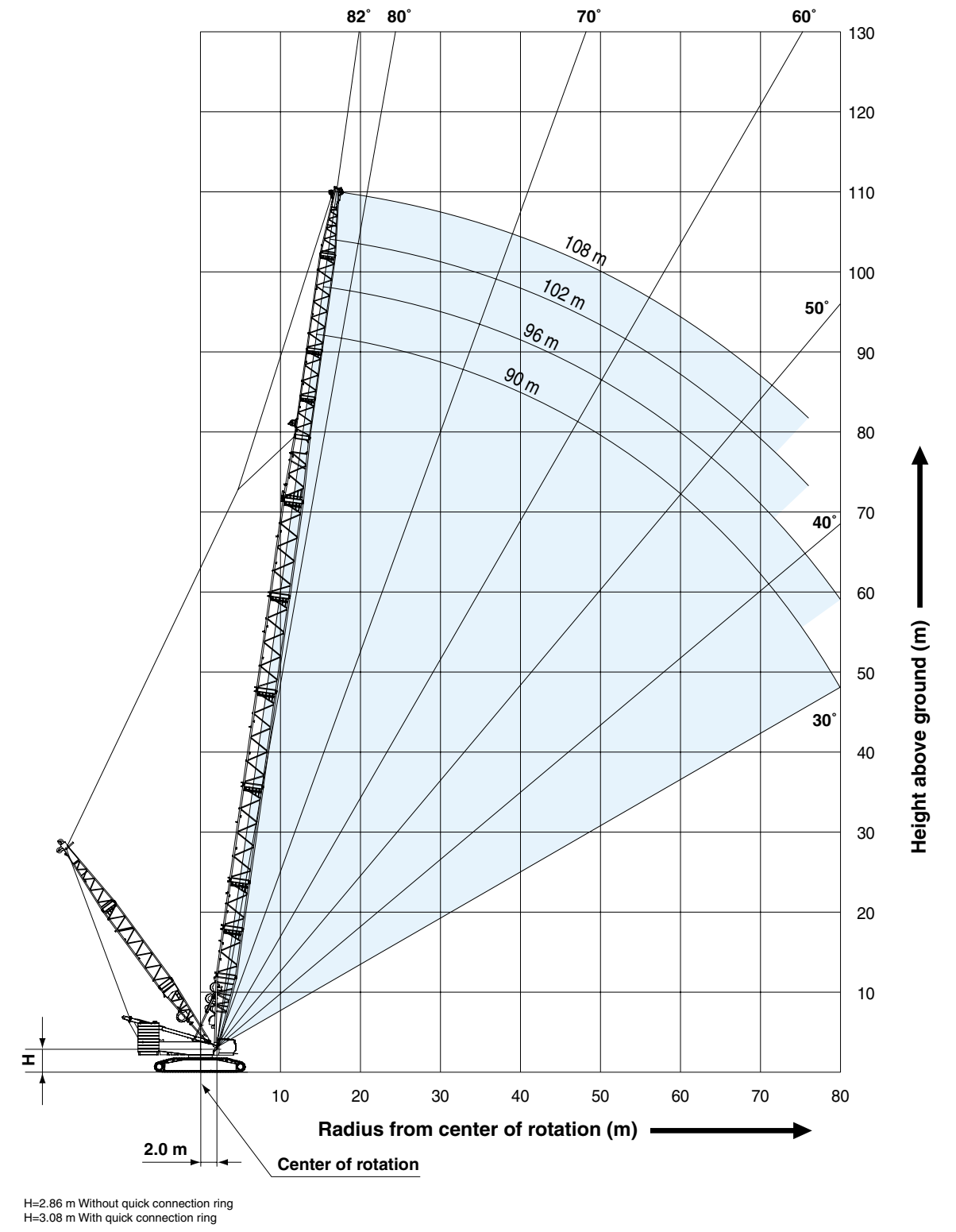

## WORKING RANGES

### Heavy Fixed Jib (Type B1)

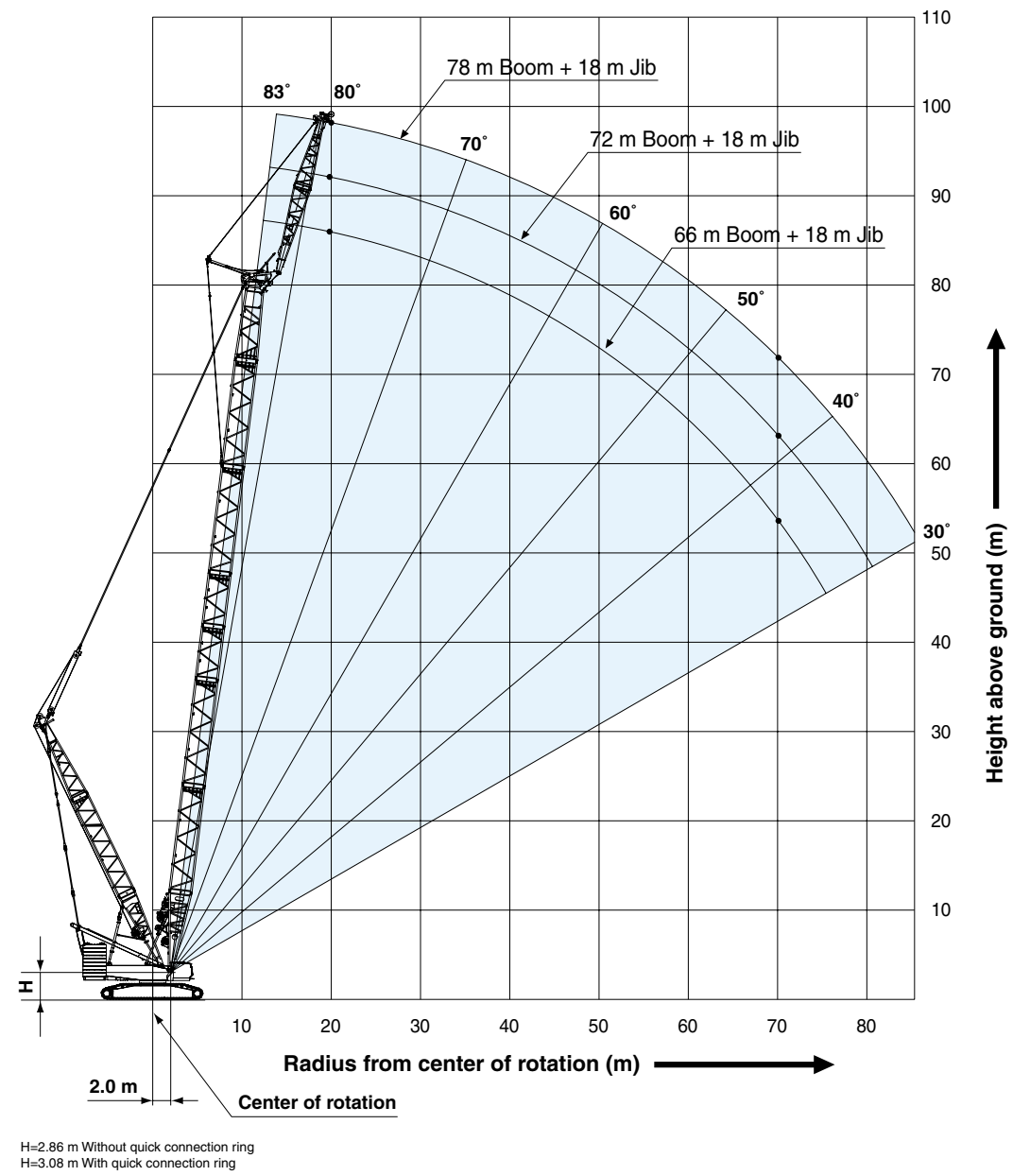

### Luffing Jib Boom Angle: 86°

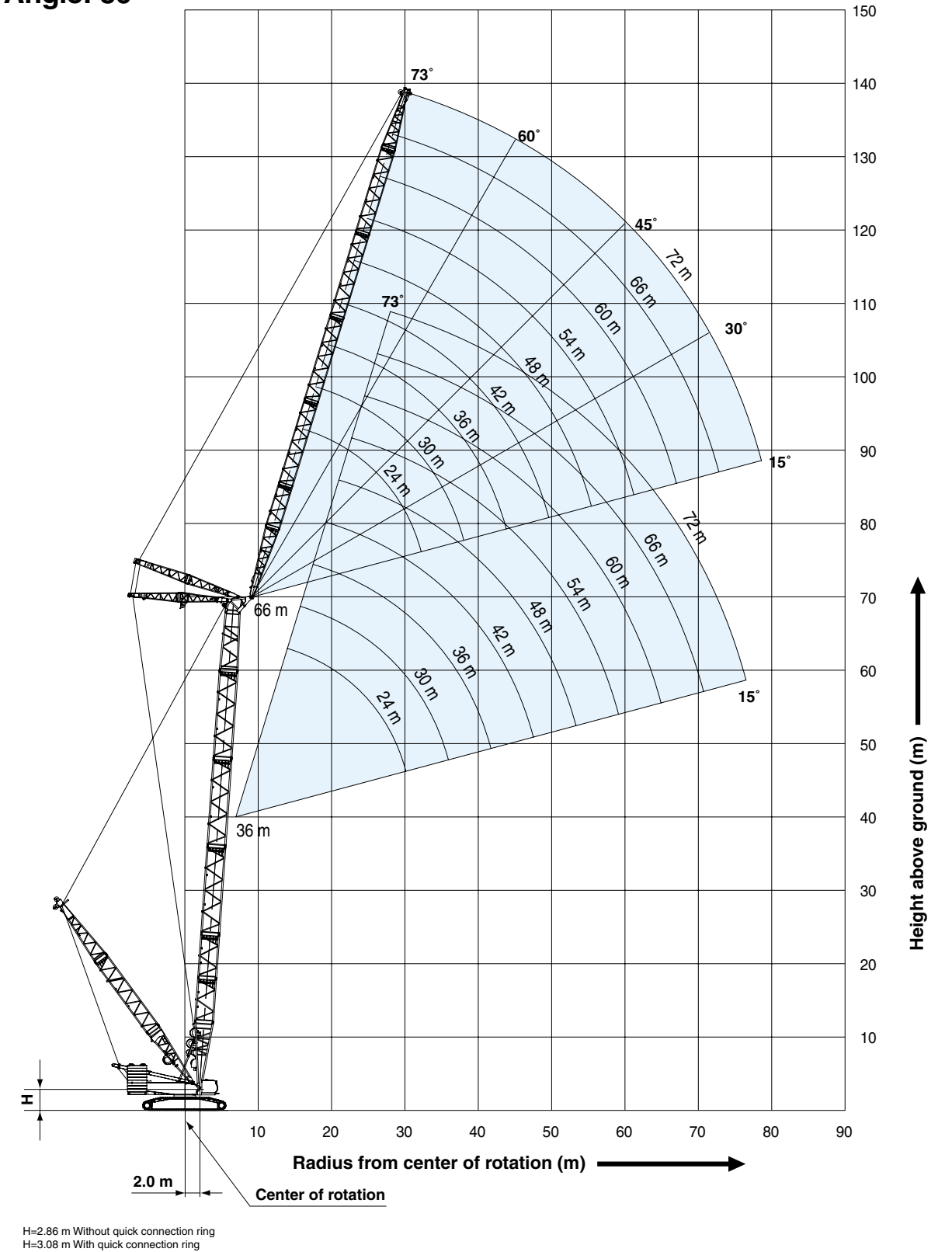



## WORKING RANGES

### Luffing Jib

Boom Angle: 76°

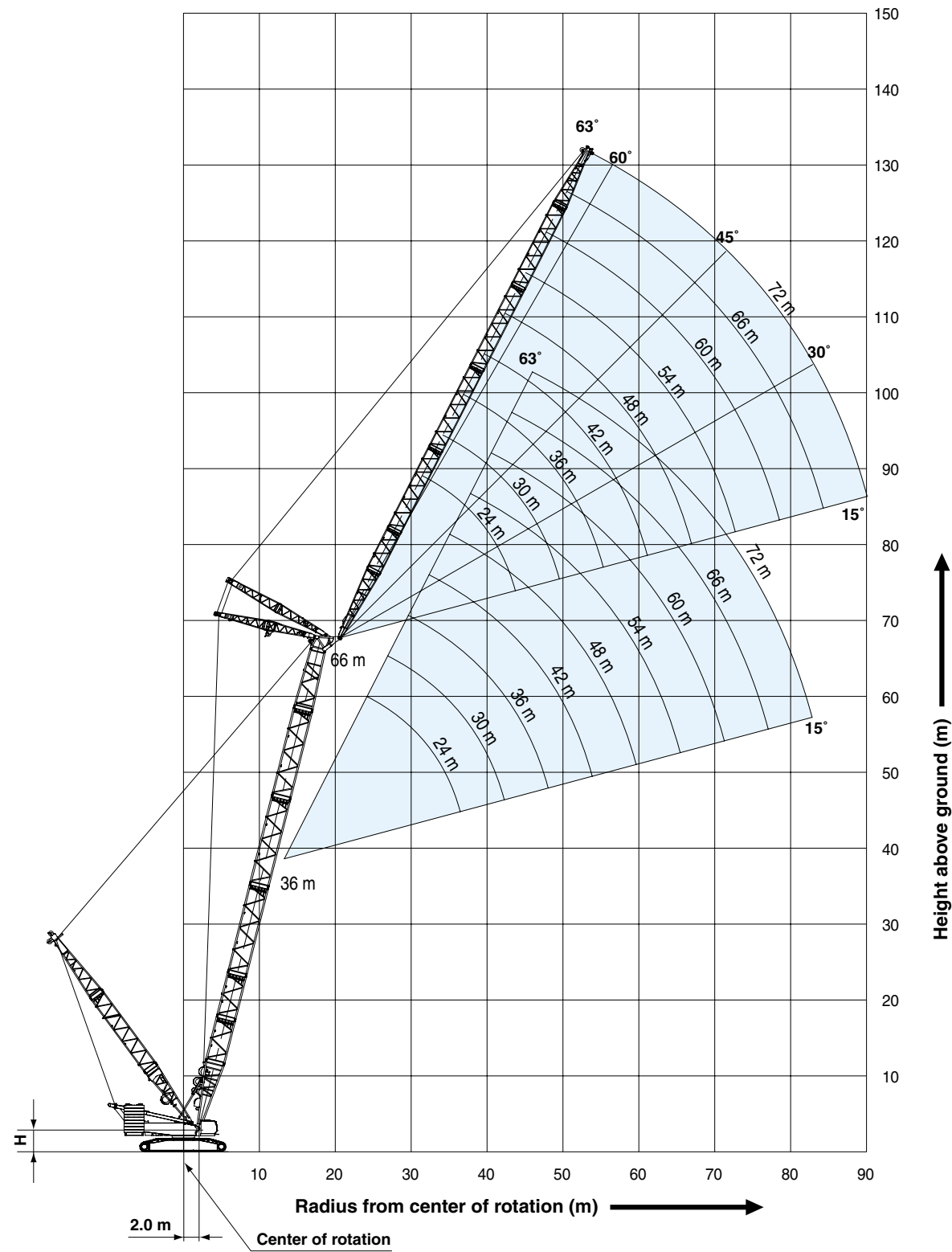

H=2.86 m Without quick connection ring  
H=3.08 m With quick connection ring

### Luffing Jib

Boom Angle: 66°

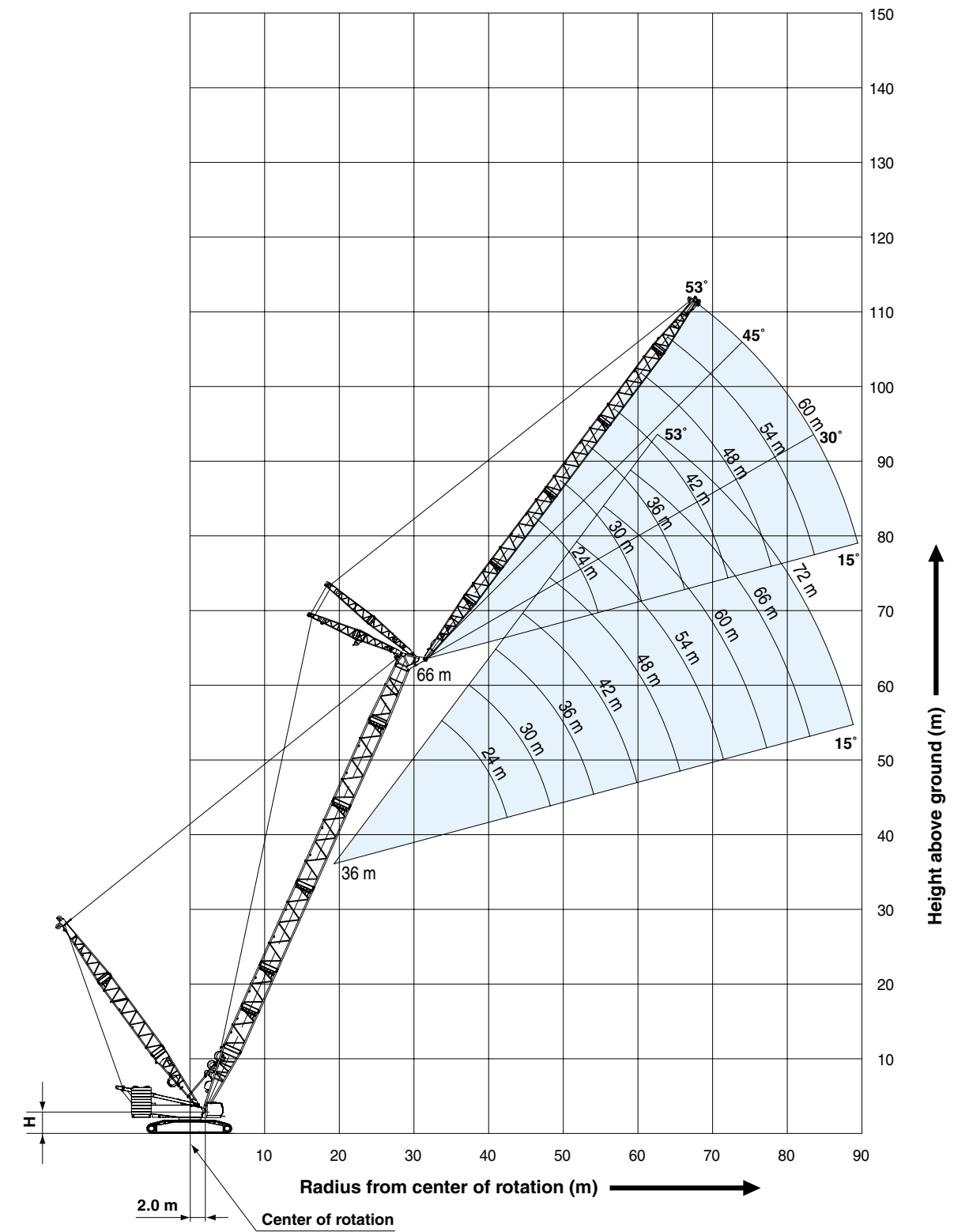

H=2.86 m Without quick connection ring  
H=3.08 m With quick connection ring

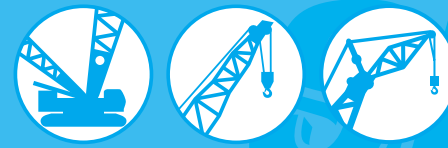
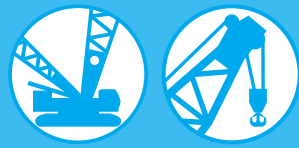

## LIFTING CAPACITIES Heavy Duty Crane Boom Lifting Capacities

Unit: ton

Counterweight: 200.0 ton, Carbody weight: 50.0 ton  
HL Mast point radius: 11 m to 16 m

Working Radius (m)	36.0		42.0		48.0		54.0		60.0		66.0		72.0		78.0		84.0		Working Radius (m)
	Boom Length (m)	Working Radius (m)	Boom Length (m)	Working Radius (m)	Boom Length (m)	Working Radius (m)	Boom Length (m)	Working Radius (m)	Boom Length (m)	Working Radius (m)	Boom Length (m)	Working Radius (m)	Boom Length (m)	Working Radius (m)	Boom Length (m)	Working Radius (m)	Boom Length (m)	Working Radius (m)	
8.0	8.3 m/370.0																		8.0
9.0	353.3	9.2 m/336.0																	9.0
10.0	308.5	309.1	10.0 m/309.5	10.9 m/276.1	11.7 m/251.2														10.0
12.0	243.3	243.6	243.7	243.5	243.0	12.5 m/220.0	13.4 m/201.2												12.0
14.0	199.8	199.9	199.8	199.5	198.9	198.1	192.1	14.2 m/182.3	15.0 m/164.0										14.0
16.0	168.8	168.7	168.5	168.1	167.4	166.5	165.7	160.8	155.2										16.0
18.0	145.5	145.3	145.0	144.5	143.7	142.9	142.0	141.0	136.8										18.0
20.0	127.4	127.1	126.8	126.2	125.4	124.5	123.6	122.6	121.5										20.0
22.0	112.9	112.6	112.2	111.6	110.7	109.8	108.9	107.8	106.7										22.0
24.0	101.1	100.7	100.2	99.6	98.7	97.7	96.8	95.8	94.6										24.0
26.0	91.2	90.7	90.3	89.6	88.7	87.7	86.8	85.7	84.6										26.0
28.0	82.8	82.3	81.9	81.2	80.2	79.2	78.3	77.2	76.0										28.0
30.0	75.6	75.1	74.6	73.9	73.0	72.0	71.0	69.9	68.7										30.0
32.0	69.4	68.9	68.4	67.7	66.7	65.7	64.7	63.6	62.4										32.0
34.0	33.8 m/64.4	63.4	62.9	62.2	61.2	60.2	59.2	58.1	56.9										34.0
36.0		58.6	58.1	57.4	56.4	55.3	54.3	53.2	52.0										36.0
38.0		54.3	53.8	53.0	52.1	51.0	50.0	48.9	47.7										38.0
40.0		39.0 m/52.3	49.9	49.2	48.2	47.1	46.1	45.0	43.8										40.0
44.0			43.3	42.6	41.6	40.5	39.5	38.4	37.2										44.0
48.0			44.2 m/43.0	37.1	36.1	35.0	34.0	32.9	31.7										48.0
52.0				49.4 m/35.4	31.5	30.4	29.4	28.3	27.1										52.0
56.0					54.6 m/28.9	26.5	25.5	24.4	23.1										56.0
60.0						59.8 m/23.3	22.1	21.0	19.8										60.0
64.0							19.2	18.0	16.8										64.0
68.0							65.0 m/18.5	15.4	68.0 m/14.2										68.0
72.0								70.2 m/14.1											72.0
Reeves	28	24	24	20	20	16	16	16	12										Reeves

Note: Designed and rated to comply with EN13000.

Ratings shown in [ ] are determined by the strength of the boom or other structural components.  
Lifting capacities may vary depending on hook used or with / without auxiliary sheave.  
Please refer rated chart in operator's cabin.  
Please refer Page 21 for Crane Boom Supplemental Data.

## Long Boom Lifting Capacities

Unit: ton

Counterweight: 200.0 ton, Carbody weight: 50.0 ton  
HL Mast point radius: 11 m to 16 m

Working Radius (m)	90.0		96.0		102.0		108.0		Working Radius (m)
	Boom Length (m)	Working Radius (m)	Boom Length (m)	Working Radius (m)	Boom Length (m)	Working Radius (m)	Boom Length (m)	Working Radius (m)	
14.0	15.0 m/98.0	15.8 m/98.0							14.0
16.0	98.0	98.0	16.6 m/84.0	17.5 m/84.0					16.0
18.0	98.0	98.0	84.0	84.0					18.0
20.0	98.0	98.0	84.0	84.0					20.0
22.0	95.7	95.7	84.0	84.0					22.0
24.0	87.7	87.7	84.0	84.0					24.0
26.0	81.0	81.0	81.0	81.0					26.0
28.0	75.2	75.2	75.2	75.0					28.0
30.0	70.2	70.2	70.2	68.9					30.0
32.0	65.4	65.3	64.1	63.4					32.0
34.0	59.9	59.7	58.5	58.3					34.0
36.0	55.0	54.8	53.6	53.4					36.0
38.0	50.7	50.5	49.3	49.1					38.0
40.0	46.8	46.6	45.4	45.2					40.0
44.0	40.2	40.0	38.7	38.5					44.0
48.0	34.7	34.5	33.2	33.0					48.0
52.0	30.1	29.8	28.6	28.4					52.0
56.0	26.1	25.9	24.7	24.4					56.0
60.0	22.7	22.5	21.3	21.1					60.0
64.0	19.8	19.5	18.2	18.0					64.0
68.0	17.1	16.7	15.4	15.2					68.0
72.0	14.6	14.2	12.9	12.7					72.0
76.0	12.4	12.0	76.0 m/10.7	76.0 m/10.5					76.0
80.0	10.5	80.0 m/10.1							80.0
84.0	80.1 m/10.5								84.0
Reeves	7	7	6	6					Reeves

Note:

Designed and rated to comply with EN13000.

Ratings shown in [ ] are determined by the strength of the boom or other structural components.  
Lifting capacities may vary depending on hook used or with / without auxiliary sheave.  
Please refer rated chart in operator's cabin.  
Please refer Page 21 for Crane Boom Supplemental Data.

## Heavy Fixed Jib (Type B1) Lifting Capacities

Unit: ton

Counterweight: 200.0 ton, Carbody weight: 50.0 ton  
HL Mast point radius: 11 m

Working Radius (m)	18.0			Working Radius (m)
	Boom Length (m)	Working Radius (m)	Boom Length (m)	
20.0	120.0	120.0	117.0	20.0
22.0	107.9	107.2	104.8	22.0
24.0	95.5	94.6	93.7	24.0
26.0	85.1	84.2	83.2	26.0
28.0	76.3	75.4	74.4	28.0
30.0	68.8	67.8	66.8	30.0
34.0	56.6	55.6	54.4	34.0
38.0	47.1	46.0	44.9	38.0
42.0	39.5	38.4	37.2	42.0
46.0	33.3	32.2	31.0	46.0
50.0	28.2	27.0	25.8	50.0
54.0	23.8	22.6	21.4	54.0
58.0	20.1	18.9	17.6	58.0
62.0	16.9	15.7	14.4	62.0
66.0	14.1	12.9	11.5	66.0
70.0	11.6	10.4	9.1	70.0
Reeves	10	10	10	Reeves

Note:

Designed and rated to comply with EN13000.

Ratings shown in [ ] are determined by the strength of the boom or other structural components.  
Lifting capacities may vary depending on hook used or with / without auxiliary sheave.  
Please refer rated chart in operator's cabin.  
Ratings enclosed in gray-color box in the table require double-drum specifications.  
Please refer Page 21 for Heavy Fixed Jib Supplemental Data.





## BOOM AND JIB ARRANGEMENTS

### Heavy Duty Crane Boom Arrangements

Boom length m (ft)	Boom arrangement
36 (118)	※ L   6.0   12.0   8T   HU
42 (138)	※ L   6.0   6.0   12.0   8T   HU L   12.0   12.0   8T   HU
48 (157)	※ L   12.0   12.0   6.0   8T   HU
54 (177)	※ L   6.0   6.0   12.0   12.0   8T   HU L   12.0   12.0   12.0   8T   HU
60 (197)	※ L   12.0   12.0   6.0   12.0   8T   HU
66 (217)	※ L   6.0   6.0   12.0   12.0   12.0   8T   HU L   12.0   12.0   12.0   12.0   8T   HU
72 (236)	※ L   12.0   12.0   6.0   12.0   12.0   8T   HU
78 (256)	※ L   6.0   6.0   12.0   12.0   12.0   12.0   8T   HU L   12.0   12.0   12.0   12.0   12.0   8T   HU
84 (276)	※ L   12.0   12.0   6.0   12.0   12.0   12.0   8T   HU

Symbol	Boom Length	Remarks
L	9.0 m (29.5 ft)	Boom Base
8T	8.0 m (26.2 ft)	Tapered Boom
6.0	6.0 m (19.7 ft)	Insert Boom
12.0	12.0 m (39.4 ft)	Insert Boom
HU	1.0 m (3.3 ft)	Boom Top

※ indicates the most flexible combination of insert heavy duty booms, which can be modified to form all shorter heavy duty boom arrangements.

### Long Boom Arrangements

Boom length m (ft)	Boom arrangement
90 (295)	L   12.0   12.0   6.0   12.0   12.0   8T   5LT   6.0L   UL
96 (315)	※ L   12.0   12.0   6.0   12.0   12.0   8T   5LT   6.0L   6.0L   UL L   12.0   12.0   6.0   12.0   12.0   8T   5LT   12.0L   UL
102 (335)	※ L   6.0   6.0   12.0   12.0   12.0   12.0   8T   5LT   6.0L   6.0L   UL L   12.0   12.0   12.0   12.0   12.0   8T   5LT   6.0L   6.0L   UL L   6.0   6.0   12.0   12.0   12.0   12.0   8T   5LT   12.0L   UL
108 (354)	※ L   6.0   6.0   12.0   12.0   12.0   12.0   8T   5LT   6.0L   12.0L   UL L   12.0   12.0   12.0   12.0   12.0   8T   5LT   6.0L   12.0L   UL
114 (374)	※ L   12.0   12.0   6.0   12.0   12.0   12.0   8T   5LT   6.0L   12.0L   UL
120 (394)	※ L   12.0   12.0   6.0   12.0   12.0   12.0   8T   5LT   6.0L   6.0L   12.0L   UL L   12.0   12.0   6.0   12.0   12.0   12.0   8T   5LT   12.0L   12.0L   UL
126 (413)	※ L   12.0   12.0   6.0   12.0   12.0   12.0   8T   5LT   6.0L   12.0L   12.0L   UL

Symbol	Boom Length	Remarks
L	9.0 m (29.5 ft)	Boom Base
8T	8.0 m (26.2 ft)	Tapered Boom
6.0	6.0 m (19.7 ft)	Insert Boom
12.0	12.0 m (39.4 ft)	Insert Boom
5LT	5.0 m (16.4 ft)	Luffing Insert Jib
6.0L	6.0 m (19.7 ft)	Luffing Insert Jib
12.0L	12.0 m (39.4 ft)	Luffing Insert Jib
UL	8.0 m (26.2 ft)	Luffing Top

※ indicates the most flexible combination of insert long booms, which can be modified to form all shorter long boom arrangements.

### Luffing Boom Arrangements for Crane

Boom length m (ft)	Boom arrangement
36 (118)	※ L   6.0   12.0   8T   LU
42 (138)	※ L   6.0   12.0   6.0   8T   LU L   12.0   12.0   8T   LU
48 (157)	※ L   12.0   12.0   6.0   8T   LU
54 (177)	※ L   6.0   6.0   12.0   12.0   8T   LU L   12.0   12.0   12.0   8T   LU
60 (197)	※ L   12.0   12.0   6.0   12.0   8T   LU
66 (217)	※ L   6.0   6.0   12.0   12.0   12.0   8T   LU L   12.0   12.0   12.0   12.0   8T   LU
72 (236)	※ L   12.0   12.0   6.0   12.0   12.0   8T   LU
78 (256)	※ L   6.0   6.0   12.0   12.0   12.0   12.0   8T   LU L   12.0   12.0   12.0   12.0   12.0   8T   LU
84 (276)	※ L   12.0   12.0   6.0   12.0   12.0   12.0   8T   LU

Symbol	Boom Length	Remarks
L	9.0 m (29.5 ft)	Boom Base
8T	8.0 m (26.2 ft)	Tapered Boom
6.0	6.0 m (19.7 ft)	Insert Boom
12.0	12.0 m (39.4 ft)	Insert Boom
LU	1.0 m (3.3 ft)	Boom Top

※ indicates the most flexible combination of insert luffing booms, which can be modified to form all shorter luffing boom arrangements.

## BOOM AND JIB ARRANGEMENTS

### Heavy Fixed Jib Boom Arrangements (Type B2)

Boom length m (ft)	Boom arrangement
66 (217)	※
72 (236)	※
78 (256)	※

Symbol	Boom Length	Remarks
	9.0 m (29.5 ft)	Boom Base
	8.0 m (26.2 ft)	Tapered Boom
	6.0 m (19.7 ft)	Insert Boom
	12.0 m (39.4 ft)	Insert Boom
	1.0 m (3.3 ft)	Boom Top

↗ mark shows the guy line installing position when the fixed jib is used.  
 ※ indicates the most flexible combination of insert luffing booms, which can be modified to form all shorter luffing boom arrangements.

### Heavy Fixed Jib Arrangements (Type B2)

Jib length m (ft)	Jib arrangement
18 (59)	

Symbol	Jib Length	Remarks
	10.0 m (32.8 ft)	Jib Base
	8.0 m (26.2 ft)	Jib Top

### Luffing Boom Arrangements for Luffing

Boom length m (ft)	Boom arrangement
36 (118)	※
42 (138)	※
48 (157)	※
54 (177)	※
60 (197)	※
66 (217)	※
72 (236)	※
78 (256)	※
84 (276)	※

Symbol	Boom Length	Remarks
	9.0 m (29.5 ft)	Boom Base
	8.0 m (26.2 ft)	Tapered Boom
	6.0 m (19.7 ft)	Insert Boom
	12.0 m (39.4 ft)	Insert Boom
	1.0 m (3.3 ft)	Boom Top

※ indicates the most flexible combination of insert luffing booms, which can be modified to form all shorter luffing boom arrangements.

### Heavy Fixed Jib Boom Arrangements (Type C)

Boom length m (ft)	Boom arrangement
84 (276)	※
90 (296)	※
96 (316)	※
102 (336)	※

Symbol	Boom Length	Remarks
	9.0 m (29.5 ft)	Boom Base
	8.0 m (26.2 ft)	Tapered Boom
	6.0 m (19.7 ft)	Insert Boom
	12.0 m (39.4 ft)	Insert Boom
	1.0 m (3.3 ft)	Boom Top

↗ mark shows the guy line installing position when the fixed jib is used.  
 ※ indicates the most flexible combination of insert heavy duty booms, which can be modified to form all shorter heavy duty boom arrangements.

### Luffing Jib Arrangements

Jib length m (ft)	Jib arrangement
24 (79)	
30 (98)	※
36 (118)	※
42 (136)	※
48 (157)	※
54 (177)	※
60 (197)	※
66 (217)	※
72 (236)	※
78 (256)	※
84 (276)	※

Symbol	Jib Length	Remarks
	10.0 m (32.8 ft)	Jib Base
	6.0 m (19.7 ft)	Luffing Insert Jib
	12.0 m (39.4 ft)	Luffing Insert Jib
	8.0 m (26.2 ft)	Jib Top

※ indicates the most flexible combination of insert luffing jibs, which can be modified to form all shorter luffing jib arrangements.

### Heavy Fixed Jib Arrangements (Type C)

Jib length m (ft)	Jib arrangement
18 (59)	

Symbol	Jib Length	Remarks
	10.0 m (32.8 ft)	Jib Base
	8.0 m (26.2 ft)	Jib Top

### SHL MAST

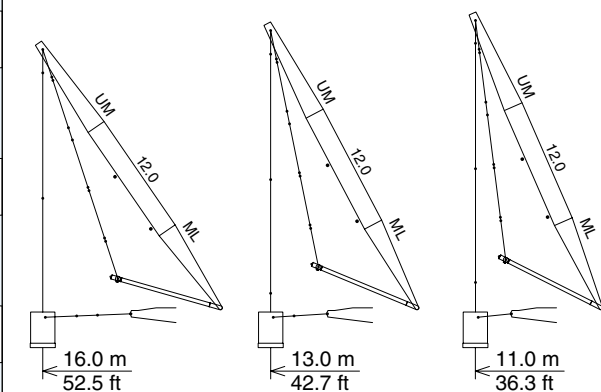

Symbol	Mast Length	Remarks
	9.0 m (29.5 ft)	Mast Base
	12.0 m (39.4 ft)	Insert Mast
	9.0 m (29.5 ft)	Mast Top

## WORKING RANGES

### Heavy Duty Crane Boom

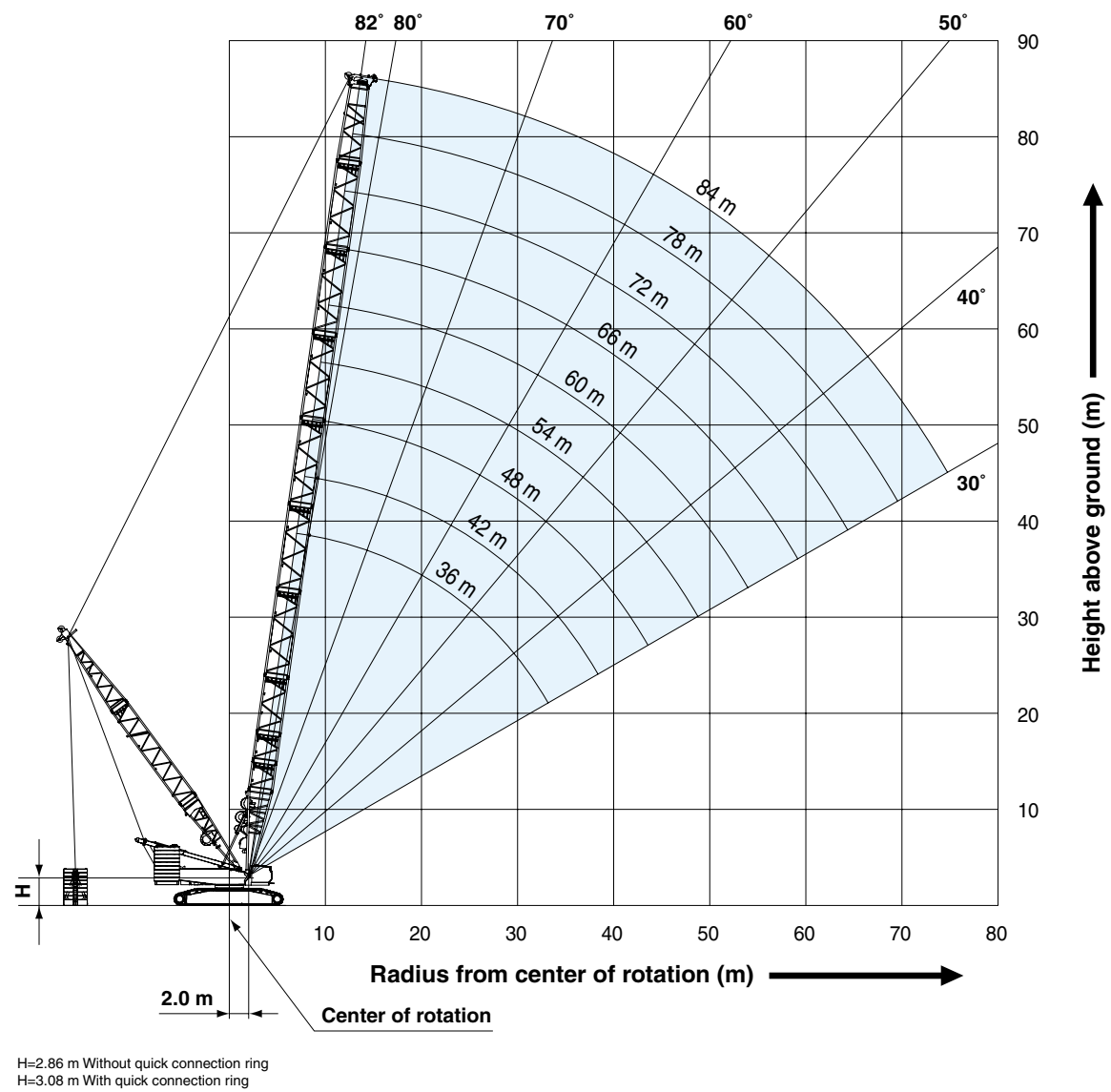

### Luffing Boom

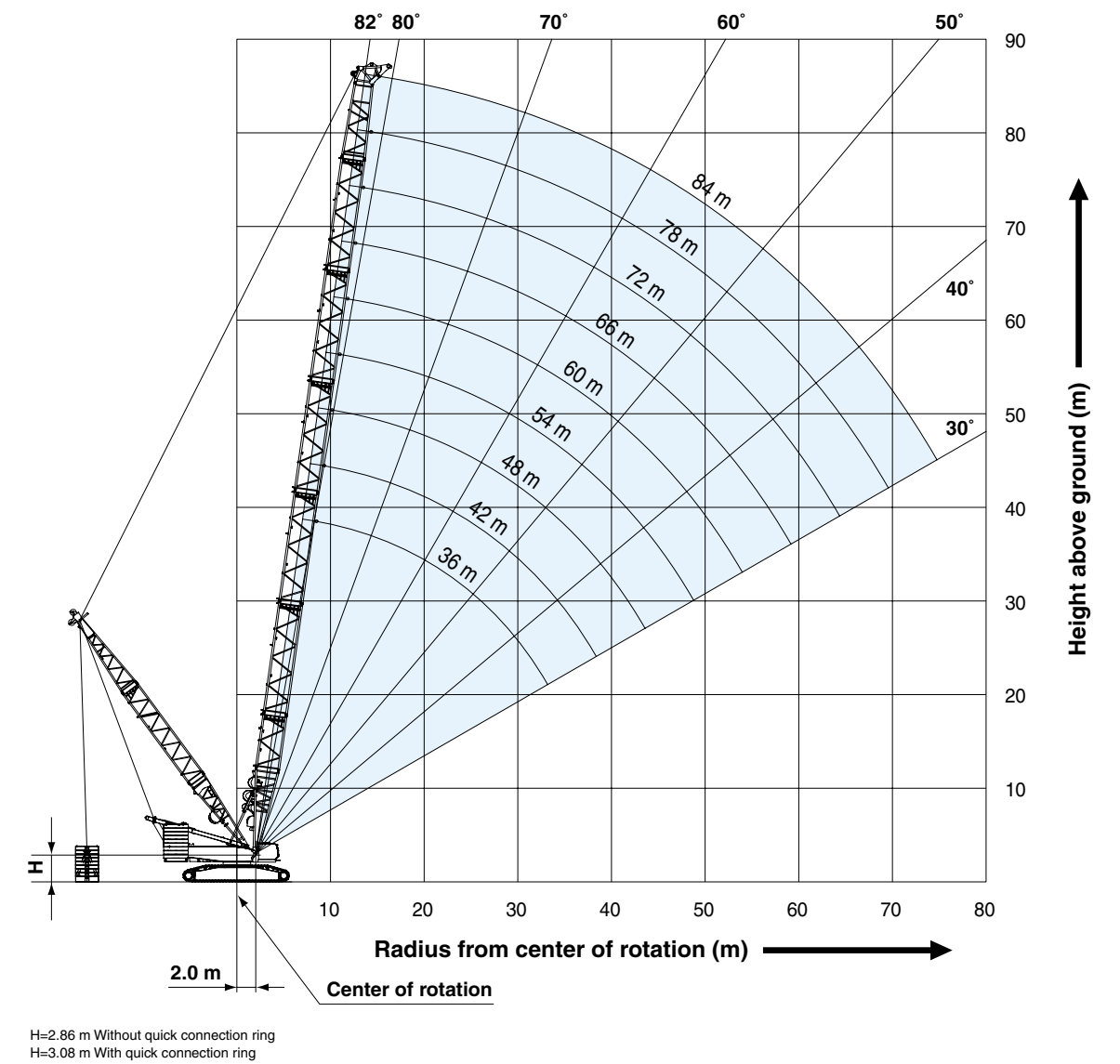

## WORKING RANGES

### Long Boom

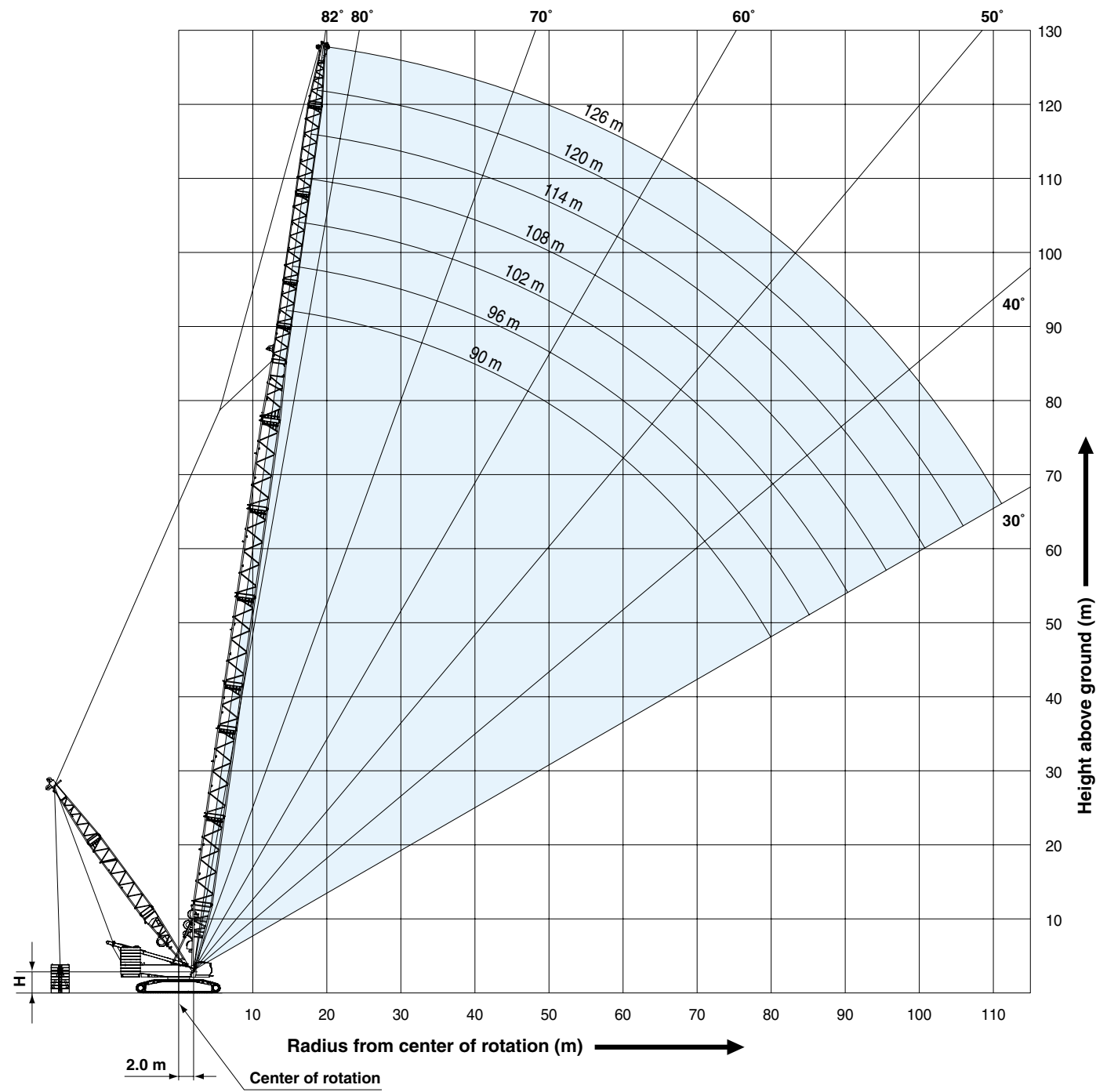

H=2.86 m Without quick connection ring  
H=3.08 m With quick connection ring

55 **SL6000G**

### Heavy Fixed Jib (Type B2)

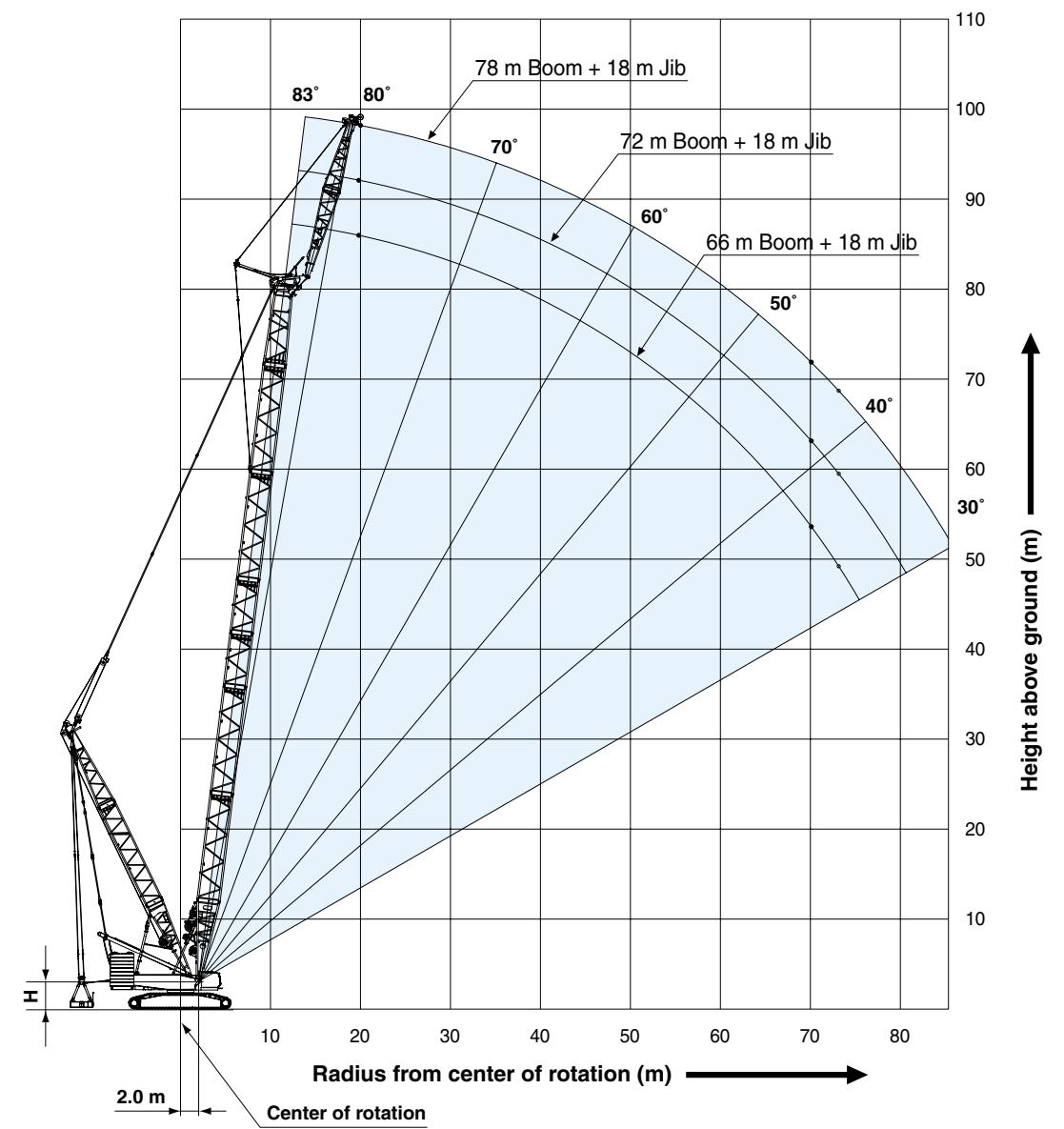

H=2.86 m Without quick connection ring  
H=3.08 m With quick connection ring



## WORKING RANGES

### Heavy Fixed Jib (Type C)

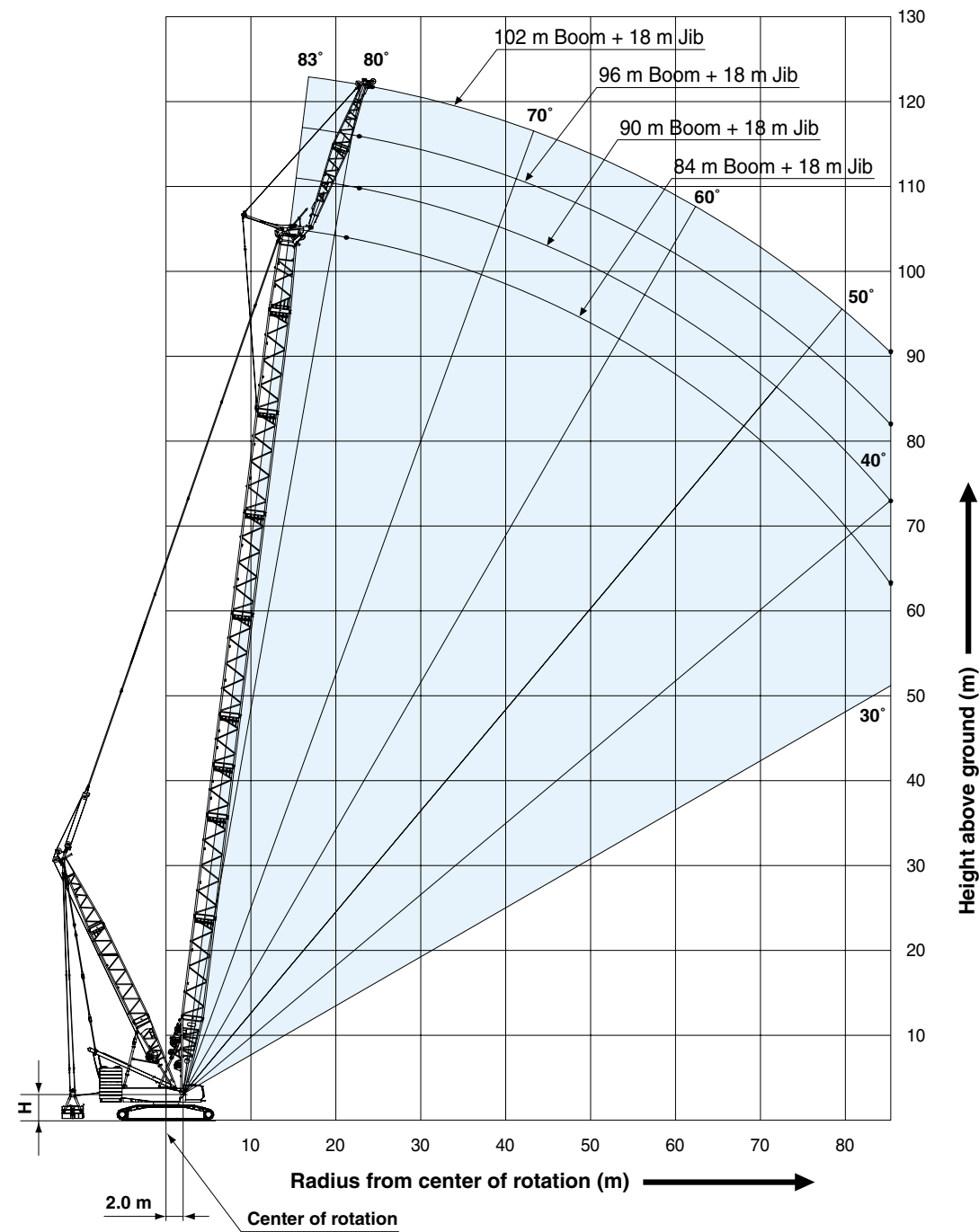

H=2.86 m Without quick connection ring  
H=3.08 m With quick connection ring

### Luffing Jib Boom Angle: 86°

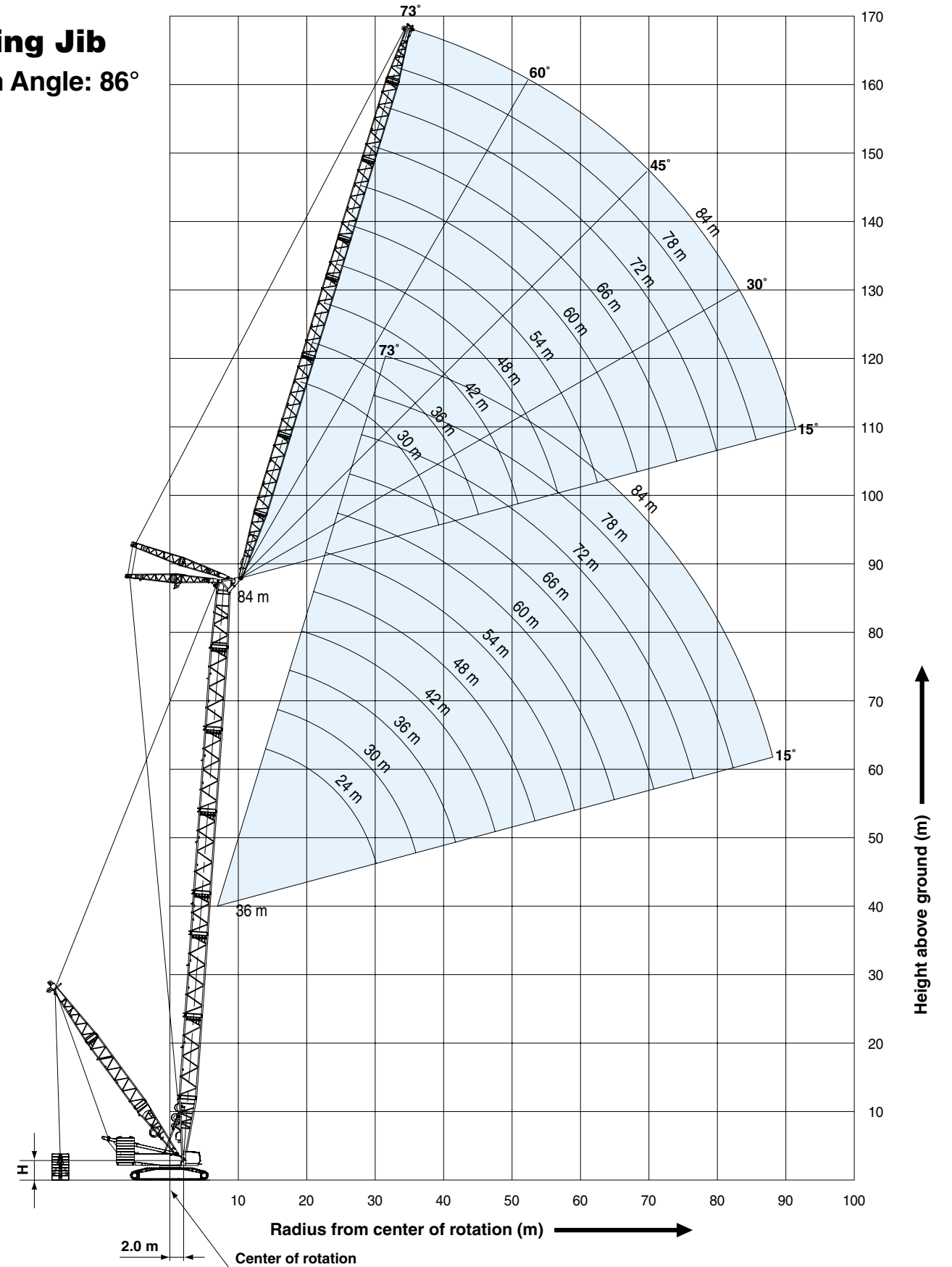

H=2.86 m Without quick connection ring  
H=3.08 m With quick connection ring

## WORKING RANGES

**Luffing Jib**  
Boom Angle:  
76°

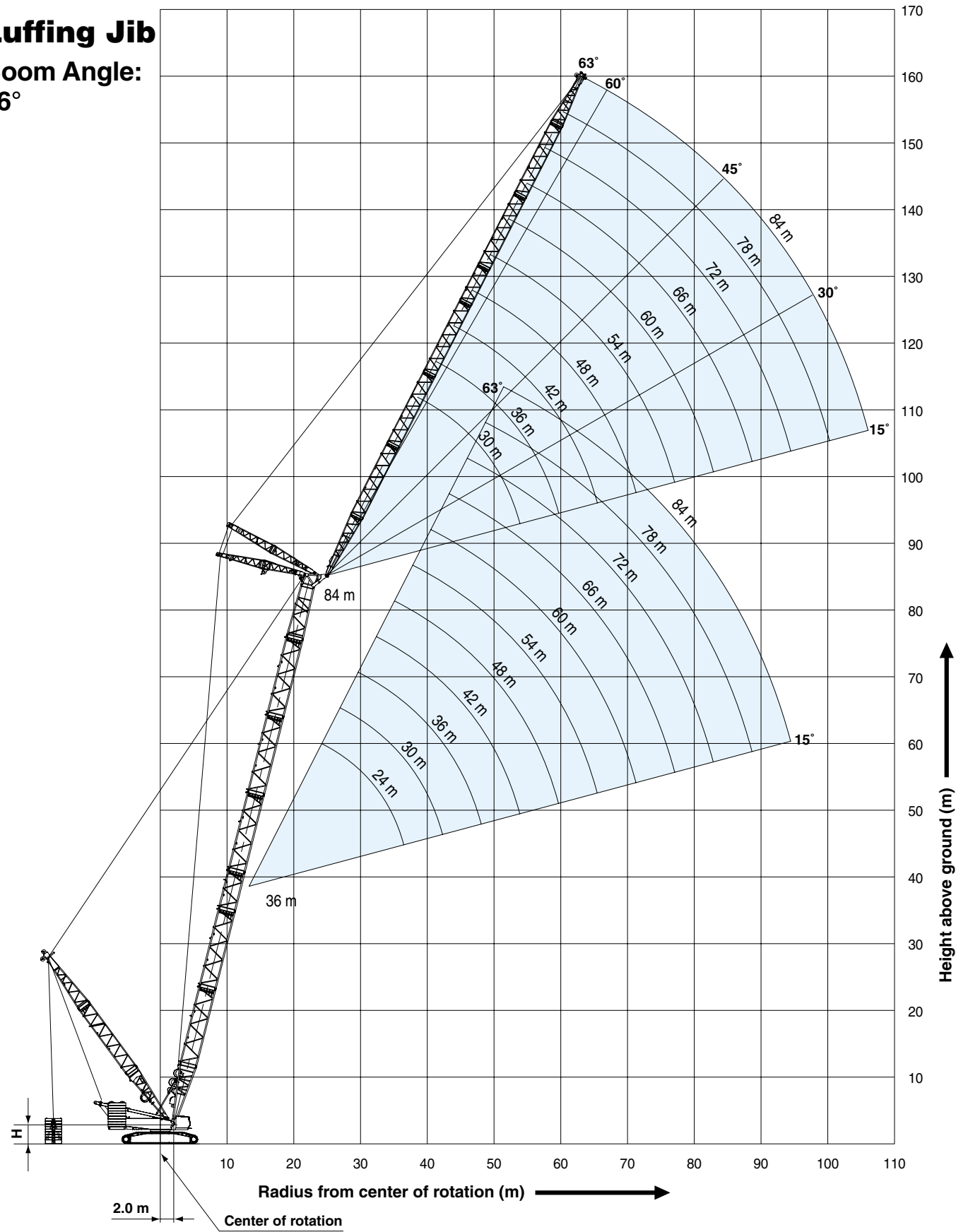

H=2.86 m Without quick connection ring  
H=3.08 m With quick connection ring

**Luffing Jib**  
Boom Angle:  
66°

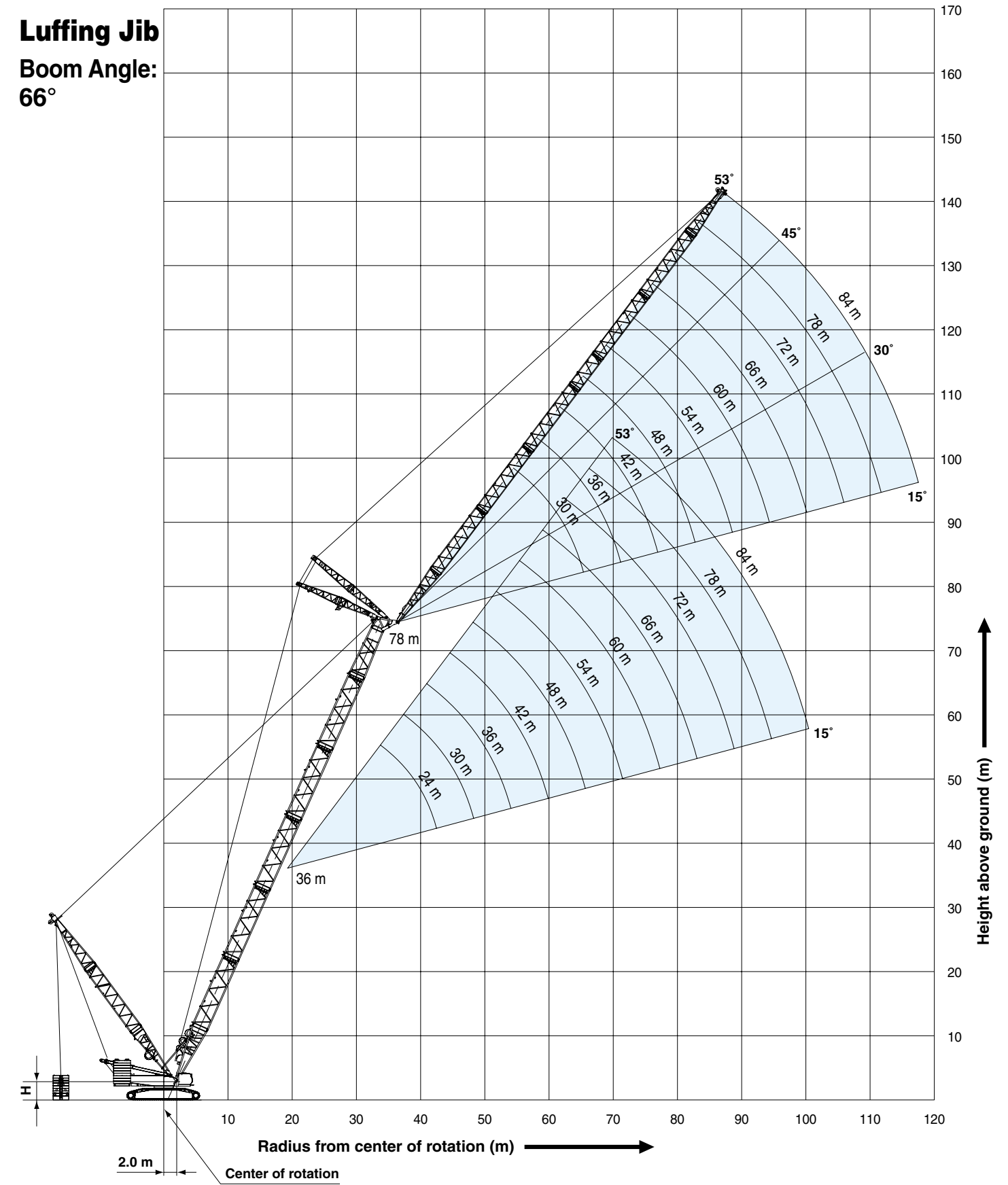

H=2.86 m Without quick connection ring  
H=3.08 m With quick connection ring

















## LIFTING CAPACITIES Luffing Jib Lifting Capacity

Unit: ton

Counterweight: 200.0 ton, Carbody weight: 50.0 ton  
Pallet weight: 130.0 ton x 16 m

84.0 m Boom Length		84.0																Boom length (m)			
		30.0		36.0		42.0		48.0		54.0		60.0		66.0		72.0		78.0		Jib length (m)	
Working Radius (m)		Boom angle		86°		76°		86°		76°		86°		76°		86°		76°		Boom angle	
				21.4	104.6																
		22.0	101.9																		22.0
		24.0	94.3					83.3													24.0
		26.0	87.4			87.8		81.0		71.5											26.0
		28.0	81.3			81.8		78.6		69.8		62.4									28.0
		30.0	75.8			76.4		76.0		67.9		61.0		54.5							30.0
		34.0	66.0			67.0		67.2		63.8		58.0		52.2		45.8		41.4		36.5	34.0
		38.0	57.5			59.1		59.6		59.6		54.6		49.6		43.8		39.9		35.4	38.0
		42.0		83.4	52.2	83.7		53.0		53.2		51.3		46.9		41.7		38.3		34.1	42.0
		46.0		72.4		73.1	47.2	73.0	47.6		47.5		44.2		39.6		36.5		32.8		46.0
		50.0		63.1		64.2	41.9	64.4	42.7	64.2	42.8	63.7	41.6		37.4		34.7		31.3		50.0
		54.0		54.7		56.7		57.1	38.3	57.1	38.6	56.7	38.5	56.2	35.4		33.0		29.9		54.0
		58.0				50.0		50.9		51.0	34.7	50.7	34.9	50.4	33.4	49.3	31.2	44.4	28.4		58.0
		62.0						45.4		45.8	31.1	45.6	31.6	45.3	30.4	44.2	29.6	43.6	27.0	38.5	62.0
		66.0								41.1		41.1	28.5	40.9	27.5	40.9	27.1	39.2	25.6	38.0	66.0
		70.0								36.8		37.1		37.0	24.8	38.4	24.5	37.2	24.0	34.7	70.0
		74.0										33.4		33.5	22.2	36.0	22.2	35.2	21.7	33.1	74.0
		78.0												30.4		33.5	19.9	33.0	19.6	31.6	78.0
		82.0												27.4		29.6		30.6	17.6	29.8	82.0
		86.0														25.6		27.1		27.8	86.0
		90.0																23.7		24.8	90.0
		94.0																20.0		21.8	94.0
		98.0																		17.7	98.0
		Reeves																			Reeves
			8			8				8											8

Note: Designed and rated to comply with EN13000.

Ratings shown in   are determined by the strength of the boom or other structural components.

Lifting capacities may vary depending on hook used or with / without auxiliary sheave.

Please refer rated chart in operator's cabin.

Ratings enclosed in gray color box in the table require duple-drum specifications.

Please refer Page 23 to 25 for Luffing Jib Supplemental Data.

## Base Machine

### Base machine (A)

With

- Upper/Lower connecting device
- Crane mast
- Mast raising cylinder
- Carbody
- Lower translifter

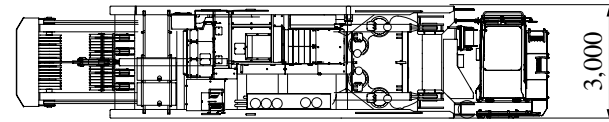

Weight 63,530 kg  
Width 3.0 m  
Height 3.4 m  
(Machine)  
Length 14.25 m

Without

- Upper translifter
- Aux. platform
- Boom foot pin removal cylinder
- Reeving winch

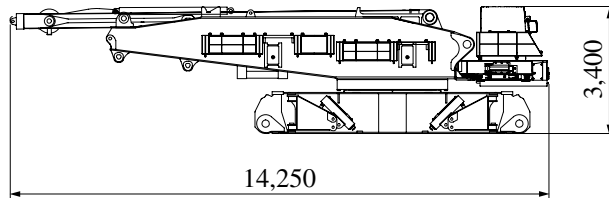

### Base machine (B)

With

- Upper/Lower connecting device
- Carbody
- Lower translifter

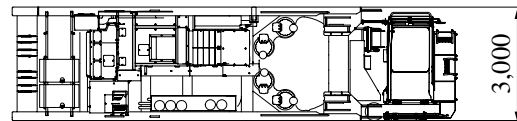

Weight 51,220 kg  
Width 3.0 m  
Height 3.4 m  
(Machine)  
Length 11.87 m

Without

- Crane mast
- Mast raising cylinder
- Upper translifter
- Aux. platform
- Boom foot pin removal cylinder
- Reeving winch

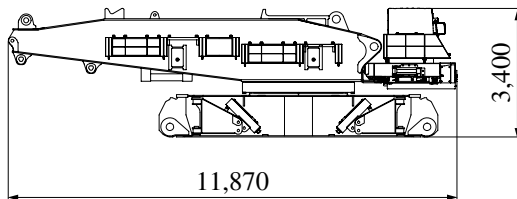

### Base machine (C)

With

- Carbody

Without

- Upper/Lower connecting device
- Crane mast
- Mast raising cylinder
- Upper translifter
- Lower translifter
- Aux. platform
- Boom foot pin removal cylinder
- Reeving winch

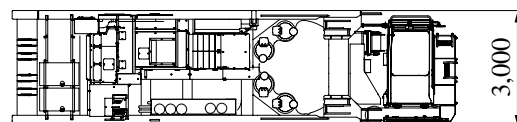

Weight 48,810 kg  
Width 3.0 m  
Height 3.4 m  
(Machine)  
Length 11.87 m

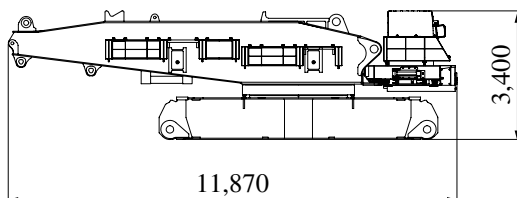

## Upper Structure

### Upper Structure (A)

With

- Upper/Lower connecting device (Upper)
- Crane mast
- Mast raising cylinder

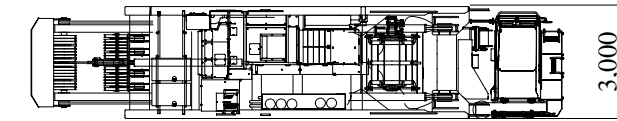

Weight 44,310 kg  
Width 3.0 m  
Height 2.37 m  
(Machine)  
Length 14.25 m

Without

- Upper translifter
- Lower translifter
- Aux. platform
- Boom foot pin removal cylinder
- Reeving winch
- Carbody

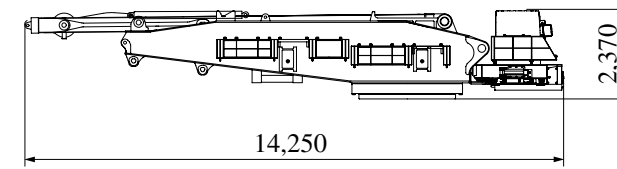

### Upper Structure (B)

With

- Upper/Lower connecting device (Upper)
- Crane mast
- Mast raising cylinder
- Upper translifter

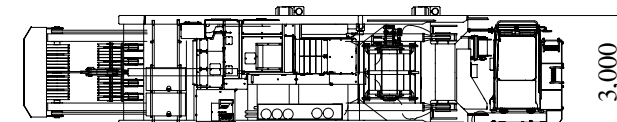

Weight 46,730 kg  
Width 3.0 m  
Height 2.37 m  
(Machine)  
Length 14.45 m

Without

- Aux. platform
- Boom foot pin removal cylinder
- Reeving winch
- Carbody
- Lower translifter

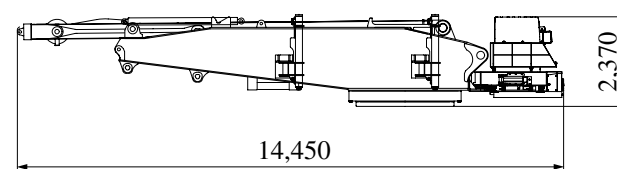

### Upper Structure (C)

With

- Upper/Lower connecting device (Upper)
- Crane mast
- Mast raising cylinder
- Upper translifter

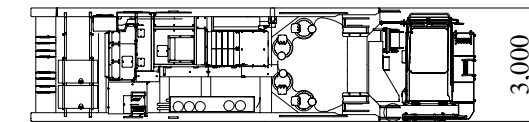

Weight 32,000 kg  
Width 3.0 m  
Height 2.37 m  
(Machine)  
Length 11.87 m

Without

- Aux. platform
- Boom foot pin removal cylinder
- Reeving winch
- Carbody
- Lower translifter

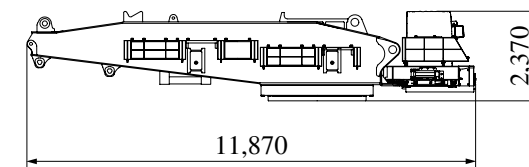

### Base Machine (A)

With upper/lower connecting devices, crane mast, mast raising cylinder, Carbody, lower transflifer.  
Weight: 63,530 kg Width: 3,000 mm

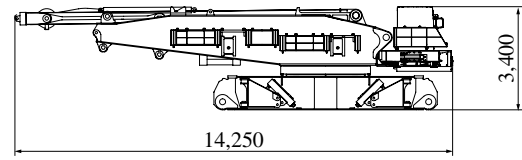

### Carbody

With upper/lower connecting devices.  
Weight: 22,610 kg Width: 2,990 mm

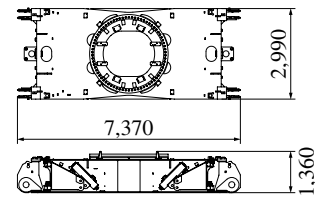

### Crawler frame

Weight: 40,000 kg Width: 1,500 mm

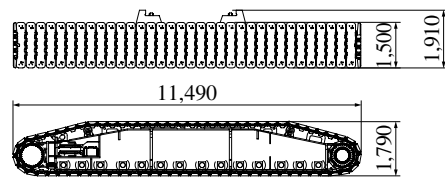

### Crane Mast

Weight: 12,310 kg

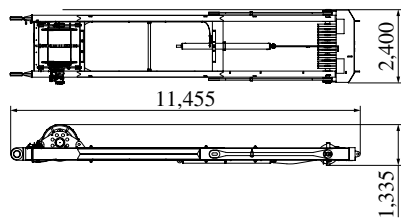

### Base Counterweight

Weight: 20,000 kg

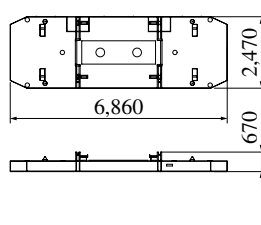

### Base Carbody Weight (5 t)

(with link)  
Weight: 5,400 kg

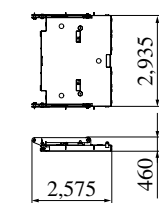

### 9 m Boom Base

With H1, H2 and W2 winches including ropes, guide sheave, and boom backstop  
Weight: 28,440 kg

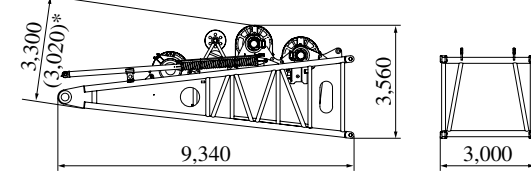

\* When the H1 drum winch is stowed.

### 6 m Boom Insert

With 6 m guy line (link) x 4  
Weight: 3,740 kg

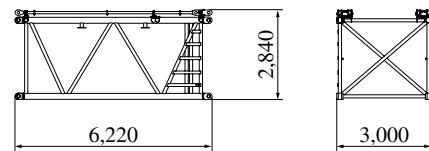

### 12 m Boom Insert

With 12 m guy line (link) x 4  
Weight: 6,740 kg

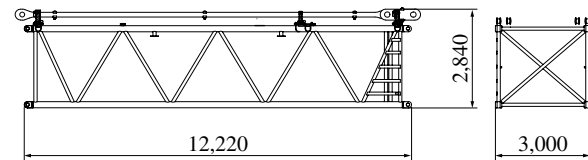

### 8 m Tapered Boom

With 8 m guy line (link) x 2  
Weight: 5,210 kg

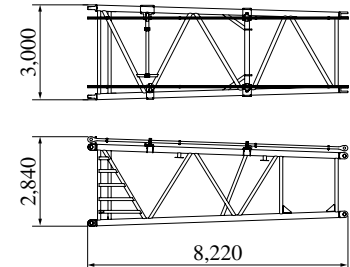

Dimensions: mm Weight: kg

### Heavy Boom Tip

Weight: 4,910 kg

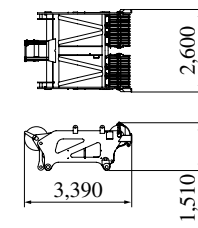

### Luffing Boom Tip

Weight: 5,520 kg

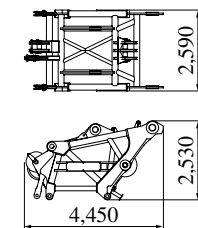

### 10 m Mast Base

Weight: 13,700 kg

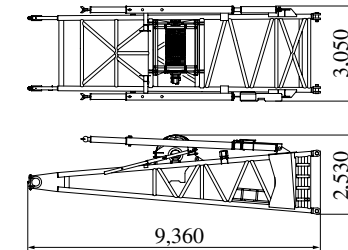

### 12 m Mast Insert

With guy line  
Weight: 5,650 kg

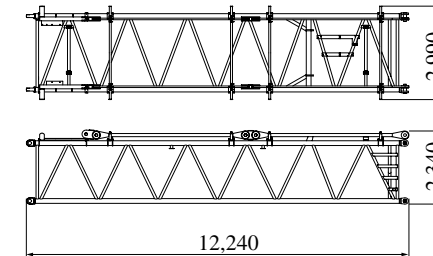

### 9 m Mast top

With guy line  
Weight: 10,080 kg

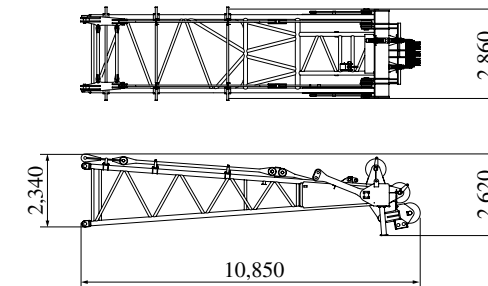

### Hanger sheave

Weight: 2,010 kg

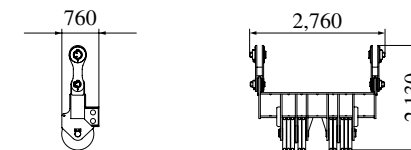

### 550 t Hook

Weight: 11,730 kg

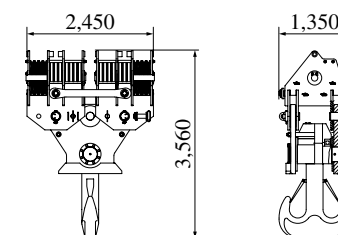

Dimensions: mm Weight: kg

### 300 t Hook

Weight: 7,870 kg

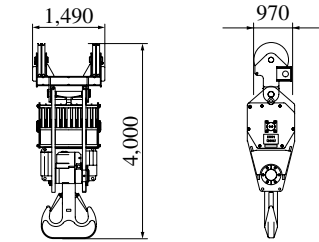

### 200 t Hook

Weight: 7,100 kg

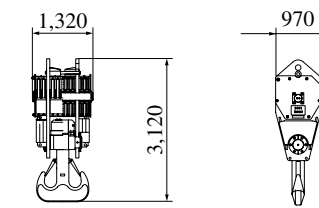

### 120 t Hook

Weight: 4,500 kg

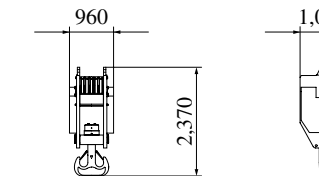

### 70 t Hook

Weight: 3,100 kg

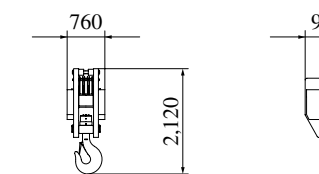

### 40 t Hook

Weight: 2,000 kg

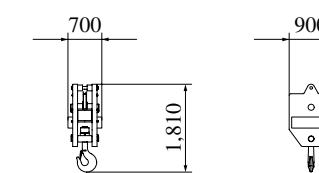

### Ball hook

Weight: 830 kg

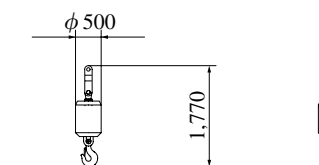

# PARTS AND ATTACHMENTS

Dimensions: mm Weight: kg

**5 m boom insert for long boom**  
Weight: 1,790 kg

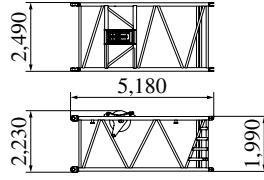

**10 m Jib Base**  
Weight: 3,780 kg

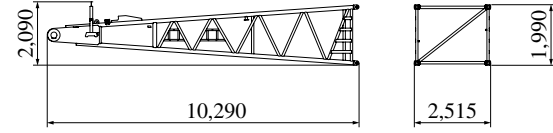

**6 m Jib Insert**  
Weight: 1,470 kg

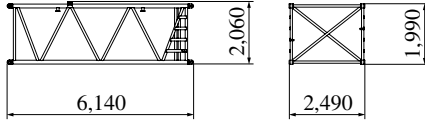

**12 m Jib Insert**  
Weight: 2,680 kg

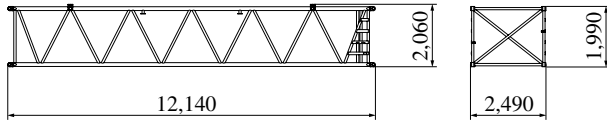

**8 m Jib Top**  
Weight: 3,690 kg

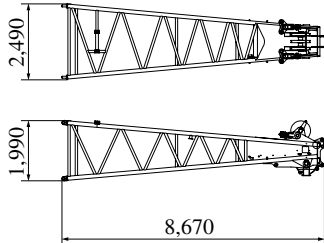

**Strut (For Heavy Fixed Jib)**  
With guy cable  
Weight: 1,510 kg

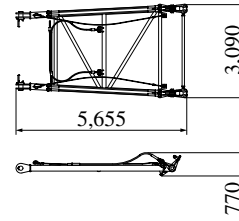

**Rear strut base**  
Weight: 1,990 kg

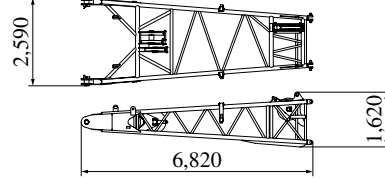

**Rear strut tip**  
Weight: 2,410 kg

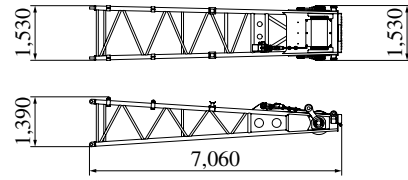

**Front strut base**  
Weight: 1,840 kg

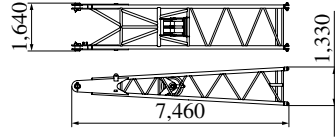

**Front strut top**  
Weight: 3,040 kg

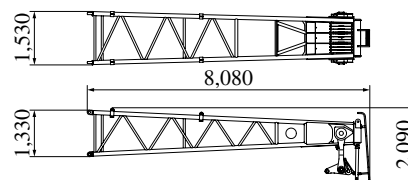

**Auxiliary sheave**  
Weight: 650 kg

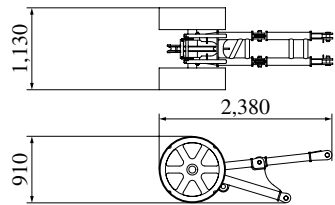

---

---

---

---

---

---

---

---

---

---

---

---

---

---

---

---

---

---

---

---

---

---

---

---

---

---