

D
1
5
5

NET HORSEPOWER

354 HP @ 1900rpm
264 kW @ 1900rpm

OPERATING WEIGHT

87,100 lb
39500 kg

BLADE CAPACITY

SIGMADOZER
12.3 yd³ 9.4 m³

Full-U Dozer
15.6 yd³ 11.9 m³



PHOTOS MAY INCLUDE OPTIONAL EQUIPMENT

D155AX-7

WALK-AROUND

D155AX-7



Photos may include optional equipment

D155AX-7

Tier 4 Interim Engine

NET HORSEPOWER
354 HP @ 1900rpm
264 kW @ 1900rpm

OPERATING WEIGHT
87,100 lb
39500 kg

BLADE CAPACITY
SIGMADOZER
12.3 yd³ 9.4 m³

Full-U Dozer
15.6 yd³ 11.9 m³



OUTSTANDING PRODUCTIVITY & FUEL ECONOMY

Innovative SIGMADOZER reduces digging resistance and smoothly rolls material up for increased blade loads.

Automatic transmission with lockup torque converter improves fuel consumption.

Blade capacity:
12.3 yd³ 9.4 m³



SAA6D140E-6 variable geometry turbocharged and aftercooled 15.24 liter diesel engine provides excellent fuel economy. This engine is EPA Tier 4 Interim and EU Stage 3B emissions certified.

Komatsu Variable Geometry Turbocharger (KVG T) uses a hydraulic actuator to provide optimum air flow under all speed and load conditions.

Komatsu Diesel Particulate Filter (KDPF) captures 90% of particulate matter and provides automatic regeneration that does not interfere with daily operation.

Rear hydraulics (standard)

Rear view monitoring system (standard)

Advanced diagnostic system continuously monitors machine operation and vital systems to identify machine issues and assist with troubleshooting.

Integrated ROPS cab features:

- Large, quiet, and pressurized cab
- Excellent visibility with integrated ROPS structure
- New heated air-ride seat with 15% higher capacity

Hydrostatic Steering System (HSS) provides smooth, quick, and powerful control in various ground conditions. (Counter-rotation is available when in neutral.)

Complete operator control

- Palm Command Control System (PCCS)
- Automatic/manual shift selectable mode
- Shift pattern preset function

Extra-low machine profile provides excellent machine balance and low center of gravity.

Large color monitor

- Easy-to-read and use large 7" high-resolution multi-color monitor
- ECO guidance

K-Bogie undercarriage system

improves traction, component durability, and operator comfort.

KOMTRAX®

Komtrax equipped machines can send location, SMR and operation maps to a secure website utilizing wireless technology. Machines also relay error codes, cautions, maintenance items, fuel levels, and much more.

PRODUCTIVITY & ECOLOGY FEATURES

D155AX-7

Environment-Friendly Engine

The Komatsu SAA6D140E-6 engine is EPA Tier 4 Interim and EU Stage 3B emissions certified and provides exceptional performance while reducing fuel consumption. Based on Komatsu proprietary technologies developed over many years, this new diesel engine reduces exhaust gas particulate matter (PM) by more than 90% and nitrogen oxide (NOx) by more than 45%, compared to Tier 3 levels. Through the in-house development and production of engines, electronics, and hydraulic components, Komatsu has achieved great advancements in technology providing high levels of performance and efficiency in virtually all applications.

Komatsu Variable Geometry Turbocharger (KVGTT)

Using Komatsu proprietary technology, a newly designed variable geometry turbocharger with a hydraulic actuator is used to manage and deliver optimum air flow to the combustion chamber under all speed and load conditions. The robust hydraulic actuator provides power and precision, resulting in cleaner exhaust gas and improved fuel economy while maintaining performance.

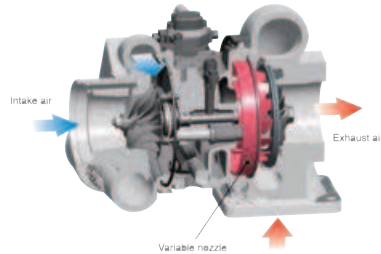

Advanced Electronic Control System

The engine control system has been upgraded to effectively manage a variety of parameters such as the air flow rate, EGR gas flow rate, fuel injection parameters, and aftertreatment functions. The new control system also provides enhanced diagnostic capabilities.

Cooled Exhaust Gas Recirculation (EGR)

Cooled EGR, a technology that has been well proven in Komatsu Tier 3 engines, reduces NOx emission to meet Tier 4 levels. The hydraulically-actuated EGR system has increased capacity and uses larger and more robust components to ensure reliability for demanding work conditions.

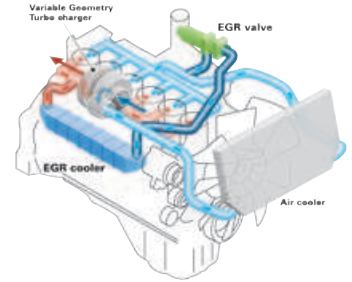

Redesigned combustion chamber

The combustion chamber has a new shape designed to improve combustion and further reduce NOx, PM, fuel consumption, and noise levels.

Closed Crankcase Ventilation (CCV)

Crankcase emissions (blow-by gas) are passed through a CCV filter. The CCV filter traps oil mist which is returned back to the crankcase while the filtered gas is returned to the air intake.

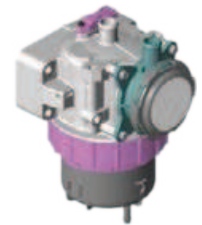

High efficiency fuel filter

A new high efficiency fuel filter improves fuel system reliability. The dual-type filter offers twice the filtration capacity.

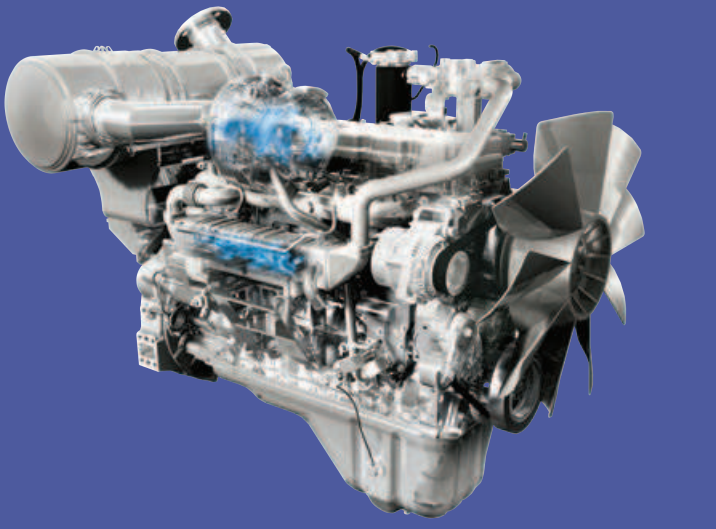

Komatsu Diesel Particulate Filter (KDPF)

Komatsu has developed a high efficiency diesel particulate filter that captures more than 90% of particulate matter. Both passive and active regeneration are automatically initiated by the engine controller depending on the soot level of the KDPF. A special oxidation catalyst with a fuel injection system is used to oxidize and remove particulate matter while the machine is running so the regeneration process will not interfere with daily operation. The operator can also initiate regeneration manually or disable regeneration depending on the work environment.

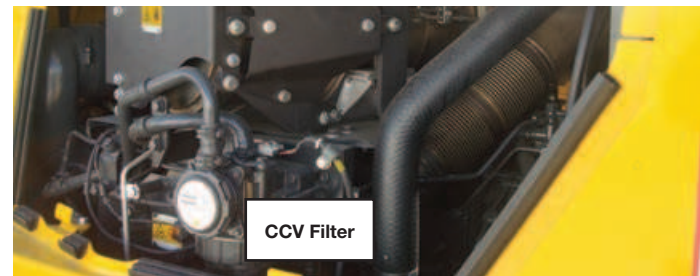
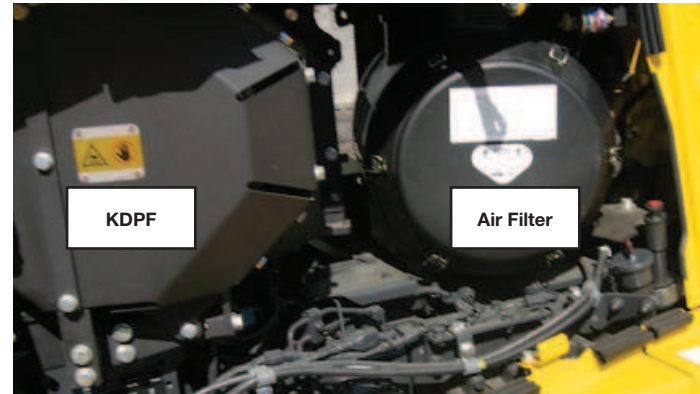
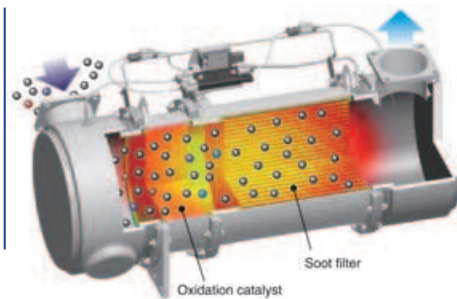

KDPF Regeneration Notification

The LCD color monitor panel provides the operator with the status of the KDPF regeneration without interfering with daily operation. When the machine initiates active regeneration, an icon will notify the operator.



Selectable Working Mode

Working mode E is for general dozing applications with adequate speed and power while reducing fuel consumption and CO₂. Working mode P is aimed at powerful operation and maximum production. The working mode is easily switched on the monitor panel, depending on the work at hand.



Manual Stationary Regeneration

Under most conditions, active regeneration will occur automatically with no effect on machine operation. In case the operator needs to disable active regeneration or initiate a manual stationary regeneration, such as in high-combustible applications, this can be easily accomplished through the monitor panel. The soot level indicator identifies how much soot is trapped in the KDPF.

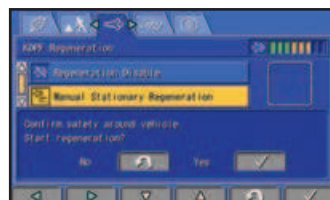

E mode (Economy mode)

With E mode, the engine outputs enough power for most general dozing applications without delivering unnecessary power. This mode allows for energy-saving operation and is suitable for work on ground where the machine may experience shoe slip or applications not requiring large power such as downhill dozing, leveling and light-load work.

P mode (Power mode)

With P mode, the engine outputs its full power, allowing the machine to perform large production, heavy-load, or uphill work.

PRODUCTIVITY & ECOLOGY FEATURES

D155AX-7

Outstanding Productivity

SIGMADOZER – The Next Generation Blade

Based on a completely new digging theory, SIGMADOZER dramatically improves dozing performance and increases productivity. A new frontal design concept adopted for digging and rolling material up at the center of the blade increases soil holding capacity while simultaneously reducing side spillage. It also reduces digging resistance, producing a smoother flow of earth, enabling the dozing of larger quantities of soil with less power.

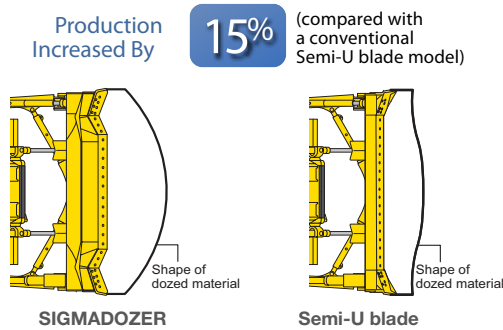

SIGMADOZER



Semi-U blade

Outstanding Fuel Economy

Automatic Transmission with Lockup Torque Converter

A significant reduction in fuel consumption and greater power train efficiency are achieved by the new automatic transmission and lockup torque converter. The automatic transmission selects the optimal gear range depending on the working conditions and load placed on the machine. This means the machine is always operating at maximum efficiency.

The lockup mechanism of the torque converter is automatically actuated to transfer engine power directly to the transmission in travelling and usual dozing speed ranges. Locking up the torque converter results in 10% improved drive train efficiency. Because the electronically controlled Tier 4 Interim engine is extremely efficient, the same low fuel consumption as the D155AX-6 is realized while also maintaining the same machine power.

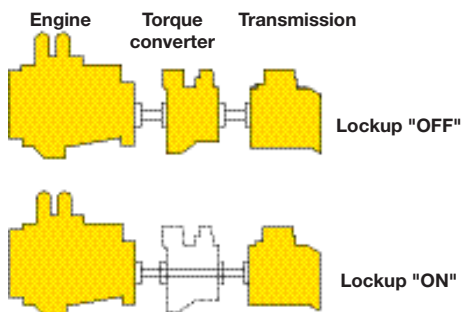

Fuel Consumption Decreased By **10%** (compared with a conventional model)

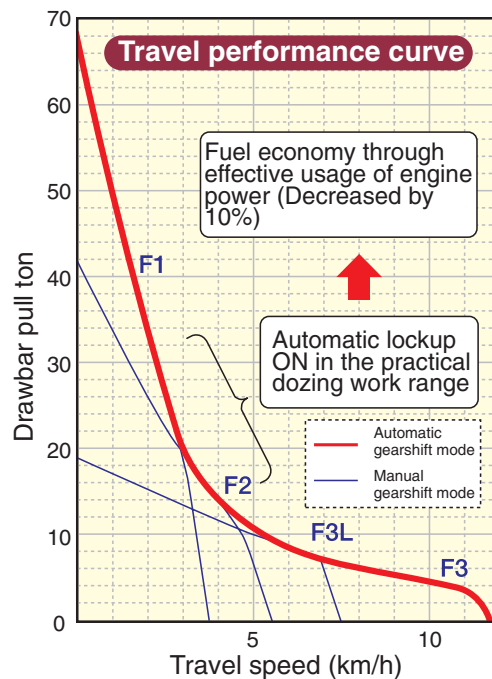

Other Features

Auto Pitch Mode*

To reduce operator effort and increase operating efficiency the new auto blade pitch mode sets blade pitch position between digging and dump positions while dozing. By pressing the auto pitch switch it will toggle the pitch position from digging to dump position with no additional lever movements. The blade pitch control can be set through the monitor to automatically return to the digging position when reverse is selected.

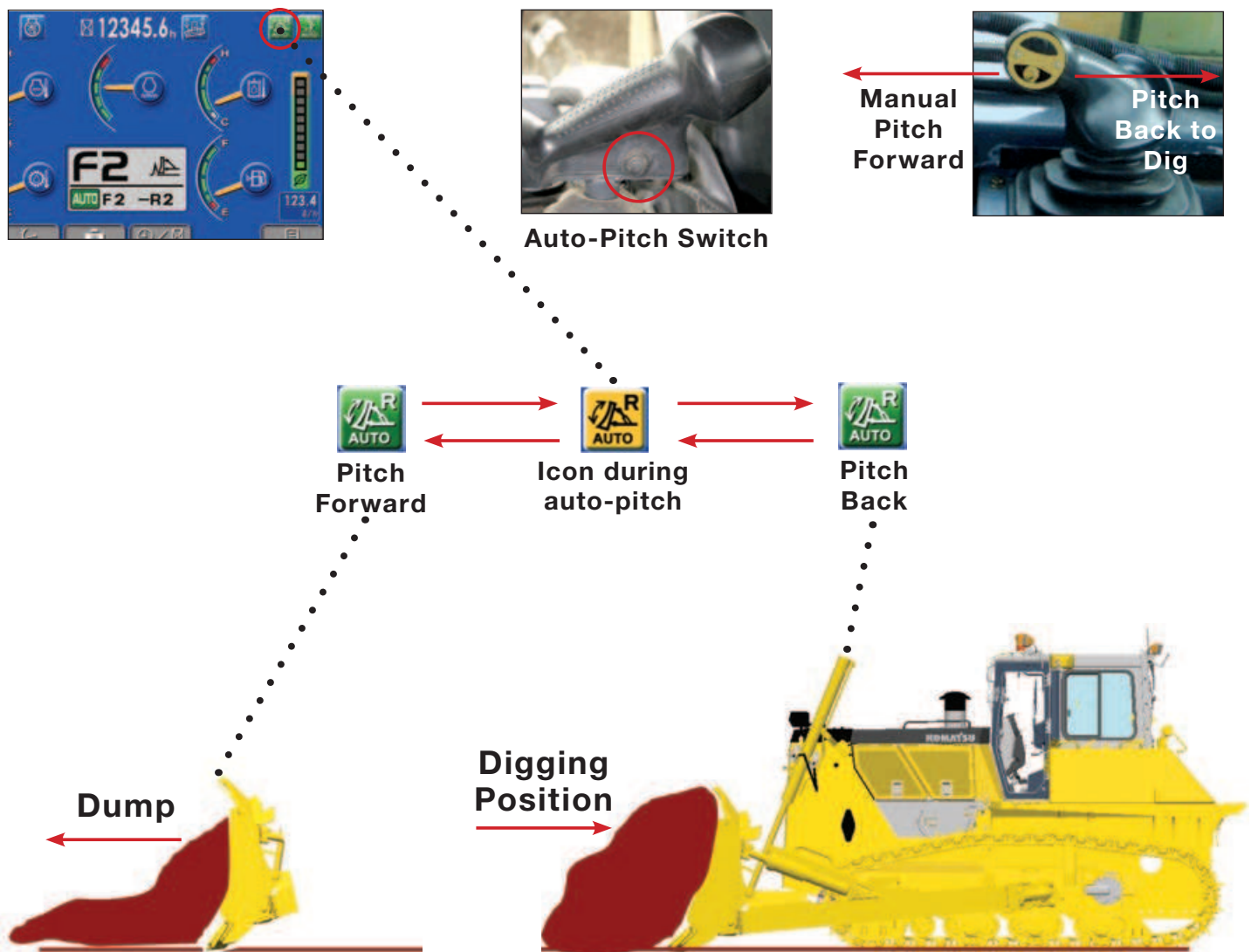

* Requires dual tilt dozer

PRODUCTIVITY & ECOLOGY FEATURES

Other Features

ECO Guidance

In order to support to optimum operation, the following 5 recommendations are displayed to improve fuel saving operation:

- 1) Avoid Excessive Engine Idling
- 2) Use Economy Mode to Save Fuel
- 3) Avoid Hydraulic Relief Pressure
- 4) Avoid Overload
- 5) Use Automatic Shift Mode

The operator can access the ECO guidance menu to check the Operation Records, Eco Guidance Records, and Average Fuel Consumption logs.

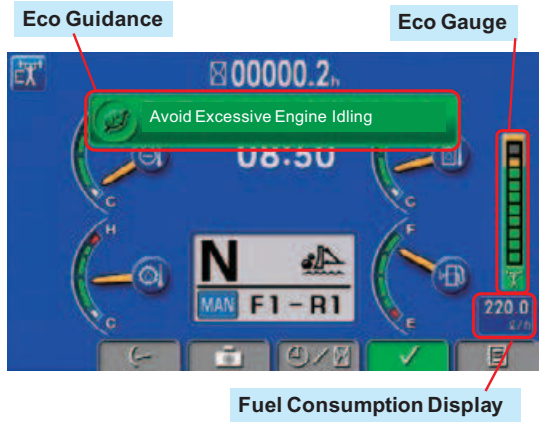
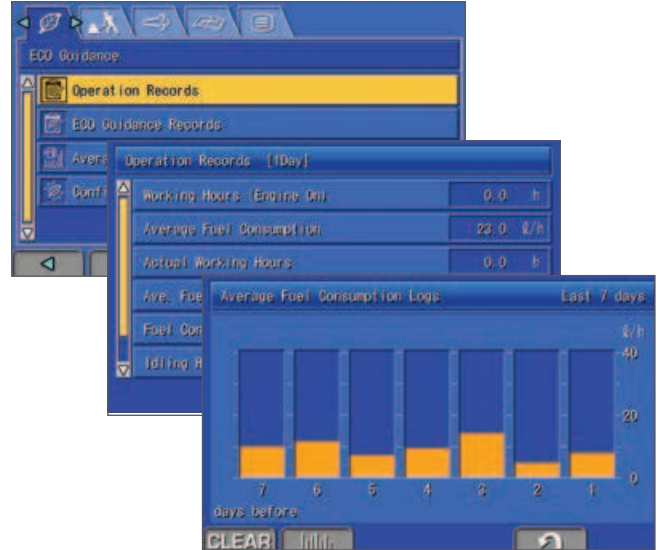

Rear View Monitoring System

On the large LCD color monitor, the operator can view, through one camera, areas directly behind the machine. This camera can be synchronized with reverse operation.



COMPLETE OPERATOR CONTROL

Human-Machine Interface

Palm Command Control System (PCCS) Travel Joystick

Palm command travel joystick provides the operator with a relaxed posture and superb fine control. Transmission shifting is simplified with thumb push buttons.

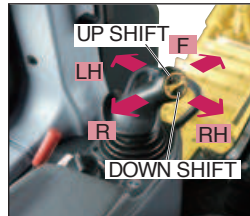

Palm Command Proportional Pressure Control (PPC) Blade Control Joystick

Blade control joystick uses the PPC valve and joystick, similar to the travel control joystick. PPC control combined with the highly reliable Komatsu hydraulic system enables superb fine control.



Power Train Electronic Control System

Automatic/Manual Shift Selectable Mode

Automatic or manual shift modes can be selected with ease to suit the work at hand by simply pressing the switch on the multi-monitor (selection at neutral).

Automatic shift mode

Select for all general dozing. When a load is applied, the transmission automatically shifts down, and when the load is off, it automatically shifts up to a set maximum gear speed. This mode economizes both fuel and production further when the torque converter lockup mechanism is actuated according to load, providing a one-to-one drive.



Manual shift mode

Select for dozing and ripping rough ground. When loaded, the transmission automatically shifts down, but does not shift up when the load is off.

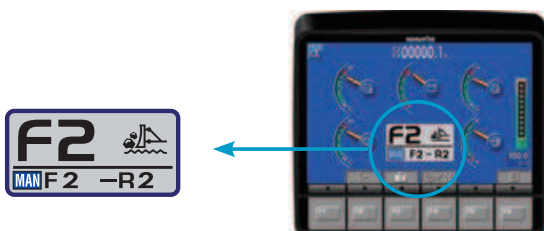

Shift Pattern Preset Function

When the shift pattern is set to either <F1-R2>, <F2-R1>, <F2-R2>, <F2-R3L> or <F3L-R3L> in the automatic mode, the transmission automatically shifts to the preset gear when the travel control joystick is set to Forward or Reverse position, reducing work cycle time and operator effort. Shift patterns <F2-R3L> and <F3L-R3L> are newly added for high-speed leveling operation.

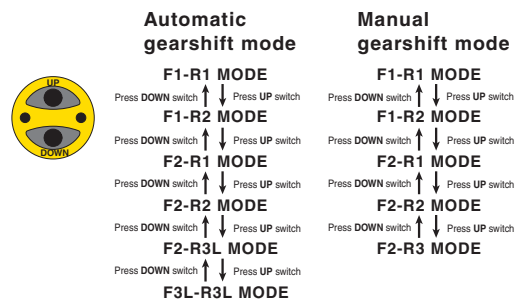

Electronic Controlled Modulation Valve (ECMV) Transmission

A controller automatically adjusts each clutch engagement depending on travel conditions, providing smooth shockless clutch engagement, improved component life and operator ride comfort.

Hydrostatic Steering System (HSS) – Smooth, Powerful Turning

The engine power is transmitted to both tracks without power interruption on the inside track for smooth, powerful turns. Counter-rotation is available in neutral for minimum turning radius, enhancing maneuverability.



Photos may include optional equipment

Newly Integrated ROPS Cab

A newly designed cab; wide, deep and tall, is integrated with the ROPS. High rigidity and superb sealing performance greatly reduce noise and vibration for the operator and minimize dust entering the cab. The standard air-ride seat positions the operator comfortably. The tall and narrow battery box and tanks plus larger glass area also improve visibility of the blade, sides, and rear of the machine. Cab meets OSHA/MSHA ROPS and FOPS Level 2 standards.

Large Multi-Lingual LCD Color Monitor

A large user-friendly color monitor enables accurate and smooth work. Excellent screen visibility is achieved by the use of a TFT liquid crystal display that can easily be read at various angles and lighting conditions. Simple and easy to operate switches. Function keys facilitate multi-function operations. Data can be displayed in 25 languages for local customization.



Comfortable Ride with Cab Damper Mounting

The D155's cab mount uses a cab damper which provides excellent shock and vibration absorption capacity. The long stroke cab damper mounts soften shocks and vibration while traveling over adverse conditions, which conventional rubber mounting systems are unable to match. The cab damper spring isolates the cab from the machine body, suppressing vibration and providing a quiet, comfortable operating environment.

New Air Suspension Seat

A new higher capacity low-back heated seat with headrest and swivel is now standard.



Auxiliary Input Jack

By connecting an auxiliary device to this plug input, the operator can hear sound through the speakers installed in the cab.



MAINTENANCE AND RELIABILITY FEATURES

Multi-monitor with Troubleshooting Function to Help Prevent Critical Machine Trouble

Various meters, gauges and warning functions are centrally arranged on the multi-monitor. The monitor simplifies start-up inspection and promptly warns the operator with a lamp and buzzer if any abnormalities should occur. In addition, countermeasures are indicated in 4 levels to help prevent major problems. Replacement times for oil and filters are also indicated.

Gull-wing Engine Side Covers

The engine side covers are gull-wing type with a gas spring, and the opening angle of the cover is further increased to facilitate engine maintenance and filter replacement.

Maintenance Function

When the machine reaches the replacement interval for oil and filters, the monitor panel will display lights to inform the operator.

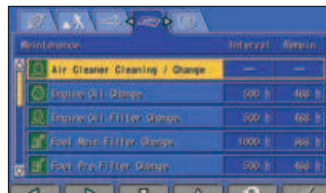

K-Bogie Undercarriage

K-Bogie track rollers having a large oscillation travel always follow the track link even on uneven ground. This feature keeps the correct alignment between the rollers and links to contribute to long undercarriage component life.

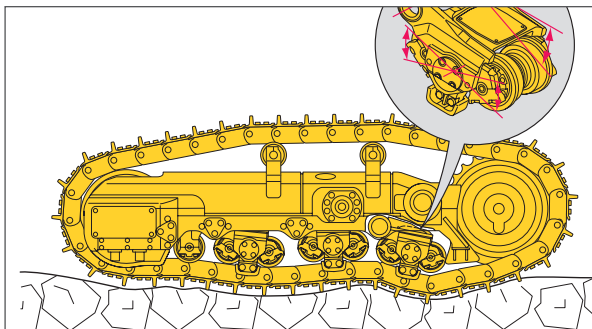

Oil Pressure Check Ports

Pressure check ports for power train components are centralized to promote quick and simple diagnosis.

Wide Core Cooling System

In addition to improved engine compartment sealing, a new wide core cooling system is standard. Radiator, oil cooler and charge air cooler use large square-wave fins spaced at 6 fins per inch. This allows more material to pass through, which helps self-cleaning and reduces maintenance.

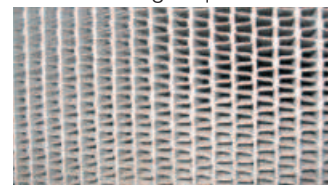

Battery Disconnect Switch

A standard battery disconnect switch allows a technician to disconnect the power supply before servicing the machine.



Secondary Engine Shutdown Switch

A new secondary switch has been added, at the side of the front console, to shut down the engine.





Komatsu CARE – Complimentary Scheduled Maintenance

- PM services for the earlier of 3 years / 2000 hours
- Plus two complimentary KDPF exchanges within the first 5 years (excludes labor)
- Performed by factory certified technicians
- Komatsu Genuine parts and fluids
- Significantly lowers your cost of ownership while maintaining high uptime and reliability
- Increases resale value and provides detailed maintenance records
- Extended PM services can be purchased beyond the complimentary period to provide additional peace of mind and maximize uptime



Komatsu CARE – Extended Coverage

- Extended Coverage can provide peace of mind by protecting customers from unplanned expenses that effect cash flow
- Purchasing extended coverage locks-in the cost of covered parts and labor for the coverage period and helps turn these into fixed costs



Komatsu Parts Support

- 24/7/365 to fulfill your parts needs
- 9 parts Distribution Centers strategically located across the U.S. and Canada
- Distributor network of more than 300 locations across U.S. and Canada to serve you
- Online part ordering through Komatsu eParts
- Remanufactured components with same-as-new warranties at a significant cost reduction



Komatsu Oil and Wear Analysis (KOWA)

- KOWA detects fuel dilution, coolant leaks, and measures wear metals
- Proactively maintain your equipment
- Maximize availability and performance
- Can identify potential problems before they lead to major repairs
- Reduce life cycle cost by extending component life

KOMTRAX EQUIPMENT MONITORING

GET THE WHOLE STORY WITH
KOMTRAX[®]

✓ WHAT

- KOMTRAX is Komatsu's remote equipment monitoring and management system
- KOMTRAX **continuously monitors and records** machine health and operational data
- Information such as fuel consumption, utilization, and a detailed history **aids in making repair or replacement decisions**

✓ WHEN

- Know when your machines are **running or idling** and make decisions that will improve your fleet utilization
- Detailed movement records ensure you know when and where your equipment is moved
- Up to date records allow you to **know when maintenance was done** and help you plan for future maintenance needs

✓ WHERE

- KOMTRAX data **can be accessed virtually anywhere** through your computer, the web or your smart phone
- Automatic alerts keep fleet managers up to date on the latest machine notifications

✓ WHY

- Knowledge is power - **make informed decisions** to manage your fleet better
- Knowing your idle time and fuel consumption will help maximize your machine efficiency
- **Take control of your equipment** - any time, anywhere

✓ WHO

- KOMTRAX is **standard** equipment on all Komatsu construction products



Monthly Operational Analysis



Fuel Consumption Reports

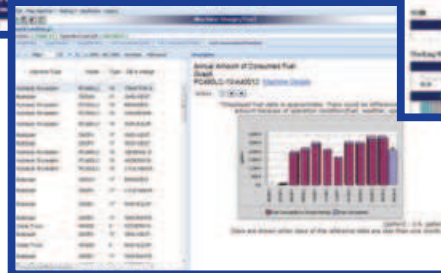

KOMTRAX[®]

For construction and compact equipment.

KOMTRAX Plus

For production and mining class machines.

SPECIFICATIONS

D155AX-7



ENGINE

Model.....Komatsu SAA6D140E-6*
 Type..... 4-cycle, water-cooled, direct injection
 Aspiration.....Komatsu variable geometry turbocharged, air-to-air aftercooled, cooled EGR
 Number of cylinders..... 6
 Bore x stroke..... 140 mm x 165 mm **5.51" x 6.50"**
 Piston displacement..... 15.24 ltr **930 in³**
 Governor.....All-speed and mid-range, electronic
 Horsepower
 SAE J1995..... Gross 268 kW **360 HP**
 ISO 9249 / SAE J1349..... Net 264 kW **354 HP**
 Rated rpm..... 1900 rpm
 Fan drive type.....Hydraulic
 Lubrication system
 Method..... Gear pump, force lubrication
 Filter..... Full-flow
 *EPA Tier 4 Interim and EU stage 3B emissions certified



TORQFLOW TRANSMISSION

Komatsu's automatic TORQFLOW transmission consists of a water-cooled, 3-element, 1-stage, 2-phase, torque converter with lockup clutch, and a planetary gear, multiple-disc clutch transmission which is hydraulically actuated and force-lubricated for optimum heat dissipation. Equipped with gearshift lock lever and neutral start switch.

Travel speed	Forward	Reverse
1st	3.8 km/h 2.4 mph	4.6 km/h 2.9 mph
2nd	5.6 km/h 3.5 mph	6.8 km/h 4.2 mph
3rd L	7.5 km/h 4.7 mph	9.2 km/h 5.7 mph
3rd	11.6 km/h 7.2 mph	14.0 km/h 8.7 mph

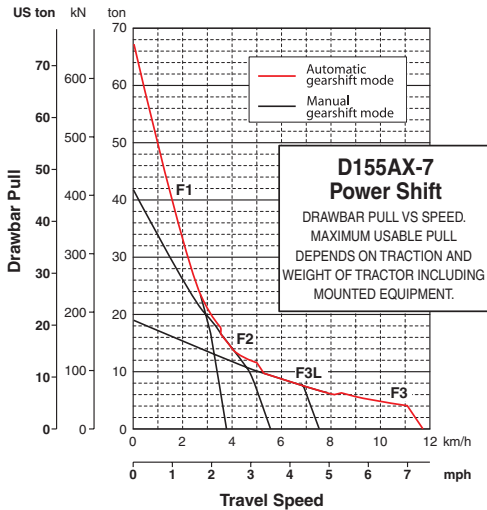

FINAL DRIVES

Double-reduction, spur and planetary final drives increase tractive effort. Segmented sprockets are bolt-on for easy in-the-field replacement.



STEERING SYSTEM

Palm Command Control System (PCCS) lever controls for all directional movements. Pushing the PCCS lever forward results in forward machine travel, while pulling it rearward reverses the machine. Simply tilt the PCCS lever to the left to make a left turn. Tilt it to the right for a right turn.

Hydrostatic Steering System (HSS) is powered by steering planetary units and an independent hydraulic pump and motor. Counter-rotation turns are also available. Wet, multiple-disc, pedal-controlled service brakes are spring-actuated and hydraulically released. Gearshift lock lever also applies parking brakes.

Minimum turning radius..... 2.14 m **7'0"**



UNDERCARRIAGE

Suspension.....Oscillation-type with equalizer bar and forward mounted pivot shafts
 Track roller frame.....Monocoque, high-tensile-strength steel construction
 Rollers and idlers..... Lubricated
 K-Bogie undercarriage
 Lubricated track rollers are resiliently mounted on the track frame with a bogie suspension system whose oscillating motion is cushioned by rubber pads.

Track shoes
 Lubricated tracks. Unique dust seals for preventing entry of foreign abrasives into pin-to-bushing clearance for extended service. Track tension easily adjusted with grease gun.

Number of shoes (each side)..... 42
 Grouser height..... 80 mm **3.1"**
 Shoe width (standard/maximum)..... 610 mm **24"/710 mm 28"**
 Ground contact area.....39955 cm² **6,193 in²**
 Ground pressure (tractor only) ... 82.4 kPa 0.84 kg/cm² **11.9 psi**
 Number of track rollers (each side)..... 7
 Number of carrier rollers (each side)..... 2



SERVICE REFILL CAPACITIES

Fuel tank..... 625 ltr **165 U.S. gal**
 Coolant..... 103.5 ltr **27.3 U.S. gal**
 Engine oil..... 37 ltr **9.8 U.S. gal**
 Damper..... 1.5 ltr **0.4 U.S. gal**
 Hydraulic oil..... 91.5 ltr **24.2 U.S. gal**
 Transmission, bevel gear, and steering system..... 90 ltr **23.8 U.S. gal**
 Final drive (each side).....31 ltr **8.2 U.S. gal**



OPERATING WEIGHT

Tractor weight..... 31700 kg **69,887 lb**
 Including rated capacity of lubricant, coolant, full fuel tank, operator and standard equipment.
 Operating weight..... 39500 kg **87,100 lb**
 Including strengthened SIGMADOZER®, giant ripper, ROPS cab, operator, standard equipment, rated capacity of lubricant, coolant, and full fuel tank.
 Ground pressure..... 106 kPa 1.08 kg/cm² **15.4 psi**



DIMENSIONS

A	4060 mm	13'4"	F	8310 mm	27'2"
B	2140 mm	7'0"	G	2745 mm	9'0"
C	3385 mm	11'1"	H	1240 mm	4'1"
D	1880 mm	6'2"	I	950 mm	3'1"
E	3275 mm	10'9"	J	3395 mm	11'2"

Cab Dimensions:

Length.....	1735 mm	5'8"
Width.....	1755 mm	5'9"
Height from floor.....	1635 mm	5'4"

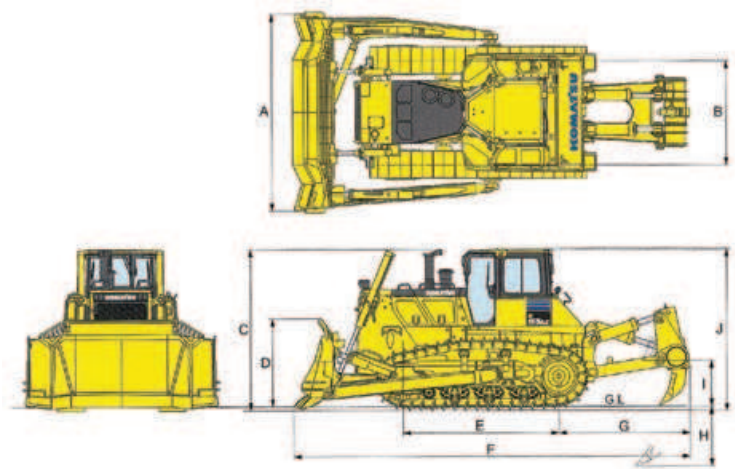

HYDRAULIC SYSTEM

Closed-center load sensing system (CLSS) designed for precise and responsive control, and for efficient simultaneous operation.

Hydraulic control unit:

All spool control valves externally mounted beside the hydraulic tank. Variable piston pump with capacity (discharge flow) of 325 ltr/min **85.9 U.S. gal/min** for steering and 180 ltr/min **47.6 U.S. gal/min** for implemented at rated engine rpm.

Relief valve setting:

..... for implement	27.5 MPa	280 kg/cm ²	3,980 psi
..... for steering	38.2 MPa	390 kg/cm ²	5,550 psi

Control valves:

Spool control valve for SIGMADOZER®, Semi-U dozer and Full-U dozer.

Positions: Blade lift	Raise, hold, lower, and float
Blade tilt	Right, hold, and left

Additional control valve required for variable digging angle multi-shank ripper and giant ripper.

Positions: Ripper lift.....	Raise, hold, and lower
Ripper tilt.....	Increase, hold, and decrease

Hydraulic cylinders.....Double-acting, piston

	Number of cylinders	Bore
Blade lift	2	110 mm 4.33"
Blade tilt (Dual tilt)	2	160 mm 6.30"
Blade tilt (Single tilt)	1	160 mm 6.30"
Ripper lift	1	180 mm 7.09"
Ripper tilt	1	200 mm 7.87"

Hydraulic oil capacity (refill):

SIGMADOZER.....	85 ltr	22.5 U.S. gal
Semi-U dozer.....	85 ltr	22.5 U.S. gal
Full-U dozer.....	85 ltr	22.5 U.S. gal

Ripper equipment (additional volume):

Multi-shank ripper	37 ltr	9.8 U.S. gal
Giant ripper	37 ltr	9.8 U.S. gal



DOZER EQUIPMENT

Use of high-tensile-strength steel in moldboard for strengthened blade construction.

Blade tilt hose piping is mounted inside the dozer push arm to protect from damage.

	Overall Length With Dozer	Blade Capacity	Blade Length x Height	Max. Lift Above Ground	Max. Drop Below Ground	Max. Tilt Adjustment	Additional Weight
Strengthened SIGMADOZER®*	6205 mm 20'4"	9.4 m ³ 12.3 yd³	4060 mm x 1880 mm 13'4" x 6'2"	1340 mm 4'5"	730 mm 2'5"	920 mm 3'0"	5360 kg 11,820 lb
Full-U Dozer*	6695 mm 22'0"	11.9 m ³ 15.6 yd³	4260 mm x 1790 mm 14'0" x 5'10"	1345 mm 4'5"	630 mm 2'1"	970 mm 3'2"	5630 kg 12,420 lb
Semi-U Dozer*	6270 mm 20'7"	9.4 m ³ 12.3 yd³	4130 mm x 1790 mm 13'7" x 5'10"	1345 mm 4'5"	630 mm 2'1"	953 mm 3'0"	4960 kg 10,936 lb

* Dual tilt dozer



STANDARD EQUIPMENT FOR BASE MACHINE*

- Air cleaner, double element with dust indicator
- Alternator, 90 ampere/24V
- Backup alarm
- Batteries, 200 Ah/2 x 12V
- Battery disconnect switch
- Blade lift cylinders
- Color monitor, LCD
- Decelerator pedal
- Engine hood
- Engine intake centrifugal precleaner
- Engine, gull-wing side covers
- Engine shutdown secondary switch
- Exhaust pipe with raincap
- Fast fuel provision
- Fenders
- Front pull hook
- High mount foot rests
- Horn, warning
- Hydraulic driven radiator cooling fan with manual reverse clean mode
- Hydraulics for dual tilt and pitch dozer
- Hydraulics for ripper VGR/MSR
- KOMTRAX® Level 4
- K-bogie undercarriage
- Komatsu Diesel Particulate Filter (KDPF)
- Komatsu Variable Geometry Turbocharger (KVGTT)
- Locks, filler caps and covers
- Oil pressure check ports for power train
- PM service connector
- Radiator mask, heavy-duty, hinged, perforated
- Radiator reserve tank
- Rear cover
- ROPS cab (700 kg, **1,545 lb**)**
 - Air conditioner
 - Pressurized
 - Cab accessories
 - 12V power supply (2 ports)
 - Cup holder
 - Rearview mirror
 - Rear view monitoring (1 camera)
 - AM/FM Radio w/remote AUX plug (3.5 mm)
 - Work lights
 - 2 front, hood mounted
 - 2 front, cab mounted
 - 1 rear, left fender mounted
 - 2 rear, cab mounted
 - 1 rear, for ripper
 - 1 rear, for ripper point
- Seat, air suspension, fabric, heated, low back, rotates 15° to right, headrest
- Seat belt, 76 mm **3"**, retractable
- Seat belt indicator
- Sealed electrical connectors
- Starting motor, 11.0 kW/24V
- Steering system: Hydrostatic Steering System (HSS)
- Topcon enhanced provision, SN 90153 and up. Excluding landfill machine. See finishing kit. Under optional equipment.
- Torque converter with auto lock-up
- Track roller guards, end sections
- Track shoe assembly
 - Sealed and lubricated
 - 610 mm **24"** extreme service shoes
- Transmission with auto/manual shift modes
- Underguards, heavy duty
 - Hinged belly pan
 - Transmission
- Water separator, fuel
- Wide core cooling package, 6 fins per inch spacing

* Dozer assembly and rear mounted equipment are not included in base machine standard equipment

** Cab meets OSHA/MSHA ROPS and FOPS Level 2 standards



OPTIONAL EQUIPMENT

■ Shoes

Shoes (optional)	Additional weight	Ground contact area
660 mm 26" extreme service shoes	+940 kg +2,070 lb	43230 cm ² 6,700 in²
710 mm 28" single-grouser shoes	+620 kg +1,370 lb	46505 cm ² 7,208 in²

■ Variable multi-shank ripper

- Additional weight (including hydraulic control unit): 3760 kg **8,290 lb**
- Beam length: 2320 mm **7'7"**
- Hydraulically-controlled parallelogram-type ripper with three shanks. Digging angle infinitely adjustable. Standard digging angle*: 49°
- Maximum digging depth: 900 mm **2'11"**
- Maximum lift above ground: 950 mm **3'1"**

■ Variable giant ripper

- Additional weight (including hydraulic control unit): 2440 kg **5,380 lb**
- Beam length: 1400 mm **4'7"**
- Hydraulically-controlled parallelogram-type ripper with one shank. Digging angle infinitely adjustable. Standard digging angle*: 49°
- Maximum digging depth: 1240 mm **4'1"**
- Maximum lift above ground: 950 mm **3'1"**

* Measured with ripper point on ground and shank vertical.

■ Other

- Winch, Allied Systems Model H12E
- Guarding - rear screen with hinged rear door
- Guarding front sweeps
- Guarding cab side window screens
- Counterweight 7-plate with rigid drawbar, 2098 kg **4,624 lb**
- HD Counterweight 9-plate with rigid drawbar, 3588 kg **7,910 lb**
- Counterweight for landfill / woodchip with rigid drawbar, 4115 kg **9,072 lb**
- Landfill Package
- Woodchip Package
- Sigma push group (bladeless) for Allied blade
- Topcon plug & play finishing kit (bolt-on brackets) to create plug & play dozer, SN 90153 & up

■ Dozer Equipment

- SIGMADOZER®
- Full-U
- Semi-U
- Woodchip 36 cu-yd

D155AX-7

