

KOMATSU

HM
400



Articulated Dump Truck

HM400-3

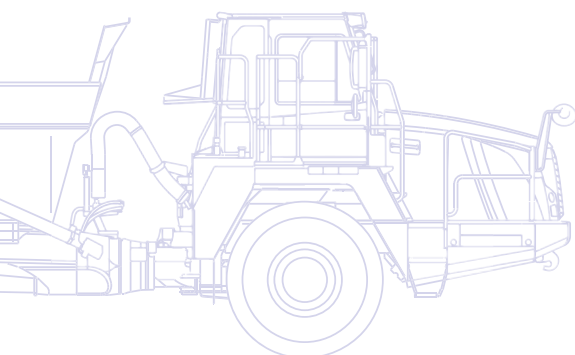

ENGINE POWER
353 kW / 473 HP @ 2.000 rpm

MAX. PAYLOAD
40,0 ton

BODY CAPACITY, HEAPED
24,0 m³

Courtesy of Machine.Market

Walk-Around

The latest Komatsu technology and components combine to put the HM400-3 articulated dump truck in a class of its own. The EU Stage IIIB/EPA Tier 4 interim engine platform provides it with increased horsepower and lower fuel consumption and emissions. An advanced and exclusive Komatsu Traction Control System optimizes overall performance on any ground condition. With a new look for its robust exterior, and state of the art solutions for its suspension and retarder systems, the HM400-3 is built to last.

First-class operator comfort

- Front and rear hydro-pneumatic suspension
- Multi-purpose colour monitor with Eco-guidance function
- Quiet and spacious work environment
- Power window
- Air suspension seat with headrest



Easy maintenance

- Electrically tilting cab
- Centralized grease points
- Maintenance-free oscillating hitch
- Maintenance-free wet brakes
- Easy and safe access to the engine

HM400-3

High productivity and efficiency

- Exclusive Komatsu Traction Control System (KTCS)
- Increased body capacity (40,0 m³)
- Fuel efficient EU Stage IIIB engine
- High capacity wet multiple disc brakes
- Komatsu Advanced Transmission

ENGINE POWER
353 kW / 473 HP @ 2.000 rpm

MAX. PAYLOAD
40,0 ton

BODY CAPACITY, HEAPED
24,0 m³



Tough and reliable

- Market leading Komatsu design
- Wet multiple-disc brakes and retarder
- K-ATOMiCS transmission
- Komatsu-built power train
- High-strength body

Highest safety standards

- Secure platform access to cab and maintenance areas
- Excellent all-round visibility
- Rear view camera system
- Highly responsive retarder
- Safe front access

KOMTRAX

Komatsu Wireless
Monitoring System

High Productivity and Efficiency

New Komatsu engine technology

The powerful and fuel-efficient Komatsu SAA6D140E-6 engine in the HM400 delivers 353 kW/473 HP at 2.000 rpm and is EU Stage IIIB/ EPA Tier 4 interim certified. To maximise power, fuel efficiency and emission compliance, it is turbo charged and features direct fuel injection, air-to-air after cooling and cooled EGR.

Komatsu Traction Control System (KTCS)

For its world renowned RDTs Komatsu developed various wheel slip control systems that were refined and combined with new technologies to produce the advanced traction control system that equips all HM400-3 machines. KTCS automatically provides optimum traction on any ground condition. If tyre slippage is detected by speed

sensors located on four wheels, automatic application of the inter-axle differential lock occurs. If tyre slippage continues, the intelligent brakes systems automatically control the slipping wheel and regain traction on the opposite side. This improves productivity but also tyre durability.

Komatsu Diesel Particulate Filter (KDPF)

Komatsu's high efficiency DPf captures more than 90% of particulate matter. It includes a special oxidation catalyst with fuel injection system that can incinerate trapped particulates by either active or passive regeneration with no need to interrupt machine operations.

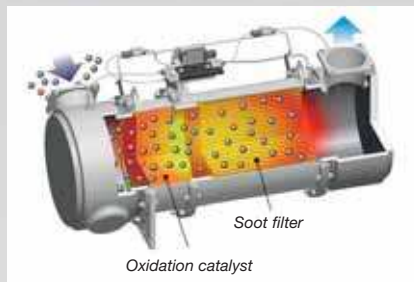

Exhaust Gas Recirculation (EGR)

Cooled EGR is a technology well-proven in current Komatsu engines. The increased capacity of the EGR cooler now ensures very low NOx emissions and a better engine performance.

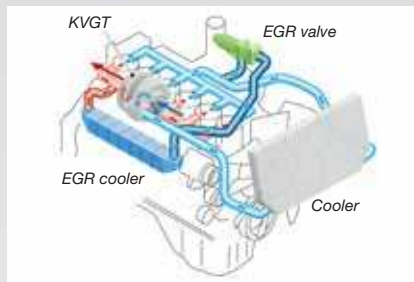

Komatsu Variable Geometry Turbo (KVG T)

The KVG T provides optimal air flow to the engine combustion chamber under all speed and load conditions. Exhaust gas is cleaner, fuel economy is improved while machine power and performance are maintained.

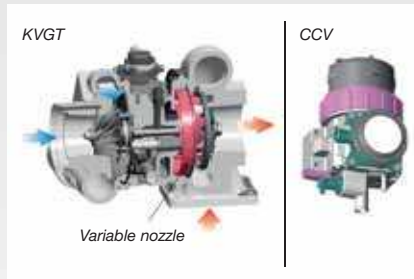

Komatsu Closed Crankcase Ventilation (KCCV)

Crankcase emissions (blow-by gas) are passed through a CCV filter. The oil mist trapped in the filter is returned back to the crankcase while the filtered gas is returned to the air intake.

High-Pressure Common Rail (HPCR)

To achieve complete fuel burn and lower exhaust emissions, the heavy duty High-Pressure Common Rail fuel injection system is computer controlled to deliver a precise quantity of pressurised fuel into the redesigned engine combustion chamber by multiple injections.

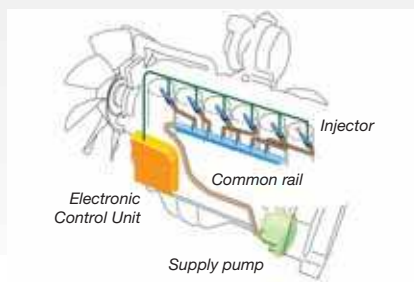



Large capacity body

With an increased payload of 40 tonnes, the HM400-3's body capacity combined with a loading height of only 3.165 mm enables easy loading, lowers the centre of gravity and maintains a high ground clearance.



First-Class Operator Comfort

Unique hydro-pneumatic suspension

On both, the front and rear axles, Komatsu's unique trailing arm hydro-pneumatic suspension gives the HM400-3 a smooth ride with reduced pitching and excellent driving comfort. Less shocks to the operator and to the machine components - and less spilled material - also result in increased durability, comfort, and productivity.

Large TFT colour multi monitor

A large user-friendly colour monitor enables safe, accurate and smooth work. It provides on-hand data to continuously improve productivity and fuel consumption. Multilingual and with all essential information available at a glance, it features simple and easy to operate switches and multifunction keys that provide the operator with fingertip access to a wide range of functions and operating information.

Wide and comfortable cab

The wide cab with user-friendly controls provides a spacious and comfortable working environment. A fully adjustable air-suspension seat dampens vibrations, holds the operator safe, and reduces the fatigue of long shifts. Plenty of room is left for an extra full-size trainer's seat. Large front and electric side windows ensure superior visibility and increased operator confidence, while an electric heated rear window facilitates defrosting and speeds the start-up of operations.

Low noise levels

To reduce the noise levels, the cab is mounted on viscous dampeners. Further noise reduction is achieved by the integrated cab floor: it makes the cab air-tight and seals off the engine compartment. A low-noise and sound-insulated muffler helps to bring the sound levels way down to 72 dB(A).





Tough and Reliable

Market leading Komatsu design

The HM400-3 is made from Komatsu manufactured components that successfully prove their durability day after day. Top-selling technology used for previous generations of Komatsu trucks sets the mould for all Komatsu ADTs. The entire power train is Komatsu designed and the engine, transmission and axles are perfectly matched for unsurpassed productivity and durability.

K-ATOMiCS transmission

K-ATOMiCS, Komatsu's exclusive electronically controlled transmission is perfectly tuned for the HM400-3. The "total control system" manages both the engine and transmission by monitoring the vehicle's condition. This Komatsu designed technology guarantees smooth shifting and maximises transmission life.

Wet multiple-disc brakes and retarder

Wet multiple-disc brakes with proven performance in larger articulated and rigid trucks are tailored for use in the HM400-3. The large-capacity, continuously cooled, wet-multiple disc brakes also function as a highly responsive retarder that gives the operator greater confidence at higher speeds when travelling downhill. (Retarder absorbing capacity, continuous descent: 510 kW 683 HP; in F4)

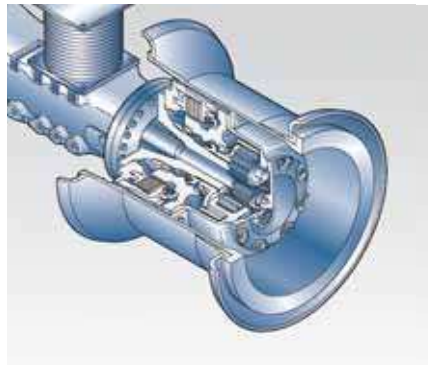

Hydraulically controlled wet multi-disc brakes and retarder

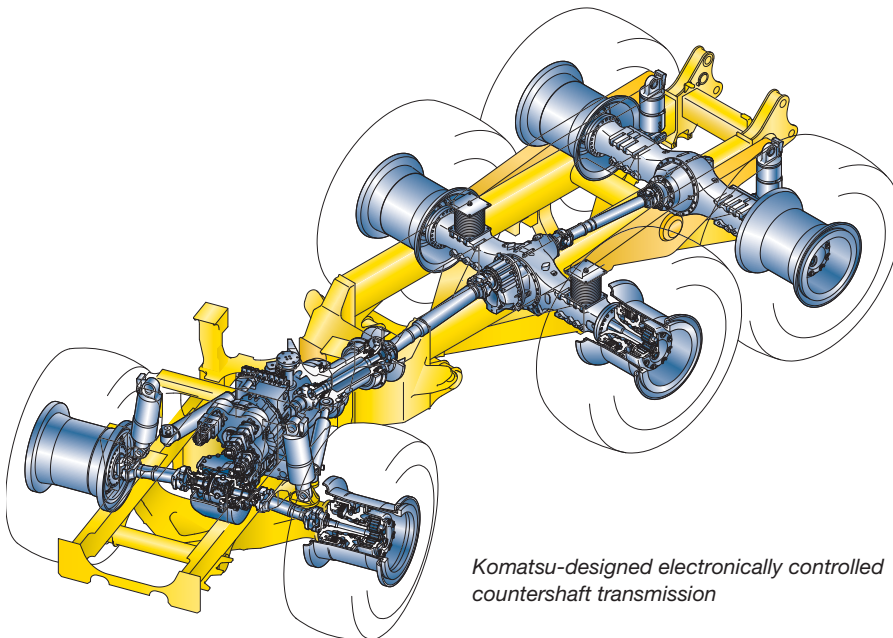

Komatsu-designed electronically controlled countershaft transmission





Easy Maintenance

Lowest brake maintenance cost

No other manufacturer offers wet disc brakes on all its ADTs, and the Komatsu HM400-3 is no exception. No matter how abrasive the application, there is no need to worry about early replacement of the brake disc packs of its forced oil-cooled wet disc brakes. Embedded in an oil bath and sealed off from the environment, brakes on the HM400-3 have an exceptionally long overhaul period minimizing your maintenance cost.



Remote greasing



Ground level access



Maintenance monitor

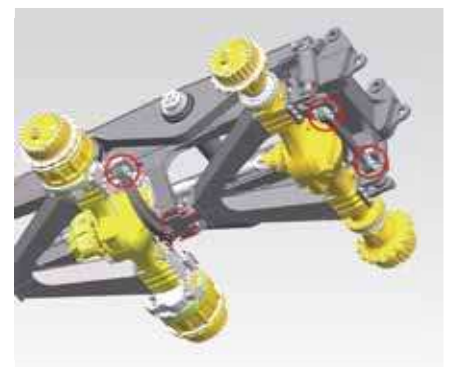

Rubber bushings and hydro-pneumatic suspension are standard

Hinge connection

With 710 mm free space, the hinge connection on the HM400-3 stays out of the mud and its robust maintenance-free build gives it a longer life time.

Tilting cab

The cab can be tilted rearward 36 degrees to provide easy maintenance and service to the engine and transmission.





Highest Safety Standards

Safer with KTCS

By operating only the accelerator, Komatsu's unique traction control system (KTCS) allows full-time all wheel drive, along with safe and easy turning on soft ground and slippery roads. The driver requires no extra driving or operational skill.

Supplementary steering and secondary brakes

Supplementary steering and secondary brakes are standard features. They help to guarantee operator safety in emergency situations.

Steering

ISO 5010-1992, SAE J1511

Brakes

ISO 3450-1996, SAE J1473

Excellent all-round visibility

To keep the working area under control, a laminated-glass windshield, wide side windows, a standard rear-view camera and monitor, 3 additional under-view mirrors and 4 rear-view mirrors minimise blind spots.

Built-in ROPS/FOPS

These structures conform to ISO 3471 and SAE J1040-1988c standards.

Safe access

Operators can enter the machine easily and safely with a secure access from the platform to the cab. The access steps are located on the front of the machine, away from the potentially hazardous articulation.

Rear frame inclination sensor

To avoid personal and machine damage, this system warns the operator if there is a risk of body tip over.



Rear view camera system



Standard guards

- Protective fence around engine hood
- Protective grille for rear window
- Engine underguard
- Heavy-duty transmission underguard
- Propeller shaft guards
- Exhaust thermal guard
- Fire prevention covers



Komatsu Wireless Monitoring System

The easy way to higher productivity

KOMTRAX™ is the latest in wireless monitoring technology. It delivers insightful and cost saving information about your fleet and equipment and offers you a wealth of information to facilitate peak machine performance. By creating a tightly integrated web of support it allows pro active and preventive maintenance and helps you to efficiently run a business.

Knowledge

You get quick answers to basic and critical questions about your machines - what they're doing, when they did it, where they're located, how they can be used more efficiently, and when they need to be serviced. Performance data is relayed by satellite from your machine to your computer and to your local Komatsu distributor - who's readily available for expert analysis and feedback.

Convenience

KOMTRAX™ helps to conveniently manage your fleet on the web, wherever you are. Data is analysed and packaged specifically for easy and intuitive viewing in maps, lists, graphs and charts. You can anticipate the type of service and parts your machines could require, or troubleshoot problems before Komatsu technicians arrive on site.





Power

The detailed information that KOMTRAX™ puts at your fingertips 24 hours a day, 7 days a week gives you the power to make better daily and long-term strategic decisions. You can anticipate problems, customize maintenance schedules, minimize downtime and keep your machines where they belong – working on the job site.

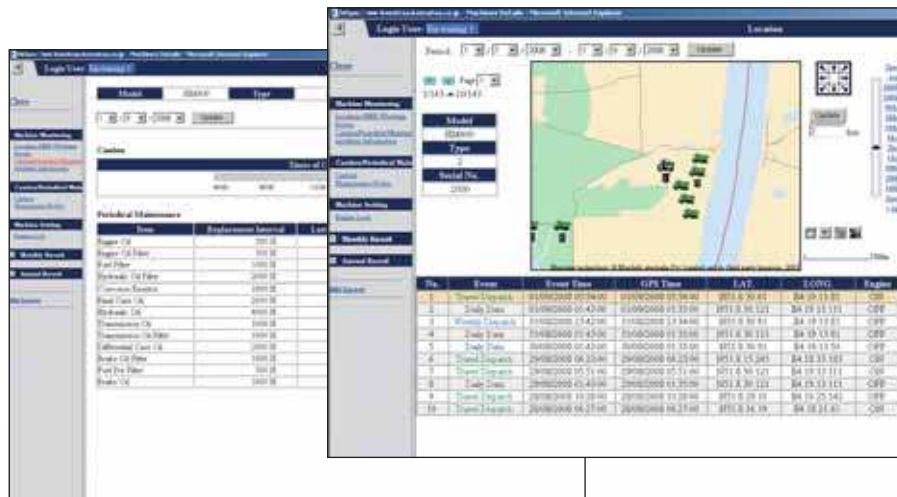

Through the web application, a variety of search parameters are available to quickly find information about specific machines based on key factors such as utilization rates, age, various notification messages, and more.

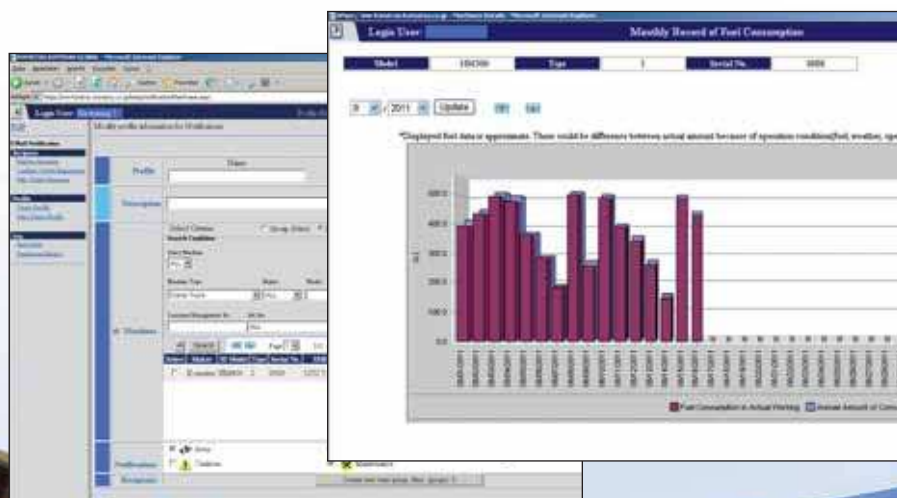

A simple chart shows the machine's fuel consumption and helps you to calculate total costs for a job site and conveniently schedule fuel deliveries.

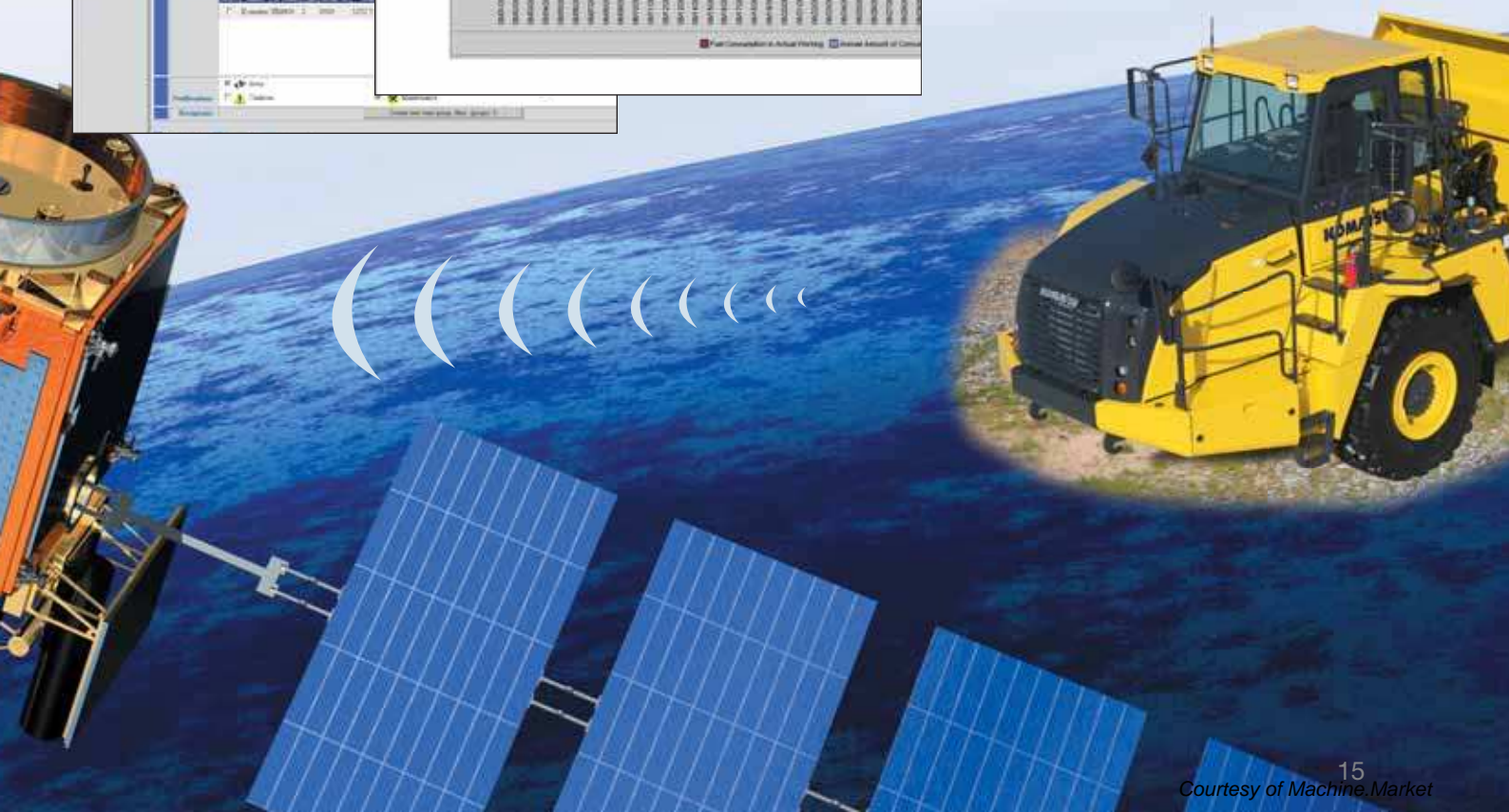

Specifications

ENGINE

Model	Komatsu SAA6D140E-6 Common rail direct injection, water-cooled, emissionised, turbocharged, after-cooled diesel
Engine power	
at rated engine speed	2.000 rpm
ISO 14396	353 kW / 473 HP
ISO 9249 (net engine power)	350 kW / 469 HP
No. of cylinders	6
Bore × stroke	140 × 165 mm
Displacement	15,24 ltr
Max. torque	2.263 Nm (231 kgf-m)
Governor	Electronically controlled
Lubricating system	Gear pump, force lubrication
Filter	Full-flow filter
Air-filter type	Dry type with double elements and precleaner (cyclonpack type), plus dust indicator

TRANSMISSION

Torque converter	3-elements, 1-stage, 2-phase
Transmission	Full-automatic, counter-shaft type
Speed range	6 speeds forward and 2 reverse
Lock-up clutch	Wet, single-disc clutch
Forward	Torque converter drive in 1st gear, direct drive in 1st lock-up and all higher gears
Reverse	Torque converter drive and direct drive in all gears
Shift control	Electronic shift control with automatic clutch modulation in all gears
Max. travel speed	55,9 km/h

STEERING SYSTEM

Type	Articulated type, fully hydraulic power steering with two double-acting cylinders
Supplementary steering	Automatically actuated, electrically powered
Minimum turning radius, wall to wall	8,80 m
Articulation angle	45° each direction

SUSPENSION

Front	Hydro-pneumatic suspension
Rear	Combined hydro-pneumatic and rubber suspension system

TYRES

Standard tyres	29.5 R25
----------------------	----------

CAB

Complies ISO 3471 ROPS (Roll-Over Protective Structure) ISO 3449 FOPS (Falling Object Protection Structure) standards.

AXLES

Full time all wheel drive with Komatsu Traction Control System.	
Final drive type	Planetary gear
Ratios:	
Differential	3,272
Planetary	4,941

BRAKES

Service brakes	Independent front and center wheel brakes, full-hydraulic control, oil-cooled, multiple-disc type
Parking brake	Spring applied, calliper disc type
Retarder	Front and centre axle brakes act as retarder

MAIN FRAME

Type	Articulated type, box-sectioned construction on front and rear. Connected by strong torque tubes.
------------	---

SERVICE REFILL CAPACITIES

Fuel tank	518 ltr
Engine oil	50 ltr
Torque converter, transmission and retarder cooling	125 ltr
Differentials (total)	108 ltr
Final drives (total)	32 ltr
Hydraulic system	167 ltr
Suspension (total)	21,4 ltr

HYDRAULIC SYSTEM

Hoist cylinder	2 single stage cylinders
Relief pressure	27 MPa (275 kg/cm ²)
Hoist time (at 1.800 rpm)	12 sec

ENVIRONMENT

Engine emissions	Fully complies with EU Stage IIIB and EPA Tier 4 interim exhaust emission regulations
Noise levels	
LwA external	110 dB(A) (2000/14/EC Stage II)
LpA operator ear	72 dB(A) (ISO 6396 dynamic test)
Vibration levels (EN 12096:1997)*	
Hand/arm	≤ 2,5 m/s ² (uncertainty K = 1,31 m/s ²)
Body	≤ 0,5 m/s ² (uncertainty K = 0,42 m/s ²)

* for the purpose of risk assessment under directive 2002/44/EC, please refer to ISO/TR 25398:2006.

WEIGHT (APPROX.)

Empty weight.....	33.660 kg
Gross vehicle weight	73.740 kg
Weight distribution:	
Empty:	
Front axle	56,4%
Center axle.....	22,5%
Rear axle.....	21,1%
Loaded:	
Front axle	29,4%
Center axle.....	35,4%
Rear axle.....	35,2%

BODY

Capacity:	
Struck	18,2 m ³
Heaped (2:1, SAE).....	24,0 m ³
Payload.....	40 tons
Material.....	130 kg/mm ² high tensile strength steel
Material thickness:	
Bottom	14 mm
Front.....	8 mm
Sides	12 mm
Target area (inside length × width).....	5.667 mm × 3.194 mm
Heating	Exhaust heating (option)



Dimensions & Performance Figures

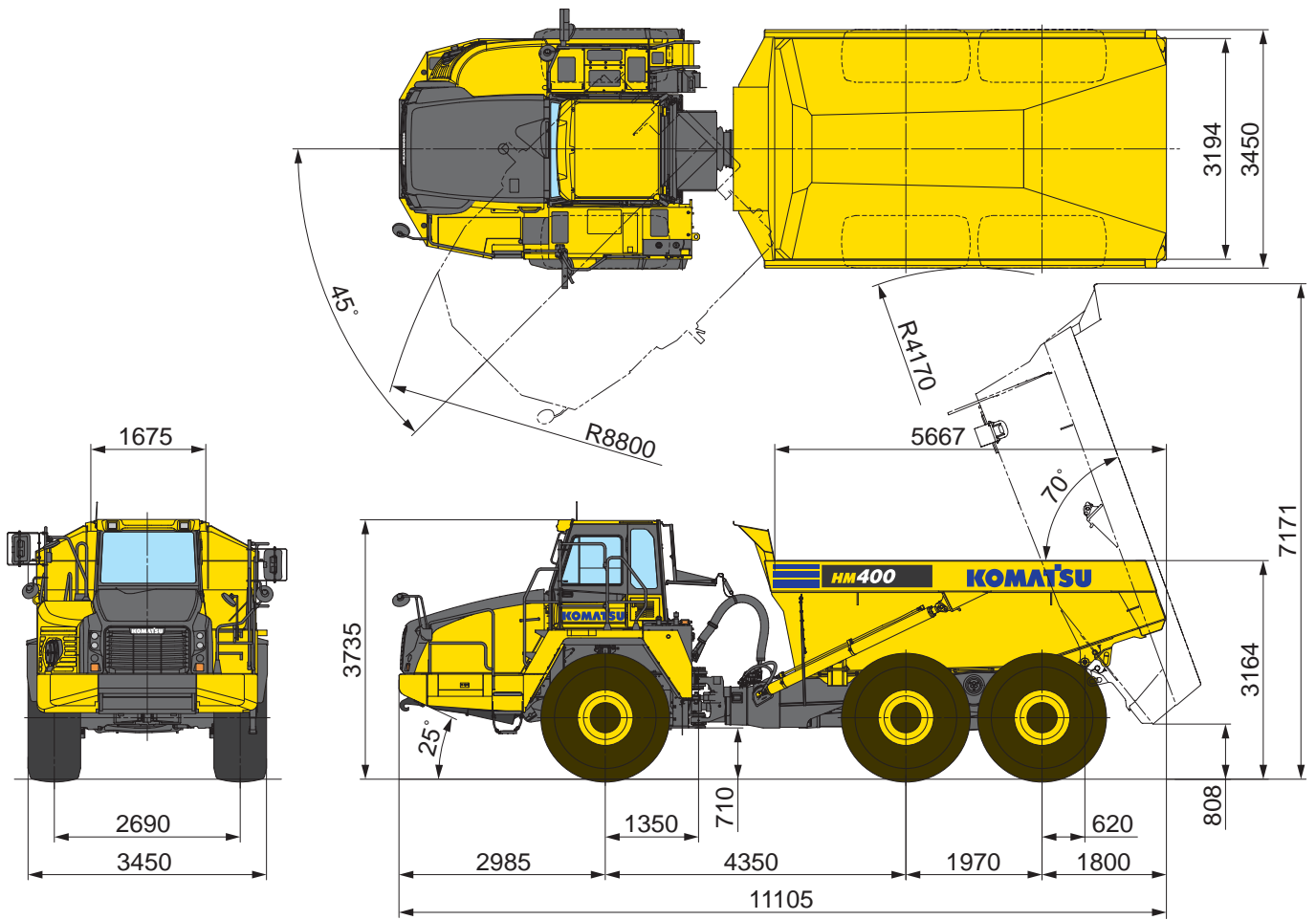

All measurements with tyres 29.5 R25



TRAVEL PERFORMANCE

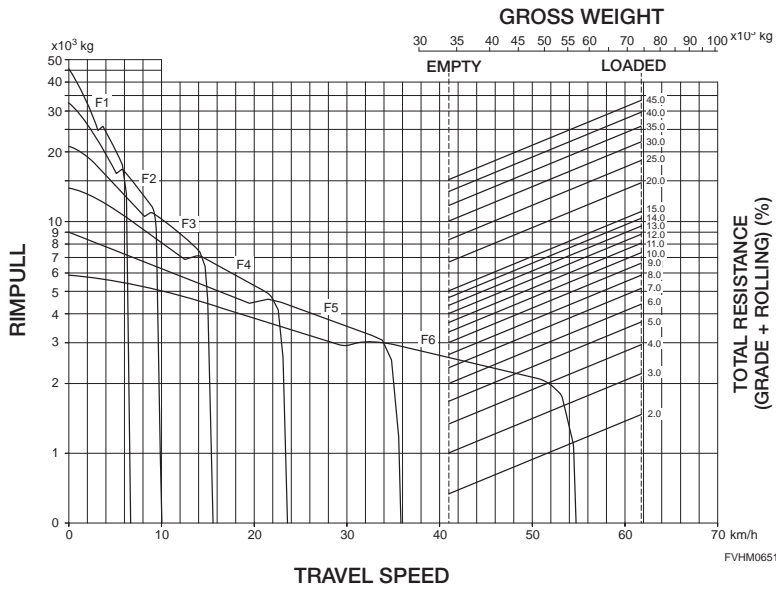

BRAKE PERFORMANCE

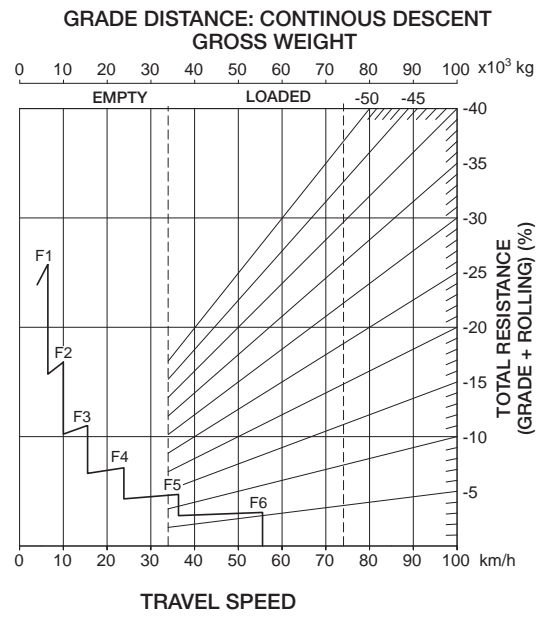

Articulated Dump Truck

HM400-3

Standard and Optional Equipment

ENGINE

Komatsu SAA6D140E-6 turbocharged common rail direct injection diesel engine	●
EU Stage IIIB/EPA Tier 4 interim compliant	
Komatsu Diesel Particulate Filter (KDPF)	●
Alternator 90 A/24 V	●
Starter motor 11 kW/24 V	●
Batteries 2 × 12 V/136 Ah	●

BODY

Electronic hoist control system	●
Body exhaust heating kit	○
Body liner	○
Tail gate, wire type, overall width 2.998 mm	○
Body side extension, 200 mm	○

AXLES AND TYRES

Komatsu Traction Control System	●
Tyres 29.5 R25	●
Tyres 30/65 R25 (750/65 R25)	○

SERVICE AND MAINTENANCE

Centralized greasing	●
Large TFT colour monitor panel	●
KOMTRAX™ - Komatsu wireless monitoring system	●
Toolkit and spare parts for first service	●
Vandalism protection	●
Gas charge tool for suspension cylinders	○

CABIN

Tilting (electrically) ROPS/FOPS cab, sound suppression type	●
Operator seat, reclining, air suspension type with 75 mm width 3-point seat belt	●
Trainer seat with 2-point seat belt	●
Steering wheel, tilt and telescopic	●
Air conditioner	●
Heated rear window (electric)	●
Power window (l.h.)	●
Sun visor, front window	●
Body dump counter	●
Cigarette lighter, ashtray, cup holder, space for lunch box	●
Pre radio installation kit	●
Power mode, economy mode	●
Odometer	●
ECO drive guidance	●
12 Volt power supply	●

SAFETY EQUIPMENT

Back-up alarm	●
Anti-slip material on fenders	●
Automatic supplementary steering	●
Coolant temperature alarm and light	●
Electric circuit breaker, 24 V	●
Hand rails for platform	●
Horn, electric	●
Ladders, left and right hand side	●
Protective grille for rear window	●
Protective fence around engine hood	●
Rear-view mirrors (heated)	●
Under-view mirrors	●
Steering joint locking assembly	●
Side marker	●
Rear view camera system	●
Side inclination caution alarm	●
Fire extinguisher	○

LIGHTING SYSTEM

Back-up light	●
Turn indicator lights front/rear with hazard function	●
Headlights high and low beam with dimmer switch	●
Stop and tail lights	●
Side lamps back cabin	●
Back work lights, left and right side	○
Fog lights	○

OTHER EQUIPMENT

Mud guards	●
Engine underguard	●
Propeller shaft guards, front and rear	●
Transmission underguard	●
Komatsu Diesel Particulate Filter (KDPF) thermal guard	●
Fire prevention covers	●
Automatic retarder with acceleration control (ARAC)	●
Tool box storage compartment	●

Further equipment on request

- standard equipment
- optional equipment

Your Komatsu partner:

KOMATSU

**Komatsu Europe
International NV**

Mechelsesteenweg 586
B-1800 VILVOORDE (BELGIUM)
Tel. +32-2-255 24 11
Fax +32-2-252 19 81
www.komatsu.eu

EESS020100 05/2012

Materials and specifications are subject to change without notice.
KOMATSU is a trademark of Komatsu Ltd. Japan.