

KOMATSU[®]

PC138USLC-10

Tier 4 Interim Engine

NET HORSEPOWER

OPERATING WEIGHT

BUCKET CAPACITY

PC138USLC



PHOTOS MAY INCLUDE OPTIONAL EQUIPMENT

PC138USLC

WALK-AROUND

PC138USLC-10



Photos may include optional equipment

PC138USLC-10

Tier 4 Interim Engine

NET HORSEPOWER

93.5 HP @ 2050rpm
68.8 kW @ 2050rpm

OPERATING WEIGHT

31,791–32,628 lb
14420–14800 kg

BUCKET CAPACITY

0.34–1.00 yd³
0.26–0.76 m³



CONVENTIONAL PERFORMANCE IN A TIGHT TAIL BODY

Standard additional counterweight provides equal or better lift capacity than most conventional excavators in the same size class.

Rounded cab profile allows the cab to swing within the same swing radius as the counterweight for true tight tail performance.

A powerful Komatsu SAA4D95LE-6 engine provides a net output of 68.8 kW **93.5 HP**. This engine is EPA Tier 4 Interim and EU stage 3B emissions certified.

Variable Flow Turbocharger provides optimum air flow under all speed and load conditions.

Komatsu Diesel Oxidation Catalyst (KDOC) reduces particulate matter using passive regeneration **100% of the time**. No active or manual regeneration is required.

Komatsu's Closed-center Load Sensing System (CLSS) provides quick response and smooth operation to maximize productivity.

Enhanced working modes are designed to match engine speed, pump delivery, and system pressure to the application.

Large LCD color monitor panel:

- 7" high resolution screen
- Provides "Ecology Guidance" for fuel efficient operation
- Enhanced attachment control

Aux jack and (2) 12V outlets

Rearview monitoring system (standard)

Equipment Management Monitoring System (EMMS)

continuously monitors machine operation and vital systems to identify machine issues and assist with troubleshooting.

Enhanced working environment

- Integrated ROPS cab design (ISO 12117-2)
- Cab meets ISO Level 1 Operator Protective Guard (OPG) top guard (ISO 10262)

Wide access service doors

provide easy access for ground level maintenance.



Komatsu designed and manufactured components

New engine and hydraulic control technology improves operational efficiency and lowers fuel consumption by up to 7%.

Guardrail (standard) provides convenient access to the upper structure.

Battery disconnect switch

allows a technician to disconnect the power supply before servicing the machine.

KOMTRAX®

Komtrax equipped machines can send location, SMR and operation maps to a secure website utilizing wireless technology. Machines also relay error codes, cautions, maintenance items, fuel levels, and much more.

Environment-Friendly Engine

The Komatsu SAA4D95LE-6 engine is EPA Tier 4 Interim and EU Stage 3B emissions certified and provides exceptional performance while reducing fuel consumption. Based on Komatsu proprietary technologies developed over many years, this new diesel engine reduces exhaust gas particulate matter (PM) by more than 90% and nitrogen oxide (NOx) by more than 20%, compared to Tier 3 levels. Through the in-house development and production of engines, electronics, and hydraulic components, Komatsu has achieved great advancements in technology providing high levels of performance and efficiency in virtually all applications.

Newly designed Variable Flow Turbocharger (VFT)

A newly designed variable flow turbocharger features simple and reliable technology that varies the intake airflow. This provides optimum air flow under all speed and load conditions producing cleaner exhaust gas without sacrificing power and performance.

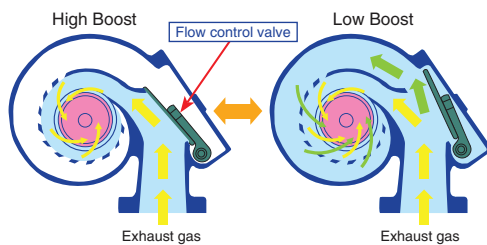

Advanced Electronic Control System

The engine control system has been upgraded to effectively manage a variety of parameters such as the air flow rate, EGR gas flow rate, fuel injection parameters, and aftertreatment functions. The new control system also provides enhanced diagnostic capabilities.

Cooled Exhaust Gas Recirculation (EGR)

Cooled EGR, a technology that has been well proven in Komatsu Tier 3 engines, reduces NOx emission to meet Tier 4 levels. The EGR system has increased capacity and uses larger and more robust components to ensure reliability for demanding work conditions.

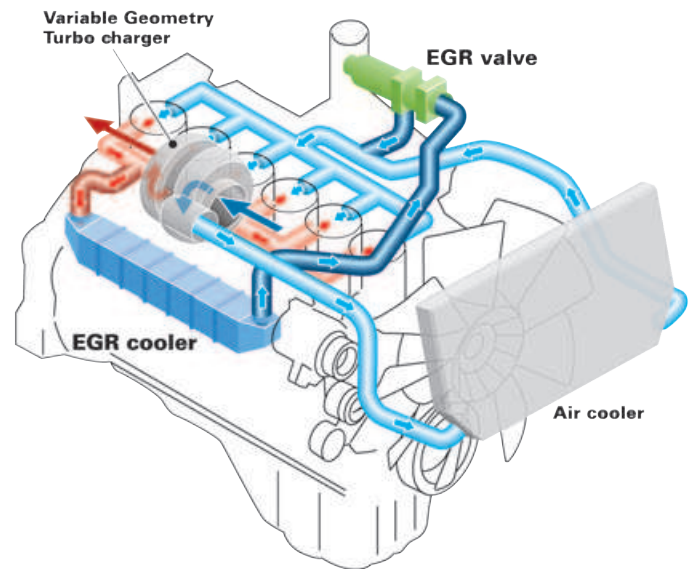

Komatsu Diesel Oxidation Catalyst (KDOC)

The new Komatsu Diesel Oxidation Catalyst (KDOC) has an integrated design that does not interfere with daily operation. This smart and simplified system removes soot using **100% "passive regeneration"** without the need for a Diesel Particulate Filter. The KDOC is a simple design and does not have a scheduled service interval like a DPF and is designed for long life with no scheduled maintenance required. For owners, this means lower Owning and Operating costs due to less complexity and seamless operation.

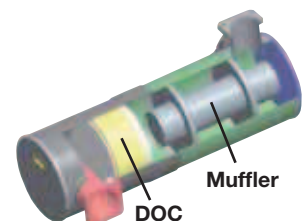



Efficient Hydraulic System

The PC138USLC-10 uses a Closed-center Load Sensing System (CLSS) that improves fuel efficiency and provides quick response to the operator's demands.

The PC138USLC-10 also introduces new technology to enhance the engine and hydraulic pump control. This total control system matches the engine and hydraulics at the most efficient point under any load condition. There have also been improvements in the main valve and hydraulic circuit to reduce hydraulic loss, resulting in higher efficiency and lower fuel consumption.

Reduced Up To 7% Fuel consumption

vs PC138USLC-8
Based on typical work pattern collected via KOMTRAX

Working Mode Selection

The PC138USLC-10 excavator is equipped with six working modes (P, E, L, B, ATT/P and ATT/E). Each mode is designed to match engine speed, pump flow, and system pressure to the application. The PC138USLC-10 features a new mode (ATT/E) which allows operators to run attachments while in Economy mode.

Working Mode	Application	Advantage
P	Power mode	<ul style="list-style-type: none"> •Maximum production/power •Fast cycle times
E	Economy mode	<ul style="list-style-type: none"> •Good cycle times •Better fuel economy
L	Lifting mode	<ul style="list-style-type: none"> •Increases hydraulic pressure
B	Breaker mode	<ul style="list-style-type: none"> •Optimum engine rpm, hydraulic flow
ATT/P	Attachment Power mode	<ul style="list-style-type: none"> •Optimum engine rpm, hydraulic flow, 2-way •Power mode
ATT/E	Attachment Economy mode	<ul style="list-style-type: none"> •Optimum engine rpm, hydraulic flow, 2-way •Economy mode

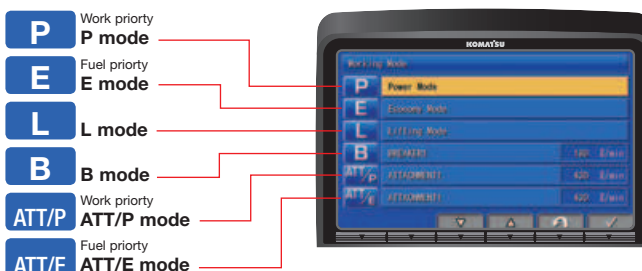

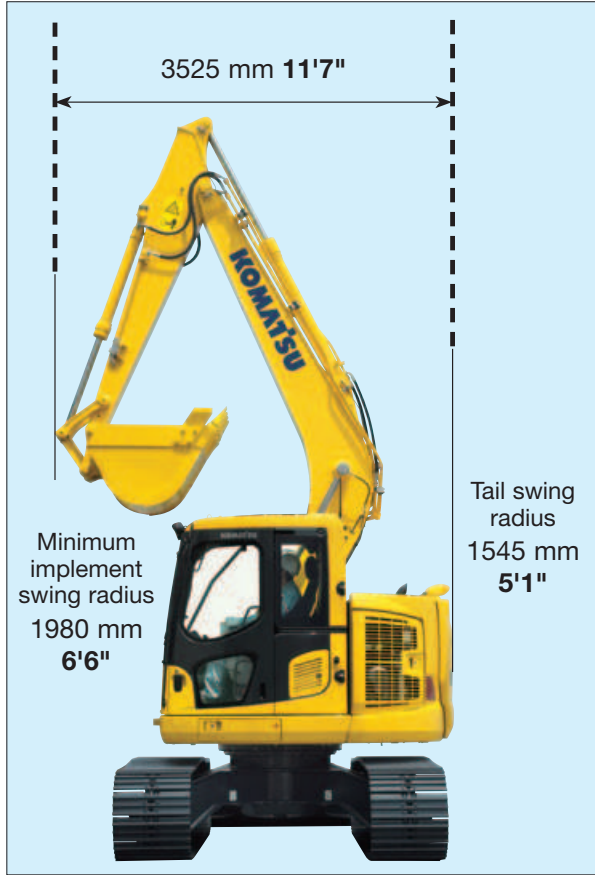

Short Implement Swing Radius

The 1980 mm **6'6"** boom raising angle of the PC138USLC-10 is larger than a conventional profile excavator, reducing the front implement swing radius.

Short Tail Swing Radius

A short tail swing radius allows the machine to work in more confined areas than a conventional excavator. A standard additional counterweight wrap provides the PC138USLC-10 with increased lifting capacity, equivalent to most conventional excavators with minimal increase in the swing radius.

Ideal For Confined Applications

The PC138USLC-10 is an ideal machine for applications such as roadwork, logging and forestry roadwork, and demolition. The tight tail design minimizes the amount of overhang when swinging over the side. This allows a truck to be positioned closer to the machine to improve operator efficiency and allows the machine to work within one lane traffic.

True Tight Tail Performance

The versatile PC138USLC-10 can fit into areas where a conventional machine cannot. The contoured cab design and convex sliding door allow the cab to swing within the same turning radius as the counterweight.

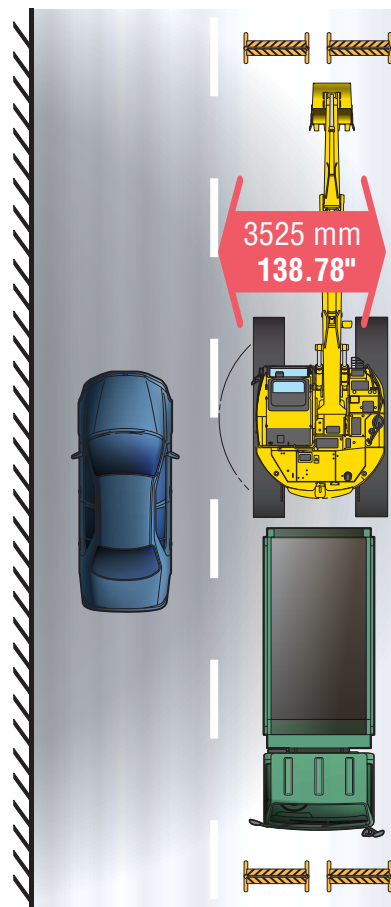
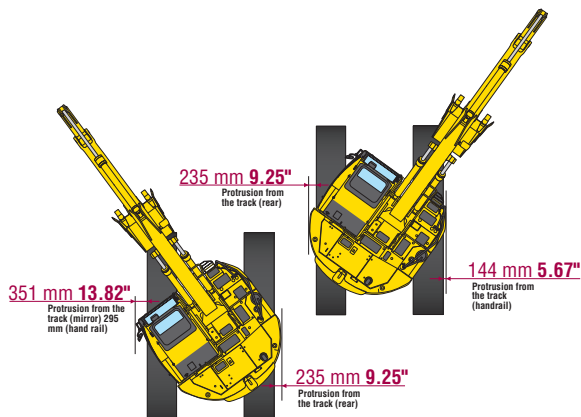

RELIABILITY FEATURES

High Rigidity Work Equipment

Booms and arms are constructed with thick plates of high tensile strength steel. In addition, these structures are designed with large cross-sectional areas and large one piece castings in the boom foot and the boom tip. The result is work equipment that exhibits long term durability and high resistance to bending and torsional stress.



Komatsu Designed Components

All of the major machine components such as the engine, hydraulic pumps, hydraulic motors, and control valves are exclusively designed and manufactured by Komatsu.

O-Ring Face Seals

Flat face-to-face O-ring seals are used to securely seal hydraulic hose connections.



Durable Frame Structure

The revolving frame, center frame, and undercarriage are designed using the most advanced three dimensional CAD and FEM analysis technology.



Grease Sealed Track

The PC138USLC-10 uses grease sealed tracks for extended undercarriage life.

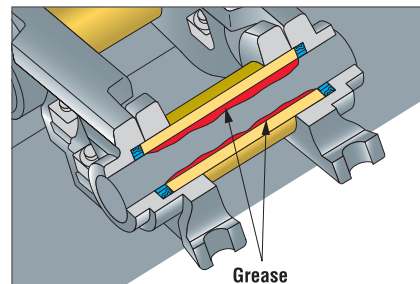

Metal Guard Rings

The PC138USLC-10 uses metal guard rings to protect all of the hydraulic cylinders and improve long term reliability.

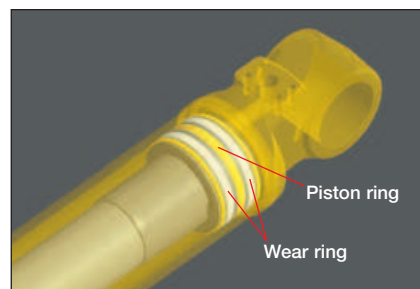

Durable Arm Tip Bushing

The end face of the arm tip bushing provides high resistance to seizure and wear.

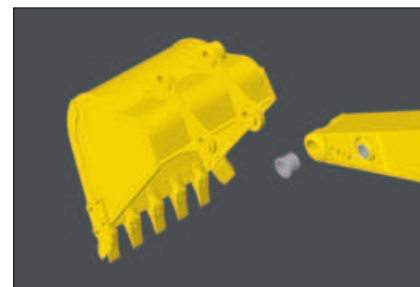



Newly Designed Wide Spacious Cab

The newly designed wide spacious cab features a high back, fully adjustable seat with a reclining backrest. The console and seat have an integrated design so that they move together and provide additional comfort for the operator.

The new higher capacity operator seat has been enhanced to provide more comfort.

- Integrated Seat
- Console Mounted Arm Rests

Auxiliary Input (MP3 Jack)

By connecting an auxiliary device such as an MP3 player to the auxiliary input, the operator can hear the sound through the speakers installed in the cab.



Pressurized Cab

The air conditioner, air filter, and a higher internal cab air pressure minimize the amount of external dust that enters the cab.

Automatic Air Conditioner

The automatic air conditioner allows the operator to easily and precisely set the cab atmosphere using the large LCD color monitor panel. The bi-level control function improves air flow and keeps the inside of the cab comfortable throughout the year.



Low Vibration with Viscous Cab Mounts

The PC138USLC-10 uses viscous mounts for the cab that incorporate a longer stroke and the addition of a spring. The cab damper mounting combined with a high rigidity deck reduces vibration at the operator's seat.

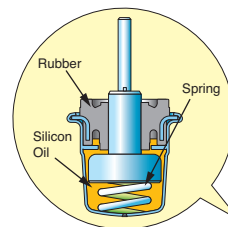



Large High Resolution LCD Monitor Panel

A new large, user-friendly, high resolution LCD color monitor enables accurate and smooth work. Screen visibility and resolution are further improved compared to the previous LCD monitor panel. The switches and function keys are easy to operate and provide simple navigation through the monitor screens.

Data is displayed in 25 languages to support operators around the world.

Indicators

- | | |
|----------------------------------|-----------------------------------|
| 1 Auto-decelerator | 5 Hydraulic oil temperature gauge |
| 2 Working mode | 6 Fuel gauge |
| 3 Travel speed | 7 Ecology gauge |
| 4 Engine water temperature gauge | 8 Fuel consumption gauge |
| | 9 Function switches menu |

Basic operation switches

- | | |
|-------------------------|---------------------|
| 1 Auto-decelerator | 4 Buzzer cancel |
| 2 Working mode selector | 5 Wiper |
| 3 Traveling selector | 6 Windshield washer |

Operational Information

The monitor panel provides operational advice to the operator to help improve machine efficiency and lower fuel consumption. The operator can access the ecology guidance menu to check the Operation Records, Ecology Guidance Records, and Average Fuel Consumption records.

Improved Attachment Control

The PC138USLC-10 is capable of storing up to ten different attachments in the new monitor panel. The name of each attachment can be changed for better tool management. Hydraulic flow rates can be easily adjusted for one-way and two-way flow attachments.



Ecology Guidance

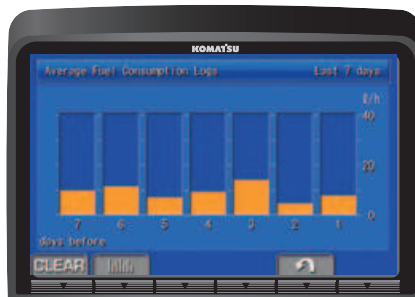

Average Fuel Consumption Logs

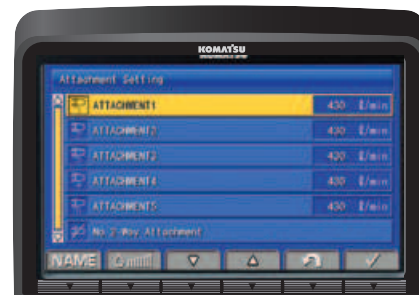

Attachment Setting Screen



Operation Records



Attachment Settings

Easy Access Coolers

The radiator and oil cooler are side-by-side modules which simplifies cleaning, removing, and installing. The swing out cooler design provides easier access to the cooling cores.



Battery Disconnect Switch

A standard battery disconnect switch allows a technician to disconnect the power supply and lock out before servicing the machine.



Long Life Oils, Filters

High performance filters are used in the hydraulic circuit and engine. By increasing the oil and filter replacement intervals, maintenance costs can be significantly reduced.



Hydraulic oil filter
(Ecology-white element)

Engine oil & Engine oil filter	every 500 hours
Hydraulic oil	every 5000 hours
Hydraulic oil filter	every 1000 hours

Extended Work Equipment Greasing Intervals

Special hard material is used for the work equipment bushings to lengthen the greasing intervals. All work equipment bushing lubrication intervals, except the arm tip and bucket linkage, are 500 hours, reducing maintenance costs.

Large Tool Box

Large tool box provides plenty of space. Grease pump storage space is also provided.



High Efficiency Fuel Filters

Komatsu's pre-filter and water separator comes with a built in priming pump. A new high efficiency dual element fuel filter provides twice the filtration capacity.



Equipment Management Monitoring System (EMMS)

The PC138USLC-10 features an advanced diagnostic system that continuously monitors the machine's vital systems. EMMS tracks maintenance items, provides advanced troubleshooting tools, reduces diagnostic times, and displays error codes.

Through continuous monitoring, the EMMS helps identify issues before they become worse and allows the operator to concentrate on the work at hand.

Maintenance Tracking

When the machine approaches or exceeds the oil and filter replacement interval, the monitor panel will display lights to inform the operator.

Maintenance	Interval	Remain
Air Cleaner Cleaning / Change	—	—
Engine Oil Change	500 h	488 h
Engine Oil Filter Change	500 h	488 h
Fuel Main Filter Change	1000 h	988 h
Fuel Pre Filter Change	500 h	488 h

Abnormalities Display with Code

When an abnormality occurs an error code is displayed on the monitor. When an important code is displayed, a caution lamp blinks and warning buzzer sounds to alert the operator to take action.

The monitor also stores a record of abnormalities for more effective troubleshooting.



Advanced Monitoring System

The monitor provides advanced monitoring diagnostics to assist with troubleshooting and reduce costly downtime.

Monitoring / Pre-defined(01/14)	
01002 Engine Speed	0 r/min
04107 Coolant Temperature	0 °C
37212 Engine Oil Switch	ON
18400 Intake Temperature	0.0 °C
04401 Hydr. Oil Temperature	0.0 °C
02002 Battery Power Supply	0.0 V



Photos may include optional equipment

ROPS Cab Design

The PC138USLC-10 is equipped with an integrated ROPS cab as standard equipment. The cab also meets OPG Top Guard Level 1 requirements.

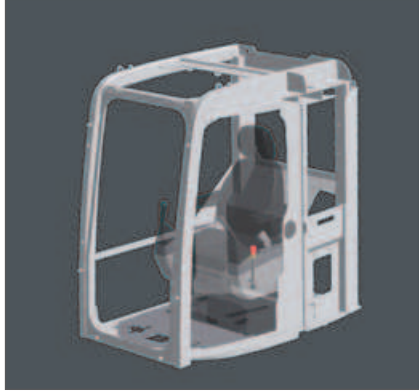

Rear View Monitoring System

The operator can view the rear of the machine with a color monitor screen.



Rear view image on monitor

Slip Resistant Plates

Durable slip resistant plates maintain excellent foot traction.



Pattern Change Valve Standard

A pattern change valve is conveniently located at the front of the machine, making switching from excavator controls to backhoe controls quick and easy.

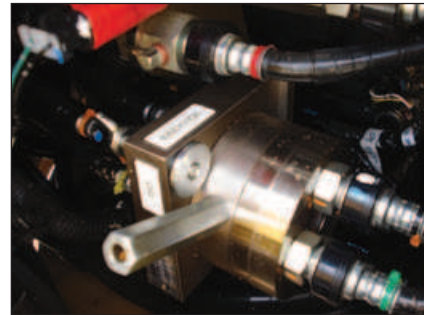

Blade Provisions

Every PC138USLC-10 comes with provisions to install a wide 2590mm **8'6"** blade.



KOMTRAX EQUIPMENT MONITORING

GET THE WHOLE STORY WITH
KOMTRAX[®]

✓ WHAT

- KOMTRAX is Komatsu's remote equipment monitoring and management system
- KOMTRAX **continuously monitors and records** machine health and operational data
- Information such as fuel consumption, utilization, and a detailed history **aids in making repair or replacement decisions**

✓ WHEN

- Know when your machines are **running or idling** and make decisions that will improve your fleet utilization
- Detailed movement records ensure you know when and where your equipment is moved
- Up to date records allow you to **know when maintenance was done** and help you plan for future maintenance needs

✓ WHERE

- KOMTRAX data **can be accessed virtually anywhere** through your computer, the web or your smart phone
- Automatic alerts keep fleet managers up to date on the latest machine notifications

✓ WHY

- Knowledge is power - **make informed decisions** to manage your fleet better
- Knowing your idle time and fuel consumption will help maximize your machine efficiency
- **Take control of your equipment** - any time, anywhere

✓ WHO

- KOMTRAX is **standard** equipment on all Komatsu construction products



Monthly Operational Analysis

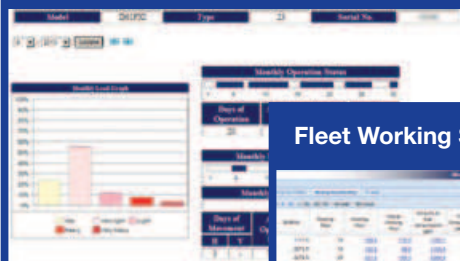

Fleet Working Status

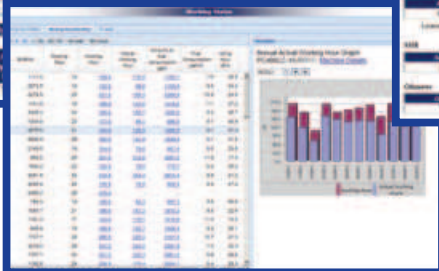

Location/Hours/Working



KOMTRAX[®]

For construction and compact equipment.

KOMTRAX Plus[™]

For production and mining class machines.



Komatsu CARE – Complimentary Scheduled Maintenance

- PM services for the earlier of 3 years / 2000 hours
- Performed by factory certified technicians
- Komatsu Genuine parts and fluids
- Significantly lowers your cost of ownership while maintaining high uptime and reliability
- Increases resale value and provides detailed maintenance records
- Extended PM services can be purchased beyond the complimentary period to provide additional peace of mind and maximize uptime



Komatsu CARE – Extended Coverage

- Extended Coverage can provide peace of mind by protecting customers from unplanned expenses that effect cash flow
- Purchasing extended coverage locks-in the cost of covered parts and labor for the coverage period and helps turn these into fixed costs



Komatsu Parts Support

- 24/7/365 to fulfill your parts needs
- 9 parts Distribution Centers strategically located across the U.S. and Canada
- Distributor network of more than 300 locations across U.S. and Canada to serve you
- Online part ordering through Komatsu eParts
- Remanufactured components with same-as-new warranties at a significant cost reduction



Komatsu Oil and Wear Analysis (KOWA)

- KOWA detects fuel dilution, coolant leaks, and measures wear metals
- Proactively maintain your equipment
- Maximize availability and performance
- Can identify potential problems before they lead to major repairs
- Reduce life cycle cost by extending component life

SPECIFICATIONS



ENGINE

Model.....Komatsu SAA4D95LE-6*
 Type.....Water-cooled, 4-cycle, direct injection
 Aspiration..... Variable flow, turbocharged, air-to-air aftercooled
 Number of cylinders..... 4
 Bore..... 95 mm **3.74"**
 Stroke..... 115 mm **4.53"**
 Piston displacement.....3.26 ltr **199 in³**
 Horsepower:
 SAE J1995.....Gross 72 kW **98 HP**
 ISO 9249 / SAE J1349.....Net 68 kW **93 HP**
 Rated rpm..... 2050
 Governor.....All-speed control, electronic
 Lubrication system:
 Method.....Gear pump, force-lubrication
 Filter..... Full-flow
 Air cleaner..... Dry type with double elements
 and auto dust evacuator, plus dust indicator
 *EPA Tier 4 Interim and EU stage 3B emissions certified



HYDRAULICS

Type.....HydrauMind (Hydraulic Mechanical Intelligence New Design) system, closed-center system with load sensing valve and pressure compensated valve
 Main pump:
 Type.....Variable capacity piston type
 Pumps for.....Boom, arm, bucket, swing, and travel circuits
 Maximum flow..... 242 ltr/min **64 gal/min**
 Hydraulic motors:
 Travel..... 2 x piston motor with parking brake
 Swing..... 1 x piston motor with swing holding brake
 Relief valve setting:
 Implement circuits..... 34.8 MPa 355 kgf/cm² **5,050 psi**
 Swing circuit..... 27.1 MPa 276 kgf/cm² **3,920 psi**
 Pilot circuit..... 3.2 MPa 33 kgf/cm² **470 psi**
 Hydraulic cylinders:
 (Number of cylinders – bore x stroke)
 Boom..... 2–105 mm x 1055 mm **4.1" x 41.5"**
 Arm..... 1–110 mm x 1175 mm **4.3" x 46.3"**
 Bucket..... 1–95 mm x 885 mm **3.7" x 34.8"**



DRIVES AND BRAKES

Steering control..... Two levers with pedals
 Drive method..... Fully hydrostatic
 Maximum drawbar pull..... 123 kN 12500 kgf **27,560 lbf**
 Maximum travel speed: High..... 5.1 km/h **3.2 mph**
 Low..... 2.9 km/h **1.8 mph**
 Service brake..... Hydraulic lock
 Parking brake..... Wet, multiple-disc



SWING SYSTEM

Driven by..... Hydraulic motor
 Swing reduction..... Planetary gear
 Swing circle lubrication..... Grease-bathed
 Swing lock..... Wet, multiple-disc brake
 Swing speed..... 11.0 rpm
 Swing torque..... 2991 kg•m **21,627 ft lbs**



UNDERCARRIAGE

Center frame..... X-frame leg
 Track frame..... Box-section
 Track type..... Sealed track
 Track adjuster..... Hydraulic
 Number of shoes (each side)..... 46
 Number of carrier rollers (each side)..... 2
 Number of track rollers (each side)..... 8



COOLANT & LUBRICANT CAPACITY (REFILLING)

Fuel tank..... 200 ltr **52.8 U.S. gal**
 Radiator..... 16.7 ltr **4.4 U.S. gal**
 Engine..... 11.5 ltr **3.0 U.S. gal**
 Final drive, each side..... 2.1 ltr **.55 U.S. gal**
 Swing drive..... 2.5 ltr **0.7 U.S. gal**
 Hydraulic tank..... 69.0 ltr **18.2 U.S. gal**



OPERATING WEIGHT (APPROXIMATE)

Operating weight includes 4600 mm **15'1"** one-piece boom, 2500 mm **8'2"** arm, SAE heaped 0.5 m³ **0.65 yd³** backhoe bucket, rated capacity of lubricants, coolant, full fuel tank, operator, and standard equipment.

Triple-Grouser Shoes	Operating Weight	Ground Pressure
500 mm	14420 kg	45.1 kPa / 0.46 kg/cm²
20"	31,791 lb	6.54 psi
600 mm	14600 kg	38.2 kPa / 0.39 kg/cm²
24"	32,187 lb	5.55 psi
700 mm	14800 kg	33.3 kPa / 0.34 kg/cm²
28"	32,628 lb	4.83 psi

Component Weights

Arm including bucket cylinder and linkage

2500 mm **8'2"** arm assembly..... 529 kg **1,166 lb**
 2500 mm **8'2"** arm assembly w/piping..... 558 kg **1,230 lb**
 3000 mm **9'10"** arm assembly..... 643 kg **1,418 lb**
 3000 mm **9'10"** arm assembly w/piping..... 678 kg **1,498 lb**

One piece boom including arm cylinder

4600 mm **15'1"** boom..... 943 kg **2,079 lb**
 Counterweight (standard)..... 3550 kg **7,826 lb**
 0.50 m³ **0.65 yd³** bucket - 24" width..... 400 kg **883 lb**



DIMENSIONS

Arm Length	2500 mm	8'2"	3000 mm	9'10"
Boom length	4600 mm	15'1"	4600 mm	15'1"
A Overall length	7385 mm	24'3"	7285 mm	23'11"
B Overall height (to top of boom)*	2850 mm	9'4"	3210 mm	10'6"
C Length on ground (transport)	4540 mm	14'11"	4400 mm	14'5"
D Overall width	2590 mm	8'6"		
E Overall height (to top of cab)*	2815 mm	9'3"		
F Ground clearance, counterweight	900 mm	2'11"		
G Ground clearance, minimum	395 mm	1'4"		
H Tail swing radius	1545 mm	5'1"		
I Track length on ground	3140 mm	10'4"		
J Track length	3870 mm	12'8"		
K Track gauge	1990 mm	6'6"		
L Width of crawler	2590 mm	8'6"		
M Shoe width	600 mm	24"		
N Grouser height	20 mm	0.8"		
O Machine height to top of counterweight	1980 mm	6'6"		
P Machine upper width	2490 mm	8'2"		
Q Distance, swing center to rear end	1545 mm	5'1"		

* : Including grouser height

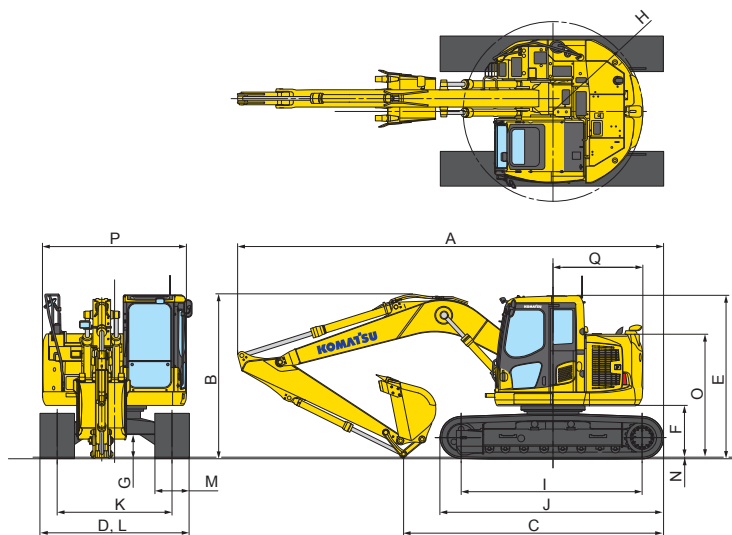

BACKHOE BUCKET, ARM AND BOOM COMBINATION

Bucket Type	Bucket						Arms	
	Capacity		Width		Weight		2.5 m (8'2")	3.0 m (9'10")
Komatsu GSK	0.26 m ³	0.34 yd³	457 mm	18"	332 kg	732 lb	V	V
	0.38 m ³	0.50 yd³	610 mm	24"	387 kg	853 lb	V	V
	0.51 m ³	0.67 yd³	762 mm	30"	437 kg	963 lb	V	V
	0.63 m ³	0.83 yd³	914 mm	36"	499 kg	1,099 lb	W	X
	0.76 m ³	1.00 yd³	1067 mm	42"	559 kg	1,232 lb	X	Y
Komatsu HP	0.26 m ³	0.34 yd³	457 mm	18"	379 kg	836 lb	V	V
	0.31 m ³	0.40 yd³	508 mm	20"	396 kg	873 lb	V	V
	0.38 m ³	0.50 yd³	610 mm	24"	457 kg	1,007 lb	V	V
	0.51 m ³	0.67 yd³	762 mm	30"	517 kg	1,140 lb	V	W
	0.63 m ³	0.83 yd³	914 mm	36"	591 kg	1,303 lb	W	X
Komatsu HPS	0.76 m ³	1.00 yd³	1067 mm	42"	664 kg	1,464 lb	Y	Z
	0.26 m ³	0.34 yd³	457 mm	18"	406 kg	895 lb	V	V
	0.31 m ³	0.40 yd³	508 mm	20"	426 kg	939 lb	V	V
	0.38 m ³	0.50 yd³	610 mm	24"	493 kg	1,086 lb	V	V
	0.51 m ³	0.67 yd³	762 mm	30"	562 kg	1,240 lb	V	W
Komatsu HPS	0.63 m ³	0.83 yd³	914 mm	36"	645 kg	1,423 lb	X	Y
	0.76 m ³	1.00 yd³	1067 mm	42"	728 kg	1,605 lb	Y	Z

V - Used with material weights up to 3,500 lb/yd³
 X - Used with material weights up to 2,500 lb/yd³
 Z - Not useable

W - Used with material weights up to 3,000 lb/yd³
 Y - Used with material weights up to 2,000 lb/yd³



WORKING RANGE

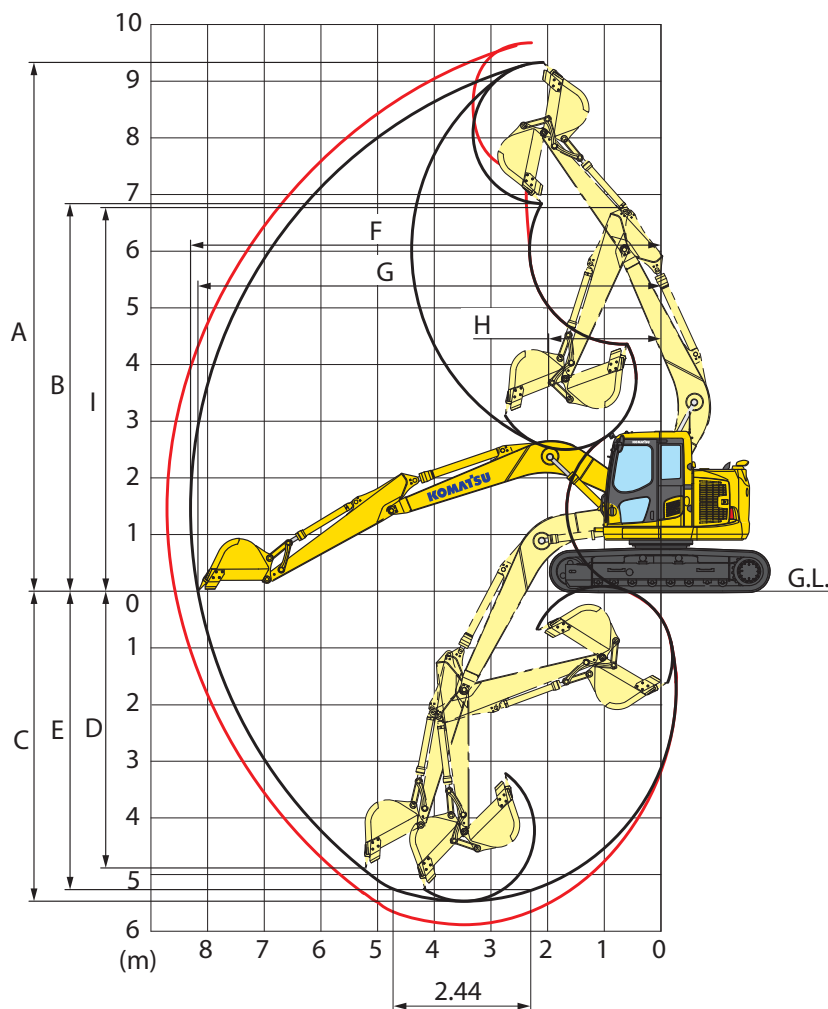

	Arm Length	2500 mm	8'2"	3000 mm	9'10"
A	Max. digging height	9340 mm	30'8"	9700 mm	31'10"
B	Max. dumping height	6840 mm	22'5"	7350 mm	24'1"
C	Max. digging depth	5480 mm	18'0"	5900 mm	19'4"
D	Max. vertical wall digging depth	4900 mm	16'1"	5340 mm	17'6"
E	Max. digging depth for 8' level bottom	5265 mm	17'3"	5715 mm	18'9"
F	Max. digging reach	8300 mm	27'3"	8720 mm	28'7"
G	Max. digging reach at ground level	8180 mm	26'10"	8600 mm	28'3"
H	Min. swing radius	1980 mm	6'6"	2264 mm	7'5"
I	Max. height at min. swing radius	6770 mm	22'3"	6770 mm	22'3"
SAE rating	Bucket digging force	81.4 kN		78.0 kN	
		8300 kg / 18,300 lb		7950 kg / 17,530 lb	
	Arm crowd force	60.8 kN		54.4 kN	
		6200 kgf / 13,670 lb		5550 kgf / 12,240 lb	
ISO rating	Bucket digging force	93.2 kN		88.3 kN	
		9500 kg / 20,950 lb		9000 kg / 19,840 lb	
	Arm crowd force	61.8 kN		55.9 kN	
		6300 kgf / 13,890 lb		5700 kgf / 12,570 lb	

LIFT CAPACITIES



LIFTING CAPACITY WITH LIFTING MODE

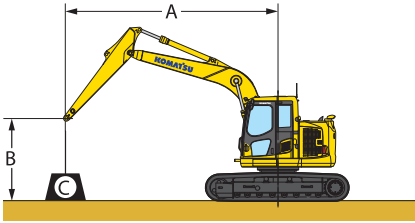

- A: Reach from swing center
- B: Bucket hook height
- C: Lifting capacity
- Cf: Rating over front
- Cs: Rating over side
- ⊗ : Rating at maximum reach

- Conditions :
- 4600 mm 15' 1" one-piece boom
 - Counterweight (Standard): 3550 kg 7,826 lb
 - Bucket: None
 - Lifting mode: On
 - No blade

Arm: 2500 mm 8'2" Shoes: 500 mm 20" Unit: kg lb

B	A		1.5 m 5'		3.0 m 10'		4.6 m 15'		6.1 m 20'		7.6 m 25'		⊗ MAX	
	Cf	Cs	Cf	Cs	Cf	Cs	Cf	Cs	Cf	Cs	Cf	Cs	Cf	Cs
7.6 m 25'													* 2500	* 2500
6.1 m 20'							* 3360	* 3360					* 2010	* 2010
4.6 m 15'							* 7420	* 7420					* 4430	* 4430
3.0 m 10'							* 3730	* 3730	* 3010	2490			* 1870	* 1870
1.5 m 5'							* 8220	* 8220	* 6650	5500			* 4140	* 4140
0 m 0'							* 6000	* 6000	* 4600	3730	3890	2440	* 1870	* 1870
-1.5 m -5'	* 3920	* 3920	* 9030	5910	5600	3270	3660	2230					* 2680	2000
-3.0 m -10'	* 8640	* 8640	* 19920	13030	12340	7210	8080	4920					* 5920	4420
-4.6 m -15'	* 7540	* 7540	* 7570	5980	5240	3290							* 3790	5460
	* 16620	* 16620	* 16700	13200	* 11570	7260							* 8350	5460

*Load is limited by hydraulic capacity rather than tipping. Ratings are based on ISO standard No. 10567. Rated loads do not exceed 87% of hydraulic lift capacity or 75% of tipping load.

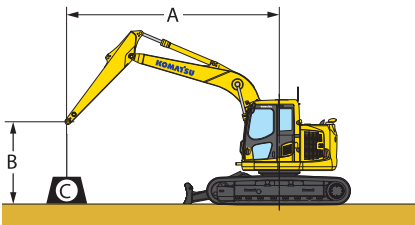

- A: Reach from swing center
- B: Bucket hook height
- C: Lifting capacity
- Cf: Rating over front
- Cs: Rating over side
- ⊗ : Rating at maximum reach

- Conditions :
- 4600 mm 15' 1" one-piece boom
 - Counterweight (Standard): 3550 kg 7,826 lb
 - Bucket: None
 - Lifting mode: On
 - Blade included

Arm: 2500 mm 8'2" Shoes: 500 mm 20" Unit: kg lb

B	A		1.5 m 5'		3.0 m 10'		4.6 m 15'		6.1 m 20'		7.6 m 25'		⊗ MAX	
	Cf	Cs	Cf	Cs	Cf	Cs	Cf	Cs	Cf	Cs	Cf	Cs	Cf	Cs
7.6 m 25'													* 2500	* 2500
6.1 m 20'							* 3360	* 3360					* 2010	* 2010
4.6 m 15'							* 7420	* 7420					* 4430	* 4430
3.0 m 10'							* 3730	* 3730	* 3010	5800			* 1870	* 1870
1.5 m 5'							* 8220	* 8220	* 6650	5800			* 4140	* 4140
0 m 0'							* 6000	* 6000	* 4600	3920	2570		* 1870	* 1870
-1.5 m -5'	* 3920	* 3920	* 9030	6250	6100	3460	* 4390	2370					* 2680	2130
-3.0 m -10'	* 8640	* 8640	* 19920	13780	13440	7640	* 9690	5220					* 5920	4590
-4.6 m -15'	* 7540	* 7540	* 7570	6330	5240	3480							* 3790	2620
	* 16620	* 16620	* 16700	13950	* 11570	7690							* 8350	5790

*Load is limited by hydraulic capacity rather than tipping. Ratings are based on ISO standard No. 10567. Rated loads do not exceed 87% of hydraulic lift capacity or 75% of tipping load.



LIFTING CAPACITY WITH LIFTING MODE

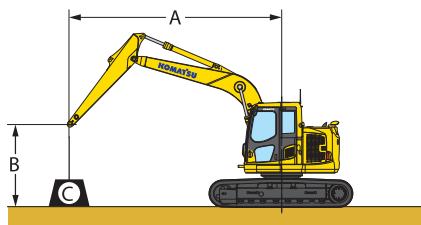

- A: Reach from swing center
- B: Bucket hook height
- C: Lifting capacity
- Cf: Rating over front
- Cs: Rating over side
- ⊗: Rating at maximum reach

- Conditions :
- 4600 mm 15' 1" one-piece boom
 - Counterweight (Standard): 3550 kg 7,826 lb
 - Bucket: None
 - Lifting mode: On
 - No blade

Arm: 3000 mm 9'10"

Shoes: 500 mm 20"

Unit: kg lb

B \ A	1.5 m 5'		3.0 m 10'		4.6 m 15'		6.1 m 20'		7.6 m 25'		⊗ MAX	
	Cf	Cs	Cf	Cs	Cf	Cs	Cf	Cs	Cf	Cs	Cf	Cs
7.6 m 25'					* 2060	* 2060					* 1980	* 1980
					* 4550	* 4550					* 4380	* 4380
6.1 m 20'					* 2960	* 2960	* 1860	* 1860			* 1660	* 1660
					* 6520	* 6520	* 4100	* 4100			* 3670	* 3670
4.6 m 15'					* 2990	* 2990	* 2910	2500			* 1560	* 1560
					* 6600	* 6600	* 6420	5510			* 3430	* 3430
3.0 m 10'		* 3850	* 3850	* 3680	* 3680	* 3470	2430	* 1650	* 1650	* 1550	* 1550	
		* 8500	* 8500	* 8110	* 8110	* 7650	5360	* 3640	* 3640	* 3420	* 3420	
1.5 m 5'		* 7590	6440	* 5180	3510	3770	2320	* 2410	1660	* 1620	1610	
		* 16740	14210	* 11420	7740	8320	5120	* 5310	3670	* 3580	3550	
0 m 0'		* 7920	5940	* 5650	3310	3660	2220	* 2300	1620	* 1780	1620	
		* 17460	13100	* 12470	7290	8080	4900	* 5070	3580	* 3940	3570	
-1.5 m -5'	* 3520	* 3520	* 8510	5780	5520	3190	3600	2160		* 2100	1740	
	* 7770	* 7770	* 18760	12750	12180	7050	7940	4770		* 4640	3850	
-3.0 m -10'	* 7130	* 7130	* 8150	5830	* 5490	3190	3610	2170		* 2780	2080	
	* 15710	* 15710	* 17970	12860	* 12120	7040	7950	4790		* 6130	4500	
-4.6 m -15'		* 5710	* 5710	* 3680	3300					* 3190	3070	
		* 12600	* 12600	* 8120	7280					* 7050	6780	

*Load is limited by hydraulic capacity rather than tipping. Ratings are based on ISO standard No. 10567. Rated loads do not exceed 87% of hydraulic lift capacity or 75% of tipping load.

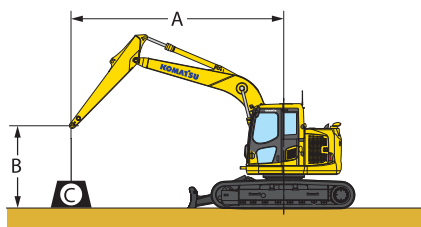

- A: Reach from swing center
- B: Bucket hook height
- C: Lifting capacity
- Cf: Rating over front
- Cs: Rating over side
- ⊗: Rating at maximum reach

- Conditions :
- 4600 mm 15' 1" one-piece boom
 - Counterweight (Standard): 3550 kg 7,826 lb
 - Bucket: None
 - Lifting mode: On
 - Blade included

Arm: 3000 mm 9'10"

Shoes: 500 mm 20"

Unit: kg lb

B \ A	1.5 m 5'		3.0 m 10'		4.6 m 15'		6.1 m 20'		7.6 m 25'		⊗ MAX	
	Cf	Cs	Cf	Cs	Cf	Cs	Cf	Cs	Cf	Cs	Cf	Cs
7.6 m 25'					* 2060	* 2060					* 1980	* 1980
					* 4550	* 4550					* 4380	* 4380
6.1 m 20'					* 2960	* 2960	* 1860	* 1860			* 1660	* 1660
					* 6520	* 6520	* 4100	* 4100			* 3670	* 3670
4.6 m 15'					* 2990	* 2990	* 2910	2630			* 1560	* 1560
					* 6600	* 6600	* 6420	5810			* 3430	* 3430
3.0 m 10'		* 3850	* 3850	* 3680	* 3680	* 3470	2560	* 1650	* 1650	* 1550	* 1550	
		* 8500	* 8500	* 8110	* 8110	* 7650	5660	* 3640	* 3640	* 3420	* 3420	
1.5 m 5'		* 7590	* 6780	* 5180	3700	* 4070	2460	* 2410	1770	* 1620	* 1620	
		* 16740	* 14950	* 11420	8170	* 8980	5420	* 5310	3900	* 3580	* 3580	
0 m 0'		* 7920	6280	* 5940	3500	* 4420	2360	* 2300	1730	* 1780	1720	
		* 17460	13850	* 13110	7720	* 9740	5200	* 5070	3810	* 3940	3800	
-1.5 m -5'	* 3520	* 3520	* 8510	6130	* 6070	3390	* 4430	2300		* 2100	1860	
	* 7770	* 7770	* 18760	13510	* 13400	7480	* 9770	5070		* 4640	4100	
-3.0 m -10'	* 7130	* 7130	* 8150	6170	* 5540	3380	* 3770	2310		* 2780	2210	
	* 15710	* 15710	* 17970	13610	* 12220	7460	* 8320	5090		* 6130	4880	
-4.6 m -15'		* 5710	* 5710	* 3680	* 3460					* 3190	* 3190	
		* 12600	* 12600	* 8120	7640					* 7050	* 7050	

*Load is limited by hydraulic capacity rather than tipping. Ratings are based on ISO standard No. 10567. Rated loads do not exceed 87% of hydraulic lift capacity or 75% of tipping load.

LIFT CAPACITIES



LIFTING CAPACITY WITH LIFTING MODE

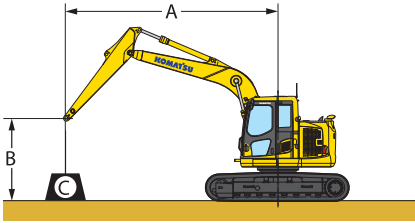

- A: Reach from swing center
- B: Bucket hook height
- C: Lifting capacity
- Cf: Rating over front
- Cs: Rating over side
- ⊗ : Rating at maximum reach

- Conditions :
- 4600 mm 15' 1" one-piece boom
 - Counterweight (Standard): 3550 kg 7,826 lb
 - Bucket: None
 - Lifting mode: On
 - No blade

Arm: 2500 mm 8'2" Shoes: 600 mm 24" Unit: kg lb

B	A		1.5 m 5'		3.0 m 10'		4.6 m 15'		6.1 m 20'		7.6 m 25'		⊗ MAX	
	Cf	Cs	Cf	Cs	Cf	Cs	Cf	Cs	Cf	Cs	Cf	Cs	Cf	Cs
7.6 m 25'													* 2500	* 2500
6.1 m 20'					* 3360	* 3360							* 2010	* 2010
4.6 m 15'					* 7420	* 7420							* 4430	* 4430
3.0 m 10'					* 3730	* 3730	* 3010	* 2520					* 1870	* 1870
1.5 m 5'					* 8220	* 8220	* 6650	* 5560					* 4140	* 4140
0 m 0'			* 6000	* 6000	* 4600	* 3770	* 3940	* 2470					* 1870	* 1870
-1.5 m -5'	* 8460	* 6410	* 13230	* 13230	* 10150	* 8320	* 8690	* 5440					* 4140	* 4140
-3.0 m -10'	* 18660	* 14130	* 12290	* 7840	* 8470	* 5250							* 1980	* 1840
-4.6 m -15'	* 6040	* 6040	* 6040	* 6040	* 5750	* 3390	* 3750	* 2300					* 4370	* 4060
			* 13320	* 14850	* 12690	* 7470	* 8270	* 5070					* 2210	* 1860
	* 3920	* 3920	* 9030	5980	5660	3310	3710	2260					* 2680	2030
	* 8640	* 8640	* 19920	* 13190	* 12490	* 7300	* 8180	* 4990					* 5920	* 4480
	* 7540	* 7540	* 7570	6060	* 5240	3330							* 3790	2510
	* 16620	* 16620	* 16700	* 13360	* 11570	* 7350							* 8350	* 5530

*Load is limited by hydraulic capacity rather than tipping. Ratings are based on ISO standard No. 10567. Rated loads do not exceed 87% of hydraulic lift capacity or 75% of tipping load.

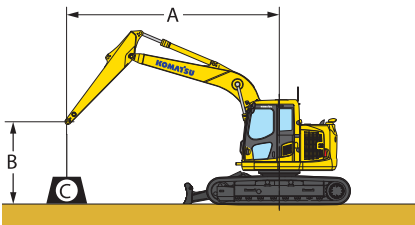

- A: Reach from swing center
- B: Bucket hook height
- C: Lifting capacity
- Cf: Rating over front
- Cs: Rating over side
- ⊗ : Rating at maximum reach

- Conditions :
- 4600 mm 15' 1" one-piece boom
 - Counterweight (Standard): 3550 kg 7,826 lb
 - Bucket: None
 - Lifting mode: On
 - Blade included

Arm: 2500 mm 8'2" Shoes: 600 mm 24" Unit: kg lb

B	A		1.5 m 5'		3.0 m 10'		4.6 m 15'		6.1 m 20'		7.6 m 25'		⊗ MAX	
	Cf	Cs	Cf	Cs	Cf	Cs	Cf	Cs	Cf	Cs	Cf	Cs	Cf	Cs
7.6 m 25'													* 2500	* 2500
6.1 m 20'					* 3360	* 3360							* 2010	* 2010
4.6 m 15'					* 7420	* 7420							* 4430	* 4430
3.0 m 10'					* 3730	* 3730	* 3010	2650					* 1870	* 1870
1.5 m 5'					* 8220	* 8220	* 6650	* 5860					* 4140	* 4140
0 m 0'			* 6000	* 6000	* 4600	* 3970	* 3950	* 2600					* 1870	* 1870
-1.5 m -5'	* 8460	* 6750	* 13230	* 13230	* 10150	* 8750	* 8710	* 5740					* 4140	* 4140
-3.0 m -10'	* 18660	* 14890	* 12290	* 8270	* 9520	* 5540							* 1980	* 1950
-4.6 m -15'	* 6730	* 6380	* 6160	* 3580	* 4560	* 2430							* 4370	* 4300
			* 14850	* 14070	* 13580	* 7900	* 10050	* 5370					* 2210	* 1970
	* 3920	* 3920	* 9030	6320	6100	3500	* 4390	2390					* 2680	2150
	* 8640	* 8640	* 19920	* 13940	* 13440	* 7730	* 9590	* 5280					* 5920	* 4750
	* 7540	* 7540	* 7570	* 6400	* 5240	3520							* 3790	2650
	* 16620	* 16620	* 16700	* 14110	* 11570	* 7780							* 8350	* 5860

*Load is limited by hydraulic capacity rather than tipping. Ratings are based on ISO standard No. 10567. Rated loads do not exceed 87% of hydraulic lift capacity or 75% of tipping load.



LIFTING CAPACITY WITH LIFTING MODE

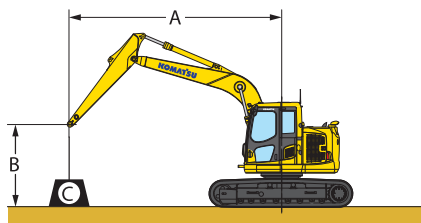

- A: Reach from swing center
- B: Bucket hook height
- C: Lifting capacity
- Cf: Rating over front
- Cs: Rating over side
- ⊗: Rating at maximum reach

- Conditions :
- 4600 mm 15' 1" one-piece boom
 - Counterweight (Standard): 3550 kg 7,826 lb
 - Bucket: None
 - Lifting mode: On
 - No blade

Arm: 3000 mm 9'10"

Shoes: 600 mm 24"

Unit: kg lb

B	A		1.5 m 5'		3.0 m 10'		4.6 m 15'		6.1 m 20'		7.6 m 25'		⊗ MAX	
	Cf	Cs	Cf	Cs	Cf	Cs	Cf	Cs	Cf	Cs	Cf	Cs	Cf	Cs
7.6 m 25'					* 2060	* 2060							* 1980	* 1980
					* 4550	* 4550							* 4380	* 4380
6.1 m 20'					* 2960	* 2960	* 1860	* 1860					* 1660	* 1660
					* 6520	* 6520	* 4100	* 4100					* 3670	* 3670
4.6 m 15'					* 2990	* 2990	* 2910	2530					* 1560	* 1560
					* 6600	* 6600	* 6420	5580					* 3430	* 3430
3.0 m 10'			* 3850	* 3850	* 3680	* 3680	* 3470	2460	* 1650	* 1650			* 1550	* 1550
			* 8500	* 8500	* 8110	* 8110	* 7650	5420	* 3640	* 3640			* 3420	* 3420
1.5 m 5'			* -7590	6510	* 5180	3550	3820	2350	* 2410	1680			* 1620	* 1620
			* 16740	14360	* 11420	7830	8420	5190	* 5310	3720			* 3580	* 3580
0 m 0'			* 7920	6010	5720	3350	3710	2250	* 2300	1640			* 1780	1640
			* 17460	13260	12620	7380	8180	4970	* 5070	3630			* 3940	3620
-1.5 m -5'	* 3520	* 3520	* 8510	5850	5590	3240	3640	2190					* 2100	1770
	* 7770	* 7770	* 18760	12910	12330	7140	8040	4840					* 4640	3900
-3.0 m -10'	* 7130	* 7130	* 8150	5900	5540	3230	3650	2200					* 2780	2110
	* 15710	* 15710	* 17970	13010	* 12220	7130	8050	4850					* 6130	4660
-4.6 m -15'			* 5710	* 5710	* 3680	3340							* 3190	3110
			* 12600	* 12600	* 8120	7370							* 7050	6860

*Load is limited by hydraulic capacity rather than tipping. Ratings are based on ISO standard No. 10567. Rated loads do not exceed 87% of hydraulic lift capacity or 75% of tipping load.

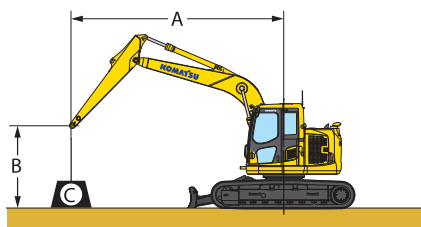

- A: Reach from swing center
- B: Bucket hook height
- C: Lifting capacity
- Cf: Rating over front
- Cs: Rating over side
- ⊗: Rating at maximum reach

- Conditions :
- 4600 mm 15' 1" one-piece boom
 - Counterweight (Standard): 3550 kg 7,826 lb
 - Bucket: None
 - Lifting mode: On
 - Blade included

Arm: 3000 mm 9'10"

Shoes: 600 mm 24"

Unit: kg lb

B	A		1.5 m 5'		3.0 m 10'		4.6 m 15'		6.1 m 20'		7.6 m 25'		⊗ MAX	
	Cf	Cs	Cf	Cs	Cf	Cs	Cf	Cs	Cf	Cs	Cf	Cs	Cf	Cs
7.6 m 25'					* 2060	* 2060							* 1980	* 1980
					* 4550	* 4550							* 4380	* 4380
6.1 m 20'					* 2960	* 2960	* 1860	* 1860					* 1660	* 1660
					* 6520	* 6520	* 4100	* 4100					* 3670	* 3670
4.6 m 15'					* 2990	* 2990	* 2910	2660					* 1560	* 1560
					* 6600	* 6600	* 6420	5870					* 3430	* 3430
3.0 m 10'			* 3850	* 3850	* 3680	* 3680	* 3470	2590	* 1650	* 1650			* 1550	* 1550
			* 8500	* 8500	* 8110	* 8110	* 7650	5720	* 3640	* 3640			* 3420	* 3420
1.5 m 5'			* 7590	6860	* 5180	3740	* 4070	2480	* 2410	1790			* 1620	* 1620
			* 16720	15120	* 11420	8260	* 8980	5480	* 5310	3950			* 3580	* 3580
0 m 0'			* 7920	6350	* 5940	3540	* 4420	2390	* 2300	1750			* 1780	1740
			* 17460	14010	* 13110	7810	* 9740	5260	* 5070	3860			* 3940	3850
-1.5 m -5'	* 3520	* 3520	* 8510	6200	* 6070	3430	* 4430	2330					* 2100	1880
	* 7770	* 7770	* 18760	13670	* 13400	7570	* 9770	5140					* 4640	4150
-3.0 m -10'			* 5710	* 5710	* 3680	3500							* 3190	* 3190
			* 12600	* 12600	* 8120	* 7720							* 7050	* 7050
-4.6 m -15'														

*Load is limited by hydraulic capacity rather than tipping. Ratings are based on ISO standard No. 10567. Rated loads do not exceed 87% of hydraulic lift capacity or 75% of tipping load.

LIFT CAPACITIES



LIFTING CAPACITY WITH LIFTING MODE

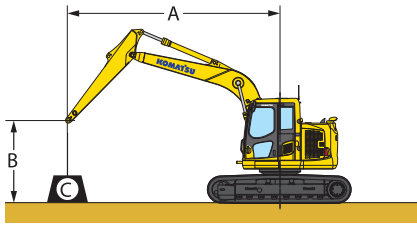

- A: Reach from swing center
- B: Bucket hook height
- C: Lifting capacity
- Cf: Rating over front
- Cs: Rating over side
- ⊗ : Rating at maximum reach

- Conditions :
- 4600 mm 15' 1" one-piece boom
 - Counterweight (Standard): 3550 kg 7,826 lb
 - Bucket: None
 - Lifting mode: On
 - No blade

Arm: 2500 mm 8'2" Shoes: 700 mm 28" Unit: kg lb

B	A		1.5 m 5'		3.0 m 10'		4.6 m 15'		6.1 m 20'		7.6 m 25'		⊗ MAX	
	Cf	Cs	Cf	Cs	Cf	Cs	Cf	Cs	Cf	Cs	Cf	Cs	Cf	Cs
7.6 m 25'													* 2500	* 2500
6.1 m 20'							* 3360	* 3360					* 5510	* 5510
4.6 m 15'							* 7420	* 7420					* 2010	* 2010
3.0 m 10'							* 3730	* 3730	* 3010	2550			* 1870	* 1870
1.5 m 5'							* 8220	* 8220	* 6650	5630			* 4140	* 4140
0 m 0'							* 6000	* 6000	* 4600	3820	* 3950	2500	* 1870	* 1870
-1.5 m -5'	* 3920	* 3920	* 9030	6060	5740	3360	3760	2290					* 2680	2060
-3.0 m -10'	* 8640	* 8640	* 19920	13360	12660	7400	8290	5050					* 5290	4540
-4.6 m -15'	* 7540	* 7540	* 7570	6140	5240	3380							* 3790	2540
	* 16620	* 16620	* 16700	13530	11570	7450							* 8350	5610

*Load is limited by hydraulic capacity rather than tipping. Ratings are based on ISO standard No. 10567. Rated loads do not exceed 87% of hydraulic lift capacity or 75% of tipping load.

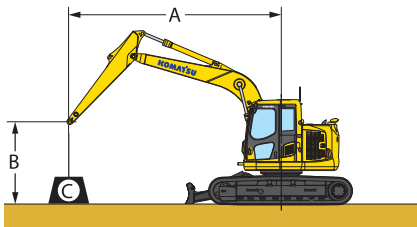

- A: Reach from swing center
- B: Bucket hook height
- C: Lifting capacity
- Cf: Rating over front
- Cs: Rating over side
- ⊗ : Rating at maximum reach

- Conditions :
- 4600 mm 15' 1" one-piece boom
 - Counterweight (Standard): 3550 kg 7,826 lb
 - Bucket: None
 - Lifting mode: On
 - Blade included

Arm: 2500 mm 8'2" Shoes: 700 mm 28" Unit: kg lb

B	A		1.5 m 5'		3.0 m 10'		4.6 m 15'		6.1 m 20'		7.6 m 25'		⊗ MAX	
	Cf	Cs	Cf	Cs	Cf	Cs	Cf	Cs	Cf	Cs	Cf	Cs	Cf	Cs
7.6 m 25'													* 2500	* 2500
6.1 m 20'							* 3360	* 3360					* 5510	* 5510
4.6 m 15'							* 7420	* 7420					* 2010	* 2010
3.0 m 10'							* 3730	* 3730	* 3010	2690			* 1870	* 1870
1.5 m 5'							* 8220	* 8220	* 6650	5930			* 4140	* 4140
0 m 0'							* 6000	* 6000	* 4600	4010	* 3950	2630	* 1870	* 1870
-1.5 m -5'	* 3920	* 3920	* 9030	6400	6100	3550	4390	2430					* 2680	2180
-3.0 m -10'	* 8640	* 8640	* 19920	14120	13440	7830	9590	5350					* 5920	4810
-4.6 m -15'	* 7540	* 7540	* 7570	6480	5240	3570							* 3790	2690
	* 16620	* 16620	* 16700	14290	11570	7880							* 8350	5930

*Load is limited by hydraulic capacity rather than tipping. Ratings are based on ISO standard No. 10567. Rated loads do not exceed 87% of hydraulic lift capacity or 75% of tipping load.



LIFTING CAPACITY WITH LIFTING MODE

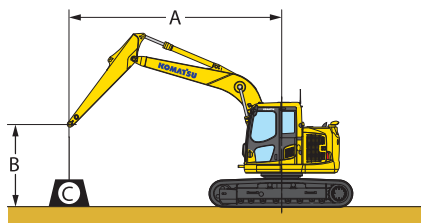

- A: Reach from swing center
- B: Bucket hook height
- C: Lifting capacity
- Cf: Rating over front
- Cs: Rating over side
- ⊗: Rating at maximum reach

- Conditions :
- 4600 mm 15' 1" one-piece boom
 - Counterweight (Standard): 3550 kg 7,826 lb
 - Bucket: None
 - Lifting mode: On
 - No blade

Arm: 3000 mm 9'10"

Shoes: 700 mm 28"

Unit: kg lb

B \ A	1.5 m 5'		3.0 m 10'		4.6 m 15'		6.1 m 20'		7.6 m 25'		⊗ MAX	
	Cf	Cs	Cf	Cs	Cf	Cs	Cf	Cs	Cf	Cs	Cf	Cs
7.6 m 25'					* 2060	* 2060					* 1980	* 1980
					* 4550	* 4550					* 4380	* 4380
6.1 m 20'					* 2960	* 2960	* 1860	* 1860			* 1660	* 1660
					* 6520	* 6520	* 4100	* 4100			* 3670	* 3670
4.6 m 15'					* 2990	* 2990	* 2910	2560			* 1560	* 1560
					* 6600	* 6600	* 6420	5650			* 3430	* 3430
3.0 m 10'			* 3850	* 3850	* 3680	* 3680	* 3470	2490	* 1650	* 1650	* 1550	* 1550
			* 8500	* 8500	* 8110	* 8110	* 7650	5490	* 3640	* 3640	* 3420	* 3420
1.5 m 5'			* 7590	6590	* 5180	3590	3870	2380	* 2410	1710	* 1620	* 1620
			* 16740	14450	* 11420	7930	8540	5250	* 5310	3770	* 3580	* 3580
0 m 0'			* 7920	6090	5800	3390	3760	2280	* 2300	1670	* 1780	1660
			* 17460	13430	12790	7480	8290	5030	* 5070	3680	* 3940	3670
-1.5 m -5'	* 3520	* 3520	* 8510	5930	5670	3280	3690	2220			* 2100	1790
	* 7770	* 7770	* 18760	13090	12500	7240	8150	4910			* 4640	3960
-3.0 m -10'	* 7130	* 7130	* 8150	5980	* 5540	3270	3700	2230			* 2780	2140
	* 15710	* 15710	* 17970	13190	* 12220	7230	8170	4920			* 6130	4720
-4.6 m -15'			* 5710	* 5710	* 3680	3380					* 3190	3150
			* 12600	* 12600	* 8120	7470					* 7050	6960

*Load is limited by hydraulic capacity rather than tipping. Ratings are based on ISO standard No. 10567. Rated loads do not exceed 87% of hydraulic lift capacity or 75% of tipping load.

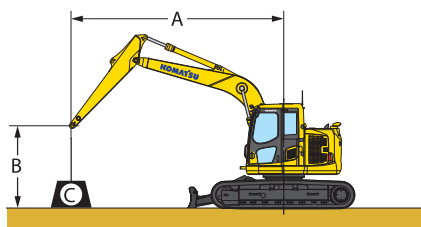

- A: Reach from swing center
- B: Bucket hook height
- C: Lifting capacity
- Cf: Rating over front
- Cs: Rating over side
- ⊗: Rating at maximum reach

- Conditions :
- 4600 mm 15' 1" one-piece boom
 - Counterweight (Standard): 3550 kg 7,826 lb
 - Bucket: None
 - Lifting mode: On
 - Blade included

Arm: 3000 mm 9'10"

Shoes: 700 mm 28"

Unit: kg lb

B \ A	1.5 m 5'		3.0 m 10'		4.6 m 15'		6.1 m 20'		7.6 m 25'		⊗ MAX	
	Cf	Cs	Cf	Cs	Cf	Cs	Cf	Cs	Cf	Cs	Cf	Cs
7.6 m 25'					* 2060	* 2060					* 1980	* 1980
					* 4550	* 4550					* 4380	* 4380
6.1 m 20'					* 2960	* 2960	* 1860	* 1860			* 1660	* 1660
					* 6520	* 6520	* 4100	* 4100			* 3670	* 3670
4.6 m 15'					* 2990	* 2990	* 2910	2690			* 1560	* 1560
					* 6600	* 6600	* 6420	5940			* 3430	* 3430
3.0 m 10'			* 3850	* 3850	* 3680	* 3680	* 3470	2620	* 1650	* 1650	* 1550	* 1550
			* 8500	* 8500	* 8110	* 8110	* 7650	5790	* 3640	* 3640	* 3420	* 3420
1.5 m 5'			* 7590	6940	* 5180	3790	* 4070	2520	* 2410	1810	* 1620	* 1620
			* 16740	15300	* 11420	8360	* 8980	5550	* 5310	4000	* 3580	* 3580
0 m 0'			* 7920	6430	* 5940	3590	* 4420	2420	* 2300	1770	* 1780	1770
			* 17460	14190	* 13110	7910	* 9740	5330	* 5070	3910	* 3940	3900
-1.5 m -5'	* 3520	* 3520	* 8510	6280	* 6070	3470	* 4430	2360			* 2100	1910
	* 7770	* 7770	* 18760	13840	* 13400	7670	* 9770	5200			* 4640	4210
-3.0 m -10'	* 7130	* 7130	* 8150	6320	* 5540	3470	* 3770	2370			* 2780	2270
	* 15710	* 15710	* 17970	13940	* 12220	7650	* 8320	5220			* 6130	5010
-4.6 m -15'			* 5710	* 5710	* 3680	* 3550					* 3190	* 3190
			* 12600	* 12600	* 8120	7820					* 7050	* 7050

*Load is limited by hydraulic capacity rather than tipping. Ratings are based on ISO standard No. 10567. Rated loads do not exceed 87% of hydraulic lift capacity or 75% of tipping load.



STANDARD EQUIPMENT

- Alternator, 35 Ampere, 24V
- AM/FM radio
- Automatic engine warm-up system
- Automatic air conditioner/heater
- Auxiliary input (3.5 mm jack)
- Batteries, large capacity
- Battery disconnect switch
- Boom holding valve
- Converter, (2) x 12V
- Counterweight, 3550 kg **7,826 lb**
- Dry type air cleaner, double element
- Electric horn
- EMMS monitoring system
- Engine, Komatsu SAA4D95LE-6
- Engine overheat prevention system
- Extended work equipment grease interval
- Fan guard structure
- Fuel system pre-cleaner 10 micron
- Hydraulic track adjusters
- KOMTRAX® Level 4.0
- Large LCD color monitor, high resolution
- Lock lever
- Mirrors, (LH and RH)
- Operator Protective Top Guard (OPG), Level 1 (ISO 10262)
- Pattern change valve (ISO to BH control)
- PPC hydraulic control system
- Provision for blade
- Pump/engine room partition cover
- Radiator and oil cooler dustproof net
- Rear reflectors
- Rearview monitoring system (1 camera)
- Revolving frame undercovers
- ROPS cab (ISO 12117-2)
- Seat belt, retractable, 76 mm **3"**
- Seat belt indicator
- Secondary engine shutoff switch
- Service valve
- Shoes, triple grouser, 600 mm **24"**
- Skylight
- Slip resistant foot plates
- Starter motor, 4.5kW
- Suction fan
- Thermal and fan guards
- Track frame undercover
- Travel alarm
- Working lights, 1 cab LH side/1 boom LH
- Working mode selection system



OPTIONAL EQUIPMENT

- 2690 mm **8'6"** dozer blade with wide cutting edge
- Additional track frame step
- Arms
 - 3000 mm **9'10"** arm assembly
- Cab guards
 - Full front guard, OPG Level 1
 - Full front guard, OPG Level 2
 - Bolt-on top guard, OPG Level 2
- Hydraulic control unit, 1 actuator
- Shoes, triple grouser, 500 mm **20"**
- Shoes, triple grouser, 700 mm **28"**
- Sun visor
- Working light, front, one additional



ATTACHMENT OPTIONS

- Hydraulic couplers
- Hydraulic kits, field installed

For a complete list of available attachments, please contact your local Komatsu distributor.

