

KOMATSU®

PC300-8M0 PC300LC-8M0

PC
300

HORSEPOWER

Gross: 194 kW 260 HP / 1950 min⁻¹

Net: 187 kW 250 HP / 1950 min⁻¹

OPERATING WEIGHT

PC300-8M0: 31100 – 32010 kg

PC300LC-8M0: 31600 – 32580 kg

BUCKET CAPACITY

0.52 – 1.80 m³



Photos may include optional equipment.

Courtesy of Machine.Market

WALK-AROUND





PRODUCTIVITY, ECOLOGY & ECONOMY

- High Production and Low Fuel Consumption by Total Control of the Engine, Hydraulic and Electronic System
- Low Emission Engine and Low Operation Noise
- Large Drawbar Pull and Digging Force
- Two-mode Setting for Boom

COMFORT & SAFETY

- Large Comfortable Cab
- ROPS Cab (ISO 12117-2)
- Rear View Monitor System (Optional)

* Information and Communication Technology

ICT* & KOMTRAX

- Large Multi-lingual High Resolution Liquid Crystal Display (LCD) Monitor
- Equipment Management Monitoring System
- KOMTRAX

MAINTENANCE & RELIABILITY

- Easy Maintenance
- High Rigidity Work Equipment



	PC300-8M0	PC300LC-8M0
HORSEPOWER	Gross: 194 kW 260 HP / 1950 min ⁻¹ Net: 187 kW 250 HP / 1950 min ⁻¹	194 kW 260 HP / 1950 min ⁻¹ 187 kW 250 HP / 1950 min ⁻¹
OPERATING WEIGHT	31100 – 32010 kg	31600 – 32580 kg
BUCKET CAPACITY	0.52 – 1.80 m ³	0.52 – 1.80 m ³

PRODUCTIVITY, ECOLOGY & ECONOMY

Low Fuel Consumption

The newly-developed Komatsu SAA6D114E-3 engine enables NOx emissions to be significantly reduced with the accurate multi-staged fuel injection by the engine controller. It improves total engine durability using the high-pressure fuel injection system developed specifically for construction machinery. This excavator significantly reduces hourly fuel consumption using the highly-efficient matching techniques of the engine and hydraulic unit and also provides features that promote energy-saving operations such as the E mode and ECO gauge.

Fuel consumption

3% reduced

Vs. PC300-8
Based on typical work pattern collected via KOMTRAX.
Fuel consumption varies depending on job conditions.

Komatsu Technology

Komatsu develops and produces all major components, such as engines, electronics and hydraulic components, in house. With this “Komatsu Technology” and adding customer feedback, Komatsu is achieving great advancements in technology. To achieve both high levels of productivity and economical performance, Komatsu has developed the main components with a total control system. The result is a new generation of high performance and environment-friendly excavators.

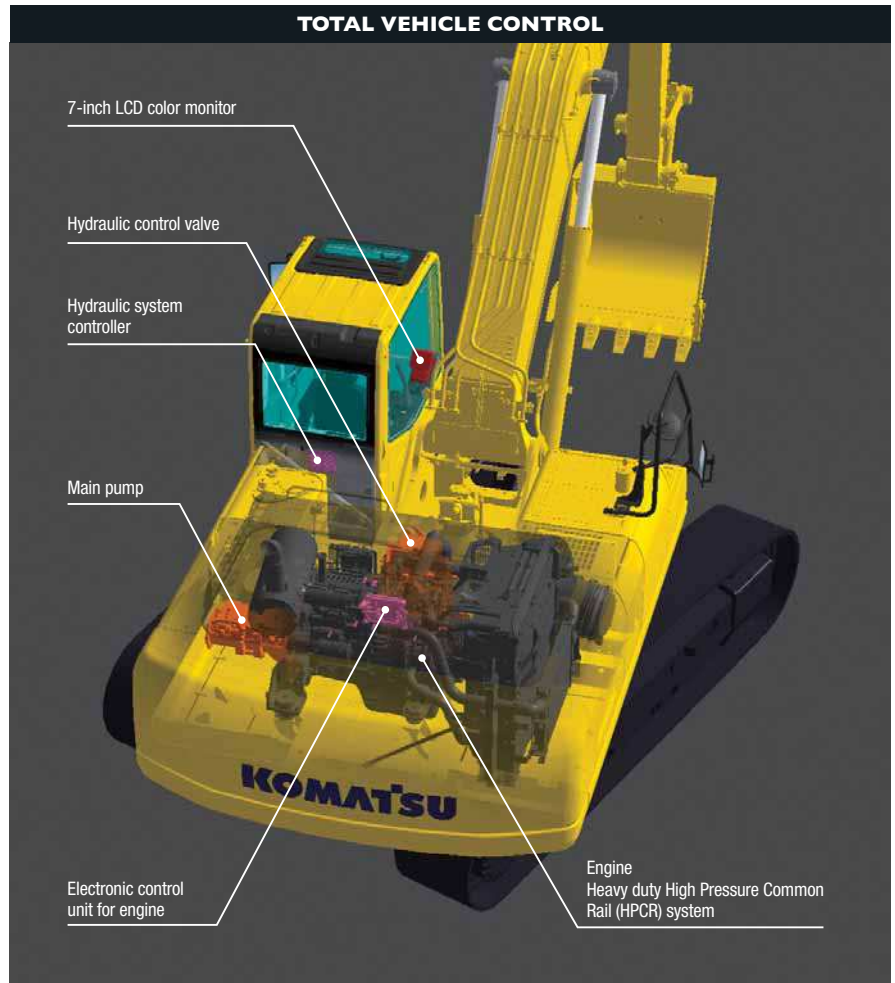

Low Emission Engine

Komatsu SAA6D114E-3 reduced NOx emission by 33% compared with the PC300-7. This engine is U.S. EPA Tier 3 and EU Stage 3A emissions equivalent.

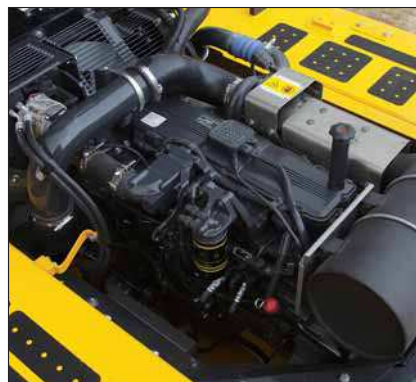

Low Operation Noise

Enables a low noise operation using the low-noise engine and methods to cut noise at source.

Idling Caution

To prevent unnecessary fuel consumption, an idling caution is displayed on the monitor, if the engine idles for 5 minutes or more.



ECO Gauge that Assists Energy-saving Operations

Equipped with the ECO gauge that can be recognized at a glance on the right of the multi-function color monitor for environment-friendly energy-saving operations. Allows focus on operation in the green range with reduced CO₂ emissions and efficient fuel consumption.



ECO gauge

Working Modes Selectable

The PC300-8M0 excavator is equipped with six working modes (P, E, L, B, ATT/P and ATT/E mode). Each mode is designed to match engine speed and pump output to the application. This provides the flexibility to match equipment performance to the job at hand.



Working Mode	Application	Advantage
P	Power mode	<ul style="list-style-type: none"> • Maximum production/power • Fast cycle times
E	Economy mode	<ul style="list-style-type: none"> • Good cycle times • Better fuel economy
L	Lifting mode	<ul style="list-style-type: none"> • Suitable attachment speed • Lifting capacity is increased 7% by raising hydraulic pressure.
B	Breaker mode	<ul style="list-style-type: none"> • Optimum engine rpm, hydraulic flow
ATT/P	Attachment Power mode	<ul style="list-style-type: none"> • Optimum engine rpm, hydraulic flow, 2 way • Power mode
ATT/E	Attachment Economy mode	<ul style="list-style-type: none"> • Optimum engine rpm, hydraulic flow, 2 way • Economy mode

Larger Maximum Drawbar Pull

Larger maximum drawbar pull provides superb steering and slope climbing performance.

Maximum drawbar pull:
264 kN (26900 kg)



Large Digging Force

When press the left knob switch which is called the one-touch power max. switch and when it is kept pressed, this function temporarily increases digging force for 8.5 seconds of operation.

Maximum arm crowd force (ISO 6015):
160 kN (16.3 t) ➔ **171 kN (17.4 t)** **7% UP**
(With Power Max.)

Maximum bucket digging force (ISO 6015):
212 kN (21.6 t) ➔ **227 kN (23.1 t)** **7% UP**
(With Power Max.)

Measured with Power Max. function, 3185 mm arm and ISO 6015 rating.



One-touch power max. switch

Smooth Loading Operation

Two return hoses improve hydraulic performance. In the arm out function, a portion of the oil is returned directly to the tank providing smooth operation.



Two-mode Setting for Boom

Smooth mode provides easy operation for gathering blasted rock or scraping down operation. When maximum digging force is needed, switch to Power mode for more effective excavating.

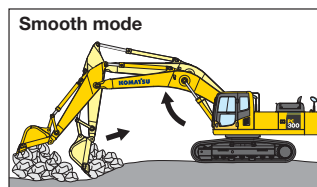

Boom floats upward, reducing lifting of machine front. This facilitates gathering blasted rock and scraping down operations.

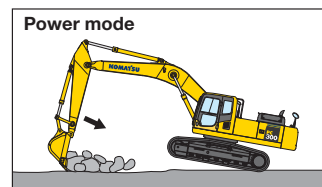

Boom pushing force is increased, ditch digging and box digging operation on hard ground are improved.

COMFORT



Low Cab Noise

The newly-designed cab is highly rigid and has excellent sound absorption ability. Thorough improvement of noise source reduction and use of low noise engine, hydraulic equipment, and air conditioner allows this machine to generate a low level of noise.

Low Vibration with Cab Damper Mounting

PC300-8M0 uses viscous damper mounting for cab that incorporates longer stroke and the addition of a spring. The new cab damper mounting combined with high rigidity deck aids vibration reduction at operator seat.

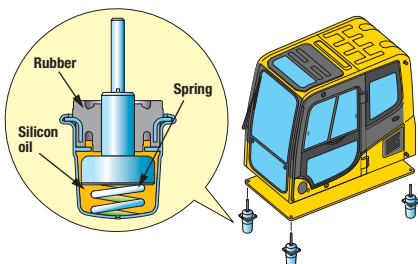

Wide Newly-designed Cab

Newly-designed wide spacious cab includes seat with reclining backrest. The seat height and longitudinal inclination are easily adjusted using a pull-up lever. You can set the appropriate operational posture of armrest together with the console. Reclining the seat further enables you to place it into the fully flat state with the headrest attached.



Pressurized Cab

Optional air conditioner (A/C), air filter and a higher internal air pressure minimize external dust from entering the cab.

Automatic Air Conditioner (A/C)

Enables you to easily and precisely set cab atmosphere with the instruments on the large LCD. The bi-level control function keeps the operator's head and feet cool and warm respectively. This improved air flow function keeps the inside of the cab comfortable throughout the year. Defroster function keeps front glass clear.

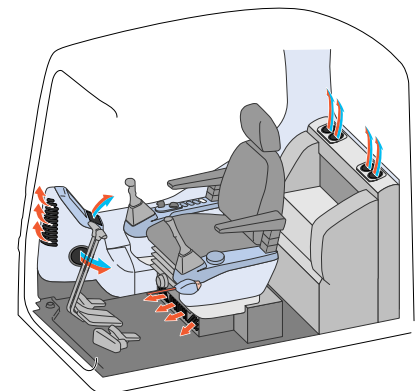

SAFETY

ROPS Cab

The machine is equipped with a ROPS cab that conforms to ISO 12117-2 for excavators as standard equipment. The ROPS cab has high shock-absorption performance, featuring excellent durability and impact strength. It also satisfies the requirements of OPG top guard level 1 (ISO 10262) for falling objects. Combined with the retractable seat belt, The ROPS cab protects the operator in case of tipping over and against falling objects.

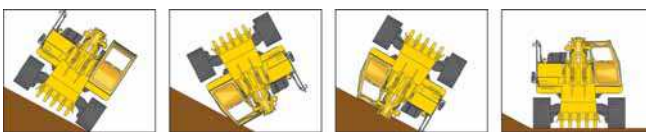
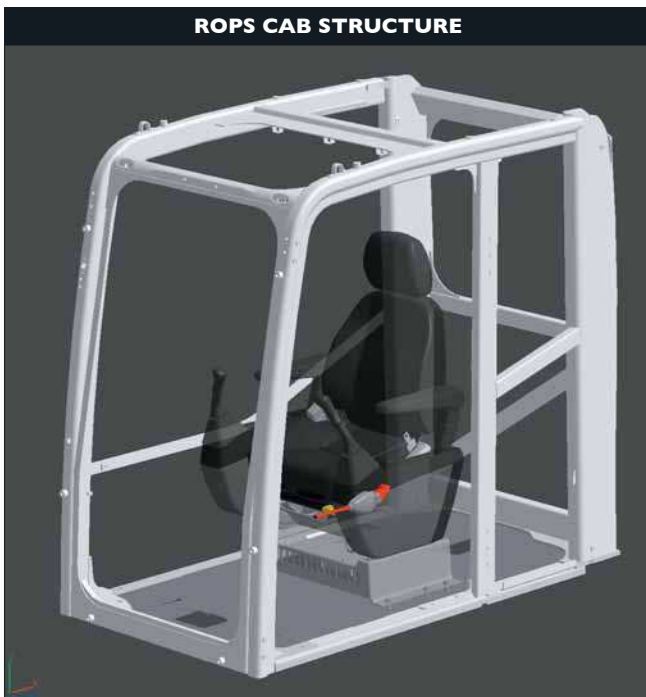

Slip-resistant Plates

Highly durable slip-resistant plates maintain superior traction performance for the long term.



Pump/Engine Room Partition

Pump/engine room partition prevents oil from spraying onto the engine if a hydraulic hose should burst.

Lock Lever

Locks the hydraulic pressure to prevent unintentional movement. Neutral start function allows machine to be started only in lock position.



Large Side-view, Rear and Sidewise Mirrors

Enlarged left-side mirror and addition of rear and side mirror allow the PC300-8M0 to meet the visibility requirements (ISO 5006).



Rear View Monitor System (Optional)

The operator can view the rear of the machine with a color monitor screen.



Rear view image on monitor

Thermal and Fan Guards

Thermal and fan guards are placed around high-temperature parts of the engine and fan drive.





Large Multi-lingual High Resolution LCD Monitor

A large user-friendly high resolution LCD color monitor enables safe, accurate and smooth work. Visibility and resolution are further improved compared with current 7-inch large LCD. Simple and easy to operate switches. Function keys facilitate multi-function operations. Displays data in 13 languages to globally support operators around the world.

Indicators

- | | |
|----------------------------------|-----------------------------------|
| 1 Auto-decelerator | 5 Hydraulic oil temperature gauge |
| 2 Working mode | 6 Fuel gauge |
| 3 Travel speed | 7 ECO gauge |
| 4 Engine water temperature gauge | 8 Fuel consumption gauge |
| | 9 Function switches menu |

Basic operation switches

- | | |
|-------------------------|---------------------|
| 1 Auto-decelerator | 4 Buzzer cancel |
| 2 Working mode selector | 5 Wiper |
| 3 Traveling selector | 6 Windshield washer |

Supports Efficiency Improvement

The main screen displays advices for promoting energy-saving operations as needed. The operator can use the ECO guidance menu to check the operation records, ECO guidance records, average fuel consumption logs, etc.



ECO guidance



ECO guidance menu



ECO guidance records



Operation records



Average fuel consumption logs

Equipment Management Monitoring System

Monitor function

Controller monitors engine oil level, coolant temperature, battery charge air clogging, etc. If the controller finds any abnormality, it is displayed on the LCD.



Maintenance function

The monitor informs replacement time of oil and filters on the LCD when the replacement interval is reached.



Trouble data memory function

Monitor stores abnormalities for effective troubleshooting.



Assists Customer's Equipment Management and Contributes to Fuel Cost Cutting

Equipment Management Support

KOMTRAX terminal installed on your machine collects and sends information such as machine location, working record, machine conditions, etc. using wireless communication. You can review the KOMTRAX data remotely via the online application. KOMTRAX not only gives you the informations on your machine, but also the convenience of managing your fleet on the Web.

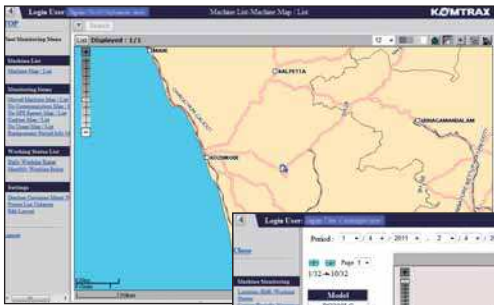

Location

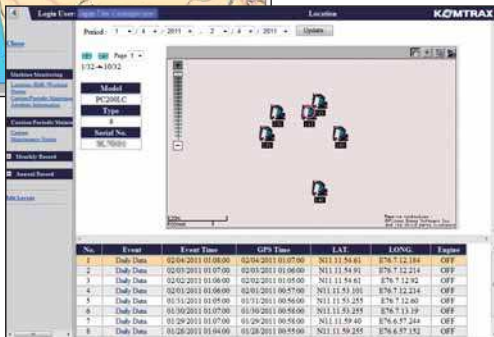

Movement generated position



Operation map

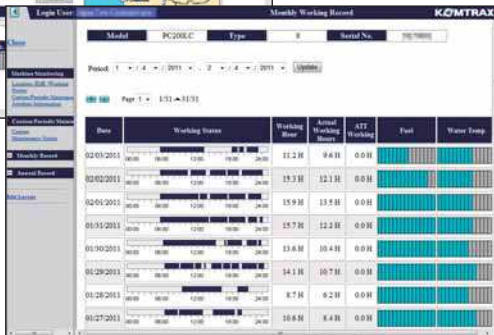

Monthly status summary

Energy-saving Operation Support Report

KOMTRAX can provide various useful information which includes the energy-saving operation support report created based on the operating information of your machine such as fuel consumption and idle time.

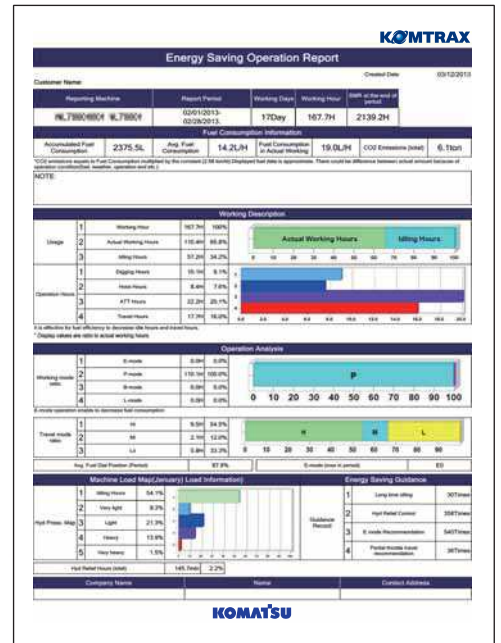

Image



MAINTENANCE

Side-by-side Cooling

Since radiator and oil cooler are arranged in parallel, it is easy to clean, remove and install them.



Equipped with the Drain Valve as Standard

Prevents clothes and the ground from becoming contaminated due to oil leakage when replacing the engine oil.



High-capacity Air Cleaner

High capacity air cleaner is comparable to that of larger machines. The larger air cleaner can extend air cleaner life during long-term operation and prevents early clogging and resulting power decrease. Reliability is improved by a new seal design.



Easy Access to Engine Oil Filter and Fuel Drain Valve

Engine oil level gauge, and fuel filter are one side mounted to improve accessibility. Engine oil filter and fuel drain valve are remotely mounted to improve accessibility.



Engine oil filter



Fuel drain valve

Long Work Equipment Greasing Interval (Optional)

High quality bushings and resin shims are optionally available for work equipment pins excluding bucket, extending greasing interval to 500 hours.

Equipped with the Fuel Pre-filter (With Water Separator)

Removes water and contaminants in the fuel to prevent fuel problems.



Long-life Oil, Filter

Uses high-performance filtering materials and long-life oil. Extends the oil and filter replacement interval.

Engine oil & Engine oil filter	every 500 hours
Hydraulic oil	every 5000 hours
Hydraulic oil filter	every 1000 hours



Large Fuel Tank Capacity

Large fuel tank capacity extends operating hours before refueling. Fuel tank is treated for rust prevention.

RELIABILITY

High Rigidity Work Equipment

Boom and arms are constructed of thick plates of high tensile strength steel. In addition, these structures are designed with large cross-sectional areas and generous use of castings. The result is working attachments that exhibit long term durability and high resistance to bending and torsional stress.

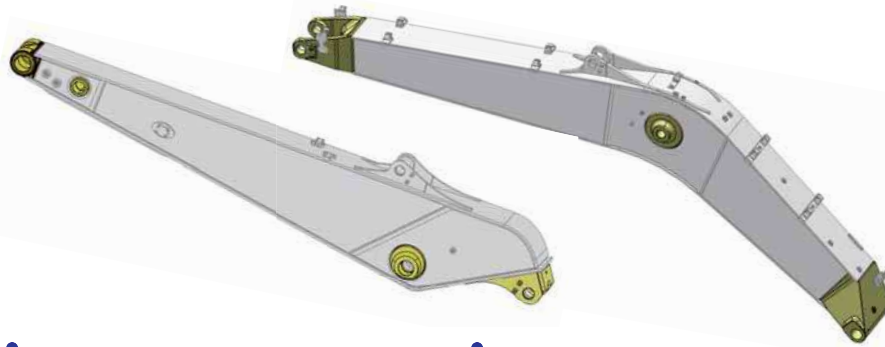

Sturdy Frame Structure

The revolving frame, center frame and undercarriage are designed by using the most advanced three-dimensional CAD and Finite Element Method (FEM) analysis technology.

Highly Reliable Electronic Devices

Exclusively designed electronic devices have passed severe testing.

- Controller
- Sensors
- Connectors
- Heat resistant wiring

Grease Sealed Track

PC300-8M0 uses grease sealed tracks for extended undercarriage life.

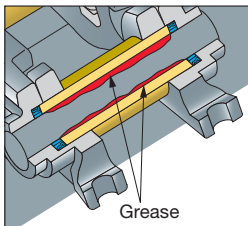

Track Link with Strut

PC300-8M0 uses track links with strut, providing superb durability.



Reliable Components

All of the major machine components, such as engine, hydraulic pumps, hydraulic motors and control valves are exclusively designed and manufactured by Komatsu.

OPTIONS

- Cab front full height guard level 1 (ISO 10262)



- Cab front full height guard level 2 (ISO 10262)



- Additional front lights
- Rain visor



- Air pre-cleaner



- OPG top guard level 2 (ISO 10262)



- Strengthened track frame undercover



- Sun visor



- Seat, suspension



KOMATSU BRAND BUCKET

KOMATSU Brand Bucket for General Purpose with Wide Bucket Width

Me Bucket

- Low resistant excavation
- High productivity
- High durability
- High fuel efficiency



Conventional



Me Bucket

Category and Feature

Category	Load / Wear / Soil (Application)	Image
Light Duty LD	<p>Load Machine power remains low during the majority of the work. No impact load.</p> <p>Wear Material is not abrasive.</p> <p>Soil Dirt, loam and clay.</p>	
General Purpose GP	<p>Load Machine power is mostly medium, but occasionally high. Bucket movements are smooth with minor shock load. Bucket penetrates easily.</p> <p>Wear Material is lightly abrasive. Some sand may be medium abrasive.</p> <p>Soil Mostly loose sand, gravel and finely broken materials.</p>	
Heavy Duty HD	<p>Load Machine power is high during majority of the work. Medium, but continuous shock load.</p> <p>Wear Material is abrasive. Light scratch marks can be seen at the bucket.</p> <p>Soil Limestone, shot rock, compact mix of sand, gravel and clay.</p>	
Extra Heavy Duty XHD	<p>Load Machine power is high during most of the work, often at maximum. Dynamic shock loads are frequent and machine may shake.</p> <p>Wear Material is very abrasive. Large scratch marks are visible and, or deform metal. Works within heaps of rock with occasional un-shot rock and rock boulders.</p> <p>Soil Granite, basalt, quartz sand, compact and sticky clay.</p>	

Bucket Line-up

Category	Bucket Type	Capacity (m ³)	Width* ¹ (mm)	Weight* ² (kg)	Tooth Quantity	Boom + Arm (m)				Tooth Type			
						6.47+2.22	6.47+2.55	6.47+3.19	6.47+4.02	Vertical	Horizontal	PAB* ³	KMAX
LD	Conventional	1.80	— <1700>	940	5	●	●	●	×	✓	✓	✓	✓
		0.52	740 <610>	664	3	○	○	○	○	✓			
		1.14	1275 <1145>	900	5	○	○	○	○	✓	✓	✓	
		1.40	1445 <1340>	1015	5	○	○	○	●	✓	✓	✓	
GP	Conventional	1.60	1645 <1515>	1102	5	□	□	□	×	✓	✓	✓	✓
		1.40	1445 <1340>	1508	5	○	○	○	×		✓	✓	✓
		1.40	1445 <1340>	1430	5	○	○	○	×		✓	✓	✓
HD	Me Bucket	1.60	1645 <1515>	1610	5	□	□	□	×		✓	✓	✓
		1.40	1445 <1340>	1585	5	□	□	□	×		✓	✓	
XHD	Me Bucket	1.60	1645 <1515>	2165	5	□	□	□	×		✓	✓	
		1.40	1445 <1340>		5	□	□	□	×		✓	✓	

*1 With side cutters or side shrouds, < > without side cutters or side shrouds *2 With side cutters *3 PAB: Pin And Bushing system

○: General purpose use, density up to 1.8 t/m³ □: General purpose use, density up to 1.5 t/m³ ●: Light duty work, density up to 1.2 t/m³ ×: Not usable ✓: Selectable

Feature of [Me Bucket] (More suitable shape and Effectiveness Bucket)

High Productivity by Low-resistant Excavation

The new Ideal bucket profile produces lower resistance at inside & outside bucket and production will be greatly increased.

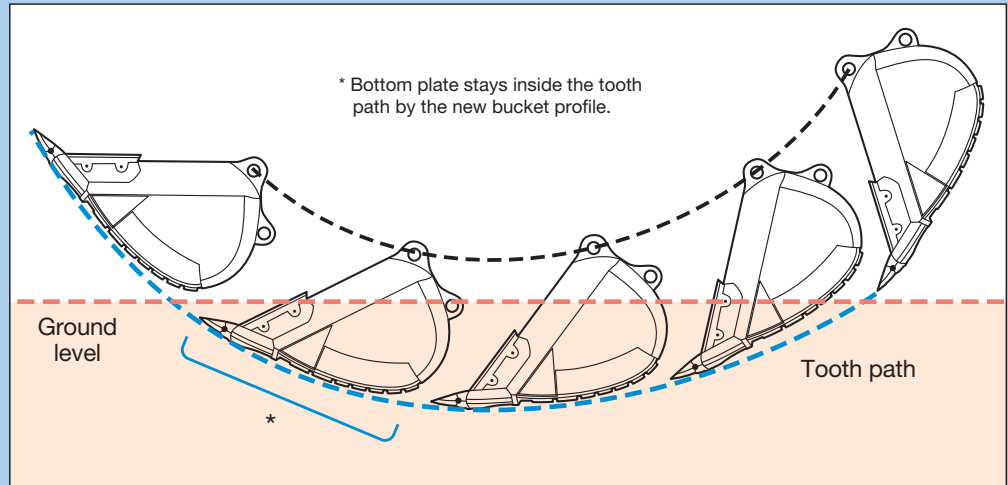

Feature of [PAB Tooth] (Pin And Bushing system Tooth)

- Able to fit on the bucket with horizontal pin type adapter
 - Easy change-out only with a ratchet wrench
 - Longer tooth life by easy rotation and turnover
 - Durable and reusable PAB pin with flat surface
- Limited to where horizontal pin type tooth is mainly used.

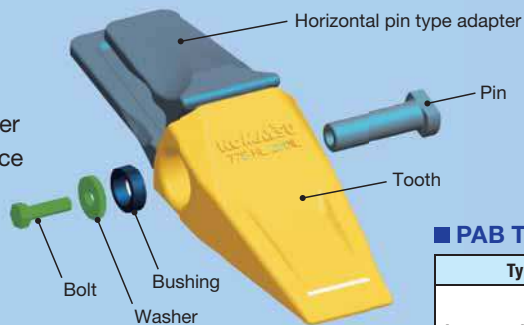

■ PAB Tooth Line-up

Type	Style
Integrated Long Life IL	
Heavy Standard HS	
Heavy Rock HR	



Set PAB tooth to horizontal pin type adapter



Insert exclusive pin to the adapter pin hole



Set bushing, washer and bolt and tighten by a ratchet wrench

Special Purpose Bucket & Ripper

■ Feature and Specifications

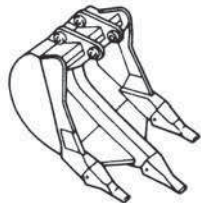
Type	Feature	Bucket Capacity (SAE J 296 Heaped)	Width	Image
Ripper Bucket	Suitable for digging rock bed or hard clayey soil when normal buckets cannot penetrate deep enough. Loading is also possible.	0.90 m ³	1200 mm	



HENSLEY BRAND BUCKET

Diverse Bucket Capacity by Application Featuring "KMAX" Tooth System



- Wide range selection for each application
- Larger profile and capacity to maximize production
- Multiple width options to meet specific job requirements and reduce backfill

Category and Recommended Applications

Category	Recommended Applications	Image
Trenching and Loading TL	Dirt, loam, sand, gravel, loose clay, abrasive soils with limited rock mixture.	
Heavy Duty Plate Lip Bucket with Wear Plate HP	Abrasive soils, compact or dense gravel, loose rock and gravel.	
Heavy Duty Plate Lip Bucket with Wear Plate & Wear Strips HPS	Abrasive soils, compact or dense clay, loose rock and gravel.	
Extreme Duty Plate Lip Bucket with Special Features HPX	Shot rock, stratified materials, quarry or tough, highly abrasive applications.	

Bucket Line-up

Category	Capacity (m³)	Width (mm)	Weight (kg)	Tooth Quantity	Boom + Arm (m)				Tooth Type
					6.47+2.22	6.47+2.55	6.47+3.19	6.47+4.02	
TL	0.68	610	962	3	☆	☆	☆	☆	✓
	0.93	762	1108	4	☆	☆	☆	☆	✓
	1.18	914	1209	4	☆	☆	☆	○	✓
	1.44	1067	1336	5	☆	○	○	□	✓
	1.70	1219	1437	5	○	□	●	■	✓
	1.96	1372	1582	6	□	●	■	■	✓
HP	0.68	610	1051	3	☆	☆	☆	☆	✓
	0.93	762	1173	4	☆	☆	☆	☆	✓
	1.18	914	1315	4	☆	☆	☆	○	✓
	1.44	1067	1451	5	○	○	□	■	✓
	1.70	1219	1573	5	□	□	●	■	✓
	1.96	1372	1716	6	●	●	■	■	✓
HPS	0.68	610	1121	3	☆	☆	☆	☆	✓
	0.93	762	1281	4	☆	☆	☆	☆	✓
	1.18	914	1398	4	☆	☆	☆	○	✓
	1.44	1067	1561	5	○	○	□	■	✓
	1.70	1219	1696	5	□	□	●	■	✓
	1.96	1372	1857	6	●	●	■	■	✓
HPX	0.68	610	1184	3	☆	☆	☆	☆	✓
	0.93	762	1359	4	☆	☆	☆	☆	✓
	1.18	914	1501	4	☆	☆	○	□	✓
	1.44	1067	1696	5	○	□	□	■	✓
	1.70	1219	1838	5	□	●	●	■	✓
	1.96	1372	1980	6	●	●	■	■	✓

☆: Heavy duty work, density up to 2.1 t/m³ ○: General purpose use, density up to 1.8 t/m³
 □: General purpose use, density up to 1.5 t/m³ ●: Light duty work, density up to 1.2 t/m³
 ■: Light duty work, density up to 0.9 t/m³ ×: Not usable ✓: Selectable

Feature of KMAX Tooth System

- Better penetration and cycle times
- Hardness throughout the tooth
- Unique high strength design
- Unique reusable fastener
- Less "throw away" waste
- Fast tooth changeover



Tooth



The KMAX RC style tooth shown here offers a consumption ratio of 60%.

Fastener

Simple, reusable fastener system saves time and money by unlocking with a simple 90-degree turn.

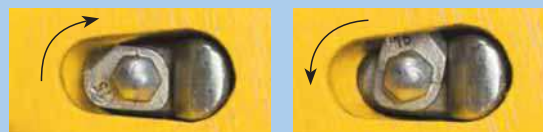

To lock, use the correct size socket, rotate the pin locking shaft 90-degree clockwise to finish the installation.

When removing the fastener, use the correct size socket to rotate the pin-locking shaft 90-degree counter-clockwise.

KMAX Tooth Line-up

Feature	Style
F Flare: Loose material for clean bottom and greater fill	
SYL Standard: General applications	
SD Chisel: General purpose tooth Designed for penetration	
RC Rock Chisel: Designed for penetration and long wear life	
T Tiger: Designed for good penetration with ribs for strength	
TV Tiger: Offers best penetration in tight material	
UT Twin Tiger: Offers longer life penetration for corners	
WT Twin Tiger: Designed for penetration for corners	

Some application may not have been available in your country or region. If you are interested in such application, please contact a KOMATSU office near you.

SPECIAL SPECS.

Attachment Piping Specification

Equips PC300-8M0 for breaker and crusher installation. Hydraulic flow rate can be regulated by setting Breaker Mode on monitor panel during breaker operation.



Super Long Front

Super long front attachment boasts a huge digging reach. An excavator with this attachment highly improves working efficiency in various works such as river conservation, lake dredging, slopefinishing and materials carrying where an extensively long reach is required.

Specifications

	PC300LC-8M0
Reach	16.5 m
Max. Bucket Capacity (SAE J 296 Heaped)	0.69 m ³
Boom Length	9.2 m
Arm Length	6.4 m

Working Range

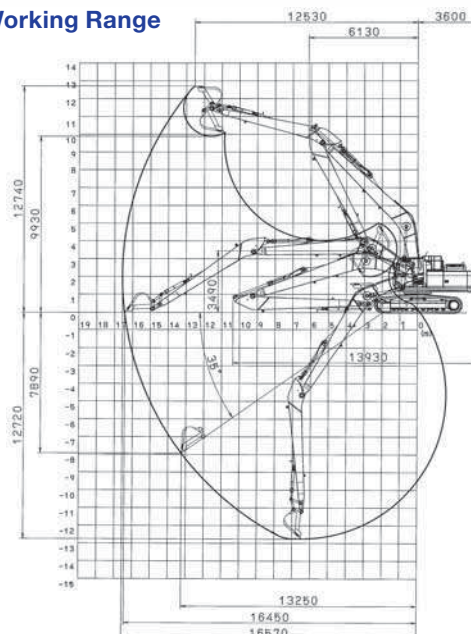

ATTACHMENT

Komatsu Genuine Attachment Tool

Komatsu-recommended attachment tools for hydraulic excavators
A wide range of attachment tools are provided to suit customers' specific applications.

Hydraulic breaker

The hydraulic breaker is an attachment tool used for crushing rock beds and paved surfaces, demolishing concrete structures, etc. The large gas chamber, ideal gas pressure ratio, and long-stroke piston deliver a powerful impact force. Since the breaker unit does not require an accumulator, the number of parts has been reduced, resulting in lower maintenance costs.



Crusher

This attachment tool is used for demolishing concrete structures. Since it does not have a striking mechanism and features low noise and low vibration, it is suitable for work in urban areas. The open-close cylinder is equipped with a speed-up valve for increasing work speed.



Primary crusher



Pulverizer



Scrap & demolition shear

The scrap & demolition shears have multiple applications for both overhead-demolishing the steel structure (General structural steels) and cutting structural steel with required length at ground level. (In foundries, dumps, scrap yards)



Applications of Attachment Tools

Application/ Attachment Tool	Civil Engineering	Quarry	Demolition	Industrial Waste Disposal	Iron-making	Utility Construction	Rental
Hydraulic Breaker	○	○	○	○	○	○	○
Crusher (Primary Crusher)			○				○
Crusher (Pulverizer)			○	○			○
Scrap & Demolition Shear			○	○			○

KOMATSU TOTAL SUPPORT



Komatsu Total Support

To keep your machine available and minimize operation cost when you need it, Komatsu Distributor is ready to provide variety of support before and after procuring the machine.

Fleet recommendation

Komatsu Distributor can study customer job site and provide the most optimum fleet recommendation with detailed information to meet all of your application needs when you are considering to buy new machines or to replace the existing ones from Komatsu.



Product support

Komatsu Distributor secure the certain quality of machine will be delivered.

Parts availability

Komatsu Distributor is available for emergency inquiry by the customers for genuine, quality guaranteed Komatsu parts.

Technical support

Komatsu product support service (Technical support) are designed to help customer. Komatsu Distributor offers a variety of effective services how much Komatsu is dedicated to the maintenance and support of Komatsu machine.

- Preventive Maintenance (PM) clinic
- Oil & Wear analysis program
- Undercarriage inspection service, etc.



Repair & maintenance service

Komatsu Distributor offers quality repair service, periodical maintenance, and maintenance service to the customer, utilizing and promoting Komatsu developed programs.

Komatsu Reman (Remanufactured) components

Komatsu Reman products are the result of the implementation of the Komatsu global Reman policy which establishes and agrees to reduce the owning, operating and total Life Cycle Costs (LCC) to Komatsu's customer through prompt delivery, high quality and competitively priced in own remanufactured products (QDC).



SPECIFICATIONS



ENGINE

Model Komatsu SAA6D114E-3
 Type Water-cooled, 4-cycle, direct injection
 Aspiration Turbocharged, aftercooled
 Number of cylinders 6
 Bore 114 mm
 Stroke 135 mm
 Piston displacement 8.27 L
 Horsepower:
 SAE J1995 Gross 194 kW 260 HP
 ISO 9249 / SAE J1349 Net 187 kW 250 HP
 Rated rpm 1950 min⁻¹
 Fan drive method for radiator cooling Mechanical
 Governor All-speed control, electronic

U.S. EPA Tier 3 and EU Stage 3A emissions equivalent.



HYDRAULICS

Type .. HydraulMind (Hydraulic Mechanical Intelligence New Design) system, closed-center system with load sensing valves and pressure compensated valves
 Number of selectable working modes 6
 Main pump:
 Type Two variable displacement piston type
 Pumps for Boom, arm, bucket, swing, and travel circuits
 Maximum flow 535 L/min
 Supply for control circuit Self-reducing valve
 Hydraulic motors:
 Travel 2 x axial piston motor with parking brake
 Swing 1 x axial piston motor with swing holding brake
 Relief valve setting:
 Implement circuits 37.3 MPa 380 kg/cm²
 Travel circuit 37.3 MPa 380 kg/cm²
 Swing circuit 27.9 MPa 285 kg/cm²
 Pilot circuit 3.2 MPa 33 kg/cm²
 Hydraulic cylinders:
 (Number of cylinders – bore x stroke x rod diameter)
 Boom 2–140 mm x 1480 mm x 100 mm
 Arm 1–160 mm x 1825 mm x 110 mm
 Bucket for 4.02 m arm 1–140 mm x 1285 mm x 100 mm
 for 3.19 m arm 1–140 mm x 1285 mm x 100 mm
 for 2.55 m arm 1–150 mm x 1285 mm x 110 mm
 for 2.22 m arm 1–150 mm x 1285 mm x 110 mm



DRIVES AND BRAKES

Steering control Two levers with pedals
 Drive method Hydrostatic
 Maximum drawbar pull 264 kN 26900 kg
 Gradeability 70%, 35°
 Maximum travel speed: High 5.5 km/h
 (Auto-shift) Mid 4.5 km/h
 (Auto-shift) Low 3.2 km/h
 Service brake Hydraulic lock
 Parking brake Mechanical disc brake



SWING SYSTEM

Drive method Hydrostatic
 Swing reduction Planetary gear
 Swing circle lubrication Grease-bathed
 Service brake Hydraulic lock
 Holding brake/Swing lock Mechanical disc brake
 Swing speed 9.5 min⁻¹



UNDERCARRIAGE

Center frame X-frame
 Track frame Box-section
 Seal of track Sealed track
 Track adjuster Hydraulic
 Number of shoes (Each side):
 PC300-8M0 45
 PC300LC-8M0 48
 Number of carrier rollers 2 each side
 Number of track rollers (Each side):
 PC300-8M0 7
 PC300LC-8M0 8



COOLANT AND LUBRICANT CAPACITY (REFILLING)

Fuel tank 605 L
 Coolant 31.0 L
 Engine 37.0 L
 Final drive (Each side) 9.0 L
 Swing drive 16.0 L
 Hydraulic tank 188 L



OPERATING WEIGHT (APPROXIMATE)

Operating weight including 6470 mm one-piece boom, 3185 mm arm, SAE J 296 heaped 1.40 m³ backhoe bucket, rated capacity of lubricants, coolant, full fuel tank, operator, and standard equipment.

Shoes	PC300-8M0		PC300LC-8M0	
	Operating Weight	Ground Pressure	Operating Weight	Ground Pressure
600 mm	31100 kg	62.9 kPa 0.64 kg/cm ²	31600 kg	59.0 kPa 0.60 kg/cm ²
700 mm	31660 kg	54.8 kPa 0.56 kg/cm ²	32200 kg	51.6 kPa 0.53 kg/cm ²
800 mm	32010 kg	48.5 kPa 0.49 kg/cm ²	32580 kg	45.7 kPa 0.47 kg/cm ²



DIMENSIONS

Model		PC300-8M0 / PC300LC-8M0			
Boom Length		6470 mm			
Arm Length		2220 mm	2550 mm	3185 mm	4020 mm
A	Overall length	11300 mm	11180 mm	11140 mm	11170 mm
B	Length on ground (Transport)	7320 mm / 7495 mm	6685 mm / 6860 mm	5755 mm / 5930 mm	5300 mm / 5475 mm
C	Overall height (To top of boom)*	3480 mm	3450 mm	3285 mm	3760 mm

Model		PC300-8M0	PC300LC-8M0
D	Overall width	3190 mm	3290 mm
E	Overall height (To top of cab)*	3145 mm	3145 mm
F	Ground clearance, counterweight	1185 mm	1185 mm
G	Ground clearance (Minimum)	500 mm	500 mm
H	Tail swing radius	3450 mm	3450 mm
I	Track length on ground	3700 mm	4030 mm
J	Track length	4625 mm	4955 mm
K	Track gauge	2590 mm	2590 mm
L	Width of crawler	3190 mm	3290 mm
M	Shoe width	600 mm	700 mm
N	Grouser height	36 mm	36 mm
O	Machine cab height	2585 mm	2585 mm
P	Machine cab width**	3090 mm	3090 mm
Q	Distance, swing center to rear end	3405 mm	3405 mm

* Including grouser height ** Including handrail

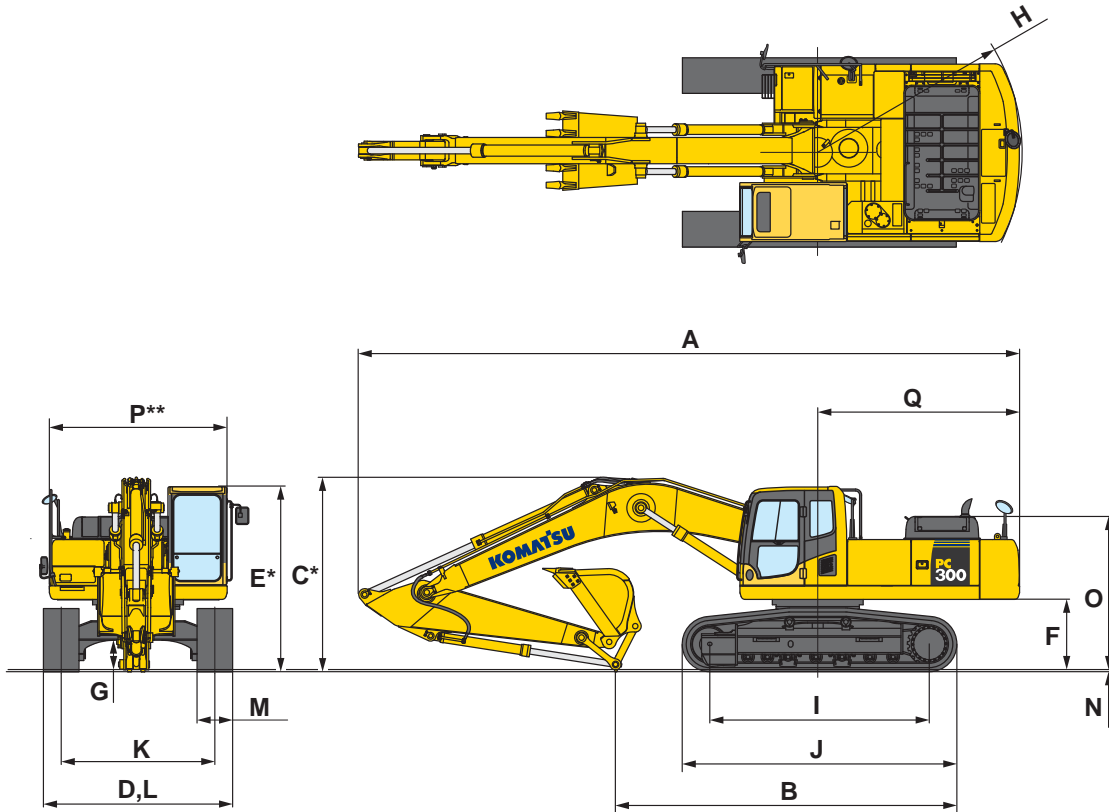

WORKING RANGE

Model		PC300-8M0 / PC300LC-8M0			
Boom Length		6470 mm			
Arm Length		2220 mm	2550 mm	3185 mm	4020 mm
A	Max. digging height	9460 mm	9965 mm	10100 mm	10550 mm
B	Max. dumping height	6520 mm	6895 mm	7050 mm	7490 mm
C	Max. digging depth	6400 mm	6750 mm	7380 mm	8200 mm
D	Max. vertical wall digging depth	4890 mm	5880 mm	6400 mm	7280 mm
E	Max. digging depth of cut for 2440 mm level	6130 mm	6520 mm	7180 mm	8045 mm
F	Max. digging reach	10120 mm	10550 mm	11100 mm	11900 mm
G	Max. digging reach at ground level	9910 mm	10355 mm	10920 mm	11730 mm
H	Min. swing radius	4470 mm	4450 mm	4310 mm	4370 mm
SAE 1179 Rating	Bucket digging force at power max.	228 kN 23300 kg	228 kN 23300 kg	200 kN 20400 kg	200 kN 20400 kg
	Arm crowd force at power max.	225 kN 22900 kg	193 kN 19700 kg	165 kN 16800 kg	139 kN 14200 kg
ISO 6015 Rating	Bucket digging force at power max.	259 kN 26400 kg	259 kN 26400 kg	227 kN 23100 kg	227 kN 23100 kg
	Arm crowd force at power max.	235 kN 24000 kg	201 kN 20500 kg	171 kN 17400 kg	144 kN 14700 kg

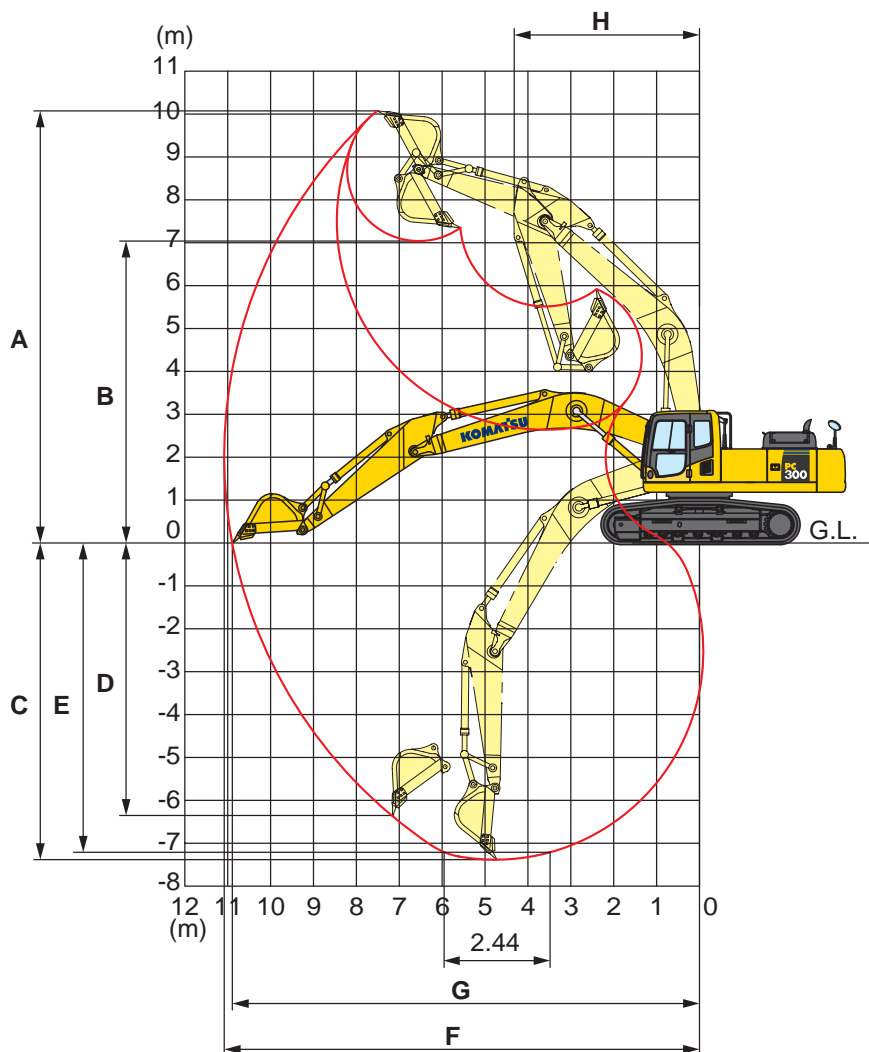



LIFTING CAPACITY WITH LIFTING MODE

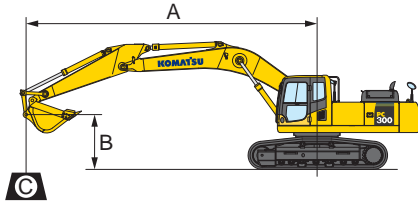

- A: Reach from swing center
- B: Bucket hook height
- C: Lifting capacity
- Cf: Rating over front
- Cs: Rating over side
- ⊗: Rating at maximum reach

PC300-8M0		Boom: 6470 mm		Arm: 2220 mm		Bucket: 1.40 m ³ SAE J 296 heaped		Shoe: 600 mm triple grouser					
B	A	⊗ MAX		9.0m		7.5 m		6.0 m		4.5 m		3.0 m	
		Cf	Cs	Cf	Cs	Cf	Cs	Cf	Cs	Cf	Cs	Cf	Cs
7.5 m		*8650 kg	6750 kg										
6.0 m		7350 kg	5000 kg			7450 kg	5100 kg	*9100 kg	7700 kg				
4.5 m		6200 kg	4150 kg			7250 kg	4900 kg	*10250 kg	7200 kg	*13800 kg	11600 kg		
3.0 m		5650 kg	3750 kg			6950 kg	4650 kg	10050 kg	6700 kg				
1.5 m		5450 kg	3550 kg			6700 kg	4400 kg	9600 kg	6250 kg				
0 m		5600 kg	3650 kg			6550 kg	4250 kg	9300 kg	6000 kg				
-1.5 m		6150 kg	4000 kg			6500 kg	4250 kg	9250 kg	5950 kg	15150 kg	9550 kg		
-3.0 m		7550 kg	4900 kg					9400 kg	6100 kg	*13400 kg	9750 kg	*14850 kg	*14850 kg
-4.5 m		*7750 kg	7350 kg					*6550 kg	6450 kg	*9850 kg	*9850 kg		

PC300-8M0		Boom: 6470 mm		Arm: 2550 mm		Bucket: 1.40 m ³ SAE J 296 heaped		Shoe: 600 mm triple grouser					
B	A	⊗ MAX		9.0m		7.5 m		6.0 m		4.5 m		3.0 m	
		Cf	Cs	Cf	Cs	Cf	Cs	Cf	Cs	Cf	Cs	Cf	Cs
7.5 m		*7600 kg	5750 kg										
6.0 m		6500 kg	4450 kg			7550 kg	5200 kg						
4.5 m		5600 kg	3750 kg			7350 kg	5000 kg	*9900 kg	7350 kg	*13000 kg	11900 kg		
3.0 m		5150 kg	3400 kg	5150 kg	3400 kg	7050 kg	4700 kg	10200 kg	6850 kg	*15500 kg	10650 kg		
1.5 m		5000 kg	3250 kg	5000 kg	3250 kg	6750 kg	4450 kg	9700 kg	6350 kg				
0 m		5100 kg	3300 kg	4950 kg	3200 kg	6600 kg	4300 kg	9400 kg	6100 kg	*14650 kg	9500 kg		
-1.5 m		5550 kg	3600 kg			6500 kg	4250 kg	9250 kg	6000 kg	*15200 kg	9550 kg		
-3.0 m		6600 kg	4300 kg			6600 kg	4300 kg	9350 kg	6050 kg	*14250 kg	9750 kg	*17150 kg	*17150 kg
-4.5 m		*7400 kg	6000 kg					*8300 kg	6350 kg	*11050 kg	9950 kg	*13100 kg	*13100 kg

PC300-8M0		Boom: 6470 mm		Arm: 3185 mm		Bucket: 1.40 m ³ SAE J 296 heaped		Shoe: 600 mm triple grouser					
B	A	⊗ MAX		9.0m		7.5 m		6.0 m		4.5 m		3.0 m	
		Cf	Cs	Cf	Cs	Cf	Cs	Cf	Cs	Cf	Cs	Cf	Cs
7.5 m		*5300 kg	4950 kg			*6850 kg	5400 kg						
6.0 m		*5250 kg	3950 kg			*7250 kg	5350 kg						
4.5 m		5050 kg	3350 kg	5350 kg	3600 kg	7500 kg	5150 kg	*9200 kg	7600 kg				
3.0 m		4700 kg	3050 kg	5250 kg	3450 kg	7150 kg	4850 kg	10450 kg	7050 kg	*15000 kg	11200 kg		
1.5 m		4550 kg	2950 kg	5050 kg	3300 kg	6900 kg	4550 kg	9900 kg	6550 kg	16000 kg	10200 kg		
0 m		4600 kg	3000 kg	4950 kg	3200 kg	6650 kg	4350 kg	9500 kg	6200 kg	15400 kg	9700 kg		
-1.5 m		4950 kg	3200 kg	4900 kg	3150 kg	6550 kg	4250 kg	9350 kg	6050 kg	15250 kg	9550 kg	*9600 kg	*9600 kg
-3.0 m		5750 kg	3750 kg			6550 kg	4250 kg	9350 kg	6050 kg	15300 kg	9700 kg	*18050 kg	*18050 kg
-4.5 m		7450 kg	4900 kg					9450 kg	6200 kg	*12850 kg	9950 kg	*16600 kg	*16600 kg
-6.0 m		*6300 kg	*6300 kg							*8150 kg	*8150 kg		

PC300-8M0		Boom: 6470 mm		Arm: 4020 mm		Bucket: 1.14 m ³ SAE J 296 heaped		Shoe: 600 mm triple grouser							
B	A	⊗ MAX		9.0m		7.5 m		6.0 m		4.5 m		3.0 m		1.5 m	
		Cf	Cs	Cf	Cs	Cf	Cs	Cf	Cs	Cf	Cs	Cf	Cs	Cf	Cs
7.5 m		*4150 kg	4050 kg												
6.0 m		*4050 kg	3300 kg	5700 kg	3900 kg										
4.5 m		*4150 kg	2900 kg	5550 kg	3750 kg	*7100 kg	5350 kg								
3.0 m		4100 kg	2650 kg	5350 kg	3600 kg	7350 kg	5000 kg	*9650 kg	7300 kg	*12950 kg	11800 kg				
1.5 m		3950 kg	2550 kg	5150 kg	3400 kg	7000 kg	4650 kg	10100 kg	6750 kg	*15950 kg	10550 kg				
0 m		4000 kg	2550 kg	5000 kg	3250 kg	6700 kg	4400 kg	9600 kg	6250 kg	15450 kg	9700 kg				
-1.5 m		4250 kg	2700 kg	4850 kg	3100 kg	6500 kg	4200 kg	9250 kg	5950 kg	15050 kg	9350 kg	*9750 kg	*9750 kg	*6900 kg	*6900 kg
-3.0 m		4750 kg	3050 kg	4850 kg	3100 kg	6450 kg	4150 kg	9150 kg	5900 kg	15000 kg	9350 kg	*15450 kg	*15450 kg	*9900 kg	*9900 kg
-4.5 m		5800 kg	3750 kg			6500 kg	4200 kg	9250 kg	6000 kg	*14500 kg	9550 kg	*20000 kg	19800 kg	*14850 kg	*14850 kg
-6.0 m		*6550 kg	5400 kg					*8150 kg	6250 kg	*11050 kg	9850 kg	*14600 kg	*14600 kg		

* Load is limited by hydraulic capacity rather than tipping. Ratings are based on SAE J1097. Rated loads do not exceed 87% of hydraulic lift capacity or 75% of tipping load.



LIFTING CAPACITY WITH LIFTING MODE

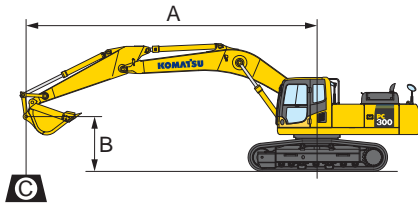

- A: Reach from swing center
- B: Bucket hook height
- C: Lifting capacity
- Cf: Rating over front
- Cs: Rating over side
- ⊗: Rating at maximum reach

PC300LC-8M0 Boom: 6470 mm Arm: 2220 mm Bucket: 1.40 m ³ SAE J 296 heaped Shoe: 700 mm triple grouser													
B	A	⊗ MAX		9.0m		7.5 m		6.0 m		4.5 m		3.0 m	
		Cf	Cs	Cf	Cs	Cf	Cs	Cf	Cs	Cf	Cs	Cf	Cs
7.5 m		*8650 kg	7050 kg										
6.0 m		*8300 kg	5300 kg			*8200 kg	5350 kg	*9100 kg	8050 kg				
4.5 m		7350 kg	4400 kg			8550 kg	5150 kg	*10250 kg	7550 kg	*13800 kg	12100 kg		
3.0 m		6700 kg	3950 kg			8250 kg	4900 kg	*11550 kg	7050 kg				
1.5 m		6500 kg	3800 kg			8000 kg	4700 kg	11450 kg	6600 kg				
0 m		6700 kg	3850 kg			7850 kg	4500 kg	11150 kg	6350 kg				
-1.5 m		7350 kg	4250 kg			7800 kg	4500 kg	11100 kg	6300 kg	*15500 kg	10100 kg		
-3.0 m		*8600 kg	5200 kg					*10550 kg	6450 kg	*13400 kg	10300 kg	*14850 kg	*14850 kg
-4.5 m		*7750 kg	*7750 kg					*6550 kg	*6550 kg	*9850 kg	*9850 kg		

PC300LC-8M0 Boom: 6470 mm Arm: 2550 mm Bucket: 1.40 m ³ SAE J 296 heaped Shoe: 700 mm triple grouser													
B	A	⊗ MAX		9.0m		7.5 m		6.0 m		4.5 m		3.0 m	
		Cf	Cs	Cf	Cs	Cf	Cs	Cf	Cs	Cf	Cs	Cf	Cs
7.5 m		*7600 kg	6000 kg										
6.0 m		*7450 kg	4650 kg			*7850 kg	5450 kg						
4.5 m		6650 kg	3950 kg			*8300 kg	5250 kg	*9900 kg	7700 kg	*13000 kg	12400 kg		
3.0 m		6100 kg	3600 kg	6100 kg	3600 kg	8350 kg	5000 kg	*11300 kg	7150 kg	*15550 kg	11200 kg		
1.5 m		5950 kg	3450 kg	6000 kg	3500 kg	8050 kg	4750 kg	11550 kg	6700 kg				
0 m		6100 kg	3500 kg	5900 kg	3400 kg	7850 kg	4550 kg	11250 kg	6450 kg	*14650 kg	10000 kg		
-1.5 m		6650 kg	3850 kg			7800 kg	4500 kg	11100 kg	6350 kg	*16200 kg	10050 kg		
-3.0 m		7900 kg	4550 kg			7850 kg	4550 kg	*11050 kg	6400 kg	*14250 kg	10250 kg	*17150 kg	*17150 kg
-4.5 m		*7400 kg	6300 kg					*8300 kg	6700 kg	*11050 kg	10450 kg	*13100 kg	*13100 kg

PC300LC-8M0 Boom: 6470 mm Arm: 3185 mm Bucket: 1.40 m ³ SAE J 296 heaped Shoe: 700 mm triple grouser													
B	A	⊗ MAX		9.0m		7.5 m		6.0 m		4.5 m		3.0 m	
		Cf	Cs	Cf	Cs	Cf	Cs	Cf	Cs	Cf	Cs	Cf	Cs
7.5 m		*5300 kg	5200 kg			*6850 kg	5650 kg						
6.0 m		*5250 kg	4150 kg			*7250 kg	5600 kg						
4.5 m		*5400 kg	3550 kg	6350 kg	3800 kg	*7800 kg	5400 kg	*9200 kg	7950 kg				
3.0 m		5600 kg	3250 kg	6200 kg	3700 kg	8450 kg	5100 kg	*10650 kg	7400 kg	*15000 kg	11750 kg		
1.5 m		5450 kg	3150 kg	6050 kg	3550 kg	8150 kg	4850 kg	11800 kg	6900 kg	*16700 kg	10700 kg		
0 m		5550 kg	3200 kg	5900 kg	3400 kg	7950 kg	4600 kg	11400 kg	6550 kg	*17550 kg	10200 kg		
-1.5 m		5950 kg	3400 kg	5850 kg	3350 kg	7800 kg	4500 kg	11200 kg	6400 kg	*17000 kg	10100 kg	*9600 kg	*9600 kg
-3.0 m		6850 kg	3950 kg			7800 kg	4500 kg	11200 kg	6400 kg	*15550 kg	10200 kg	*18050 kg	*18050 kg
-4.5 m		*7550 kg	5150 kg					*9750 kg	6550 kg	*12850 kg	10500 kg	*16600 kg	*16600 kg
-6.0 m		*6300 kg	*6300 kg							*8150 kg	*8150 kg		

PC300LC-8M0 Boom: 6470 mm Arm: 4020 mm Bucket: 1.14 m ³ SAE J 296 heaped Shoe: 700 mm triple grouser															
B	A	⊗ MAX		9.0m		7.5 m		6.0 m		4.5 m		3.0 m		1.5 m	
		Cf	Cs	Cf	Cs	Cf	Cs	Cf	Cs	Cf	Cs	Cf	Cs	Cf	Cs
7.5 m		*4150 kg	*4150 kg												
6.0 m		*4050 kg	3500 kg	*6250 kg	4100 kg										
4.5 m		*4150 kg	3100 kg	*6500 kg	4000 kg	*7100 kg	5600 kg								
3.0 m		*4300 kg	2800 kg	6350 kg	3800 kg	*8000 kg	5300 kg	*9650 kg	7650 kg	*12950 kg	12300 kg				
1.5 m		*4650 kg	2700 kg	6150 kg	3600 kg	8300 kg	4950 kg	*11200 kg	7100 kg	*15950 kg	11050 kg				
0 m		4800 kg	2700 kg	5950 kg	3450 kg	8000 kg	4650 kg	11450 kg	6600 kg	*17250 kg	10250 kg				
-1.5 m		5100 kg	2900 kg	5850 kg	3350 kg	7750 kg	4450 kg	11100 kg	6300 kg	*17250 kg	9850 kg	*9750 kg	*9750 kg	*6900 kg	*6900 kg
-3.0 m		5700 kg	3250 kg	5850 kg	3300 kg	7700 kg	4400 kg	11000 kg	6250 kg	*16400 kg	9850 kg	*15450 kg	*15450 kg	*9900 kg	*9900 kg
-4.5 m		6950 kg	4000 kg			7800 kg	4500 kg	*10900 kg	6350 kg	*14500 kg	10050 kg	*20000 kg	*20000 kg	*14850 kg	*14850 kg
-6.0 m		*6550 kg	5700 kg					*8150 kg	6600 kg	*11050 kg	10300 kg	*14600 kg	*14600 kg		

* Load is limited by hydraulic capacity rather than tipping. Ratings are based on SAE J1097. Rated loads do not exceed 87% of hydraulic lift capacity or 75% of tipping load.



STANDARD EQUIPMENT

ENGINE:

- Automatic engine warm-up system
- Dry type air cleaner, double element
- Engine, Komatsu SAA6D114E-3
- Engine overheat prevention system
- Radiator and oil cooler dust proof net
- Suction fan

ELECTRICAL SYSTEM:

- Alternator, 24 V/60 A
- Auto-decelerator
- Batteries, 2 X 12 V/126 Ah
- Starting motor, 24 V/7.5 kW
- Working light, 2 (Boom and RH)

HYDRAULIC SYSTEM:

- Boom holding valve
- Power maximizing system
- Pressure Proportional Control (PPC) hydraulic control system
- Two-mode settings for boom
- Working mode selection system

GUARDS AND COVERS:

- Fan guard structure
- Track guiding guard, center section

UNDERCARRIAGE:

- Hydraulic track adjusters (Each side)
 - PC300-8M0, 7 each side
 - PC300LC-8M0, 8 each side
- Track shoe
 - PC300-8M0, 600 mm triple grouser
 - PC300LC-8M0, 700 mm triple grouser

OPERATOR ENVIRONMENT:

- A/C with defroster
- Large multi-lingual high resolution LCD monitor
- Rear view mirrors (RH, LH, rear, sidewise)
- ROPS cab (ISO 12117-2)
- Seat belt, retractable

OTHER EQUIPMENT:

- Counterweight
- Electric horn
- Rear reflector
- Slip-resistant plates
- Travel alarm



OPTIONAL EQUIPMENT

ENGINE:

- Additional filter system for poor-quality fuel (Water separator)
- Large capacity fuel pre-filter



ELECTRICAL SYSTEM:

- Batteries, 2 X 12 V/140 Ah
- Working lights (2 on cab)

HYDRAULIC SYSTEM:

- Long lubricating intervals for implement bushing
- Service valve

UNDERCARRIAGE:

- Shoes, triple grouser shoes
 - PC300-8M0 700 mm, 800 mm
 - PC300LC-8M0 600 mm, 800 mm
- Track frame undercover
- Track roller guards (Full length)

OPERATOR ENVIRONMENT:

- Bolt-on top guard, OPG top guard level 2 (ISO 10262)
- Cab accessories
 - Rain visor
 - Sun visor
- Cab front guard
 - Full height guard, OPG level 1 (ISO 10262)

- Full height guard, OPG level 2 (ISO 10262)
- Half height guard
- Rear view monitor system
- Seat, suspension

WORK EQUIPMENT:

- Arms
 - 2220 mm arm assembly
 - 2550 mm arm assembly
 - 3185 mm arm assembly
 - 4020 mm arm assembly
- Boom
 - 6470 mm

OTHER EQUIPMENT:

- Electric grease gun
- Fuel refill pump

KOMATSU®