

# KOMATSU®

## WA380-8

*Tier 4 Final Engine*

**WHEEL LOADER**

WA380



Photos may include optional equipment.

**NET HORSEPOWER**

191 HP @ 2100 rpm  
143 kW @ 2100 rpm

**OPERATING WEIGHT**

40,532 – 41,932 lb  
18385 – 19020 kg

**BUCKET CAPACITY**

3.5 – 4.3 yd<sup>3</sup>  
2.7 – 3.3 m<sup>3</sup>

# WALK-AROUND

WA380-8



Photos may include optional equipment.

## NET HORSEPOWER

191 HP @ 2100 rpm  
143 kW @ 2100 rpm

## OPERATING WEIGHT

40,532 – 41,932 lb  
18385 – 19020 kg

## BUCKET CAPACITY

3.5 – 4.3 yd<sup>3</sup>  
2.7 – 3.3 m<sup>3</sup>



## PERFORMANCE, DURABILITY AND FUEL ECONOMY

### Large capacity torque converter with lock-up:

- Quick acceleration
- Lock-up in 2<sup>nd</sup>, 3<sup>rd</sup> and 4<sup>th</sup> gear

**Komatsu SmartLoader Logic** helps reduce fuel consumption with no decrease in production.

A powerful **Komatsu SAA6D107E-3 engine** provides a net output of 143 kW **191 HP** with up to 6% improved fuel consumption. This engine is EPA Tier 4 emissions certified.

**Komatsu Variable Geometry Turbocharger (KVGT)** is hydraulically actuated to provide optimum air flow under all speed and load conditions.

**Komatsu Diesel Particulate Filter (KDPF) and Selective Catalytic Reduction (SCR) systems** reduce particulate matter and NOx while providing automatic regeneration that does not interfere with daily operation.

### Fluid neutral or better

Combined fuel and DEF consumption is less than the WA380-7 fuel consumption.

### Hydraulically driven cooling fan

Auto-reversing fan is programmable and swings out for easy access to the wider core coolers.

**Remote boom and bucket positioners** allow the operator to set upper and lower boom kick-outs, as well as the bucket level from inside the cab.

**Variable displacement piston pumps with Closed-center Load Sensing System (CLSS)** provide quick hydraulic response and smooth operation to maximize productivity.

### Rearview monitoring system (standard)

### Enhanced working environment:

- High capacity air suspension seat, heated
- Seat mounted Electronic Pilot Controls (EPC) controls with F-N-R switch
- (2) 12V power outlets



**New-style plastic front fenders** add durability.

**Rear full fenders (standard)** are made of durable plastic and swing open for easy access to maintenance points.

### 7" LCD color monitor panel

Easy-to-read monitor with "ecology guidance" enables fuel efficient operation. Monitor panel onboard diagnostics remove the need for laptops during service.

**Komatsu auto idle shutdown** helps reduce idle time and operating costs.

### Engine air filter

Externally mounted on the rear LH fender for easier access and maintenance.

**KOMTRAX®** equipped machines send location, SMR and operation maps to a secure website or smart phone via wireless technology. Machines also relay error codes, cautions, maintenance items, fuel & Diesel Exhaust Fluid (DEF) levels, and much more.

**Operator identification system** tracks machine operation for up to 100 operators.

# PERFORMANCE FEATURES

## KOMATSU NEW ENGINE TECHNOLOGIES

### New Tier 4 Final Engine

The Komatsu SAA6D107E-3 engine is EPA Tier 4 Final emissions certified, reduces fuel consumption, and provides exceptional performance. Based on Komatsu proprietary technologies developed over many years, this new diesel engine reduces nitrogen oxides (NOx) by more than 80% compared to Tier 4 interim levels.

### Technologies Applied to New Engine

#### Heavy-duty after treatment system

This new system combines a Komatsu Diesel Particulate Filter (KDPF) and Selective Catalytic Reduction (SCR). The SCR NOx reduction system injects the precise amount of Diesel Exhaust Fluid (DEF) to break down NOx into non-toxic water vapor (H<sub>2</sub>O) and nitrogen gas (N<sub>2</sub>).

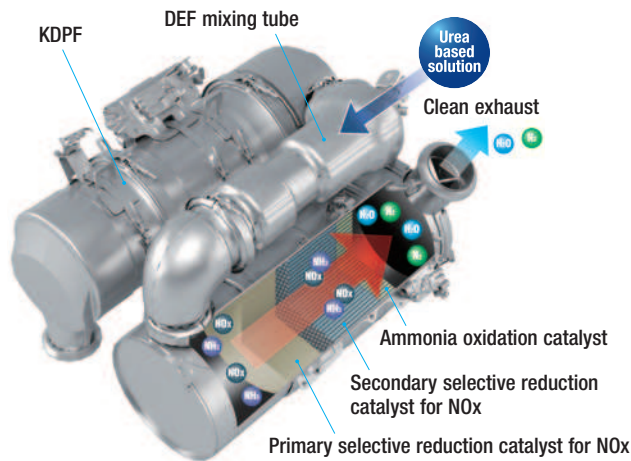

#### Heavy-duty cooled Exhaust Gas Recirculation (EGR) system

The system recirculates a portion of exhaust gas into the air intake and lowers combustion temperatures, thereby reducing NOx emissions. EGR gas flow is lower for Tier 4 Final with the addition of SCR technology. The system dramatically reduces NOx, while helping cut fuel consumption below Tier 4 Interim levels.

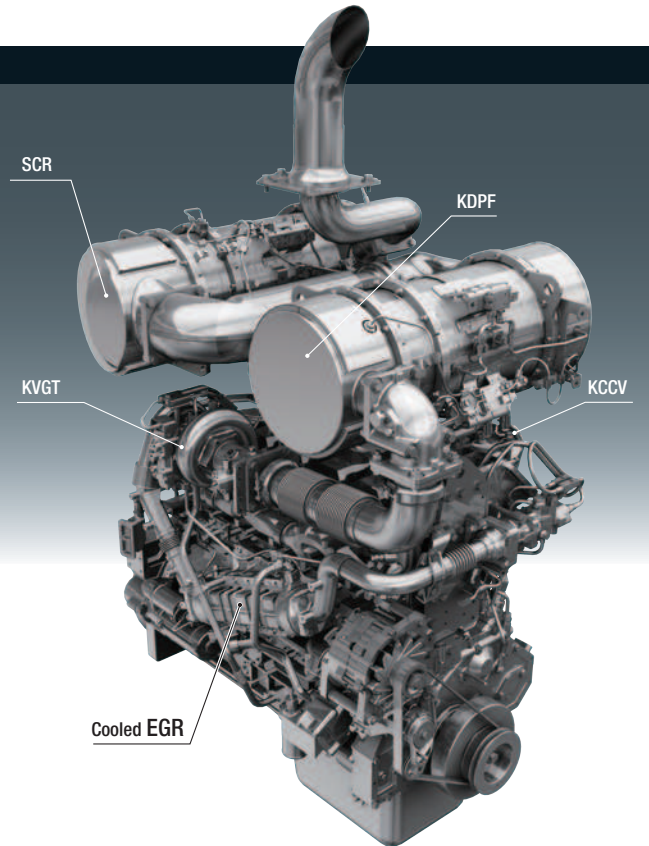
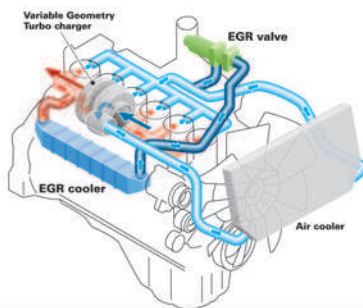

#### Advanced Electronic Control System

An improved electronic control system more effectively manages engine parameters such as airflow rate, EGR gas flow rate, fuel injection parameters, and after treatment function. The control system also provides enhanced diagnostics through the monitor panel. Additionally, managing information via KOMTRAX helps customers track required maintenance.

#### Komatsu Variable Geometry Turbocharger (KVG) system

The KVG features proven Komatsu-designed hydraulic technology for robust and accurate control under all speed and load conditions for optimal engine performance. The KVG also provides precise exhaust temperature control for efficient KDPF regeneration.

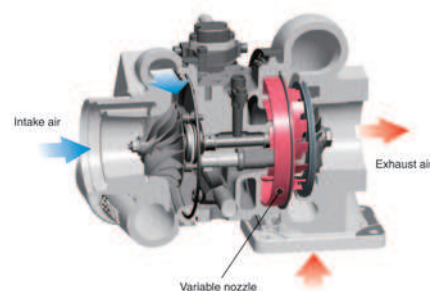

WA380-8

## Heavy-duty High-Pressure Common Rail (HPCR) fuel injection system

The system is specifically designed to achieve the optimal injection of fuel for near-complete combustion, which helps reduce PM emissions.

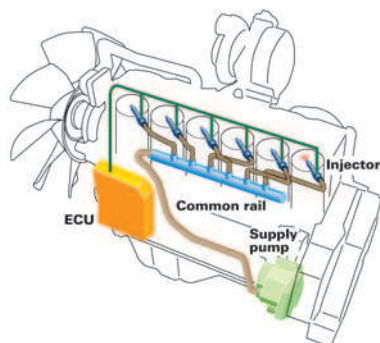

## Komatsu SmartLoader Logic

The WA380-8 features Komatsu SmartLoader Logic, which controls engine torque to match machine demands. For example, engine torque needs are higher for digging in V-shape loading, but lower when driving with an empty bucket. This system optimizes the engine torque for all applications to minimize fuel consumption. Komatsu SmartLoader Logic functions automatically and doesn't interfere with operation, saving fuel without decreasing production.

## Large-capacity Torque Converter

The Komatsu-designed power train features a large capacity torque converter for optimum efficiency. The WA380-8 has greater productivity in V-shape loading applications because the increased tractive effort does not require full throttle. The large capacity torque converter allows the loader to up-shift gears faster for improved acceleration and hill climbing ability. The WA380-8 achieves high gear ranges and maintains high travel speed when working in load-and-carry applications. In most applications, production is increased and fuel consumption is reduced, resulting in improved fuel efficiency.

## Enhanced Lock-up

The Komatsu designed torque converter with lock-up is standard on the WA380-8. The lock-up function activates in 2nd, 3rd and 4th gears. The lock-up torque converter is effective for both load and carry applications and V-shape loading in lower gears. Komatsu SmartLoader Logic reduces the clutch engagement shock of lock-up by controlling engine torque. The lock-up torque converter, combined with Komatsu SmartLoader Logic results in low fuel consumption and high travel speeds in load and carry, and even some V-cycle loading applications.

## Dual-mode Engine Power Select System

This wheel loader offers two selectable operating modes – Economy (E) and Power (P).

- E Mode: This mode provides maximum fuel efficiency for general loading.
- P Mode: This mode provides maximum power output for hard-digging operation or hill climbing.



- 1 Dual mode engine power selection switch
- 2 Transmission shift mode selector switch
- 3 Torque converter lock-up switch

## Automatic Transmission with Mode Select System

This operator-controlled system allows the operator to select manual shifting or two levels of automatic shifting (low, and high). Auto L mode is for fuel-saving operation with the gear-shift timing set at lower speeds than Auto H mode.

## CLSS Variable Displacement Piston Pump

The Closed-Center Load Sensing System (CLSS), with variable displacement piston pump, delivers precise hydraulic flow just as the operator demands. This prevents wasted hydraulic flow, which minimizes loss and contributes to better fuel efficiency.

## Komatsu Auto Idle Shutdown

In order to reduce unwanted idle time, Komatsu offers Komatsu auto idle shutdown. This function will shut the engine off and apply the parking brake and hydraulic lock after a preset idle time limit. This time limit can be set by the operator or service technician and may range from three to 60 minutes.

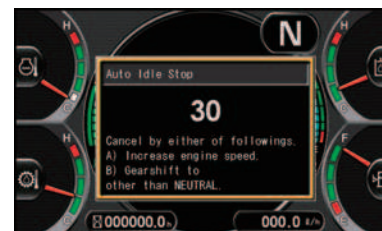

# OPERATOR ENVIRONMENT



WA380-8

## New Operator Seat with Electronic Pilot Control (EPC) Levers

A new standard, heated, air-suspension seat provides enhanced support on rough roads and dampens machine vibrations, providing a more comfortable ride for the operator. An EPC-lever console is built into and moves with the seat. The angle of the armrest is fully adjustable for optimum operator comfort. A secondary F-N-R switch is incorporated in to work equipment lever configurations.



## Tiltable / Telescopic Steering Wheel

The operator can tilt and telescope the steering wheel to allow maximum comfort and control. The two-spoke steering wheel allows maximum visibility of the monitor panel and the forward work environment.



## Low Noise Design

Operator's ear noise level : 72 dB(A)  
Dynamic noise level (outside): 108 dB(A)

The large ROPS/FOPS cab is mounted with Komatsu's unique viscous mounts. The low-noise engine, hydraulically-driven fan, and hydraulic pumps are mounted with rubber cushions, and the cab sealing is improved to provide a quiet, low-vibration, dustproof and comfortable operating environment.

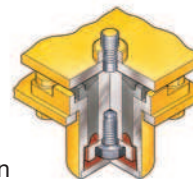

## Mono-lever with Integrated 3rd Spool Control (Optional)

The mono-lever allows the operator to control work equipment and the optional 3rd spool for the thumb increases ease of operation. The 3rd spool valve operates in either continuous or proportional flow modes. The mono-lever also includes a F-N-R switch.



**Rear View Monitoring System (standard)**

The dedicated full-color monitor on the right side of the cab provides the operator with a rear view from the machine. This monitor can be always on or only on when the loader shifts into reverse. Guidelines provide the operator with visual cues for the width of the loader.



**Engine Shutdown Secondary Switch**

The engine stop switch enables machine shutdown when accessing the key switch is not possible.

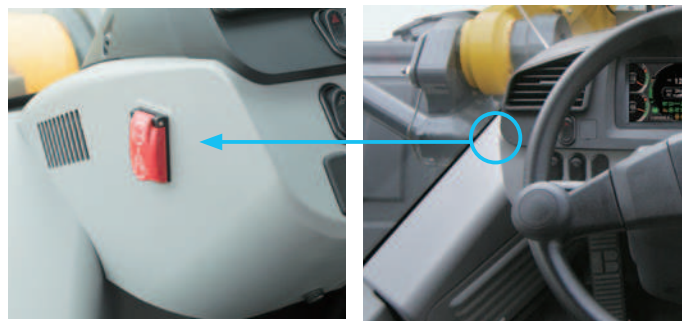

**Auxiliary Input (MP3 Jack) 12 V Outlets**

An Aux input for audio devices is standard as well as two 12 volt outlets. These are all located on the front of the right-hand console.

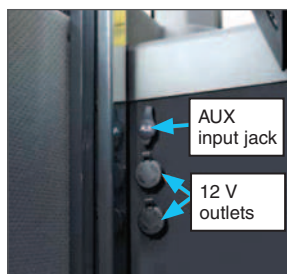

# WORKING ENVIRONMENT



## Easy Entry and Exit

The WA380-8 has an inclined ladder with wide steps and hand holds to ease entry and exit from the cab.

## Remote Bucket & Boom Positioner

The operator can set the bucket angle and remote boom positioner from the cab. Both upper and lower boom kick-outs are adjustable in the cab with the push of a button. The bucket positioner can store three horizontal settings, allowing the operator to easily change attachments without resetting the bucket level.

Remote positioner switch  
Boom / Bucket



## Automatic Kick-down

The WA380-8 has the ability to automatically downshift to F1, eliminating the need for the operator to manually downshift when entering the pile. This can be activated through the monitor.



## Electronically Controlled Suspension System

The electronically controlled suspension system, or ride control system, uses an accumulator to minimize boom arm shock, giving the operator a much smoother ride. This reduces operator fatigue and material spillage during load and carry operations. The electronically controlled suspension system is speed sensitive, meaning the boom won't move during low speed digging. This feature is standard on the WA380-8.

## Mono Lever With Integrated 3rd Spool Control (option)

The mono lever option has been designed for improved ergonomics and comfort. When equipped with the optional 3rd spool valve, it allows the operator to control the 3rd spool with the thumb. The 3rd spool valve can be operated in either continuous or proportional flow modes. The mono lever also includes a F-N-R switch.



### High Resolution 7-inch Color LCD Monitor

The 7-inch color TFT-LCD monitor can display maintenance information, operational records, ecology-guidance records and other machine data. The switch panel is used to select screens and adjust air conditioner and environmental controls.

#### Machine monitor

- 1 LCD unit
- 2 LED unit
- 3 Engine tachometer
- 4 Speedometer
- 5 Ecology gauge
- 6 Air conditioner display
- 7 Shift indicator
- 8 Engine coolant temperature gauge
- 9 Hydraulic oil temperature gauge
- 10 Torque converter oil temperature gauge
- 11 Fuel gauge
- 12 Message pilot lamp
- 13 Pilot lamps
- 14 DEF level gauge

#### Switch panel

- 1 Air conditioner switches / Numeral key pad
- 2 Function switches

### Visual user menu

Pressing the menu button on the switch panel accesses the user-menu screen. The menus are grouped by function, with easy-to-understand, intuitive icons for easier machine operation.

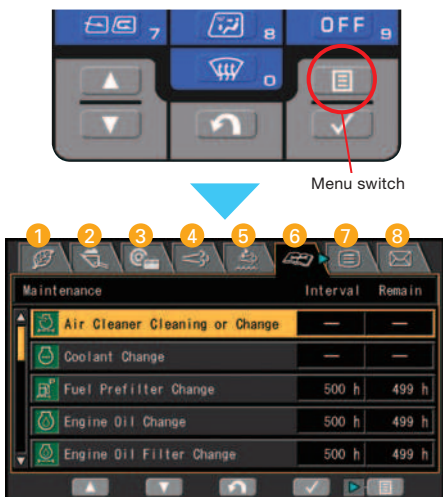

- 1 Energy saving guidance
- 2 Load-meter setting (optional)
- 3 Machine settings
- 4 Aftertreatment devices regeneration
- 5 SCR information
- 6 Maintenance
- 7 Monitor setting
- 8 Mail check

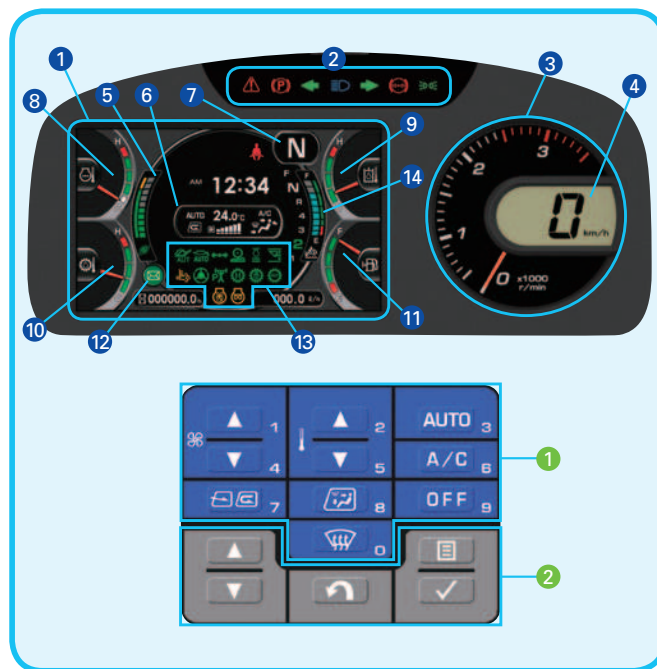

### Operator identification function

An operator identification (ID) code can be set for each operator, and used to manage operation information of individual machines through KOMTRAX. Data sent from KOMTRAX can be used to analyze operation status by operator job, as well as by machine.



### Monitor Panel with troubleshooting function minimizes downtime

Various meters, gauges and warning functions are centrally arranged on the monitor panel. The monitor simplifies start-up inspection and warns the operator with a lamp and buzzer if any abnormalities occur. Warnings are indicated in four levels, which the operator must acknowledge and clear. Replacement times for oil and filters are also indicated.



# MAINTENANCE FEATURES



WA380-8

## Side-opening Gull-wing Engine Doors

The large, gull-wing-type engine doors require minimal effort to open and close, thanks to gas assisted struts. The doors make access and daily maintenance easy. Large steps on each side of the frame also enhance accessibility.



## Auto Reversing Fan

The engine cooling fan is hydraulically driven. It can be set to reverse automatically during operation. Fan reverse mode and timing can be controlled through the monitor.



## Swing-Out Type Cooling Fan and Wide Core Radiator

The cooling fan swings out for easier cleaning. The coolers feature wide-spaced cooling fins to reduce clogging.



## DEF Tank

The DEF tank is easily accessed behind the RH side ladder. An external sight gauge helps prevent overflow and spillage while refilling.



## Battery Disconnect Switch

The battery disconnect switch is located on the right side of the machine. This can be used to disconnect power when performing service work on the machine.



## Engine Compartment

The WA380-8 engine compartment is designed for easy serviceability. Placement of maintenance items, such as filters, dipsticks, and oil-fill locations are laid out for easy-to-reach ground level access.

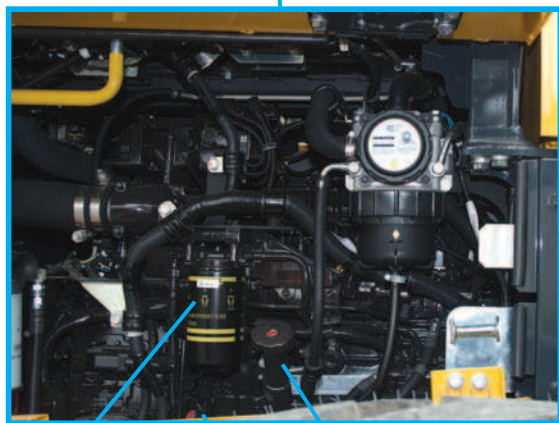
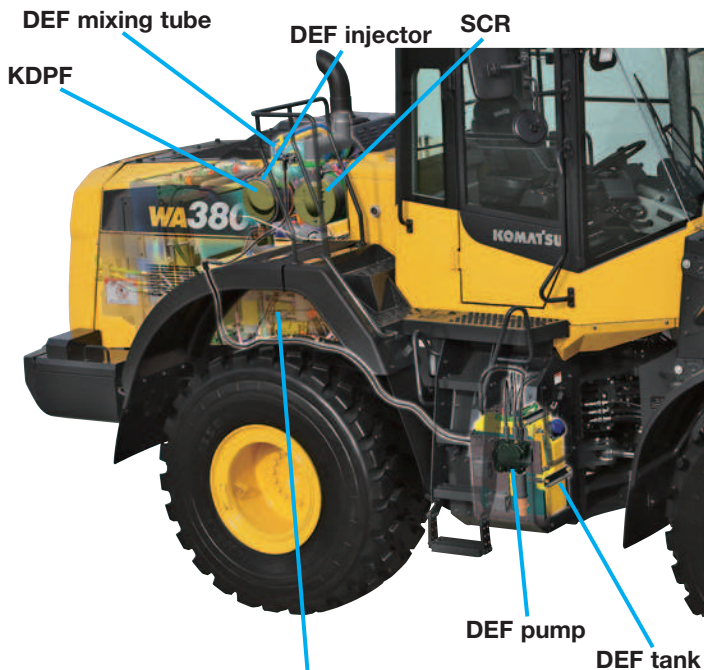

Fuel filter  
Engine oil fill  
Engine oil dipstick

## Rear Full Fenders (Standard)

Full rear fenders are standard on the WA380-8. The plastic rear fenders open outward, keeping the force required to open them low, even when covered with mud or snow. The fenders swing out of the way to give technicians easy access to the engine compartment. Mud flaps are also included on the fenders for additional machine protection.



## Cab Air Filter

The inside and outside air filters can be replaced easily without the need for tools. The outside filter is located behind a lockable door for security.



Inside air filter

Outside air filter

## LED Taillights

LED brake lights and reverse lights provide long bulb life, and excellent visibility.



## Engine Air Cleaner

The air cleaner is located on the left-side platform for easy access.



## Maintenance Information

### “Maintenance time caution lamp” display

When the time before required maintenance dips below 30 hours\*, the maintenance-time monitor appears. Pressing the menu switch displays the maintenance screen.

\* : The setting can be changed within the range between 10 and 200 hours.

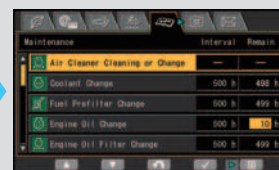

Maintenance screen

### Supports DEF level and refill timing

The DEF level gauge is displayed continuously on the monitor panel. In addition, when the refill timing is reached, the DEF-low-level icon appears to alert the operator.



DEF level gauge



DEF low level guidance

# KOMATSU PARTS & SERVICE SUPPORT



## Every new Komatsu Tier 4 Final construction machine is covered.

The Komatsu CARE program covers all new Komatsu Tier 4 Final construction equipment, whether rented, leased or purchased. For the first 3 years or 2,000 hours, whichever occurs first, you'll receive:

- Regular service at 500, 1,000, 1,500 and 2,000-hr. intervals
- DEF tank breather element replacement at 1,000 hours
- DEF and CCV filters replacement at 2,000 hours
- 50-point inspection by factory-trained technician at each scheduled interval
- Technician labor
- Fluids, oils, coolant, filters, SCR screen, tank breather and parts
- Technician travel to and from your equipment location

Plus two complimentary scheduled KDPF exchanges and SCR system service for 5 years-no hours limits.\*

Service will be performed by a Komatsu Distributor and only Komatsu genuine fluids and filters will be used.

Komatsu CARE® services are available from every Komatsu Distributor in the U.S. and Canada.



## Komatsu CARE® – Extended Coverage

- Extended Coverage can provide peace of mind by protecting customers from unplanned expenses that effect cash flow
- Purchasing extended coverage locks-in the cost of covered parts and labor for the coverage period and helps turn these into fixed costs



\* Some exclusions apply. Please contact your Komatsu distributor for specific program details.



## Komatsu Parts Support

- 24/7/365 to fulfill your parts needs
- 9 parts Distribution Centers strategically located across the U.S. and Canada
- Distributor network of more than 300 locations across U.S. and Canada to serve you
- Online part ordering through Komatsu eParts
- Remanufactured components with same-as-new warranties at a significant cost reduction



## Komatsu Oil and Wear Analysis (KOWA)

- KOWA detects fuel dilution, coolant leaks, and measures wear metals
- Proactively maintain your equipment
- Maximize availability and performance
- Can identify potential problems before they lead to major repairs
- Reduce life cycle cost by extending component life

# KOMTRAX EQUIPMENT MONITORING

GET THE WHOLE STORY WITH  
**KOMTRAX**<sup>®</sup>

✓ **WHAT**

- KOMTRAX is Komatsu's remote equipment monitoring and management system
- KOMTRAX **continuously monitors and records** machine health and operational data
- Information such as fuel consumption, utilization, and a detailed history **lowering owning and operating cost**

✓ **WHEN**

- Know when your machines are **running or idling** and make decisions that will improve your fleet utilization
- Detailed movement records ensure you know when and where your equipment is moved
- Up to date records allow you to **know when maintenance is due** and help you plan for future maintenance needs

✓ **WHERE**

- KOMTRAX data **can be accessed virtually anywhere** through your computer, the web or your smart phone
- Automatic alerts keep fleet managers up to date on the latest machine notifications

✓ **WHY**

- Knowledge is power - **make informed decisions** to manage your fleet better
- Knowing your idle time and fuel consumption will help maximize your machine efficiency
- **Take control of your equipment** - any time, anywhere

✓ **WHO**

- KOMTRAX is **standard** equipment on all Komatsu construction products



**KOMTRAX**<sup>®</sup>

For construction and compact equipment.

**KOMTRAX Plus**<sup>™</sup>

For production and mining class machines.





## DIMENSIONS

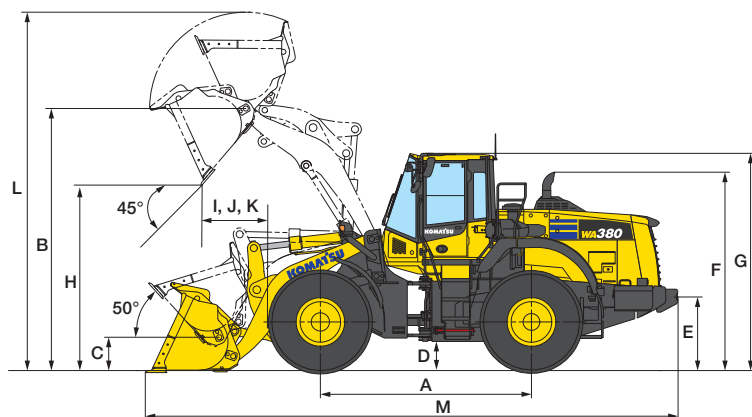

Tread	2160 mm	<b>7'1"</b>
Width over tires	2780 mm	<b>9'1"</b>
A Wheelbase	3300 mm	<b>10'10"</b>
B Hinge pin height,	Standard Boom	4095 mm <b>13'5"</b>
max. height	High Lift Boom	4625 mm <b>15'2"</b>
C Hinge pin height,	Standard Boom	520 mm <b>1'8"</b>
carry position	High Lift Boom	680 mm <b>2'3"</b>
D Ground clearance	455 mm	<b>1'6"</b>
E Hitch height	1150 mm	<b>3'9"</b>
F Overall height, top of the stack	3100 mm	<b>10'2"</b>
G Overall height, ROPS cab	3390 mm	<b>11'1"</b>

Measured with 23.5R25 (L3) tires, ROPS/FOPS cab

	Standard Boom				High Lift Boom
	General Purpose Bucket Pin On	General Purpose Bucket Pin On	Excavating Bucket Pin On	Excavating Bucket Pin On	General Purpose Bucket Pin On
	Bolt-on Cutting Edge	Teeth	Bolt-on Cutting Edge	Teeth	Bolt-on Cutting Edge
Bucket capacity: heaped	3.3 m <sup>3</sup> <b>4.3 yd<sup>3</sup></b>	3.1 m <sup>3</sup> <b>4.0 yd<sup>3</sup></b>	2.9 m <sup>3</sup> <b>3.8 yd<sup>3</sup></b>	2.7 m <sup>3</sup> <b>3.5 yd<sup>3</sup></b>	2.9 m <sup>3</sup> <b>3.8 yd<sup>3</sup></b>
struck	2.9 m <sup>3</sup> <b>3.8 yd<sup>3</sup></b>	2.7 m <sup>3</sup> <b>3.5 yd<sup>3</sup></b>	2.4 m <sup>3</sup> <b>3.1 yd<sup>3</sup></b>	2.3 m <sup>3</sup> <b>3.0 yd<sup>3</sup></b>	2.4 m <sup>3</sup> <b>3.1 yd<sup>3</sup></b>
Bucket width	2905 mm <b>9'6"</b>	2920 mm <b>9'7"</b>	2905 mm <b>9'6"</b>	2920 mm <b>9'7"</b>	2905 mm <b>9'6"</b>
Bucket weight	1610 kg <b>3,549 lb</b>	1540 kg <b>3,395 lb</b>	1720 kg <b>3,792 lb</b>	1650 kg <b>3,638 lb</b>	1720 kg <b>3,792 lb</b>
H Dumping clearance, max. height and 45° dump angle*	2950 mm <b>9'8"</b>	2815 mm <b>9'3"</b>	3045 mm <b>10'0"</b>	2910 mm <b>9'7"</b>	3575 mm <b>11'9"</b>
I Reach at max. height and 45° dump angle*	1150 mm <b>3'9"</b>	1265 mm <b>4'2"</b>	1045 mm <b>3'5"</b>	1160 mm <b>3'10"</b>	1185 mm <b>3'11"</b>
J Reach at 2130 mm 7' clearance and 45° dump angle*	1735 mm <b>5'8"</b>	1845 mm <b>6'1"</b>	1630 mm <b>5'4"</b>	1745 mm <b>5'9"</b>	2205 mm <b>7'3"</b>
K Reach with arm horizontal and bucket level*	2590 mm <b>8'6"</b>	2768 mm <b>9'1"</b>	2450 mm <b>8'1"</b>	2630 mm <b>8'8"</b>	2940 mm <b>9'8"</b>
L Operating height (fully raised)	5600 mm <b>18'4"</b>	5600 mm <b>18'4"</b>	5450 mm <b>17'11"</b>	5450 mm <b>17'11"</b>	5985 mm <b>19'8"</b>
M Overall length (bucket on ground)	8310 mm <b>27'3"</b>	8490 mm <b>27'10"</b>	8170 mm <b>26'10"</b>	8350 mm <b>27'5"</b>	8810 mm <b>28'11"</b>
Loader clearance circle (bucket at carry, outside corner of bucket)	14440 mm <b>47'5"</b>	14540 mm <b>47'8"</b>	14370 mm <b>47'2"</b>	14470 mm <b>47'6"</b>	14850 mm <b>48'9"</b>
Digging depth: 0°	60 mm <b>2"</b>	75 mm <b>3"</b>	60 mm <b>2"</b>	75 mm <b>3"</b>	110 mm <b>4"</b>
10°	290 mm <b>11"</b>	335 mm <b>13"</b>	265 mm <b>10"</b>	310 mm <b>12"</b>	320 mm <b>13"</b>
Static tipping load: straight	15440 kg <b>34,039 lb</b>	15545 kg <b>34,271 lb</b>	15335 kg <b>33,808 lb</b>	15435 kg <b>34,028 lb</b>	12055 kg <b>26,577 lb</b>
40° full turn	13440 kg <b>29,630 lb</b>	13540 kg <b>29,851 lb</b>	13325 kg <b>29,377 lb</b>	13430 kg <b>29,608 lb</b>	10407 kg <b>22,943 lb</b>
Breakout force	158 kN 16100 kgf <b>35,494 lbf</b>	170 kN 17300 kgf <b>38,140 lbf</b>	175 kN 17850 kgf <b>39,353 lbf</b>	190 kN 19335 kgf <b>42,626 lbf</b>	183 kN 18661 kgf <b>41,140 lbf</b>
Operating weight	18455 kg <b>40,686 lb</b>	18385 kg <b>40,532 lb</b>	18565 kg <b>40,929 lb</b>	18495 kg <b>40,774 lb</b>	19020 kg <b>41,932 lb</b>

\* At the end of tooth or B.O.C.E. (Bolt on cutting edge)  
All dimensions, weights, and performance values based on SAE J732c and J742b standards.

Static tipping load and operating weight shown include lubricant, coolant, full fuel tank, ROPS cab, and operator.  
Machine stability and operating weight affected by counterweight, tire size, and other attachments.



## WEIGHT CHANGES

Tires or attachments	Operating weight		Tipping load straight		Tipping load full turn	
	kg	lb	kg	lb	kg	lb
Remove additional counterweight	-325	-716	-840	-1852	-700	-1543



## STANDARD EQUIPMENT

- 2-spool valve for boom and bucket control
- Alternator, 90 A, 24 V
- Auto shift transmission with mode select system
- Automatic hydraulic-driven fan with automatic reverse rotation
- Back-up alarm
- Batteries, 140 Ah/12V (2), 930 CCA
- Battery disconnect
- Boom kick-out, in-cab adjustable
- Bucket positioner, in-cab adjustable, 3 positions
- Color rear view camera and monitor
- Counterweight, standard and additional
- Electronically Controlled Suspension System
- Engine, Komatsu SAA6D107E-3 diesel
- Engine shut-off system, electric
- EPC fingertip controls with F-N-R switch, two levers
- Equipment Management Monitoring System (EMMS)
  - Lights (central warning, brake oil pressure, engine oil pressure, parking brake, cooling fan reverse, KDPF restriction, seat belt caution, Komtrax message)
- Gauges (engine water temperature, ecology, fuel level, hydraulic oil, DEF level temperature, speedometer/tachometer)
  - Front fenders
  - Fuel pre-filter with water separator
  - Horn, electric
  - Komatsu SmartLoader Logic
  - Komatsu Auto Idle Shutdown
  - KOMTRAX® Level 5.0
  - Lift cylinders and bucket cylinder
  - Lights
    - Back-up light, LED
    - Stop and tail light, LED
    - Turn signal lamps, 2 front and 2 rear with hazard switch
    - Working lights, halogen, 2 front cab mount
    - Working lights, halogen, 2 front fender mount
    - Working lights, halogen, 2 rear grill mount
  - Loader linkage with standard lift arm
  - Lock-up torque converter
  - Parking brake, electric
  - Radiator, wider core
  - Radiator mask, swing out
  - Rear full fenders
  - Rear view mirrors, outside (2) inside (2)
  - Rims for 23.5-25 tires
- ROPS/FOPS Cab Level 2
  - 2 x DC12V electrical outlets
  - Ashtray
  - Auto air conditioner
  - Cigarette lighter, 24V
  - Color LCD/TFT multi-monitor
  - Cup holder
  - Floor mat
  - Operator seat, reclining, air suspension type, heated
  - Radio, AM/FM with AUX input jack
  - Rear defroster, electric
  - Windshield washer and wiper, front with intermittent
  - Windshield washer and wiper, rear
- Service brakes, wet disc type
- Starting motor, 5.5 kW
- Transmission, 4 forward and 4 reverse
- Vandalism protection kit, padlocks for battery box (2)



## OPTIONAL EQUIPMENT

- 3-spool valve with lever and piping
- Auxiliary steering (SAE)
- Cutting edge (bolt-on type)
- Engine pre-cleaner with extension
- High-lift boom
- Limited slip differential (F&R)
- Monolever loader control with transmission F-N-R switch
- Various tire options, radial and bias
- Various bucket options



*Note: All comparisons and claims of improved performance made herein are made with respect to the prior Komatsu model unless otherwise specifically stated.*