

KOMATSU®

WA500-7

Tier 4 Interim Engine

WA500

NET HORSEPOWER

OPERATING WEIGHT

BUCKET CAPACITY



PHOTOS MAY INCLUDE OPTIONAL EQUIPMENT

WA500

WALK-AROUND

WA500-7



Photos may include optional equipment

Courtesy of Machine.Market

WA500-7

Tier 4 Interim Engine

NET HORSEPOWER

353 HP @ 1900 rpm
263 kW @ 1900 rpm

OPERATING WEIGHT

74,626–75,453 lb
33850–34225 kg

BUCKET CAPACITY

6.8–8.2 yd³
5.2–6.3 m³



HIGH PRODUCTION WITH LOW FUEL CONSUMPTION

Large capacity torque converter with lock-up:

- Reduces fuel consumption
- Faster top speed
- Quick acceleration
- Lock-up in 2nd, 3rd and 4th gear

Komatsu SmartLoader Logic helps reduce fuel consumption with no decrease in production.

A powerful **Komatsu SAA6D140E-6 engine** provides a net output of 263 kW **353 HP** with 7% improved fuel consumption. This engine is EPA Tier 4 Interim and EU stage 3B emissions certified.

Komatsu Variable Geometry Turbocharger (KVGTT) uses a hydraulic actuator to provide optimum air flow under all speed and load conditions.

Komatsu Diesel Particulate Filter (KDPF) captures 90% of particulate matter and provides automatic regeneration that does not interfere with daily operation.

Increased cooling capacity

- Auto-reversing fan is standard
- Wider core coolers

An all new **cab** provides the operator with improved comfort and visibility.

New high resolution monitor panel

- Enhanced and intuitive on-board diagnostics
- Integrated with KOMTRAX Level 4
- Integrated with Komatsu Tier 4 technology

Rearview monitoring system (standard)

New high capacity air suspension seat

- Seat mounted EPC controls with F-N-R switch
- Seat heater is standard

Energy saving guidance

- Six operator guiding messages
- Enhanced eco-gauge

Komatsu Auto Idle Shutdown helps reduce idle time and reduce operating costs.



Remote boom and bucket positioners can set kick-outs from inside the cab.

Variable displacement piston pumps with CLSS help reduce fuel consumption.

KOMTRAX®

Komtrax equipped machines can send location, SMR and operation maps to a secure website utilizing wireless technology. Machines also relay error codes, cautions, maintenance items, fuel levels, and much more.

HIGH PRODUCTIVITY & LOW FUEL CONSUMPTION

WA500-7

High Performance Komatsu SAA6D140E-6 Engine

The Komatsu SAA6D140E-6 engine is EPA Tier 4 Interim and EU Stage 3B emissions certified and provides exceptional performance while reducing fuel consumption. Based on Komatsu proprietary technologies developed over many years, this new diesel engine reduces exhaust gas particulate matter (PM) by more than 90% and nitrogen oxides (NOx) by more than 45% when compared to Tier 3 levels.

Through the in-house development and production of engines, electronics, and hydraulic components, Komatsu has achieved great advancements in technology, providing high levels of performance and efficiency in virtually all applications. The operator will notice high torque at low speeds, excellent operation and low fuel consumption to provide maximum productivity.



Komatsu Diesel Particulate Filter (KDPF)

Komatsu has developed a high efficiency diesel particulate filter that captures more than 90% of particulate matter. Both passive and active regeneration are automatically initiated by the engine controller depending on the soot level of the KDPF. A special oxidation catalyst with a fuel injection system is used to oxidize and remove particulate matter while the machine is running so the regeneration process will not interfere with daily operation.

The operator can also initiate regeneration manually or disable regeneration depending on the work environment.

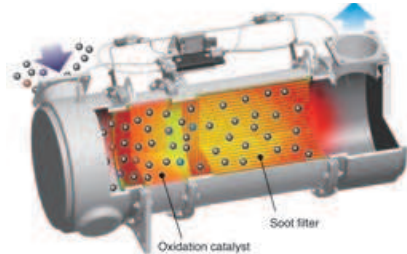

Closed Crankcase Ventilation (CCV)

Crankcase emissions (blow-by gas) are passed through a CCV filter. The CCV filter traps oil mist which is returned back to the crankcase while the gas, which is almost oil mist free, is fed back to the air intake.



Heavy Duty High Pressure Common Rail (HPCR) Fuel Injection System

The heavy duty HPCR system is electronically controlled to deliver a precise quantity of pressurized fuel into the combustion chamber using multiple injection events to achieve complete fuel burn and reduce exhaust gas emissions. Fuel injector reliability has been improved by using ultra-hard wear resistant materials.

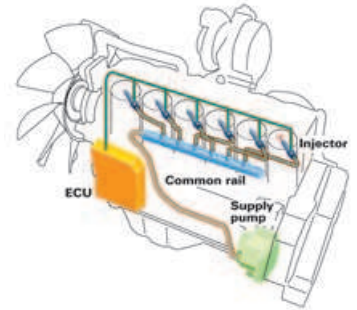

Komatsu Variable Geometry Turbocharger (KVTG)

Using Komatsu proprietary technology, a newly designed variable geometry turbocharger with a hydraulic actuator is used to manage and deliver optimum air flow to the combustion chamber under all speed and load conditions. The robust hydraulic actuator provides power and precision, resulting in cleaner exhaust gas, quick acceleration and improved fuel economy while maintaining performance.

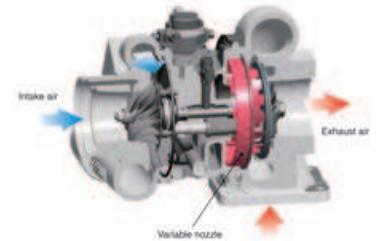

Redesigned Combustion Chamber

The combustion chamber located at the top of the engine piston has a new shape designed to improve combustion and further reduce NOx, PM, fuel consumption, and noise levels.

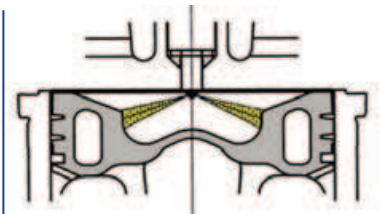

Cooled Exhaust Gas Recirculation (EGR)

Cooled EGR, a technology that has been well proven in Komatsu Tier 3 engines, reduces NOx emissions to meet Tier 4 levels. The hydraulically actuated EGR system has increased capacity and uses larger and more robust components to ensure reliability for demanding work conditions.

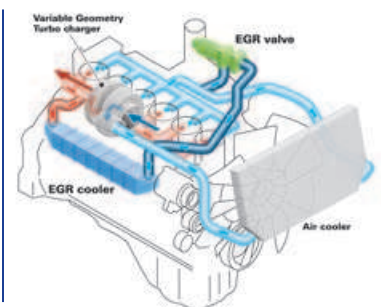

Advanced Electronic Control System

The engine control system has been upgraded to effectively manage the air flow rate, EGR gas flow rate, fuel injection parameters, and aftertreatment functions. The new control system also provides enhanced diagnostic capabilities.

Komatsu SmartLoader Logic

The WA500-7 provides Komatsu SmartLoader Logic, a new engine control system. This technology acquires data from various sensors in the vehicle and controls the engine to yield enough torque for each work phase. Engine torque requirements for a wheel loader vary depending on working conditions. For example, the loader requires higher torque for digging in V-shape loading, but less torque when traveling with an empty bucket. This technology limits the engine torque during less demanding work, therefore saving fuel. Komatsu SmartLoader Logic functions automatically and doesn't interfere with operation, saving fuel without decreasing production.

Large-Capacity Torque Converter

The WA500-7 power train has a large capacity torque converter for optimum efficiency. The WA500-7 has greater productivity in V-shape loading applications because the increased tractive effort does not require full throttle. The improved hill climbing ability allows the WA500-7 to up-shift gears faster because of improved acceleration. The WA500-7 can achieve higher gear ranges and maintain higher travel speed when working in load-and-carry applications. In most applications, production is increased and fuel consumption is reduced, resulting in improved fuel efficiency.

Enhanced Lock-Up

The large-capacity torque converter with lock-up is standard on the WA500-7. The lock-up function activates in 2nd, 3rd and 4th gears to give the loader a maximum travel speed of 37.3 km/h **23.2 mph**. The large capacity torque converter with enhanced lock-up is effective for both load and carry applications, and V-shape loading which uses lower gears. The enhanced lock-up reduces the clutch engagement shock by controlling engine torque with Komatsu SmartLoader Logic improving operator comfort. The enhanced lock-up combined with Komatsu SmartLoader Logic results in lower fuel consumption and higher travel speeds in load and carry and even some cycle loading applications.

Komatsu Auto Idle Shutdown

In order to reduce idle time, Komatsu offers Komatsu Auto Idle Shutdown. This function will shut the engine off and apply the parking brake and hydraulic lock after a preset idle time limit. This time limit can be set by the operator or service technician and may range from 3 minutes to 60 minutes.

Low Fuel Consumption

Komatsu added many new features on the WA500-7 to reduce fuel consumption. These features enable further fuel efficiency by optimally controlling engine power and matching the Komatsu designed and produced high efficiency power train components and hydraulic system.

7% Reduction in Fuel consumption

* Compared with the WA500-6, fuel consumption varies depending on working conditions.

Dual-Mode Engine Power Select System

This wheel loader offers two selectable operating modes—E and P.

- **E Mode:** This mode provides maximum fuel efficiency for general loading.
- **P Mode:** This mode provides maximum power output for hard digging operations or hill climb applications.



Dual mode engine power selection switch

Eco-Guidance

The Eco-guidance provides information on the monitor to help save fuel. The monitor displays messages in real-time during operation and on the exit screen when turning the key to shut off the engine. This function can be controlled through the monitor. The operator can view Eco-guide and fuel consumption through the monitor as well as through KOMTRAX.

During operation



User menu for ON/OFF setting



Key OFF



Variable Displacement Piston Pump & CLSS

The variable displacement piston pump combined with the Closed-center Load Sensing System (CLSS) delivers as much hydraulic flow as the job requires, preventing wasted hydraulic flow. Minimized loss contributes to better fuel economy.

New Designed Cabin

The new cabin offers better ergonomics, more storage space and more features to improve operator comfort.



WA500-7

Operator Seat with EPC (Electronic Pilot Control) Levers

The work equipment control system has an EPC lever console integrated into the higher capacity seat and moves with the seat. The angle of the armrest is fully adjustable for optimum operator comfort. An F-N-R switch is now incorporated in the console. A heated seat is now standard.



Tiltable / Telescopic Steering Wheel

The WA500-7 comes standard with a tiltable and telescopic steering wheel that can be pushed up and out of the way for easy entry and exit of the cab.



Low Noise Design

Operator's ear noise level : 73 dB(A)

Dynamic noise level (outside): 111 dB(A)

The large cab is mounted with Komatsu's unique ROPS/FOPS viscous mounts. The low-noise engine, hydraulically driven fan, and hydraulic pumps are mounted with rubber cushions, and the cab sealing is designed to provide a quiet, low-vibration, dustproof, and comfortable operating environment.

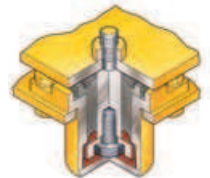

Increased Cab Storage Area

The WA500-7 cab features a storage box on the left hand side of the cab to allow the operator to store items out of the way. A hot or cold box on the right hand side of the cab allows the operator to keep a beverage or lunch warm or cold, depending on the season.



Ergonomic Comfort

The dashboard and cab have been redesigned to improve operator comfort. The monitor can be controlled by the multi-switch panel. Also, the front glass of the cab has been lowered to improve visibility.



Rear View Monitoring System (standard)

The operator can view the rear of the machine with a full color monitor that is located on the right side of the cab. This monitor can be always on or only on when the loader goes into reverse. Visual guidelines can also be added for more convenience.



Seat Belt Caution Indicator

A warning indicator appears on the monitor when the seat belt is not engaged.



Engine Shutdown Secondary Switch

The engine stop switch is incorporated to allow shutdown of the machine when accessing the key switch is not possible.

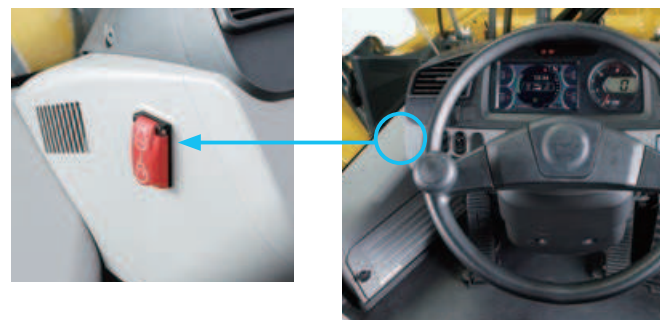

Auxiliary Input (MP3 Jack) 12 V Outlets

An Aux input to allow use of an MP3 player or other device is now standard as well as two 12 volt outlets. These are all located on the front of the right hand console.

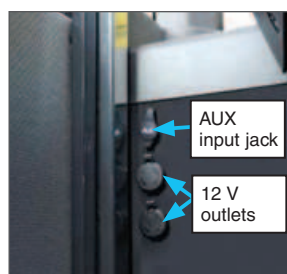



Easy Entry and Egress

The WA500-7 provides an inclined ladder with wide steps and hand holds. The door latch can be reached from ground level to ease opening and closing the door.

Remote Bucket & Boom Positioner

The operator can set the bucket angle and remote boom positioner from the cab. Both upper and lower boom positions are adjustable in the cab with the push of a button.



Remote positioner switch
Boom / Bucket

Automatic Kick-down

The WA500-7 has the ability to automatically shift down to F1. This can be activated through the monitor.



Kick-down switch

Electronically Controlled Suspension System (ECSS)

The Electronically Controlled Suspension System (ECSS) or ride control system uses an accumulator which absorbs some of the shock in the boom arm, giving the operator a much smoother ride. This reduces operator fatigue and reduces material spillage during load and carry operations. ECSS is speed sensitive, meaning that the boom won't move during stationary digging. ECSS is standard on the WA500-7.

INFORMATION & COMMUNICATION TECHNOLOGY

Machine Monitor

The machine monitor displays various machine information and allows for various settings of the machine.

Large Multi-Lingual LCD Monitor

A large user-friendly color monitor provides excellent screen visibility through the use of a TFT liquid crystal display that can easily be read at various angles and lighting conditions. A keypad provides simple and easy navigation to machine operation information.

Switch panel

The switch panel is used to select various LCD unit screens and the air conditioner control screen.

By using the switch panel, you can display various user menus on the LCD unit screen and perform the settings of the machine.

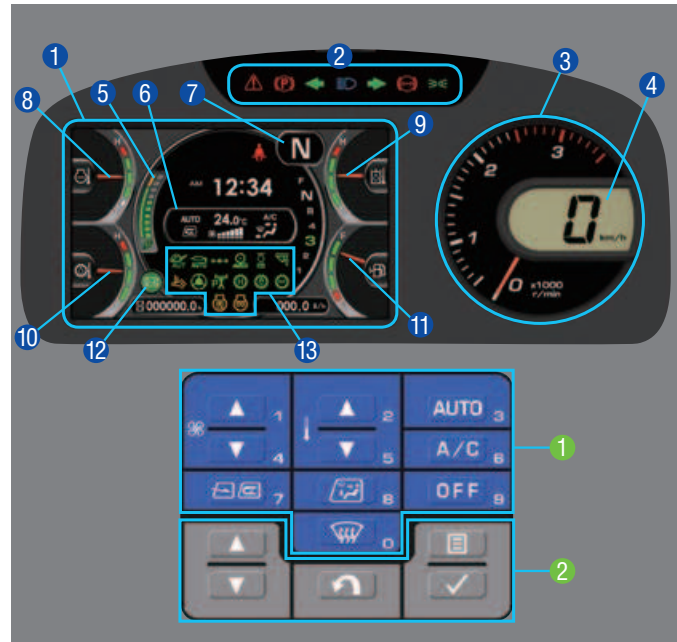

Machine monitor

- 1 LCD unit
- 2 LED unit
- 3 Engine tachometer
- 4 Speedometer
- 5 ECO gauge
- 6 Air conditioner display
- 7 Shift indicator
- 8 Engine coolant temperature gauge
- 9 Hydraulic oil temperature gauge
- 10 Torque converter oil temperature gauge
- 11 Fuel gauge
- 12 Message pilot lamp
- 13 Pilot lamps

Switch panel

- 1 Air conditioner switches / Numeral key pad
- 2 Function switches



1 ECO Guidance

- Operation Records
- ECO guidance Records
- Average Fuel Consumption Logs
- Configurations

2 Machine setting / information

- Radiator fan reverse mode
- CAC fan reverse mode
- TCS setting etc.

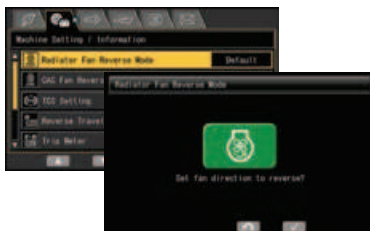

3 KDPF regeneration

- Setting for regeneration stop
- Operation of manual stationary regeneration

4 Maintenance

- Check and reset of various maintenance intervals

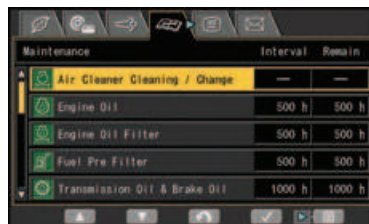

5 Monitor setting

- 25 Languages
- Rear view monitor setting
- Meter select
- Screen adjustments





Photos may include optional equipment

WA500-7

Full Side-Opening Gull-Wing Engine Doors

The large gull-wing type engine doors are operated with low effort assisted by gas springs. The doors open in two steps. The first position is for daily maintenance and the second position is for periodic maintenance. Large steps are provided on each side of the frame to help access.



Photos may include optional equipment

Swing Out Fan

The large capacity cooling unit features a wider spacing of the cooling fins to reduce clogging. The hydraulic driven cooling fan can be opened for cleaning.



Photos may include optional equipment

Auto Reversing Fan

The engine cooling fan is driven hydraulically. It can be set to reverse automatically during operation. Fan reverse mode and timing can be controlled through the monitor.



Maintenance Function

The monitor informs the operator when the replacement interval for oil and filters will be reached.



Battery Disconnect

The battery disconnect switch is located on the side of the right side battery box. This can be used to disconnect power when performing service work on the machine.



Engine Compartment

The WA500-7 engine compartment was laid out for easy serviceability. Great attention was paid to the location of the maintenance items, such as the filters, dipsticks and oil fill locations. The same goes for the KDPF and CCV filter, as even the top of the hood was redesigned to ease removal of the KDPF for cleaning or replacement.



KDPF Regeneration

Soot trapped by and accumulated in the KDPF is removed by burning it periodically and automatically.



KDPF regeneration indicator

Manual Stationary Regeneration

Under most conditions, active regeneration will occur automatically with no effect on machine operation. In case the operator needs to disable active regeneration or initiate a manual stationary regeneration, this can be easily accomplished through the monitor panel.

A soot level indicator is displayed to show how much soot is trapped in the KDPF.



Soot level indicator

LED Taillights

LED tail lamps / brake lamps and reverse lamps provide long bulb life and use less power than the ones on the WA500-6.



Cab Air Intake Filter

The cab air intake filter is located on the front of the cab, on the left hand side of the machine behind a lockable door, for easy access and security.



KOMTRAX EQUIPMENT WORKING ENVIRONMENT MONITORING



KOMTRAX is Komatsu's remote equipment monitoring and management system. KOMTRAX gathers critical machine and operation information and provides it in a user-friendly format so that you can make well-informed decisions. KOMTRAX gives you more control of your equipment and better control of your business!

KOMTRAX comes standard on all new Komatsu machines with complimentary manufacturer communications services throughout the entire ownership period. It is a powerful tool and makes Komatsu machines an even better purchase!

Fleet Optimization

KOMTRAX tells you how your machines and operators are performing. KOMTRAX provides:

- Fuel consumption data and trends, by unit or fleet
- Machine fuel level
- Machine utilization
- Actual working hours/Machine idle hours
- Attachment usage hours
- Machine travel hours
- Machine load analysis
- Operating mode ratios

Location and Asset Management

KOMTRAX tells you where your machines are and can help prevent unauthorized use. KOMTRAX provides:

- GPS location/Operation maps
- Out-of-area and movement alert with location and time
- Engine, nighttime, and calendar lock

Maintenance Management

KOMTRAX monitors the health of your machines and provides critical information so that you, and your distributor, can take proactive maintenance measures and reduce downtime. KOMTRAX provides:

- Service Meter Reading (SMR)
- Cautions/Abnormality codes
- Maintenance replacement notifications

Easy and Flexible Access to Information

With KOMTRAX, information about your machines is available through a convenient, internet-based portal. KOMTRAX provides:

- A user-friendly KOMTRAX website with customized access to your machine information
- E-mail and text alerts
- Web dial-up service
- Monthly fleet summary reports

For more information, including terms and conditions of the manufacturer complimentary KOMTRAX communication service, ask your distributor, pick up a KOMTRAX brochure, or go to www.komatsuamerica.com/komtrax.

KOMTRAX®

For construction and compact equipment.

KOMTRAX Plus®

For production and mining class machines.

KOMATSU PARTS & SERVICE SUPPORT



Komatsu is an industry leader in building reliable and technologically advanced machines. It is only fitting that we would provide superior Product Support. Komatsu and its distributors are focused on providing their customers unparalleled Product Support throughout the entire lifecycle of the machine. It's called Komatsu CARE.

Komatsu CARE – Complimentary Scheduled Maintenance

Komatsu remains focused on lowering the customer's ownership costs by engineering machines with increased fuel efficiency and productivity. In addition, one Komatsu CARE program aimed at further reducing your owning and operating costs is Complimentary Scheduled Maintenance. Komatsu machine owners can now rely on their Komatsu Distributor to perform the preventative maintenance on their Komatsu Tier 4 machines.

- Complimentary scheduled maintenance for the earlier of 3 years or 2,000 hours is standard on all Komatsu Tier 4 construction machines and is available at all distributors in the U.S. and Canada.
- Service is performed by factory certified technicians using only Komatsu Genuine parts and fluids
- Significantly lowers your cost of ownership while maintaining high equipment uptime and reliability
- Increases resale value and provides detailed maintenance records

Komatsu CARE – Extended Coverage

Komatsu equipment is built to withstand harsh operating environments, but our Extended Coverage can provide further peace of mind by protecting customers from unplanned expenses and impacts in cash flow. Purchasing Komatsu CARE's Extended Coverage locks-in the cost of covered parts and labor for the extended warranty period and helps to turn these variable expenses into a fixed cost.

- No Stop Loss or Loss Limits imposed, regardless of the coverage type or repair expense
- Any combination of months and hours out to five years and 10,000 engine hours – KOWA kits included
- Coverage premium can be rolled into the machine financing at time of sale or purchased any time before the expiration of the machine's standard warranty
- Coverage is fully transferable and honored by all Komatsu distributors throughout the U.S. and Canada

Komatsu CARE – Total CARE

Total CARE combines the benefits of the Komatsu CARE Scheduled Maintenance and Extended Coverage programs on your Tier 4 machine. This ensures the use of Komatsu genuine parts and fluids during regular maintenance intervals as well as highly skilled and efficient technicians to perform any other warranty repair work that might be necessary to keep your Komatsu equipment running like new.

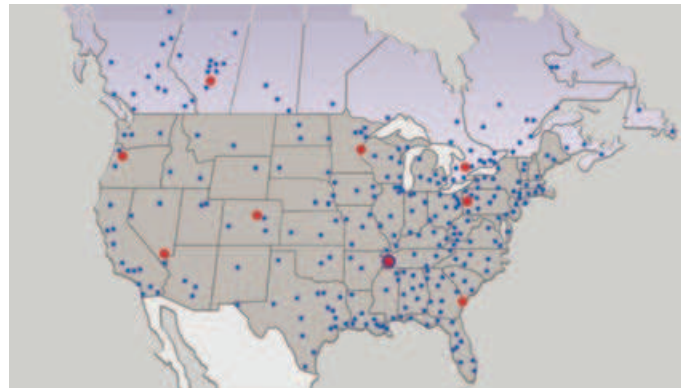

Komatsu Parts Support

Because downtime can be costly, Komatsu maintains a strategic distribution network throughout the U.S. and Canada, to ensure superior parts availability and to keep your Komatsu machine up and running.

- Komatsu America has nine Parts Distribution Centers strategically located throughout the U.S. and Canada
- Komatsu America's Parts distribution network is accessible 24/7/365 to fulfill your parts needs
- Komatsu has a distributor network of over 325 locations across the U.S. and Canada
- Online parts ordering available through Komatsu eParts, 24/7/365. (See distributor for details)
- Komatsu offers a full line of factory Remanufactured products with same-as-new warranties at a significant cost reduction:
 1. Complete Engine Assemblies
 2. Transmissions
 3. Torque Converters
 4. Hydraulic components
 5. Starters, Alternators, turbochargers and circuit boards

Komatsu Oil and Wear Analysis (KOWA)

The KOWA program uses independent laboratories across the United States to determine how your machine is performing based on a small sample of oil or other fluid. Just like a doctor will take a blood test to check on your personal health, KOWA allows you to check how your equipment is performing. Used with PM Clinic and PM Tune Up, KOWA is one of your best tools for proactively maintaining your Komatsu equipment and maximizing its availability and performance.

KOWA detects fuel dilution and coolant leaks, identifies contaminants, and measures wear-metals. Your distributor will help you interpret this information so you can identify potential problems and head them off before they lead to major repairs.

For more information of all of the manufacturer sponsored programs mentioned in this brochure, including terms and conditions of the individual programs, please speak with your distributor or go to www.komatsuamerica.com

SPECIFICATIONS

WA500-7



ENGINE

Model..... Komatsu SAA6D140E-6*
 Type..... Water-cooled, 4-cycle
 Aspiration..... Turbo-charged, after-cooled, cooled EGR
 Number of cylinders..... 6
 Bore..... 140 mm **5.51"**
 Stroke..... 165 mm **6.50"**
 Piston displacement..... 15.24 ltr **930 in³**
 Governor..... All-speed, electronic
 Horsepower:
 SAE J1995..... Gross 266 kW **357 HP**
 ISO 9249 / SAE J1349..... Net 263 kW **353 HP**
 Rated rpm..... 1900 rpm
 Fan drive method for radiator cooling..... Hydraulic
 Fuel system..... Direct injection
 Lubrication system:
 Method..... Gear pump, force-lubrication
 Filter..... Full-flow type
 Air cleaner..... Dry type with double elements and dust evacuator, plus dust indicator

*EPA Tier 4 Interim and EU stage 3B emissions certified



TRANSMISSION

Torque converter..... 3-elements, 1-stage, 2-phase
 Transmission..... Full-powershift, planetary type

Travel speed	Forward*	Reverse*
1st	7.5 km/h 4.7 mph	8.5 km/h 5.3 mph
2nd	12.9 km/h 8.0 mph (13.1 km/h 8.1 mph)	12.9 km/h 8.0 mph (13.0 km/h 8.1 mph)
3rd	22.2 km/h 13.8 mph (23.7 km/h 14.7 mph)	24.7 km/h 15.3 mph (26.6 km/h 16.5 mph)
4th	35.5 km/h 22.1 mph (37.3 km/h 23.2 mph)	38.0 km/h 23.6 mph (38.0 km/h 23.6 mph)

*P-mode Measured with 29.5-25 tires (): Lock-up clutch ON



AXLES AND FINAL DRIVES

Drive system..... Four-wheel drive
 Front..... Fixed, full-floating
 Rear..... Center-pin support, full-floating, 24° total oscillation
 Reduction gear..... Spiral bevel gear
 Differential gear..... Conventional type
 Final reduction gear..... Planetary gear, single reduction



BRAKES

Service brakes..... Hydraulically actuated, wet disc brakes actuate on four wheels
 Parking brake..... Wet disc brake
 Emergency brake..... Parking brake is commonly used



STEERING SYSTEM

Type..... Articulated type, fully-hydraulic power steering
 Steering angle..... 36° (40° to max end stop)
 Minimum turning radius at the center of outside tire..... 7050 mm **23' 2"**



HYDRAULIC SYSTEM

Steering system:
 Hydraulic pump..... Piston type
 Capacity..... 120 ltr/min **31.7 U.S. gal/min** at rated rpm
 Relief valve setting..... 24.5 MPa 250 kgf/cm² **3,555 psi**
 Hydraulic cylinders:
 Type..... Double-acting, piston type
 Number of cylinders..... 2
 Bore x stroke..... 100 mm x 486 mm **3.9" x 19.1"**

Loader control:
 Hydraulic pump..... Piston pump
 Capacity..... 320 ltr/min **84.8 U.S. gal/min** at rated rpm
 Relief valve setting..... 34.3 MPa 350 kgf/cm² **4,980 psi**
 Hydraulic cylinders:
 Type..... Double-acting, piston type
 Number of cylinders—bore x stroke:
 Boom cylinder..... 2- 160 mm x 898 mm **6.3" x 35.4"**
 Bucket cylinder..... 1- 185 mm x 675 mm **7.3" x 26.6"**
 Control valve..... 2-spool type
 Control positions:
 Boom..... Raise, hold, lower, and float
 Bucket..... Tilt-back, hold, and dump
 Hydraulic cycle time (rated load in bucket)
 Raise..... 7.2 s
 Dump..... 1.7 s
 Lower (Empty)..... 4.2 s



SERVICE REFILL CAPACITIES

Cooling system..... 133 ltr **35.1 U.S. gal**
 Fuel tank..... 473 ltr **124.9 U.S. gal**
 Engine..... 37 ltr **9.8 U.S. gal**
 Hydraulic system..... 337 ltr **89.0 U.S. gal**
 Axle (each front and rear)..... 95 ltr **25.1 U.S. gal**
 Torque converter and transmission..... 71 ltr **18.8 U.S. gal**



BUCKET SELECTION GUIDE

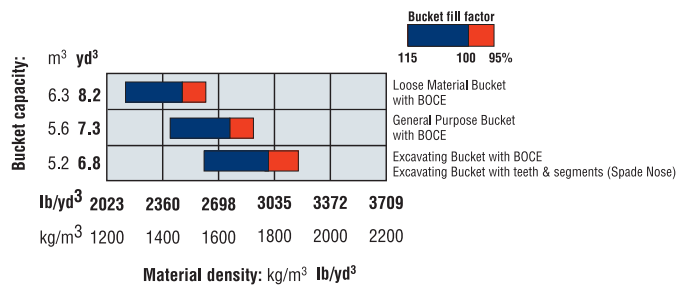



DIMENSIONS

Measured with 29.5-25-22PR (L3) tires

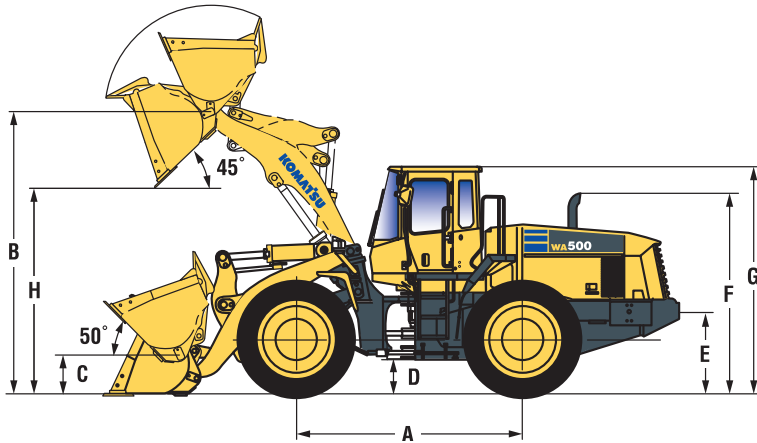

Tread	2400 mm	7'10"
Width over tires	3190 mm	10'6"
A Wheelbase	3780 mm	12'5"
B Hinge pin height, max. height	4755 mm	15'7"
C Hinge pin height, carry position	575 mm	1'11"
D Ground clearance	450 mm	1'6"
E Hitch height	1115 mm	3'8"
F Overall height, top of the stack	3665 mm	12'0"
G Overall height, ROPS cab	3785 mm	12'5"

	General Purpose Bucket	Excavating Bucket	Loose Material Bucket
	Straight Edge Bolt-on Cutting Edge	Straight Edge Bolt-on Cutting Edge	Straight Edge Bolt-on Cutting Edge
Bucket capacity: heaped	5.6 m ³	5.2 m ³	6.3 m ³
	7.3 yd³	6.8 yd³	8.2 yd³
struck	4.8 m ³	4.2 m ³	5.3 m ³
	6.3 yd³	5.5 yd³	6.9 yd³
Bucket width	3400 mm	3400 mm	3400 mm
	11'2"	11'2"	11'2"
Bucket weight	3110 kg	3055 kg	3485 kg
	6,855 lb	6,735 lb	7,683 lb
Dumping clearance, max. height and 45° dump angle* (H)	3295 mm	3395 mm	3210 mm
	10'10"	11'2"	10'6"
Reach at max. height and 45° dump angle*	1500 mm	1400 mm	1585 mm
	4'11"	4'7"	5'2"
Reach at 2130 mm 7" clearance and 45° dump angle*	2300 mm	2215 mm	2350 mm
	7'7"	7'3"	7'8"
Reach with arm horizontal and bucket level*	3265 mm	3120 mm	3385 mm
	10'9"	10'3"	11'11"
Operating height (fully raised)	6430 mm	6415 mm	6540 mm
	21'1"	21'1"	21'5"
Overall length	9915 mm	9770 mm	10035 mm
	32'6"	32'1"	32'11"
Loader clearance circle (bucket at carry, outside corner of bucket)	16440 mm	16360 mm	16500 mm
	53'11"	53'8"	54'1"
Digging depth: 0°	135 mm	135 mm	135 mm
	5"	5"	5"
	10°	435 mm	410 mm
	1'5"	1'4"	1'6"
Static tipping load: straight	27140 kg	27180 kg	26850 kg
	59,833 lb	59,922 lb	59,194 lb
	40° full turn	24580 kg	24620 kg
	54,190 lb	54,278 lb	53,550 lb
Breakout force	245 kN	268 kN	227 kN
	25000 kgf	27300 kgf	23200 kgf
	55,115 lb	60,185 lb	51,150 lb
Operating weight	34750 kg	34705 kg	35125 kg
	76,611 lb	76,511 lb	77,437 lb

* At the end of B.O.C.E.

All dimensions, weights, and performance values based on SAE J732c and J742b standards.

Static tipping load and operating weight shown include lubricant, coolant, full fuel tank, additional counterweight, ROPS cab, air conditioning unit, Electronically Controlled Suspension System (ECCS) and operator.

Machine stability and operating weight affected by tire size, and other attachments.



WEIGHT CHANGES

Tires or attachments	Operating weight		Tipping load straight		Tipping load full turn	
	kg	lb	kg	lb	kg	lb
Remove additional counterweight	-900	-1984	-1990	-4387	-1720	-3792



STANDARD EQUIPMENT

- 2-spool valve for boom and bucket control
- Alternator, 90 A
- Auto shift transmission with mode select system
- Automatic hydraulic-driven fan with automatic reverse rotation
- Back-up alarm
- Batteries, 160 Ah/12 V (2)
- Battery disconnect
- Boom Kick-out, in-cab adjustable
- Bucket Positioner, in-cab adjustable, 3 positions
- Color rear view camera and monitor
- Counterweight, standard and additional
- Electronically Controlled Suspension System (ECSS)
- Engine, Komatsu SAA6D140E-6 diesel
- Engine shut-off system, electric
- EPC fingertip controls with F-N-R switch, two levers
- Equipment Management Monitoring System (EMMS)
 - Lights (central warning, brake oil pressure, engine oil pressure, parking brake, cooling fan reverse, KDPF restriction, seat belt caution, Komtrax message)
- Gauges (Engine water temperature, ECO, Fuel level, Hydraulic oil temperature, speedometer/tachometer)
- Front fenders
- Front window washer and wiper, intermittent
- Fuel pre-filter with water separator
- Komatsu SmartLoader Logic
- Komatsu Auto Idle Shutdown
- KOMTRAX® Level 4
- Lift cylinders and bucket cylinder
- Lights
 - Back-up light, LED
 - Stop and tail light, LED
 - Turn signal, 2 front and 2 rear with hazard switch
 - Working lights, halogen, 2 front cab mount
 - Working lights, halogen, 2 front fender mount
 - Working lights, halogen, 2 rear grill mount
- Loader linkage with standard lift arm
- Lock-up torque converter
- Radiator, wider core
- Radiator mask, lattice type
- Rear view mirrors, outside (2) inside (2)
- Rims for 29.5-25 tires
- ROPS/FOPS Cab Level 2
 - 2 x DC12V electrical outlets
 - Ashtray
 - Auto air conditioner
 - Cigarette lighter
 - Color LCD/TFT multi-monitor
 - Cup holder
 - Floor mat
 - Operator seat, reclining, air suspension type, heated
 - Radio, AM/FM with AUX input jack
 - Rear defroster, electric
 - Seatbelt, 2-point retractable, 76mm 3" width
 - Space for Lunch box
 - Steering wheel, tilt and telescopic
 - Sun visor, front window
 - Windshield washer and wiper, front with intermittent
 - Windshield washer and wiper, rear
- Service brakes, wet disc type
- Starting motor, 11 kW
- Transmission, 4 forward and 4 reverse
- Vandalism protection kit



OPTIONAL EQUIPMENT

- Auxiliary steering (SAE)
- Limited slip differential (F&R)

WA500-7

