

# Mobile Crane Grue mobile

# LTM 1300-6.2

Technical Data  
Caractéristiques techniques

**New • Nouveau**

**Preliminary  
Préliminaire**



# LIEBHERR

Courtesy of Crane.Market

# Table of content

## Tables des matières

### Technical Data

Dimensions	3
Boom/jib combinations	4 – 6
Weights, Working speeds	7
Lifting capacities T	8 – 12
Lifting capacities TK	13 – 29
Lifting capacities TNZK	30 – 46
Lifting capacities TF	47 – 56
Lifting capacities TN	57 – 73
Equipment	74
Description of symbols	76
Remarks referring to load charts	77

### Caractéristiques techniques

Encombrement	3
Configurations de flèche	4 – 6
Poids, Vitesses	7
Forces de levage T	8 – 12
Forces de levage TK	13 – 29
Forces de levage TNZK	30 – 46
Forces de levage TF	47 – 56
Forces de levage TN	57 – 73
Equipement	75
Explication des symboles	76
Remarques relatives aux tableaux des charges	77

# Dimensions Encombrement

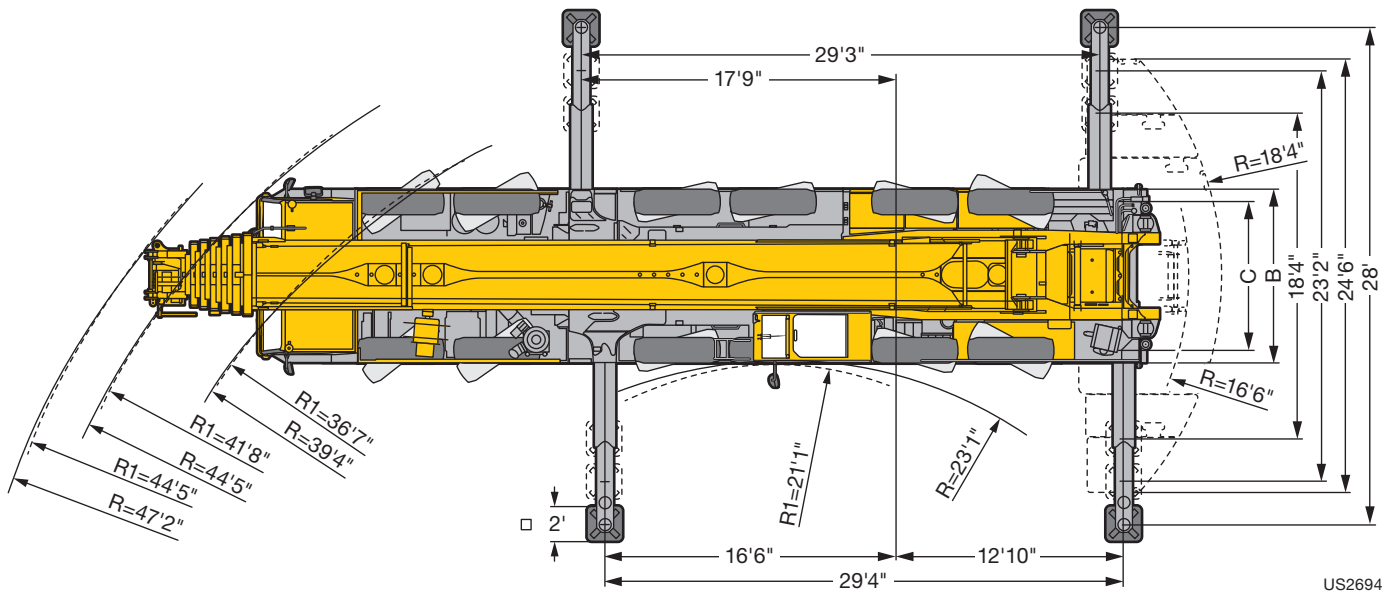
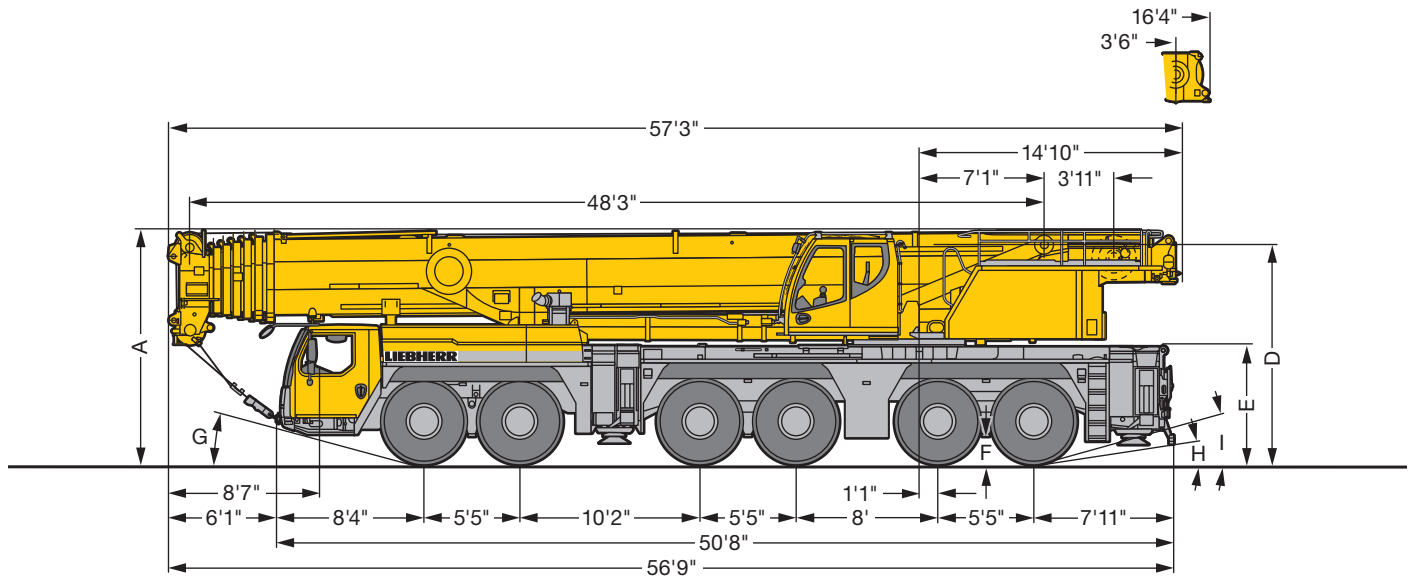

US2694

R<sub>1</sub> = All wheel steering · Direction toutes roues

Dimensions · Encombrement										
	A	A	B	C	D	E	F	G	H	I
445/95 R 25 (16.00 R 25)	13'1"	12'9" 5"	9'10"	8'4"	12'3"	6'7"	1'4"	14°	8°	15°
525/80 R 25 (20.5 R 25)	13'1"	12'9"	10'2"	8'5"	12'3"	6'7"	1'4"	14°	8°	15°

\* lowered · abaissé

## Boom/jib combinations Configurations de flèche

**T** Telescopic boom · Flèche télescopique

**K** Mechanical swing away jib  
Fléchette pliante mécanique

**NZK** Hydraulic swing away jib  
Fléchette pliante hydraulique

**F** Fixed lattice jib · Fléchette treillis fixe

**N** Luffing fly jib  
Fléchette treillis à volée variable



**T**

8 – 12

**TK/TNZK**

13 – 46

**TF**

47 – 56

**TN**

57 – 73



S2729

# Boom/jib combinations - Luffing fly jib Configurations de flèche - Fléchette à volée variable

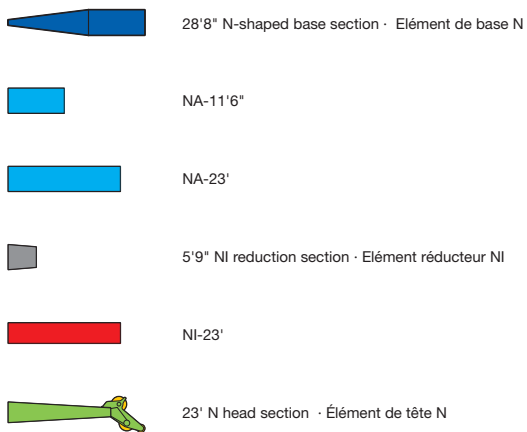
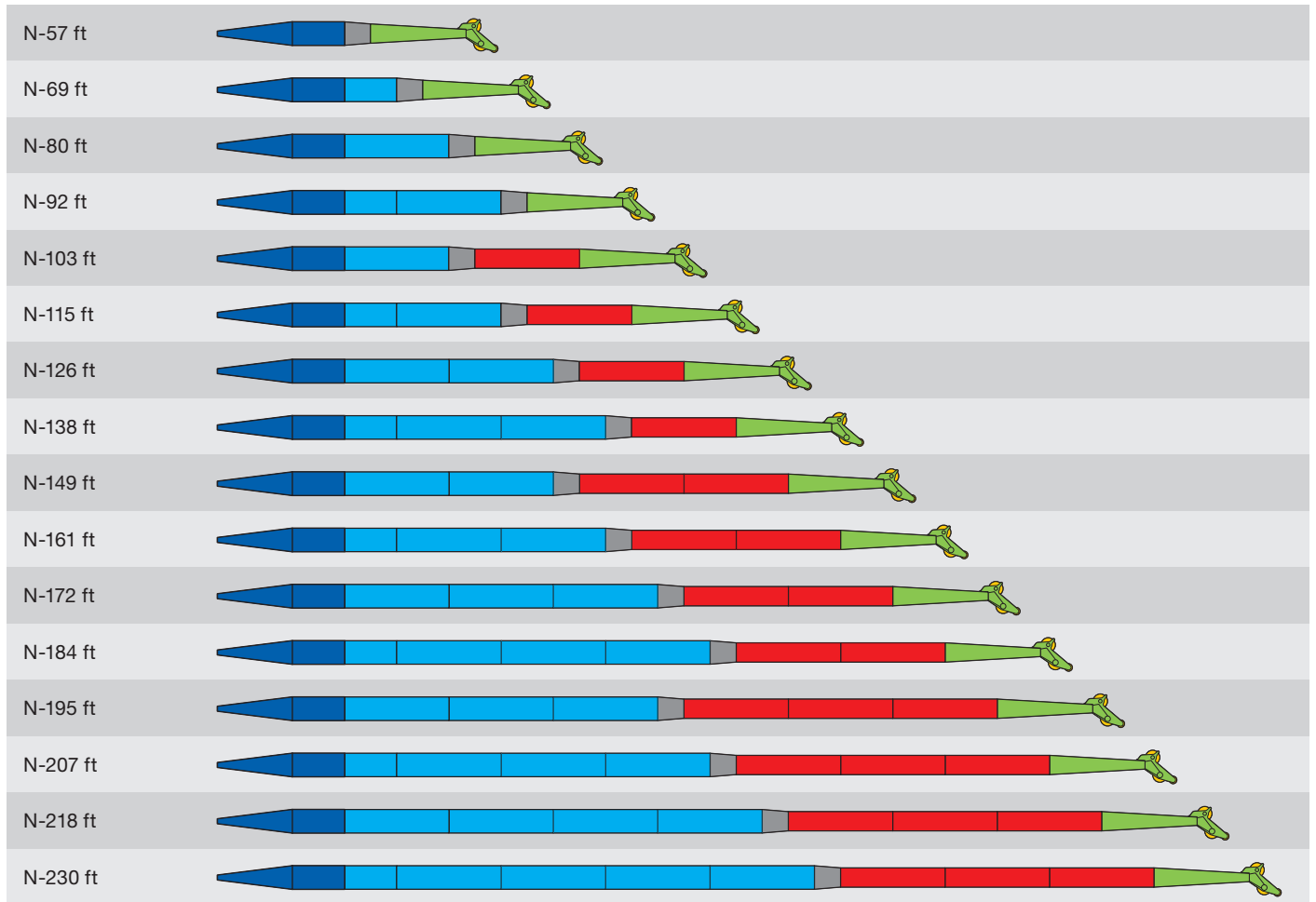

US2750

# Boom/jib combinations - Fixed fly jib Configurations de flèche - Fléchette fixe

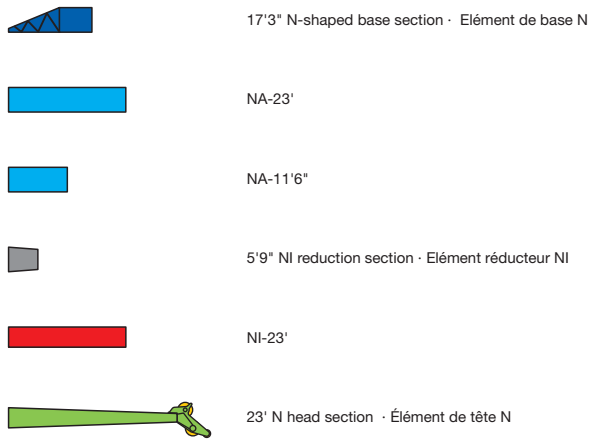
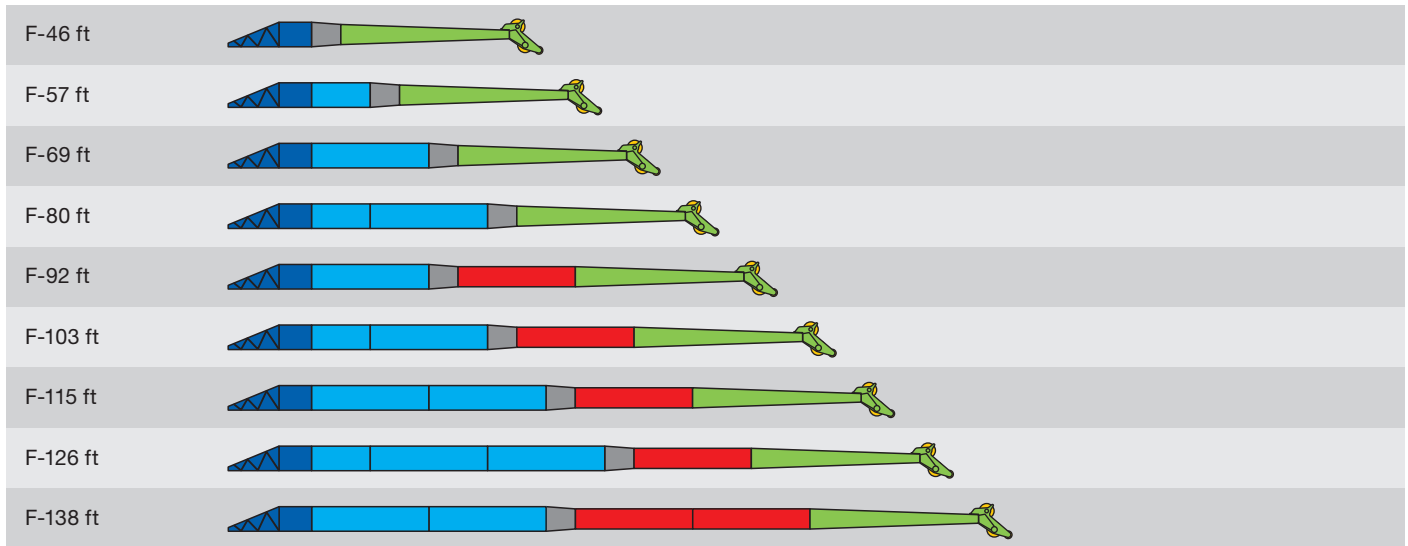

US2749

## Weights Poids



Axle Essieu	1	2	3	4	5	6	Total weight lbs Poids total lbs
lbs	26400	26400	26400	26400	26400	26400	158400



Load kips Forces de levage kips	No. of sheaves Poulies	No. of lines Brins	Weight lbs Poids lbs
403.5	12	17	7500
343.3	7	14	3300
275.6	5	11	3530
176.4	3	7	3200
79.8	1	3	2200
27.1	-	1	1100

## Working speeds Vitesses



	(mph) min. МИН.	(mph) max. МАКС.	%
445/95 R 25 (16.00 R 25) 525/80 R 25 (20.5 R 25)	1.3	50	50.9 %







12 / R2



Drive Mécanismes	infinitely variable en continu	Rope diameter / length Diamètre / Longueur du câble	Max. single line pull Effort au brin maxi.
	0 – 427 ft/min single line ft/min au brin simple	0.9" / 984 ft	27420 lbs
	0 – 427 ft/min single line ft/min au brin simple	0.9" / 1525 ft	27420 lbs
	0 – 1.6 rpm		
	approx. 80 seconds to reach 82° boom angle env. 80 s jusqu'à 82°		
	approx. 800 seconds for boom extension from 48 ft – 256 ft env. 800 s pour passer de 48 ft – 256 ft		

# Lifting capacities Forces de levage

T

48 - 256 ft  
  
  
  
  
**85%**

**Preliminary  
Préliminaire**

ft	48 ft		64 ft	80 ft	96 ft	112 ft	128 ft	144 ft	160 ft	176 ft	192 ft	208 ft	224 ft	240 ft	253 ft	256 ft	ft
	*																
10	661.4	298.6															10
11	504.2	298.6	298.6														11
12	403.4	298.6	298.6	298.6													12
13	385.2	298.6	298.6	298.6													13
14	365.9	298.6	298.6	298.6													14
15	349.7	298.6	298.6	298.6	248.3	191.2											15
16	332.8	298.6	298.6	290.6	247.8	198.4											16
17	318	297.3	296.2	279.6	246.7	198											17
18	307.3	293.5	287.2	272.7	245.5	197.6											18
19	297.7	284.4	278.8	264.2	244.2	197.1	159.8										19
20	288.4	274.8	270.9	256.3	241.9	196.2	159.3										20
22	271.3	256.4	257.1	241.9	230.3	194.3	158.3	130.2									22
24	255	239.4	241.2	229.6	217.8	192.3	157.4	129.7									24
26	235.7	223	225	218.6	206.8	190.4	156.4	129.2	102.1								26
28	218.3	208.6	210.6	208	197	186.8	155.4	128.6	101.9								28
30	202.9	195.8	197.7	197.6	188.3	182.4	154.4	128	101.7	82.1							30
32	189.4	184.2	186.1	186.5	180.4	174.6	153.2	127.4	101.2	82							32
34	177.5	173.3	175.3	175.9	172.7	167.5	151.9	126.8	100.9	81.8	66.1						34
36	166.8	163.6	165.4	166.1	165.2	161.1	150.5	126.1	100.5	81.5	65.8						36
38	156	154.6	156.5	157.2	156.6	155.1	147.1	125.1	99.1	81.1	65.6	54.1					38
40	130.5	130.5	148	148.7	148.1	148.7	142.2	123.9	97.6	80.6	65.4	53.9					40
45			130	130.1	132.1	131.7	129.4	120.6	92.3	78.6	64.6	53.4	43.6				45
50			115.9	117.4	117.5	116.6	115.2	114.3	86.4	75.4	63.3	52.9	43.3	36.5	30.3		50
55			96.1	105.1	105.2	104.3	104.9	104.3	81.2	71.2	61.2	52.1	42.5	36.1	30.1	29.3	55
60				94.8	94.8	93.9	96.1	94.5	76.2	67.3	58.4	50.5	41.5	35.4	29.9	29.2	60
65				85.7	85.7	84.7	86.9	85.4	71.5	63.5	55.5	48.5	40.4	34.6	29.4	28.8	65
70				74.2	77.9	78.8	79.1	77.6	67.3	59.8	52.8	46.5	39.1	33.7	28.8	28.4	70
75					71.1	73.3	72.3	70.8	63.3	56.2	50.1	44.5	37.8	32.7	28	27.7	75
80					65.3	67.4	66.4	64.8	59.6	53.2	47.5	42.6	36.5	31.6	27.1	26.8	80
85					60.7	62.2	61.2	59.6	56.2	50.1	45.1	40.6	35.3	30.5	26.3	26	85
90						57.6	56.6	55	52.8	47.3	42.9	38.7	34	29.5	25.4	25.2	90
95						53.6	52.5	50.9	49.3	44.9	40.7	36.9	32.8	28.6	24.6	24.4	95
100						49.3	48.8	47.2	45.7	42.5	38.6	35.2	31.6	27.6	23.8	23.6	100
105						25.6	45.5	43.9	43.5	40.1	36.8	33.6	30.5	26.7	23	22.9	105
110							42.5	40.9	41.9	38.1	34.9	32.1	29.3	25.8	22.3	22.2	110
115							39.5	38.1	39.7	36	33.1	30.6	28.2	25	21.5	21.5	115
120							27.2	36.9	37.2	33.6	31.5	29.2	27.1	24.2	20.9	20.8	120
125								35.9	34.9	32.1	30.1	27.9	26	23.4	20.2	20.2	125
130								34.3	32.7	30.7	28.6	26.5	25	22.6	19.6	19.6	130
135								24.2	30.7	28.7	27.1	25.4	23.9	22	19	19	135
140									28.9	26.9	25.4	24.2	22.9	21.3	18.4	18.4	140
145									27	25.9	24.3	23.1	22	20.6	17.8	17.7	145
150									21.8	25.2	23.3	22.1	21.1	20	17.3	17.1	150
155										24.7	22.4	21.1	20.2	19.3	16.7	16.5	155
160										23.4	21.1	19.8	19.3	18.6	16.2	15.8	160
165										18.6	19.8	19.1	18.5	17.9	15.6	15.2	165
170											19.1	18.4	17.8	17.2	15.1	14.6	170
175											18.7	17.8	16.9	16.5	14.6	14	175
180											15.3	17.1	16	15.9	14.2	13.3	180
185												16.2	15.5	15.3	13.7	12.7	185
190												15.3	15.1	14.6	13.2	12.2	190
195												13.2	14.6	13.9	12.8	11.6	195
200												5.4	14.2	13	12.3	11.1	200
205													13.5	12.2	11.9	10.6	205
210													10.3	11.4	11.4	10.1	210
215													4.7	10.7	10.9	9.6	215
220														9.9	10.2	9.2	220
225														7.2	9.5	8.7	225
230															8.8	8.3	230
235															7.6	7.9	235
240															4.8	5.9	240

\* over rear - en arrière





t\_240\_001\_50001\_00\_000 / 001\_50301\_00\_000



# Lifting capacities Forces de levage

T

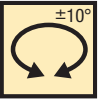
48 - 256 ft

85%





Preliminary  
Préliminaire

ft	48 ft	64 ft	80 ft	96 ft	112 ft	128 ft	144 ft	160 ft	176 ft	192 ft	208 ft	224 ft	240 ft	253 ft	256 ft	ft	
10	298.6															10	
11	298.6	298.6														11	
12	298.6	298.6	298.6													12	
13	298.6	298.6	298.6													13	
14	298.6	298.6	298.6													14	
15	298.6	298.6	298.6	248.3	191.2											15	
16	298.6	298.6	290.6	247.8	198.4											16	
17	298.6	296.2	279.6	246.7	198											17	
18	298.6	287.2	272.7	245.5	197.6											18	
19	294.9	278.8	264.2	244.2	197.1	159.8										19	
20	288.4	270.9	256.3	241.9	196.2	159.3										20	
22	271.3	257.2	241.9	230.3	194.3	158.3	130.2									22	
24	255	242.8	229.6	217.8	192.3	157.4	129.7									24	
26	235.7	230.1	218.6	206.8	190.4	156.4	129.2	102.1								26	
28	218.3	218.3	208	197	186.8	155.4	128.6	101.9								28	
30	202.9	205.1	198	188.3	182.4	154.4	128	101.7	82.1							30	
32	189.4	191.5	188.9	180.4	174.6	153.2	127.4	101.2	82							32	
34	177.5	179.5	179.5	172.7	167.5	151.9	126.8	100.9	81.8	66.1						34	
36	166.8	168.7	169.5	165.2	161.1	150.5	126.1	100.5	81.5	65.8						36	
38	156	159.1	159.8	158.1	155.1	147.1	125.1	99.1	81.1	65.6	54.1					38	
40	130.5	150.5	151.1	150.6	149.2	142.2	123.9	97.6	80.6	65.4	53.9					40	
45		131.9	132.6	132.2	133.9	130.1	120.6	92.3	78.6	64.6	53.4	43.6				45	
50		118.4	117.7	119.9	119	117.7	115.2	86.4	75.4	63.3	52.9	43.3	36.5	30.3		50	
55		96.1	107.6	107.6	106.8	105.5	106.9	81.2	71.2	61.2	52.1	42.5	36.1	30.1	29.3	55	
60			97.3	97.4	96.5	98	97.1	76.2	67.3	58.4	50.5	41.5	35.4	29.9	29.2	60	
65			88.4	88.4	87.4	89.6	88.1	71.5	63.5	55.5	48.5	40.4	34.6	29.4	28.8	65	
70			74.2	80.6	79.6	81.8	80.3	67.3	59.8	52.8	46.5	39.1	33.7	28.8	28.4	70	
75				73.8	74	74.9	73.5	63.3	56.2	50.1	44.5	37.8	32.7	28	27.7	75	
80				68	69.8	69	67.5	59.6	53.2	47.5	42.6	36.5	31.6	27.1	26.8	80	
85				60.7	64.8	63.8	62.2	56.2	50.1	45.1	40.6	35.3	30.5	26.3	26	85	
90					60.2	59.1	57.6	52.8	47.3	42.9	38.7	34	29.5	25.4	25.2	90	
95					56.1	55	53.4	49.5	44.9	40.7	36.9	32.8	28.6	24.6	24.4	95	
100					49.3	51.3	49.7	46.9	42.5	38.6	35.2	31.6	27.6	23.8	23.6	100	
105					25.6	47.9	46.3	44.3	40.1	36.8	33.6	30.5	26.7	23	22.9	105	
110						44.9	43.2	41.9	38.1	34.9	32.1	29.3	25.8	22.3	22.2	110	
115						39.6	40.4	40.6	36.3	33.1	30.6	28.2	25	21.5	21.5	115	
120							27.2	37.9	39.2	34.4	31.5	29.2	27.1	24.2	20.9	20.8	120
125								35.9	37	32.7	30.1	27.9	26	23.4	20.2	20.2	125
130								34.7	34.9	31.1	28.6	26.5	25	22.6	19.6	19.6	130
135								24.2	32.9	29.3	27.2	25.4	23.9	22	19	19	135
140									31.1	27.9	26	24.2	22.9	21.3	18.4	18.4	140
145									27.5	26.8	24.8	23.1	22	20.6	17.8	17.7	145
150									21.8	25.6	23.6	22.1	21.1	20	17.3	17.1	150
155										24.7	22.6	21.1	20.2	19.3	16.7	16.5	155
160										24	21.6	20.2	19.3	18.6	16.2	15.8	160
165										18.6	20.8	19.3	18.5	17.9	15.6	15.2	165
170											20	18.5	17.8	17.2	15.1	14.6	170
175											18.7	17.8	17	16.5	14.6	14	175
180											15.3	17.2	16.3	15.9	14.2	13.3	180
185												16.6	15.6	15.3	13.7	12.7	185
190												15.7	15.1	14.6	13.2	12.2	190
195												13.2	14.6	14	12.8	11.6	195
200												5.4	14.2	13.5	12.3	11.1	200
205													13.7	13	11.9	10.6	205
210													10.3	12.5	11.4	10.1	210
215													4.7	11.8	11	9.6	215
220														10.3	10.6	9.2	220
225														7.2	10.2	8.7	225
230															9.6	8.3	230
235															7.6	7.9	235
240															4.8	5.9	240

t\_240\_001\_50201\_00\_000

# Lifting capacities Forces de levage

T

48 - 256 ft  
  
  
  
  
**85%**

**Preliminary  
Préliminaire**





ft	48 ft	64 ft	80 ft	96 ft	112 ft	128 ft	144 ft	160 ft	176 ft	192 ft	208 ft	224 ft	240 ft	253 ft	256 ft	ft
10	298.6															10
11	298.6	298.6														11
12	298.6	298.6	298.6													12
13	298.6	298.6	298.6													13
14	298.6	298.6	298.6													14
15	298.6	298.6	298.6	248.3	191.2											15
16	298.6	298.6	290.6	247.8	198.4											16
17	294.7	296.2	279.6	246.7	198											17
18	283.8	284.5	272.7	245.5	197.6											18
19	272.1	272.9	264.2	244.2	197.1	159.8										19
20	260.7	262.7	256.3	241.9	196.2	159.3										20
22	239.6	241.8	241.8	230.3	194.3	158.3	130.2									22
24	220.5	222.6	223.1	217.7	192.3	157.4	129.7									24
26	202.5	204.9	205.8	204.4	190.4	156.4	129.2	102.1								26
28	187	189.3	190.1	189.2	186	155.4	128.6	101.9								28
30	173.4	176.4	176.2	178.5	173.9	154.4	128	101.7	82.1							30
32	160.9	164.8	166.5	166.7	162.4	152.7	127.4	101.2	82							32
34	149.3	153.3	155.1	155.4	152.1	145.3	126.8	100.9	81.8	66.1						34
36	139.1	142.9	144.9	144.8	143	136.7	126.1	100.5	81.5	65.8						36
38	130	133.8	135.7	135.9	134.6	131.9	124.2	99.1	81.1	65.6	54.1					38
40	121.9	125.7	127.4	127.6	126.6	126	120.3	97.6	80.6	65.4	53.9					40
45		108.4	110.2	110.2	111.7	110.3	104.3	92.3	78.6	64.6	53.4	43.6				45
50		93.2	95.2	96.8	98.1	96.2	90.7	85.3	75.4	63.3	52.9	43.3	36.5	30.3		50
55		79.9	81.9	85.1	84.8	83.7	79.6	75.8	70.9	61.2	52.1	42.5	36.1	30.1	29.3	55
60			73	74.1	73.8	72.7	70.9	67.8	63.7	58.4	50.5	41.5	35.4	29.9	29.2	60
65			64.4	65.2	64.9	63.7	62.5	61.4	58	54.3	48.5	40.4	34.6	29.4	28.8	65
70			57.2	57.9	57.6	56.5	56.5	56.5	52.6	48.8	46	39.1	33.7	28.8	28.4	70
75				51.8	51.5	50.3	52	50.6	47.3	45.9	42.7	37.8	32.7	28	27.7	75
80				46.7	46.3	46.8	47.2	45.4	42.7	41.8	38.6	36.5	31.6	27.1	26.8	80
85				42.4	41.9	43.9	42.7	40.9	39.9	37.9	36	34.3	30.5	26.3	26	85
90					38.6	40	38.8	37.5	37.7	34.5	34.1	31.8	29.5	25.4	25.2	90
95					36.9	36.6	35.4	34.3	34.7	32.7	31.6	29.1	28.5	24.6	24.4	95
100					34.2	33.7	32.4	32.8	31.7	30.9	28.9	28	27	23.8	23.6	100
105					25.6	31	30.1	30.7	29.1	29.4	27.1	26.5	25.1	23	22.9	105
110						28.6	28.3	28.3	27.2	27	25.9	24.7	23	22	22	110
115						26.5	27.2	26.2	26	24.8	24.4	22.8	21.1	20.6	20.3	115
120						24.7	25.4	24.2	24.4	22.9	22.9	21.1	19.4	19	18.7	120
125							23.6	22.3	22.6	22	21.2	19.5	17.8	17.4	17.1	125
130							22	21.5	20.8	20.6	19.4	18	16.3	16	15.7	130
135							20.5	20.5	19.2	19.1	17.8	16.6	14.9	14.7	14.4	135
140								19	18	17.6	16.4	15.3	13.6	13.4	13.1	140
145								17.7	16.7	16.3	15	14	12.4	12.3	12	145
150								16.6	15.5	15	13.8	12.8	11.3	11.2	10.9	150
155									14.4	13.9	12.6	11.6	10.1	10.2	9.9	155
160									13.4	12.8	11.6	10.5	9.1	9.2	8.9	160
165									12.4	11.8	10.6	9.5	8.1	8.3	8.1	165
170										10.9	9.6	8.6	7.1	7.4	7.2	170
175										10	8.8	7.7	6.2	6.5	6.3	175
180										9.2	7.9	6.9	5.4	5.7	5.4	180
185											7.2	6.1	4.7	4.9	4.7	185
190											6.5	5.4	3.9	4.2	4	190
195											5.8	4.7		3.5		195
200											5.2	4.1				200
205												3.5				205
210																210

t\_240\_001\_00303\_00\_000

# Lifting capacities Forces de levage

T

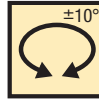
48 - 256 ft

85%

Preliminary  
Préliminaire

ft	48 ft	64 ft	80 ft	96 ft	112 ft	128 ft	144 ft	160 ft	176 ft	192 ft	208 ft	224 ft	240 ft	253 ft	256 ft	ft
10	298.6															10
11	298.6	298.6														11
12	298.6	298.6	298.6													12
13	298.6	298.6	298.6													13
14	298.6	298.6	298.6													14
15	298.6	298.6	298.6	248.3	191.2											15
16	298.6	298.6	290.6	247.8	198.4											16
17	298.6	296.2	279.6	246.7	198											17
18	298.6	287.2	272.7	245.5	197.6											18
19	285.3	278.8	264.2	244.2	197.1	159.8										19
20	271.2	268.7	256.3	241.9	196.2	159.3										20
22	246.1	248.5	241.9	230.3	194.3	158.3	130.2									22
24	225.1	227.3	227.2	217.8	192.3	157.4	129.7									24
26	206.9	209.2	210	206.6	190.4	156.4	129.2	102.1								26
28	191.4	193.6	194.3	193.5	186.8	155.4	128.6	101.9								28
30	177.8	179.9	180.5	180.7	179.5	154.4	128	101.7	82.1							30
32	165.8	168.6	168.4	170.3	168.3	153.2	127.4	101.2	82							32
34	154.9	158.5	159.6	160.2	158.2	148.7	126.8	100.9	81.8	66.1						34
36	144.9	148.6	150.3	150.3	148.8	140	126.1	100.5	81.5	65.8						36
38	136	139.6	141.4	141.5	138.9	132.1	124.8	99.1	81.1	65.6	54.1					38
40	127.8	131.5	133.2	133.3	129.9	127.1	121.1	97.6	80.6	65.4	53.9					40
45		110.4	112.8	112.8	113.1	110.5	104.5	92.3	78.6	64.6	53.4	43.6				45
50		93.2	95.2	96.8	98.2	96.4	91.4	85.8	75.4	63.3	52.9	43.3	36.5	30.3		50
55		79.9	81.9	85.1	84.8	83.8	80.5	76.5	71.2	61.2	52.1	42.5	36.1	30.1	29.3	55
60			73.2	74.4	74.1	73	71.2	69	64.9	58.4	50.5	41.5	35.4	29.9	29.2	60
65			65	65.8	65.4	64.3	63.1	61.8	58.5	54.7	48.5	40.4	34.6	29.4	28.8	65
70			57.9	58.7	58.3	57.3	56.7	57	53.8	50.1	46.4	39.1	33.7	28.8	28.4	70
75				52.7	52.3	51.2	52.5	51.5	48.6	45.9	44	37.8	32.7	28	27.7	75
80				47.7	47.2	46.8	48.1	46.4	44	42.8	39.9	36.5	31.6	27.1	26.8	80
85				43.4	42.9	44.5	43.6	41.9	40	39.2	36.3	35.1	30.5	26.3	26	85
90					39.1	41	39.8	38.4	37.7	35.8	34.5	33	29.5	25.4	25.2	90
95					37	37.6	36.4	35.2	35.8	32.7	32.9	30.2	28.6	24.6	24.4	95
100					35.2	34.6	33.4	32.9	32.7	31.1	30.2	28	27.6	23.8	23.6	100
105					25.6	30.8	31.4	30.1	29.6	27.8	27.8	26.9	26.1	23	22.9	105
110						29.6	28.7	29.3	27.8	28	26.1	25.8	24.2	22.3	22.1	110
115						27.5	27.2	27.2	26.1	25.8	25	24	22.3	21.5	21.2	115
120						25.7	26.2	25.2	25	23.8	23.7	22.2	20.5	20.1	19.8	120
125							24.6	23.4	23.6	22	22.2	20.6	18.9	18.6	18.2	125
130							23	21.7	21.8	21.1	20.4	19.1	17.4	17.1	16.8	130
135							21.5	20.7	20.2	20	18.8	17.7	16	15.8	15.4	135
140								19.9	18.8	18.6	17.4	16.3	14.7	14.5	14.2	140
145								18.7	17.4	17.2	16	15	13.5	13.3	13	145
150								17.5	16.4	15.9	14.7	13.7	12.2	12.2	11.9	150
155									15.3	14.8	13.6	12.5	11.1	11.2	10.9	155
160									14.2	13.7	12.5	11.5	10	10.2	9.9	160
165									13.3	12.7	11.5	10.4	9	9.2	9	165
170										11.7	10.5	9.5	8	8.3	8.1	170
175										10.9	9.6	8.6	7.1	7.4	7.2	175
180										10.1	8.8	7.8	6.3	6.5	6.3	180
185											8	7	5.5	5.8	5.5	185
190											7.3	6.2	4.8	5	4.8	190
195											6.6	5.6	4.1	4.3	4.1	195
200											5.4	4.9	3.4	3.6	3.4	200
205												4.3				205
210												3.7				210
215																215

t\_240\_001\_00203\_00\_000

# Lifting heights Hauteurs de levage

T

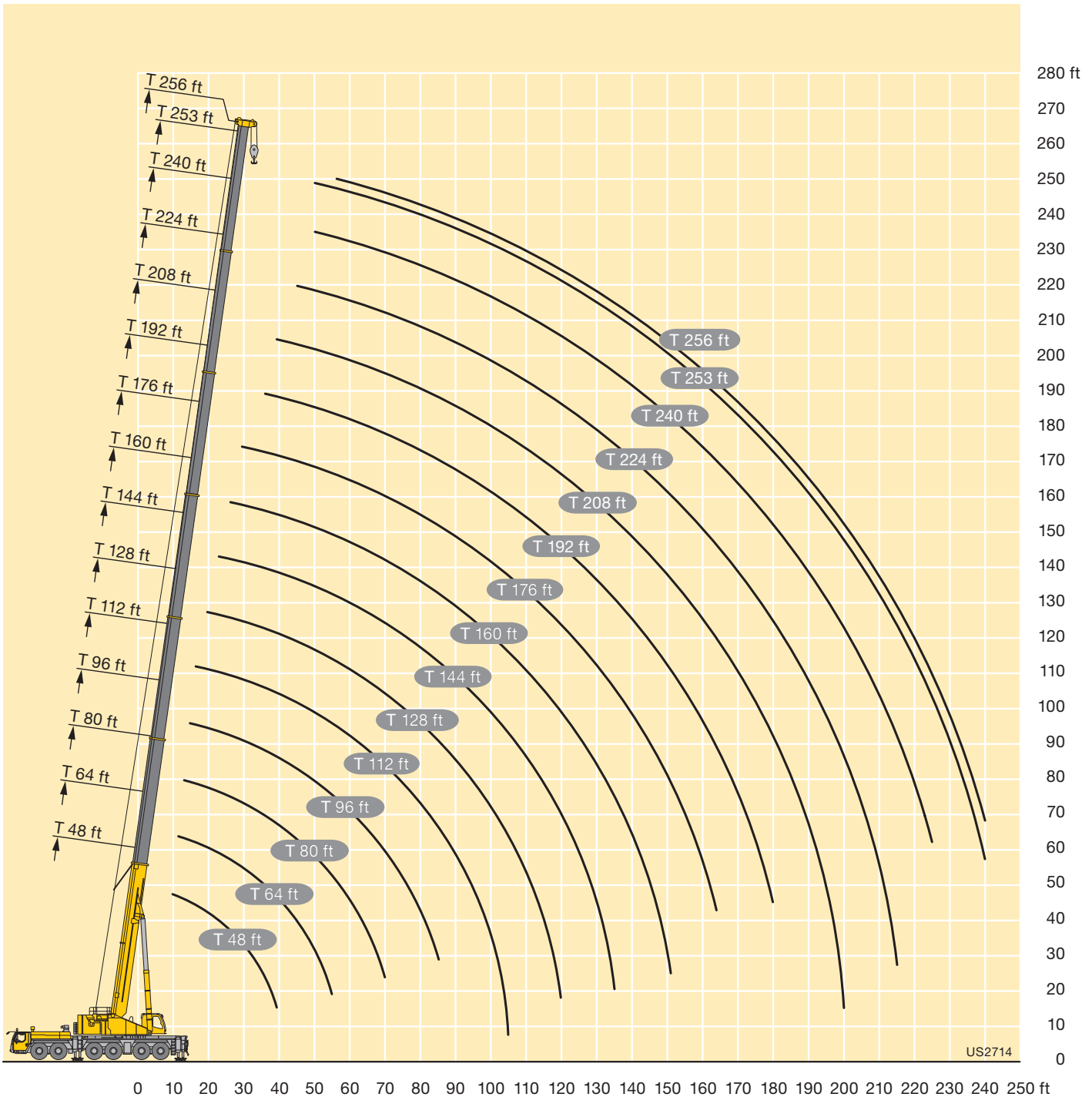

# Lifting capacities Forces de levage

TK



**Preliminary  
Préliminaire**

ft	48 ft			64 ft			80 ft			96 ft			112 ft			128 ft			144 ft			160 ft			ft
	18 ft			18 ft			18 ft			18 ft			18 ft			18 ft			18 ft						
	0°	20°	40°	0°	20°	40°	0°	20°	40°	0°	20°	40°	0°	20°	40°	0°	20°	40°	0°	20°	40°	0°	20°	40°	
12	128.3	101.2																						12	
13	125.9	99.2	84.3	130.9	103																			13	
14	122.7	97.2	82.9	130.3	101.1		130.4																	14	
15	119.5	95.3	81.7	127.6	99.4	83.9	129.2	100.7																15	
16	116.3	93.5	80.5	124.9	97.8	82.8	127.4	99.6		126.8														16	
17	113.7	91.8	79.3	122.4	96.2	81.8	125.2	98.2		125.1														17	
18	111.2	90.1	78.2	120	94.7	80.8	123.1	96.8	81.8	123.4	97.5		121.2											18	
19	108.6	88.4	77.1	117.6	93.3	79.9	121	95.5	81	121.7	96.4		119.9											19	
20	106	87	76.1	115.2	91.9	78.9	119	94.2	80.2	120	95.3		118.6											20	
22	101.2	84	74	110.7	89.2	77.1	115.1	91.7	78.5	116.6	93	79.4	115.9	93.5		105.6								22	
24	96.9	81.1	72.2	106.7	86.4	75.3	111.2	89.2	77	113.1	90.8	77.9	113.1	91.5	78.3	105.6	91.1							24	
26	92.9	78.6	70.4	102.6	84.1	73.6	107.5	87	75.4	109.9	88.7	76.5	110.2	89.5	77	105.3	89.6		95.2					26	
28	89.2	76.1	68.8	98.8	81.8	72.2	104.2	84.8	74.1	106.9	86.7	75.2	107.5	87.6	75.8	104.7	88.2	76.8	94.7	83.6				28	
30	86	73.8	67.3	95.4	79.5	70.8	101.1	82.8	72.7	103.9	84.8	73.9	104.8	85.8	74.6	103.9	86.9	75.8	94.2	82.7		79.4		30	
32	82.8	71.9	65.9	92.3	77.5	69.4	98	81	71.4	100.9	83	72.8	102.4	84.2	73.5	102.4	85.6	74.8	93.4	81.7	73	79.4		32	
34	79.9	70.1	64.7	89.2	75.6	68.2	95.1	79.2	70.2	98.5	81.2	71.6	100.1	82.6	72.4	100.8	84.3	73.9	92.4	80.7	72.2	79.3	73.9	34	
36	77.4	68.3	63.6	86.5	73.8	67	92.4	77.5	69.1	96.1	79.6	70.5	97.8	81.1	71.4	99.1	83.1	73	91.5	79.8	71.4	79	73.3	67.7	36
38	74.9	66.7	62.6	84.1	72.1	65.9	89.9	75.9	68	93.7	78.2	69.5	95.6	79.7	70.5	97.4	81.8	72.2	90.4	78.8	70.7	78.6	72.7	67.2	38
40	72.6	65.2	61.7	81.7	70.7	64.9	87.6	74.3	67	91.4	76.8	68.5	93.6	78.2	69.5	95.7	80.6	71.3	89.3	77.9	69.9	78.2	72	66.6	40
45	67.9	62.2	60.1	76.3	67.2	62.7	82.3	70.8	64.8	86.3	73.3	66.3	88.9	75.2	67.4	91.6	77.6	69.4	86.3	75.4	68.2	76.5	70.2	65.2	45
50	64.1	59.9	59.4	71.7	64.3	60.9	77.7	67.9	62.9	81.8	70.4	64.3	84.4	72.3	65.5	88	75	67.5	83.1	73.2	66.6	73.6	67.9	63.7	50
55	60.5	58.2	9.1	68	61.9	59.7	73.7	65.2	61.2	78	67.8	62.6	80.7	69.7	63.8	84.3	72.5	66	78.7	71	65.1	69.8	65.1	61.7	55
60				64.7	59.9	32.6	70.2	63	59.9	74.4	65.6	61.2	77.2	67.3	62.2	81.2	70.2	64.4	73.8	69	63.8	66.1	62.3	59.3	60
65				62.2	58.8	16	67.2	61.1	58.9	71.2	63.4	59.9	74.2	65.3	60.9	78.2	68.3	63.1	69.1	66.9	62.6	62.5	59.9	57.1	65
70				59.3	57.5	9.5	64.5	59.6	47.6	68.4	61.7	59	71.4	63.5	59.8	74.8	66.5	61.9	64.9	64.3	61	59	57.5	55.1	70
75				41.9			62.3	58.4	22.2	65.9	60.1	58.1	68.9	61.7	58.8	68.5	64.9	60.9	60.9	60.6	58.8	55.6	55.1	53.1	75
80							60.5	57.8	13.8	63.9	58.9	57.8	64.2	60.4	58	62.6	63	60.1	57.1	56.9	56.4	52.7	52.5	51.1	80
85							58.2	55.9	9.2	60.2	57.8	29	59	59	57.4	57.3	57.9	58	53.7	53.6	53.6	49.9	49.8	49	85
90							40.8	13.5		55.6	55.9	18.1	54.4	54.8	55	52.7	53.3	53.5	51.4	50.4	50.5	47.2	47.2	46.9	90
95										51.5	51.8	12.5	50.2	50.6	37.1	48.6	49.1	49.3	49.3	47.1	47.4	44.9	44.8	44.8	95
100										47.9	44.9	9	46.6	46.9	22.6	44.9	45.3	45.5	46.2	45.1	44.3	42.6	42.6	42.6	100
105										35.8	15.6	5.7	43.3	43.5	15.8	43.1	41.9	40.7	42.9	43.1	42.9	40.3	40.4	40.5	105
110													40.3	40.5	11.7	41.4	40.2	27.7	39.9	40.2	40.4	38.2	38.2	38.3	110
115													37.6	37.7	8.9	38.9	39	19.2	37.1	37.4	37.6	35.5	35.9	36.1	115
120													31	17	6.3	36.4	36.6	14.4	34.6	34.9	32.4	33	33.3	33.5	120
125																34.1	34.3	11.2	32.3	32.5	22.8	31.3	31.4	31.5	125
130																32	32.1	8.8	30.2	30.4	17.2	29.5	29.8	29.9	130
135																25	18.2	6.6	28.2	28.3	13.5	27.5	27.7	26.7	135
140																			26.3	26.4	10.8	25.6	25.8	20.1	140
145																			24.6	24.7	8.7	23.8	24	15.8	145
150																			20.7	19	6.9	22.2	22.4	12.7	150
155																						20.7	20.9	10.5	155
160																						19.4	19.4	8.6	160
165																						16.4	16.4	7	165
170																						10.5	9.4		170

† 240\_002\_50001\_00\_000 / 52001\_00\_000 / 54001\_00\_000

# Lifting capacities Forces de levage

TK

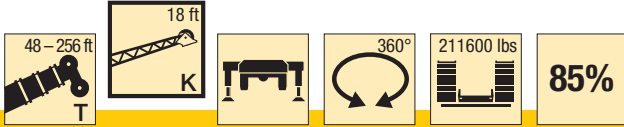

**Preliminary  
Préliminaire**

ft	176 ft			192 ft			208 ft			224 ft			240 ft			253 ft			256 ft			ft
	18 ft			18 ft			18 ft			18 ft			18 ft			18 ft			18 ft			
	0°	20°	40°	0°	20°	40°	0°	20°	40°	0°	20°	40°	0°	20°	40°	0°	20°	40°	0°	20°	40°	
34	64.7																					34
36	64.5																					36
38	64.2	64.7		51.5																		38
40	64	64.5		51.3																		40
45	63.2	63.7	61	50.8	51.2	51.4	41.6															45
50	62.2	62.8	60	50.3	50.7	51.2	41.3	41.5	42.2	34			25.4									50
55	60.7	60.6	58.7	49.7	50	50.5	40.9	41.2	41.3	33.8	33.8	34.1	25.3	25.4		21			20.4			55
60	57.9	57.8	56.7	48.7	48.8	49	40.3	40.1	40.2	33.2	33.2	33.5	25.1	25.2	25.1	21	21		20.4	20.4		60
65	55	54.9	54.4	46.9	47	47.2	39.1	38.9	39	32.5	32.4	32.6	24.9	24.9	25	20.9	20.9	20.9	20.3	20.4	20.3	65
70	52.2	52.2	52.1	44.9	45	45.3	37.9	37.7	37.7	31.6	31.4	31.5	24.6	24.5	24.6	20.7	20.7	20.8	20.2	20.3	20.3	70
75	49.6	49.5	49.7	43	43.1	43.3	36.6	36.4	36.3	30.6	30.3	30.4	24.1	24	24.1	20.4	20.3	20.4	20	20	20.1	75
80	46.9	47	47.1	41.1	41.1	41.4	35.3	35	34.9	29.5	29.3	29.3	23.5	23.4	23.5	19.9	19.9	19.9	19.6	19.6	19.6	80
85	44.4	44.4	44.6	39.2	39.2	39.5	34	33.7	33.6	28.5	28.3	28.3	22.8	22.8	22.8	19.4	19.3	19.4	19.1	19.1	19.1	85
90	42.1	42.1	42.3	37.3	37.4	37.6	32.7	32.4	32.3	27.5	27.3	27.3	22.2	22.1	22.2	18.8	18.7	18.8	18.6	18.5	18.5	90
95	39.8	40	40.1	35.5	35.6	35.8	31.4	31.2	31.1	26.6	26.3	26.3	21.5	21.4	21.5	18.2	18.1	18.2	18	17.9	18	95
100	37.7	37.8	38	33.8	33.9	34.1	30.1	30	29.9	25.6	25.4	25.4	20.9	20.7	20.8	17.6	17.5	17.6	17.4	17.4	17.4	100
105	35.9	35.9	36.1	32.1	32.2	32.5	28.9	28.8	28.8	24.7	24.5	24.5	20.2	20.1	20.1	17	16.9	17	16.9	16.8	16.8	105
110	34	34.2	34.3	30.6	30.6	30.9	27.6	27.6	27.6	23.7	23.6	23.6	19.5	19.4	19.5	16.5	16.4	16.4	16.3	16.2	16.3	110
115	32.2	32.4	32.5	29.1	29.2	29.4	26.3	26.4	26.5	22.9	22.7	22.7	18.9	18.8	18.8	15.9	15.9	15.9	15.8	15.7	15.7	115
120	30.6	30.7	30.8	27.7	27.8	28	25.1	25.2	25.3	22.1	21.9	21.9	18.2	18.1	18.2	15.4	15.3	15.4	15.3	15.2	15.2	120
125	29.1	29.2	29.3	26.3	26.5	26.6	24	24	24.2	21.3	21.2	21.2	17.6	17.5	17.6	14.8	14.8	14.8	14.7	14.7	14.7	125
130	27.7	27.7	27.9	25	25.2	25.3	22.9	23	23.1	20.5	20.4	20.4	17.1	17	17	14.3	14.3	14.3	14.3	14.2	14.2	130
135	25.8	26.1	26.3	23.8	23.9	24	21.8	22	22.1	19.7	19.6	19.7	16.5	16.4	16.5	13.8	13.8	13.8	13.8	13.7	13.8	135
140	23.9	24.2	24.4	22.7	22.8	22.9	20.8	20.9	21	19	18.9	19	15.9	15.9	15.9	13.4	13.4	13.4	13.3	13.3	13.3	140
145	22.9	22.9	23	21.5	21.7	21.8	19.8	19.9	20	18.2	18.2	18.3	15.4	15.4	15.4	12.9	12.9	12.9	12.9	12.8	12.9	145
150	21.9	21.9	22	20.5	20.6	20.7	18.9	19	19.1	17.5	17.5	17.6	15	14.9	14.9	12.5	12.5	12.5	12.4	12.4	12.5	150
155	20.6	20.8	18.2	19.2	19.5	19.6	17.9	18.1	18.2	16.7	16.8	16.9	14.5	14.4	14.5	12.1	12.1	12.1	12	12	12	155
160	19.2	19.3	14.7	17.8	18.1	18.1	17.1	17.2	17.3	16	16.1	16.2	14	14	14	11.7	11.7	11.7	11.7	11.6	11.7	160
165	17.8	18	12.2	17	17.1	17.1	16.2	16.3	16.4	15.3	15.4	15.4	13.6	13.5	13.6	11.3	11.3	11.3	11.3	11.3	11.3	165
170	16.6	16.7	10.2	16.3	16.3	16.4	15.4	15.6	15.6	14.6	14.6	14.7	13.1	13.1	13.1	10.9	10.9	11	10.9	10.9	10.9	170
175	15.5	15.6	8.6	15.7	15.7	13.9	14.5	14.7	14.7	13.8	13.9	14	12.7	12.7	12.7	10.6	10.6	10.6	10.6	10.6	10.6	175
180	13.1	13.2	7.1	14.8	14.9	11.8	13.5	13.5	13.6	13.2	13.3	13.3	12.3	12.3	12.3	10.2	10.2	10.2	10.2	10.2	10.2	180
185		9.3	9.1	13.8	13.9	10	12.9	12.9	13	12.6	12.7	12.7	11.9	11.9	11.9	9.8	9.8	9.9	9.7	9.8	9.8	185
190				12.8	12.9	8.6	12.4	12.5	12.5	11.4	11.4	11.5	11.5	11.5	11.6	9.5	9.5	9.5	9.2	9.3	9.3	190
195				10.7	10.7	7.2	11.9	12	11.4	10.9	11	11	11	11	11.1	9.1	9.1	9.2	8.8	8.8	8.9	195
200				7.7	7.7	5.1	11.4	11.4	9.9	9.4	9.7	9.8	10.5	10.6	10.6	8.8	8.8	8.9	8.3	8.4	8.4	200
205							9.8	9.9	8.5	7.5	7.9	7.8	10	10.1	10.1	8.5	8.5	8.5	7.9	7.9	8	205
210							8.8	8.8	7.3	5.7	6	6	9.5	9.6	9.6	8.1	8.2	8.2	7.5	7.5	7.5	210
215							5.7	5.8	4.2	4	4.3	4.2	8.8	8.9	8.9	7.8	7.9	7.9	7.1	7.1	7.1	215
220										2.4	2.6	2.3	8.1	8.2	8.2	7.5	7.6	7.6	6.7	6.7	6.7	220
225													7.4	7.5	7.5	7.2	7.2	7.3	6.3	6.3	6.3	225
230													6.9	6.9	6.9	6.9	7	7	5.9	5.9	6	230
235													6.4	6.4	6.4	6.5	6.5	6.5	5.6	5.6	5.6	235
240													4.6	4.8	4.3	5.9	6	6	5.2	5.2	5.2	240
245																5.3	5.3	5.3	4.9	4.9	4.8	245
250																4.4	4.6	4.3	4.4	4.4	4.4	250
255																	2.1		2.8	3	2.6	255

t\_240\_002\_50001\_00\_000 / 52001\_00\_000 / 54001\_00\_000

# Lifting capacities Forces de levage

TK



Preliminary  
Préliminaire

ft	48 ft			144 ft			160 ft			176 ft			192 ft			ft
	41 ft			41 ft			41 ft			41 ft			41 ft			
	0°	20°	40°	0°	20°	40°	0°	20°	40°	0°	20°	40°	0°	20°	40°	
12	52.4															12
13	52.1															13
14	51.7															14
15	51.2															15
16	50.7															16
17	50.1															17
18	49.5															18
19	48.9	39.2														19
20	48.3	39														20
22	47.1	37.2														22
24	45.8	35.3		52.7												24
26	44.3	33.6		52.8												26
28	42.9	32.1	23.1	52.8			47.4									28
30	41.4	30.8	22.8	52.6			47.4									30
32	40.1	29.5	22.1	52.4			47.4			41.7						32
34	38.8	28.5	21.6	52			47.3			41.6						34
36	37.6	27.4	21.1	51.7			47.1			41.6			35.6			36
38	36.3	26.4	20.6	51.2	38.4		46.7			41.5			35.7			38
40	34.9	25.6	20.2	50.7	37.5		46.3			41.3			35.7			40
45	31.2	23.6	19.2	49.3	35.2	23.1	45.4	36.1		40.7			35.5			45
50	28	22.1	18.4	47.8	33.3	22.3	44.5	34.1	22.5	40.1	34.5		35.2			50
55	25.4	20.8	17.8	46.3	31.6	21.7	43.5	32.3	21.9	39.5	32.9	22	34.8	31.8		55
60	23.4	19.6	17.4	44.6	30	21.1	42.6	30.8	21.3	38.8	31.3	21.4	34.4	31	21.5	60
65	21.6	18.7	17.1	42.9	28.7	20.6	41.4	29.5	20.8	38.2	29.9	20.9	34	30.1	20.9	65
70	20.1	18	17.1	41.1	27.5	20.1	40.1	28.3	20.3	37.5	28.7	20.5	33.6	28.8	20.5	70
75	18.8	17.6	16.3	39.5	26.4	19.6	38.8	27.2	19.9	36.7	27.5	20	33.1	27.7	20.1	75
80	17.8	17.5		38	25.4	19.2	37.6	26.2	19.5	35.8	26.6	19.7	32.7	26.7	19.7	80
85				36.5	24.5	18.9	36.4	25.2	19.1	34.9	25.7	19.3	32	25.8	19.4	85
90				34.8	23.6	18.6	35.2	24.4	18.8	34	24.8	19	31.4	25	19.1	90
95				33	22.9	18.3	34.1	23.6	18.5	33.1	24	18.7	30.7	24.3	18.8	95
100				31.3	22.2	18	32.9	22.9	18.2	32.3	23.3	18.4	29.9	23.5	18.5	100
105				29.6	21.5	17.8	31.4	22.3	18	31.5	22.7	18.1	29	22.9	18.2	105
110				28.2	20.9	17.6	30	21.7	17.8	30.5	22.1	17.9	27.8	22.3	18	110
115				26.9	20.4	17.4	28.6	21	17.6	29.4	21.5	17.7	26.5	21.7	17.8	115
120				25.7	19.9	17.3	27.3	20.6	17.4	28.2	21	17.5	25.4	21.1	17.6	120
125				24.6	19.4	17.2	26.3	20.1	17.3	27	20.5	17.4	24.3	20.7	17.4	125
130				23.7	19	17.1	25.2	19.6	17.1	25.9	20.1	17.2	23.2	20.3	17.3	130
135				22.8	18.7	17.1	24.2	19.2	17.1	24.7	19.7	17.2	22.2	19.9	17.2	135
140				21.9	18.3	17.1	23.3	18.9	17	23.6	19.3	17.1	21.2	19.5	17.1	140
145				21.1	18	15.7	22.6	18.6	17	22.6	18.9	17	20.2	19.1	17.1	145
150				20.4	17.8	10.1	21.8	18.2	17	21.5	18.6	17	19.3	18.7	17	150
155				19.7	17.6	7.2	21	18	16.5	20.4	18.4	17	18.4	18.3	17	155
160				19.1	17.5	5.4	20.4	17.8	12.4	19	18.1	17	17.5	17.8	16.8	160
165				18.6	17.5		19.4	17.6	8.7	17.7	17.8	17	16.7	17.1	16.6	165
170				17.2	16		18.1	17.5	6.6	17	17.1	15.1	16	16.4	16.4	170
175				10.2	6.9		17	17.4	5.1	16.3	16.5	10.5	15	15.6	15.9	175
180							15.9	16.3		15.5	15.8	7.8	14	14.7	15	180
185							13.3	15.2		14.5	15	6.1	13.1	13.6	12.2	185
190							7.7	7.5		13.6	14	4.9	12.6	12.7	9.1	190
195										12.7	13		12.1	12.2	7.2	195
200										10.4	12.1		11.6	11.7	5.8	200
205										6.1	7.8		11	11.3		205
210													10.3	10.6		210
215													8.3	9.8		215
220													7.1	7.2		220
225																225

t\_240\_002\_50101\_00\_000 / 52101\_00\_000 / 54101\_00\_000

# Lifting capacities Forces de levage

TK

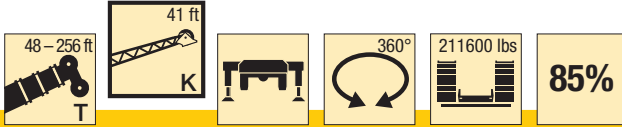

**Preliminary  
Préliminaire**

ft	208 ft			224 ft			240 ft			253 ft			256 ft			ft
	41 ft			41 ft			41 ft			41 ft			41 ft			
	0°	20°	40°	0°	20°	40°	0°	20°	40°	0°	20°	40°	0°	20°	40°	
45	30			23.3												45
50	30.1			23.5			19.4									50
55	29.9			23.6			19.4			16.4			15.9			55
60	29.7	28.3		23.8			19.4			16.4			15.9			60
65	29.5	27.8	20.9	23.9	23.9		19.3			16.4			16			65
70	29.3	27.4	22.6	23.8	23.7		19.2	19.2		16.3			15.9			70
75	28.9	26.9	22	23.6	23.3	22.5	19.1	18.8		16.1	16		15.8	15.7		75
80	28.5	26.4	21.5	23.2	22.8	22.1	18.9	18.4	17.8	15.9	15.8		15.6	15.5		80
85	28.1	25.6	21.1	22.6	22.3	21.7	18.7	17.9	17.4	15.7	15.5	15.1	15.4	15.2	15	85
90	27.4	24.8	20.8	22.1	21.7	21.2	18.2	17.5	16.9	15.5	15.1	14.7	15.2	15	14.6	90
95	26.7	24.1	20.5	21.5	21.1	20.7	17.9	17	16.5	15.1	14.8	14.4	14.9	14.6	14.2	95
100	25.8	23.4	20.2	20.8	20.4	20.3	17.4	16.6	16	14.7	14.4	14	14.5	14.3	13.9	100
105	24.9	22.8	19.9	20.2	19.8	19.7	17	16.1	15.6	14.3	14.1	13.7	14.1	13.9	13.6	105
110	24	22.2	19.4	19.5	19.1	19.1	16.5	15.7	15.2	13.9	13.7	13.4	13.8	13.6	13.3	110
115	23.2	21.7	18.8	18.9	18.5	18.5	16.1	15.3	14.9	13.5	13.3	13	13.4	13.2	12.9	115
120	22.4	21.1	18.2	18.2	17.9	17.9	15.6	14.9	14.5	13.1	12.9	12.7	12.9	12.8	12.6	120
125	21.5	20.7	17.6	17.6	17.3	17.3	15.1	14.6	14.2	12.6	12.5	12.4	12.5	12.4	12.3	125
130	20.7	20.1	17.3	17	16.8	16.7	14.6	14.2	13.9	12.2	12.1	12.1	12.1	12	12.1	130
135	19.9	19.6	17.2	16.4	16.2	16.2	14.1	13.8	13.6	11.8	11.7	11.8	11.7	11.6	11.7	135
140	19.1	19	17.1	15.9	15.7	15.7	13.7	13.4	13.2	11.4	11.3	11.4	11.3	11.2	11.4	140
145	18.3	18.3	17.1	15.4	15.2	15.2	13.2	13	12.9	11	10.9	11	10.9	10.9	11	145
150	17.5	17.7	17	14.9	14.7	14.7	12.8	12.7	12.6	10.6	10.6	10.7	10.6	10.5	10.6	150
155	16.7	17.1	16.8	14.4	14.3	14.3	12.4	12.3	12.3	10.3	10.2	10.3	10.2	10.2	10.3	155
160	16	16.4	16.3	13.9	13.8	13.8	12	11.9	12	9.9	9.9	10	9.9	9.8	9.9	160
165	15.3	15.6	15.7	13.5	13.3	13.4	11.6	11.6	11.6	9.6	9.5	9.6	9.5	9.5	9.6	165
170	14.6	14.9	15.2	13	12.9	13	11.2	11.2	11.3	9.2	9.2	9.3	9.2	9.2	9.3	170
175	13.9	14.2	14.5	12.5	12.5	12.6	10.9	10.8	10.9	8.9	8.9	9	8.9	8.9	9	175
180	13.2	13.6	13.9	12.1	12.1	12.2	10.5	10.5	10.6	8.6	8.6	8.7	8.6	8.6	8.7	180
185	12.6	13	13.2	11.6	11.7	11.8	10.2	10.2	10.3	8.3	8.3	8.4	8.3	8.3	8.4	185
190	12	12.3	12.6	11.1	11.3	11.5	9.8	9.9	9.9	8	8	8.1	8	8	8.1	190
195	11.2	11.7	11.9	10.7	10.9	11.1	9.5	9.5	9.6	7.8	7.8	7.9	7.7	7.8	7.9	195
200	10.3	11	10.7	10.2	10.4	10.7	9.2	9.2	9.3	7.5	7.5	7.6	7.4	7.5	7.6	200
205	9.8	10.1	8.3	9.7	10	10.2	8.9	8.9	9.1	7.3	7.3	7.4	7.1	7.3	7.4	205
210	9.5	9.5	6.7	9.2	9.5	9.7	8.6	8.7	8.8	7.1	7	7.1	6.8	7.1	7.1	210
215	9.1	9.2	5.5	8.7	9	9.2	8.3	8.4	8.5	6.8	6.8	6.9	6.5	6.8	6.8	215
220	8.7	8.8		7.9	8.4	7.6	7.9	8.1	8.2	6.6	6.6	6.7	6.2	6.4	6.5	220
225	8.4	8.5		7.6	7.7	6.3	7.6	7.8	7.9	6.4	6.4	6.5	5.9	6.1	6.2	225
230	7	8.2		7.4	7.4	5.3	7.2	7.5	7.6	6.2	6.2	6.3	5.5	5.7	5.9	230
235	5.6	6.6		7.1	7.2		6.8	7.1	7	6	6	6.1	5.1	5.4	5.5	235
240				6.9	6.9		6.3	6.6	6	5.8	5.8	5.9	4.8	5	5.1	240
245				6.1	6.8		5.8	6.1	5.1	5.5	5.6	5.7	4.4	4.7	4.7	245
250				3.5	4.8		5.1	5.5		5.2	5.4	5.5	4.1	4.3	4.4	250
255							4.6	4.9		4.6	5	5.1	3.8	4	4	255
260							3.2	4.3		4	4.4		3.5	3.7	3.7	260
265										3.4	3.8		3.2	3.4		265
270										2.8	3.2		2.7	3		270
275														2.4		275

t\_240\_002\_50101\_00\_000 / 52101\_00\_000 / 54101\_00\_000



# Lifting capacities Forces de levage

TK

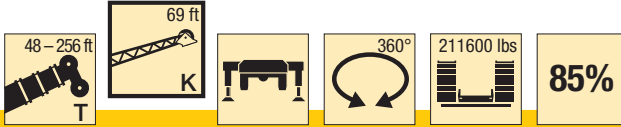

**Preliminary  
Préliminaire**

ft	48 ft			144 ft			160 ft			176 ft			192 ft			ft
	69 ft			69 ft			69 ft			69 ft			69 ft			
	0°	20°	40°	0°	20°	40°	0°	20°	40°	0°	20°	40°	0°	20°	40°	
12	20.8															12
13	20.8															13
14	20.9															14
15	21															15
16	21															16
17	21															17
18	21															18
19	21															19
20	21															20
22	21															22
24	20.9															24
26	20.7															26
28	20.5			20.8												28
30	20.3			20.9			19.9									30
32	20			21			19.9									32
34	19.7	17.8		21			19.9			18.7						34
36	19.4	17.5		21			19.9			18.7						36
38	19.1	17.2		21			19.9			18.8			17.4			38
40	18.7	16.9		21			19.9			18.8			17.4			40
45	17.9	16.1		21			19.9			18.8			17.5			45
50	17.1	15.4		20.8			19.9			18.8			17.5			50
55	16.3	14.7	13.2	20.5	17.5		19.8	17.2		18.8			17.5			55
60	15.5	14.1	12.8	20.3	17		19.6	16.8		18.7	16.3		17.5			60
65	14.8	13.6	12.4	19.9	16.7		19.3	16.4		18.5	16		17.3	15.2		65
70	14.2	13.1	12	19.5	16.2	13.4	19	16		18.2	15.6		17.1	15		70
75	13.6	12.6	11.8	19	15.8	13.2	18.6	15.6	13.1	17.9	15.3		16.8	14.7		75
80	13.1	12.3	11.6	18.6	15.4	13	18.2	15.3	12.9	17.6	15	12.7	16.6	14.4		80
85	12.6	12	11.4	18.1	15.1	12.8	17.8	15	12.7	17.2	14.7	12.5	16.3	14.2	12.2	85
90	12.1	11.7	11.4	17.7	14.7	12.6	17.4	14.6	12.5	16.9	14.4	12.3	16	13.9	12.1	90
95	11.6	11.5	11.4	17.2	14.4	12.4	17	14.3	12.3	16.5	14.1	12.2	15.7	13.7	11.9	95
100	11.1	11.4	11.4	16.7	14.1	12.2	16.6	14.1	12.2	16.2	13.9	12	15.4	13.4	11.8	100
105	10.6	11.3	4.5	16.3	13.8	12.1	16.2	13.8	12	15.9	13.6	11.9	15.1	13.2	11.7	105
110	9.8			15.9	13.5	11.9	15.8	13.5	11.9	15.5	13.4	11.7	14.9	13	11.5	110
115				15.5	13.3	11.8	15.5	13.3	11.8	15.2	13.1	11.6	14.6	12.8	11.4	115
120				15.1	13.1	11.7	15.1	13	11.6	14.9	12.9	11.5	14.4	12.6	11.3	120
125				14.7	12.8	11.6	14.8	12.8	11.5	14.6	12.7	11.4	14.1	12.4	11.2	125
130				14.4	12.6	11.5	14.4	12.6	11.4	14.3	12.5	11.4	13.9	12.3	11.1	130
135				14.1	12.4	11.5	14.1	12.4	11.4	14	12.3	11.3	13.6	12.1	11.1	135
140				13.7	12.2	11.4	13.8	12.3	11.3	13.8	12.2	11.2	13.4	11.9	11	140
145				13.4	12.1	11.4	13.6	12.1	11.3	13.5	12	11.2	13.2	11.8	11	145
150				13.1	11.9	11.4	13.3	11.9	11.2	13.3	11.9	11.1	13	11.7	10.9	150
155				12.9	11.8	11.4	13	11.8	11.2	13	11.7	11.1	12.8	11.5	10.9	155
160				12.6	11.7	11.4	12.8	11.7	11.2	12.8	11.6	11.1	12.6	11.4	10.8	160
165				12.3	11.6	11.4	12.5	11.6	11.2	12.5	11.5	11.1	12.4	11.3	10.8	165
170				12	11.5	11.4	12.3	11.5	11.2	12.3	11.4	11.1	12.2	11.2	10.8	170
175				11.8	11.5	11.4	12.1	11.4	11.2	12.1	11.3	11.1	12	11.1	10.8	175
180				11.5	11.4	8.6	11.8	11.3	11.2	12	11.2	11.1	11.8	11.1	10.8	180
185				11.2	11.3	6.2	11.6	11.3	11.2	11.8	11.2	11.1	11.7	11	10.8	185
190				10.9	11.3		11.4	11.3	10.3	11.6	11.1	11.1	11.5	10.9	10.8	190
195				10.6	11.3		11.2	11.2	7.6	11.4	11.1	11.1	11.2	10.9	10.8	195
200				10.2	10.7		11	11.2	5.8	11.3	11.1	11.1	11	10.9	10.8	200
205							10.8	11.2		11.1	11	9.1	10.7	10.9	10.8	205
210							10.5	11.2		10.9	11	7	10.1	10.6	10.8	210
215							7.7	10.6		10.7	10.9	5.4	9.4	10.2	10.3	215
220										10.1	10.7		9	9.4	8.2	220
225										8.8	9.9		8.7	8.8	6.4	225
230										6	8.1		8.3	8.5	5.2	230
235											3		8	8.2		235
240													7	7.9		240
245													5.2	6.5		245
250														5.2		250

t\_240\_002\_50301\_00\_000 / 52301\_00\_000 / 54301\_00\_000

# Lifting capacities Forces de levage

TK

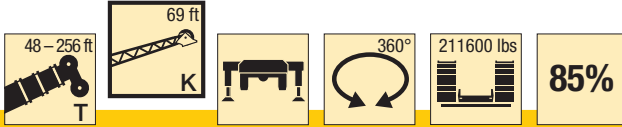

**Preliminary  
Préliminaire**

ft	208 ft			224 ft			240 ft			253 ft			256 ft			ft
	69 ft			69 ft			69 ft			69 ft			69 ft			
	0°	20°	40°	0°	20°	40°	0°	20°	40°	0°	20°	40°	0°	20°	40°	
45	15.8															45
50	15.9			14												50
55	15.9			14.1			12.2									55
60	15.8			14.1			12.2			10.6			10.4			60
65	15.7			14			12.2			10.6			10.4			65
70	15.6	14.1		14			12.2			10.7			10.4			70
75	15.5	13.9		13.8			12.1			10.7			10.5			75
80	15.2	13.6		13.7	12.6		12.1			10.7			10.4			80
85	15	13.4		13.6	12.5		12	11.3		10.6			10.4			85
90	14.8	13.2	11.7	13.4	12.3		11.9	11.2		10.6	10.2		10.4	10		90
95	14.6	13	11.5	13.2	12.1	11.1	11.8	11.1		10.5	10.1		10.3	10		95
100	14.4	12.8	11.4	13.1	12	11	11.7	11		10.4	10.1		10.3	9.9		100
105	14.2	12.6	11.3	13	11.9	10.9	11.6	10.9	10.3	10.4	10		10.2	9.8		105
110	14	12.4	11.2	12.8	11.7	10.8	11.5	10.8	10.3	10.3	9.9	9.6	10.1	9.8	9.5	110
115	13.8	12.3	11.1	12.7	11.6	10.7	11.4	10.7	10.2	10.2	9.8	9.5	10	9.7	9.4	115
120	13.6	12.1	11	12.5	11.5	10.6	11.2	10.6	10.1	10.1	9.6	9.4	10	9.5	9.3	120
125	13.4	12	11	12.4	11.4	10.6	11.1	10.5	10.1	10	9.4	9.2	9.9	9.4	9.1	125
130	13.2	11.8	10.9	12.2	11.2	10.5	10.9	10.4	10	9.8	9.2	8.9	9.7	9.1	8.9	130
135	13	11.7	10.8	12.1	11.1	10.5	10.8	10.2	9.9	9.5	9	8.7	9.5	8.9	8.7	135
140	12.8	11.5	10.8	11.9	11	10.5	10.6	10	9.7	9.2	8.7	8.5	9.2	8.7	8.5	140
145	12.6	11.4	10.7	11.8	10.9	10.4	10.4	9.8	9.5	9	8.5	8.3	8.9	8.5	8.3	145
150	12.4	11.3	10.7	11.6	10.8	10.4	10.2	9.6	9.3	8.7	8.3	8.1	8.7	8.3	8.1	150
155	12.2	11.2	10.7	11.5	10.7	10.4	10	9.3	9.1	8.5	8.1	7.9	8.4	8.1	7.9	155
160	12.1	11.1	10.6	11.3	10.6	10.3	9.7	9.1	8.9	8.2	7.9	7.8	8.2	7.9	7.8	160
165	11.9	11	10.6	11.1	10.5	10.3	9.5	8.9	8.8	8	7.7	7.6	7.9	7.7	7.6	165
170	11.8	10.9	10.6	10.8	10.4	10.3	9.2	8.7	8.6	7.7	7.6	7.5	7.7	7.5	7.5	170
175	11.6	10.9	10.6	10.5	10.2	10.3	8.9	8.5	8.4	7.4	7.4	7.3	7.4	7.4	7.3	175
180	11.4	10.8	10.6	10.2	10	10.2	8.7	8.3	8.2	7.2	7.2	7.2	7.2	7.2	7.2	180
185	11.1	10.7	10.6	9.9	9.8	10	8.5	8.1	8.1	7	7	7	6.9	7	7	185
190	10.8	10.7	10.6	9.6	9.6	9.8	8.2	8	7.9	6.8	6.8	6.9	6.7	6.8	6.9	190
195	10.6	10.6	10.6	9.3	9.3	9.6	7.9	7.8	7.8	6.6	6.7	6.8	6.5	6.6	6.7	195
200	10.3	10.5	10.6	9.1	9.1	9.3	7.7	7.6	7.6	6.4	6.5	6.6	6.3	6.4	6.6	200
205	9.9	10.2	10.5	8.8	8.8	9	7.5	7.5	7.5	6.2	6.3	6.4	6.2	6.2	6.4	205
210	9.5	9.8	10.2	8.5	8.5	8.7	7.3	7.3	7.4	6	6.1	6.2	6	6.1	6.2	210
215	9.1	9.5	9.9	8.2	8.3	8.5	7.1	7.1	7.2	5.8	5.9	6	5.8	5.9	6	215
220	8.6	9.1	9.4	7.9	8	8.3	6.9	6.9	7.1	5.6	5.7	5.9	5.6	5.7	5.8	220
225	7.9	8.7	8.9	7.6	7.7	8	6.7	6.8	6.9	5.5	5.5	5.7	5.3	5.5	5.7	225
230	7.3	8.1	8.4	7.3	7.5	7.7	6.5	6.6	6.8	5.3	5.4	5.5	5	5.3	5.5	230
235	7	7.5	7.5	6.9	7.2	7.4	6.3	6.4	6.6	5.1	5.2	5.4	4.7	5.2	5.3	235
240	6.8	7	6.1	6.5	6.9	7.1	6.1	6.3	6.4	5	5	5.2	4.5	5	5.1	240
245	6.6	6.7	5	6.1	6.6	6.8	5.9	6.1	6.2	4.8	4.9	5	4.2	4.7	4.8	245
250	6.4	6.5		5.7	6.2	6.3	5.7	5.9	6.1	4.6	4.7	4.9	3.9	4.4	4.5	250
255	5.7	6.2		5.5	5.7	5.7	5.4	5.7	5.9	4.4	4.6	4.7	3.6	4.1	4.2	255
260	4.9	5.4		5.4	5.4		4.9	5.4	5.6	4.2	4.4	4.5	3.3	3.7	3.9	260
265		3.4		5.2	5.3		4.4	5.1	5.3	4	4.2	4.4	3	3.4	3.5	265
270				4.7	5.1		3.9	4.5	4.6	3.7	4	4.1	2.7	3.1	3.2	270
275				2.8	4.5		3.3	3.9		3.3	3.8	3.9	2.4	2.8	2.9	275
280							2.9	3.4		2.5	3.4	3.5		2.5	2.5	280
285								2.8			2.9	2.9				285

t\_240\_002\_50301\_00\_000 / 52301\_00\_000 / 54301\_00\_000

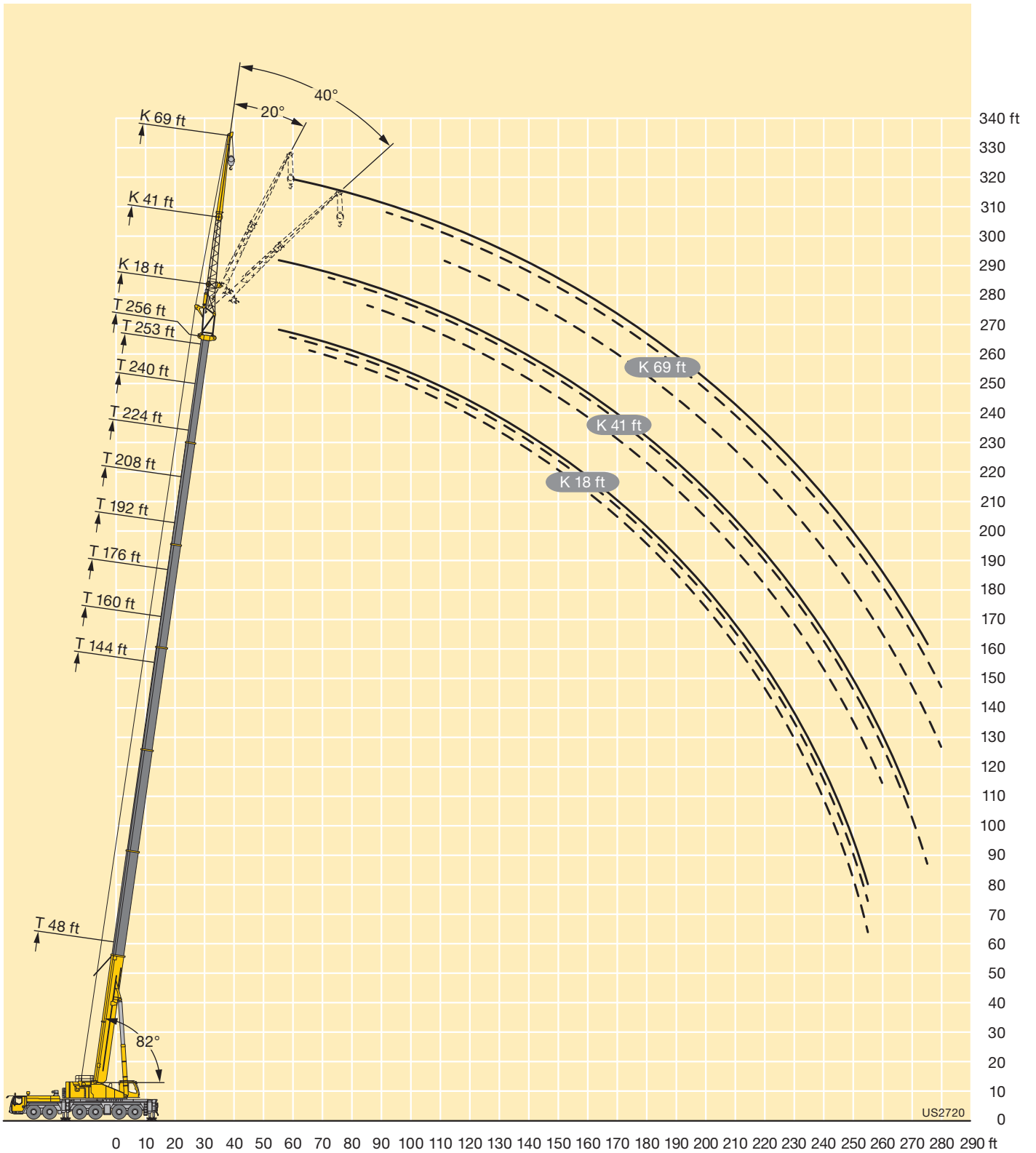

# Lifting capacities Forces de levage

TK

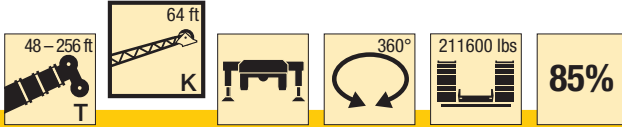

Preliminary  
Préliminaire

ft	48 ft			144 ft			160 ft			176 ft			192 ft			ft
	64 ft			64 ft			64 ft			64 ft			64 ft			
	0°	20°	40°	0°	20°	40°	0°	20°	40°	0°	20°	40°	0°	20°	40°	
12	31.4															12
13	31.4															13
14	31.4															14
15	31.4															15
16	31.2															16
17	31															17
18	30.7															18
19	30.5															19
20	30.2															20
22	29.6															22
24	29															24
26	28.4															26
28	27.7			31.4												28
30	27.1			31.4			27									30
32	26.4	22.9		31.4			27									32
34	25.8	22.3		31.3			27			24.9						34
36	25.2	21.6		31.1			27			24.9						36
38	24.6	21		30.9			27			24.9			22.1			38
40	24	20.4		30.6			27			25			22.1			40
45	22.6	19.1		29.8			27			25			22.1			45
50	21.2	17.9	15.1	29	22.7		26.9			25			22.2			50
55	19.7	16.9	14.3	28.1	21.9		26.7	22.3		24.7			22.1			55
60	18.2	16	13.7	27.3	21		26.1	21.7		24.3	20.9		21.9			60
65	16.9	15.2	13.1	26.4	20.3	15.4	25.5	21.2		23.9	20.4		21.6	19.3		65
70	15.6	14.5	12.6	25.6	19.6	15	25	20.6	15.9	23.4	19.9		21.3	18.9		70
75	14.5	13.8	12.2	24.8	18.9	14.7	24.3	20.1	15.7	23	19.5	15.5	21	18.6		75
80	13.6	13.2	11.9	24	18.3	14.3	23.7	19.6	15.4	22.5	19.1	15.2	20.7	18.2	14.9	80
85	12.7	12.7	11.7	23.2	17.8	14	23.1	19.1	15.1	22.1	18.7	14.9	20.4	17.9	14.6	85
90	11.9	12.2	11.6	22.4	17.2	13.7	22.5	18.6	14.8	21.6	18.2	14.7	20	17.5	14.4	90
95	11.3	11.8	11.6	21.7	16.7	13.4	21.9	18.1	14.5	21.1	17.8	14.4	19.7	17.2	14.2	95
100	10.7	11.6	5.1	20.9	16.2	13.1	21.4	17.6	14.3	20.7	17.4	14.2	19.4	16.8	14	100
105	10.3			20.1	15.8	12.9	20.8	17.1	14.1	20.2	17	14	19.1	16.5	13.8	105
110				19.3	15.4	12.7	20.3	16.7	13.9	19.8	16.6	13.8	18.8	16.2	13.6	110
115				18.5	15	12.5	19.8	16.3	13.7	19.4	16.2	13.6	18.4	15.9	13.4	115
120				17.7	14.7	12.3	19.3	15.9	13.5	18.9	15.9	13.4	18.1	15.5	13.3	120
125				17	14.3	12.1	18.8	15.6	13.3	18.5	15.6	13.3	17.8	15.2	13.1	125
130				16.3	14	12	18.3	15.3	13.2	18.1	15.2	13.1	17.5	15	13	130
135				15.6	13.7	11.9	17.8	14.9	13	17.7	15	13	17.2	14.7	12.8	135
140				15	13.4	11.8	17.3	14.6	12.9	17.3	14.7	12.9	16.8	14.4	12.8	140
145				14.5	13.1	11.7	16.9	14.3	12.8	16.9	14.4	12.8	16.5	14.2	12.7	145
150				14	12.9	11.7	16.4	14	12.8	16.5	14.1	12.7	16.2	14	12.6	150
155				13.5	12.6	11.6	15.9	13.8	12.7	16.1	13.9	12.7	15.9	13.7	12.5	155
160				13	12.3	11.6	15.4	13.5	12.6	15.7	13.6	12.6	15.5	13.5	12.5	160
165				12.5	12.1	11.6	14.9	13.3	12.6	15.3	13.3	12.6	15.1	13.3	12.4	165
170				12.1	12	11.6	14.4	13	12.6	14.9	13.1	12.5	14.7	13.1	12.4	170
175				11.8	11.8	8.7	13.9	12.8	12.6	14.5	12.9	12.5	14.2	12.9	12.3	175
180				11.4	11.7	6.3	13.5	12.6	12.6	14.1	12.7	12.5	13.8	12.7	12.3	180
185				11.1	11.6		13.1	12.5	10.6	13.7	12.5	12.4	13.3	12.5	12.3	185
190				10.8	11.6		12.7	12.3	7.6	13.3	12.4	12.4	12.7	12.3	12.3	190
195				10.5	11.1		12.3	12.3	5.8	12.8	12.3	11.8	12.2	12.1	12.3	195
200							12	12.2		12.4	12.2	9.1	11.3	11.8	12	200
205							11.5	12.2		11.9	11.9	7	10.5	11.4	11.6	205
210							8.2	10.9		11.2	11.6	5.5	9.7	10.6	10.6	210
215								3.8		10.5	11		9.4	9.7	8.2	215
220										9.3	10.2		9	9.2	6.5	220
225										6.3	8.4		8.7	8.8	5.2	225
230											3.4		8.3	8.5		230
235													7.4	8.1		235
240													5.4	6.8		240
245													4.1	5.4		245

t\_240\_002\_50201\_00\_000 / 52201\_00\_000 / 54201\_00\_000

# Lifting capacities Forces de levage

TK



**Preliminary**  
**Préliminaire**

ft	208 ft			224 ft			240 ft			253 ft			256 ft			ft	
	64 ft			64 ft			64 ft			64 ft			64 ft				
	0°	20°	40°	0°	20°	40°	0°	20°	40°	0°	20°	40°	0°	20°	40°		
45	19.2															45	
50	19.2			16.4												50	
55	19.3			16.4			13.8									55	
60	19.2			16.4			13.9				11.9			11.6		60	
65	19.1			16.4			13.9			11.9				11.6		65	
70	18.9	17.5		16.4			13.9			12				11.7		70	
75	18.7	17.2		16.3	15.5		13.9			12				11.7		75	
80	18.5	17		16.2	15.4		13.8			11.8				11.6		80	
85	18.3	16.7	14.2	16	15.2		13.7	13.2		11.7				11.5		85	
90	18.1	16.5	14	15.9	15.1		13.6	13.2		11.6	11.2			11.4	10.9	90	
95	17.9	16.2	13.8	15.7	14.9	13.1	13.5	13.1		11.5	11.2			11.3	10.9	95	
100	17.7	15.9	13.6	15.6	14.8	13	13.3	12.9	12.1	11.4	11.1			11.2	10.8	100	
105	17.4	15.7	13.4	15.4	14.6	12.9	13.2	12.6	12	11.2	10.9	10.5		11.1	10.7	10.4	105
110	17.2	15.4	13.2	15.2	14.4	12.8	13	12.2	11.7	11.1	10.6	10.2		10.9	10.5	10.2	110
115	17	15.2	13.1	15	14.2	12.6	12.8	11.9	11.4	10.9	10.3	10		10.7	10.2	9.9	115
120	16.8	14.9	13	14.8	14	12.5	12.5	11.6	11.2	10.7	10.1	9.7		10.6	10	9.7	120
125	16.6	14.7	12.8	14.6	13.8	12.4	12.2	11.3	10.9	10.5	9.8	9.5		10.4	9.7	9.4	125
130	16.3	14.4	12.7	14.3	13.6	12.3	11.8	11	10.6	10.2	9.6	9.3		10.1	9.5	9.2	130
135	16.1	14.2	12.6	14	13.4	12.2	11.5	10.7	10.4	9.9	9.3	9		9.8	9.2	9	135
140	15.9	14	12.5	13.7	13.2	12.2	11.2	10.5	10.1	9.6	9.1	8.8		9.5	9	8.8	140
145	15.6	13.8	12.4	13.2	12.9	12.1	10.9	10.2	9.9	9.3	8.9	8.6		9.2	8.8	8.6	145
150	15.2	13.6	12.4	12.8	12.6	12	10.6	9.9	9.7	9	8.6	8.4		8.9	8.6	8.4	150
155	14.8	13.4	12.3	12.4	12.2	11.9	10.4	9.7	9.5	8.7	8.4	8.2		8.6	8.4	8.2	155
160	14.3	13.2	12.2	12	11.8	11.7	10.1	9.5	9.2	8.4	8.2	8		8.3	8.2	8	160
165	13.9	12.9	12.2	11.6	11.5	11.5	9.8	9.2	9	8.1	8	7.8		8.1	7.9	7.8	165
170	13.4	12.7	12.1	11.2	11.1	11.2	9.5	9	8.9	7.8	7.8	7.7		7.8	7.7	7.7	170
175	13	12.5	12.1	10.9	10.8	10.9	9.2	8.8	8.7	7.5	7.5	7.5		7.5	7.5	7.5	175
180	12.5	12.2	12	10.5	10.5	10.6	9	8.6	8.5	7.2	7.3	7.3		7.2	7.3	7.3	180
185	12	11.9	11.9	10.1	10.1	10.3	8.7	8.4	8.3	7	7.1	7.2		7	7.1	7.1	185
190	11.4	11.6	11.7	9.8	9.8	10	8.4	8.2	8.2	6.8	6.9	7		6.8	6.9	7	190
195	10.9	11.3	11.6	9.5	9.5	9.7	8.1	8	8	6.6	6.7	6.8		6.6	6.7	6.8	195
200	10.4	10.9	11.1	9.2	9.2	9.4	7.8	7.9	7.9	6.4	6.5	6.6		6.4	6.5	6.6	200
205	10	10.4	10.7	8.9	8.9	9.1	7.6	7.7	7.7	6.2	6.3	6.4		6.2	6.3	6.4	205
210	9.5	9.9	10.2	8.6	8.6	8.8	7.4	7.4	7.5	6	6.1	6.2		6	6.1	6.2	210
215	8.9	9.5	9.7	8.3	8.3	8.6	7.2	7.2	7.3	5.8	5.9	6		5.8	5.9	6	215
220	8.3	9	9.2	7.9	8	8.3	7	7	7.1	5.7	5.7	5.9		5.5	5.7	5.9	220
225	7.6	8.4	8.7	7.6	7.7	8	6.7	6.8	6.9	5.5	5.5	5.7		5.2	5.5	5.7	225
230	7.3	7.7	7.5	7.2	7.4	7.7	6.5	6.6	6.8	5.3	5.4	5.5		4.9	5.3	5.5	230
235	7	7.1	6.1	6.8	7.1	7.3	6.3	6.5	6.6	5.2	5.2	5.3		4.6	5.1	5.3	235
240	6.8	6.9	5	6.3	6.8	7	6.1	6.3	6.4	5	5	5.2		4.3	4.8	5	240
245	6.6	6.6		5.9	6.3	6.5	5.8	6.1	6.2	4.8	4.9	5		4.1	4.5	4.7	245
250	6	6.4		5.7	5.8	5.8	5.6	5.9	6.1	4.6	4.7	4.9		3.8	4.2	4.4	250
255	5	5.6		5.5	5.6		5.1	5.6	5.8	4.4	4.6	4.7		3.5	3.8	4	255
260		3.6		5.4	5.4		4.6	5.3	5.4	4.1	4.4	4.5		3.2	3.5	3.7	260
265				4.9	5.3		4	4.7	4.8	3.8	4.1	4.3		2.9	3.2	3.3	265
270				3	4.6		3.5	4.1		3.3	3.9	4		2.6	2.9	3	270
275							3	3.5			3.5	3.6			2.6	2.6	275
280								2.9			2.5	2.6					280

t\_240\_002\_50201\_00\_000 / 52201\_00\_000 / 54201\_00\_000

# Lifting capacities Forces de levage

TK

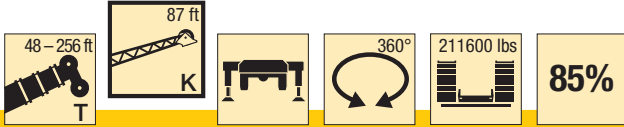

**Preliminary  
Préliminaire**

ft	48 ft			144 ft			160 ft			176 ft			192 ft			ft
	87 ft			87 ft			87 ft			87 ft			87 ft			
	0°	20°	40°	0°	20°	40°	0°	20°	40°	0°	20°	40°	0°	20°	40°	
14	19.4															14
15	19.4															15
16	19.4															16
17	19.4															17
18	19.4															18
19	19.5															19
20	19.4															20
22	19.3															22
24	19.1															24
26	18.9															26
28	18.5															28
30	18.2															30
32	17.8			19.4												32
34	17.5			19.4			18									34
36	17.1			19.5			18.1									36
38	16.8			19.5			18.1			16.5						38
40	16.4			19.4			18.1			16.6						40
45	15.6	13.5		19.2			18.1			16.6			14.9			45
50	14.8	12.7		18.8			17.8			16.5			15			50
55	14	11.9		18.3			17.5			16.4			14.9			55
60	13.1	11.2		17.8			17.1			16.1			14.7			60
65	12.4	10.6	8.9	17.2	13.4		16.6	13.1		15.7			14.5			65
70	11.6	10	8.5	16.7	12.9		16.2	12.7		15.4	12.4		14.3			70
75	10.9	9.5	8.1	16.2	12.4		15.8	12.3		15	12		14	11.6		75
80	10.3	9	7.8	15.7	12		15.3	11.9		14.7	11.7		13.7	11.3		80
85	9.7	8.5	7.5	15.2	11.5	8.7	14.9	11.5		14.3	11.3		13.4	11		85
90	9.1	8.2	7.3	14.8	11.1	8.5	14.5	11.1	8.5	14	11	8.4	13.2	10.7		90
95	8.6	7.8	7.1	14.3	10.8	8.3	14.1	10.8	8.3	13.6	10.7	8.2	12.9	10.4	8	95
100	8.2	7.5	6.9	13.8	10.5	8.1	13.7	10.5	8.1	13.3	10.4	8	12.6	10.1	7.9	100
105	7.8	7.3	6.8	13.3	10.1	8	13.3	10.2	7.9	13	10.1	7.9	12.3	9.8	7.8	105
110	7.4	7	6.8	12.9	9.8	7.8	12.9	9.9	7.8	12.6	9.8	7.7	12.1	9.6	7.6	110
115	7	6.9	6.8	12.4	9.5	7.6	12.5	9.6	7.6	12.3	9.6	7.6	11.8	9.3	7.5	115
120	6.7	6.8	6.8	12	9.3	7.5	12.1	9.3	7.5	12	9.3	7.5	11.5	9.1	7.4	120
125	6.5	6.8		11.5	9	7.4	11.7	9.1	7.4	11.6	9.1	7.4	11.3	8.9	7.3	125
130				11.1	8.8	7.3	11.4	8.8	7.3	11.3	8.8	7.2	11	8.7	7.2	130
135				10.7	8.5	7.2	11	8.6	7.2	11	8.6	7.1	10.7	8.5	7.1	135
140				10.3	8.3	7.1	10.6	8.4	7.1	10.7	8.4	7	10.4	8.3	7	140
145				10	8.1	7	10.2	8.2	7	10.4	8.2	7	10.2	8.2	6.9	145
150				9.6	7.9	6.9	9.9	8	6.9	10.1	8.1	6.9	9.9	8	6.8	150
155				9.3	7.8	6.9	9.6	7.9	6.9	9.8	7.9	6.8	9.7	7.8	6.8	155
160				9	7.6	6.8	9.3	7.7	6.8	9.5	7.7	6.8	9.4	7.7	6.7	160
165				8.8	7.4	6.8	9	7.6	6.8	9.2	7.6	6.7	9.2	7.5	6.7	165
170				8.5	7.3	6.8	8.8	7.4	6.8	9	7.4	6.7	8.9	7.4	6.6	170
175				8.2	7.2	6.8	8.5	7.3	6.7	8.7	7.3	6.7	8.7	7.3	6.6	175
180				7.9	7.1	6.8	8.3	7.2	6.7	8.5	7.2	6.6	8.5	7.2	6.6	180
185				7.7	7	6.8	8.1	7.1	6.7	8.2	7.1	6.6	8.3	7.1	6.6	185
190				7.5	6.9	6.8	7.9	7	6.7	8	7	6.6	8.1	7	6.5	190
195				7.2	6.9	6.8	7.6	6.9	6.7	7.9	6.9	6.6	7.9	6.9	6.5	195
200				7	6.8	6.8	7.4	6.9	6.7	7.7	6.9	6.6	7.7	6.8	6.5	200
205				6.9	6.8	5.4	7.3	6.8	6.7	7.5	6.8	6.6	7.6	6.8	6.5	205
210				6.7	6.8		7.1	6.8	6.7	7.4	6.7	6.6	7.5	6.7	6.5	210
215				6.6	6.8		6.9	6.8	6.5	7.2	6.7	6.6	7.3	6.7	6.5	215
220				6.1	6.8		6.8	6.8	5.1	7.1	6.7	6.6	7.2	6.6	6.5	220
225							6.6	6.8		6.9	6.7	6.6	7.1	6.6	6.5	225
230							6.5	6.8		6.8	6.6	6.2	6.9	6.6	6.5	230
235							4.4	6.6		6.6	6.6		6.8	6.6	6.5	235
240										6.6	6.6		6.7	6.6	6.5	240
245										5.7	6.6		6.6	6.6	5.9	245
250										2.8	5.1		6.5	6.5		250
255													6.2	6.4		255
260													4.4	6.2		260
265													3.9	4		265

t\_240\_002\_50401\_00\_000 / 52401\_00\_000 / 54401\_00\_000

# Lifting capacities Forces de levage

TK

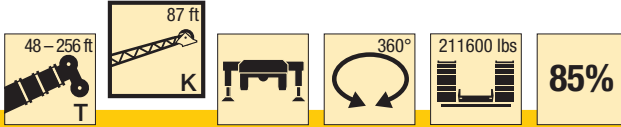

**Preliminary  
Préliminaire**

ft	208 ft			224 ft			240 ft			253 ft			256 ft			ft	
	87 ft			87 ft			87 ft			87 ft			87 ft				
	0°	20°	40°	0°	20°	40°	0°	20°	40°	0°	20°	40°	0°	20°	40°		
50	13.1															50	
55	13.1			11.2												55	
60	13.1			11.3			9.4									60	
65	13			11.3			9.5				7.8			7.5		65	
70	12.9			11.2			9.5				8.1			7.8		70	
75	12.7			11.1			9.5				8.2			7.9		75	
80	12.5	10.6		11			9.5				8.2			7.9		80	
85	12.3	10.4		10.9			9.4				8.1			7.9		85	
90	12.1	10.1		10.8	9.4		9.3				8			7.8		90	
95	11.9	9.9		10.6	9.2		9.2	8.4			7.9			7.7		95	
100	11.7	9.7		10.5	9		9.1	8.3			7.9	7.4		7.7		100	
105	11.4	9.4	7.6	10.3	8.8		9	8.1			7.8	7.3		7.6	7.3	105	
110	11.2	9.2	7.4	10.2	8.7	7.1	8.9	8			7.7	7.3		7.6	7.3	110	
115	11	9	7.3	10	8.5	7.1	8.8	7.9	6.7		7.7	7.3		7.5	7.2	115	
120	10.8	8.8	7.2	9.9	8.4	7	8.7	7.7	6.7		7.6	7.2		7.5	7.1	120	
125	10.6	8.6	7.1	9.7	8.2	6.9	8.6	7.6	6.7		7.6	7.1	6.4	7.5	7	6.4	125
130	10.4	8.5	7	9.6	8	6.8	8.5	7.5	6.6		7.6	7	6.4	7.4	6.9	6.3	130
135	10.2	8.3	7	9.4	7.9	6.8	8.4	7.4	6.5		7.5	6.9	6.3	7.4	6.9	6.3	135
140	10	8.1	6.9	9.3	7.8	6.7	8.3	7.3	6.5		7.4	6.8	6.3	7.3	6.8	6.2	140
145	9.8	8	6.8	9.1	7.6	6.7	8.2	7.2	6.4		7.2	6.8	6.2	7.1	6.7	6.2	145
150	9.5	7.8	6.7	9	7.5	6.6	8.1	7.1	6.4		7.1	6.7	6.2	7	6.6	6.2	150
155	9.3	7.7	6.7	8.8	7.4	6.5	8	7	6.4		6.9	6.6	6.1	6.9	6.5	6.1	155
160	9.1	7.5	6.6	8.6	7.3	6.5	7.8	6.9	6.3		6.8	6.4	6.1	6.7	6.4	6.1	160
165	8.9	7.4	6.6	8.5	7.2	6.5	7.6	6.8	6.3		6.7	6.3	6	6.6	6.3	6	165
170	8.7	7.3	6.5	8.3	7.1	6.4	7.4	6.7	6.2		6.5	6.2	6	6.4	6.1	5.9	170
175	8.5	7.2	6.5	8.1	7	6.4	7.3	6.7	6.2		6.3	6	5.9	6.3	6	5.9	175
180	8.3	7.1	6.5	8	6.9	6.4	7.1	6.6	6.2		6.1	5.9	5.8	6.1	5.9	5.8	180
185	8.1	7	6.4	7.8	6.8	6.3	6.9	6.5	6.2		6	5.7	5.7	5.9	5.7	5.7	185
190	8	6.9	6.4	7.7	6.7	6.3	6.8	6.4	6.2		5.8	5.6	5.6	5.7	5.6	5.5	190
195	7.8	6.8	6.4	7.5	6.7	6.3	6.6	6.3	6.1		5.6	5.5	5.5	5.5	5.5	5.4	195
200	7.7	6.7	6.4	7.4	6.6	6.3	6.5	6.2	6.1		5.4	5.4	5.4	5.3	5.4	5.3	200
205	7.5	6.7	6.4	7.2	6.5	6.3	6.3	6	6		5.2	5.3	5.3	5.2	5.3	5.2	205
210	7.4	6.6	6.4	7.1	6.5	6.3	6.2	5.9	5.9		5	5.1	5.2	5	5.1	5.2	210
215	7.2	6.6	6.4	6.9	6.5	6.3	6.1	5.8	5.8		4.8	5	5.1	4.8	5	5.1	215
220	7.1	6.5	6.4	6.8	6.4	6.3	5.9	5.7	5.7		4.7	4.8	5	4.6	4.8	4.9	220
225	6.9	6.5	6.4	6.6	6.4	6.3	5.8	5.6	5.6		4.5	4.7	4.8	4.5	4.7	4.8	225
230	6.8	6.5	6.4	6.5	6.3	6.3	5.6	5.5	5.6		4.3	4.5	4.7	4.3	4.5	4.7	230
235	6.7	6.4	6.4	6.3	6.2	6.3	5.4	5.4	5.5		4.1	4.3	4.6	4.1	4.3	4.6	235
240	6.4	6.4	6.4	6	6.1	6.3	5.3	5.3	5.4		4	4.2	4.4	3.8	4.1	4.4	240
245	6	6.3	6.4	5.8	6	6.2	5.1	5.2	5.3		3.8	4	4.3	3.6	4	4.3	245
250	5.6	6.1	6.4	5.5	5.8	6.1	4.9	5	5.2		3.6	3.9	4.1	3.3	3.8	4.1	250
255	5.4	5.8	6	5.1	5.6	5.8	4.7	4.9	5.1		3.5	3.7	3.9	3	3.6	3.9	255
260	5.2	5.4	5.5	4.6	5.4	5.5	4.5	4.8	4.9		3.3	3.6	3.8	2.8	3.3	3.7	260
265	5.1	5.2		4.4	5	5.2	4.2	4.6	4.8		3.1	3.4	3.6		3.1	3.3	265
270	4.9	5		4.2	4.4	4.6	3.9	4.5	4.6			3.2	3.4		2.8	3	270
275	3.7	4.8		4.1	4.2	4.4	3.4	4.2	4.4			3	3.2		2.5	2.7	275
280		3.6		4	4.1		2.8	3.8	4			2.8	3			2.3	280
285				3.8	3.9			3.3	3.4				2.6				285
290				2.3	3.8			2.4	2.5								290

t\_240\_002\_50401\_00\_000 / 52401\_00\_000 / 54401\_00\_000

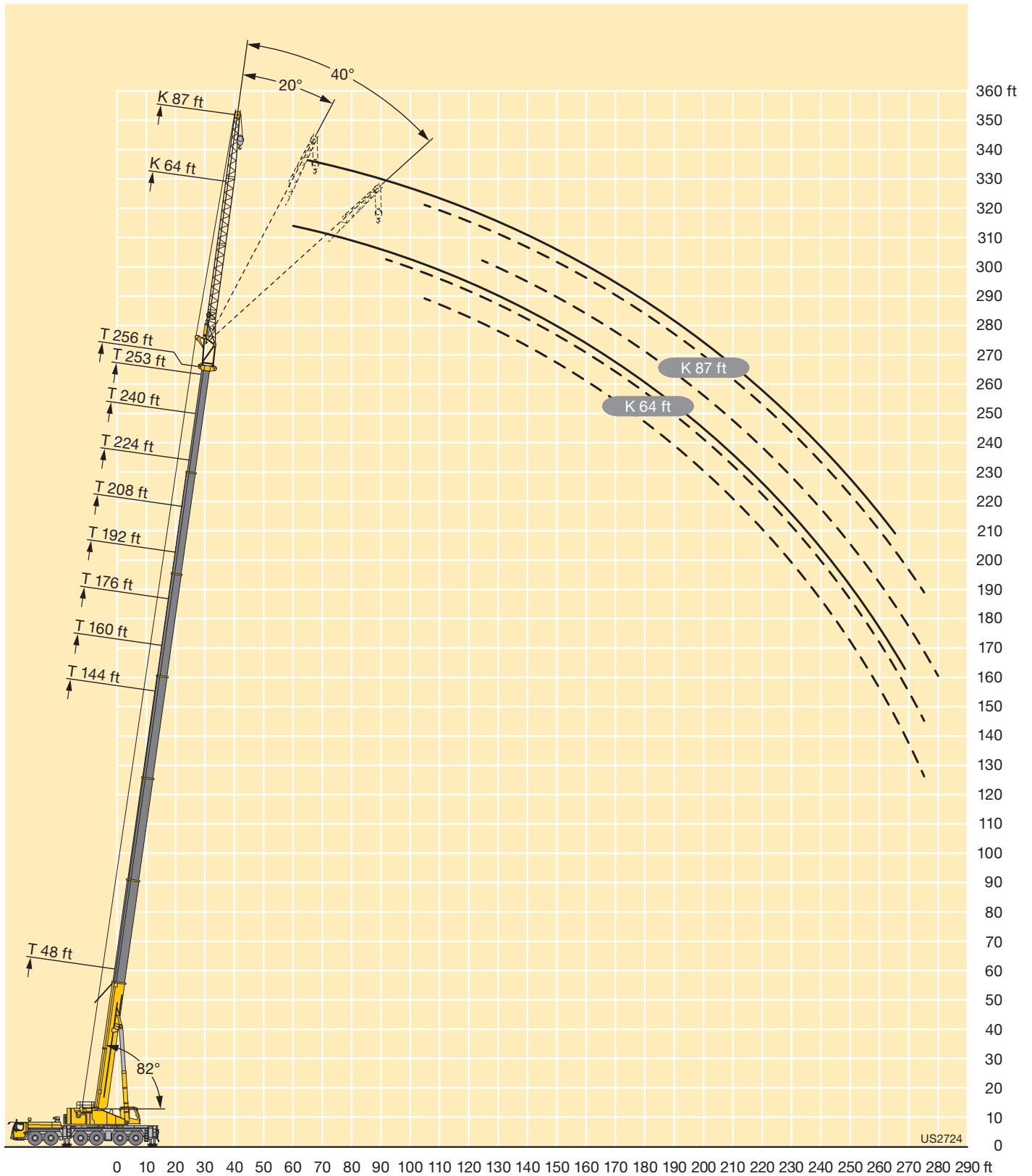



# Lifting capacities Forces de levage

TK



**Preliminary  
Préliminaire**

ft	48 ft			144 ft			160 ft			176 ft			192 ft			ft
	92 ft			92 ft			92 ft			92 ft			92 ft			
	0°	20°	40°	0°	20°	40°	0°	20°	40°	0°	20°	40°	0°	20°	40°	
15	15.9															15
16	15.9															16
17	15.9															17
18	15.9															18
19	15.9															19
20	16															20
22	15.9															22
24	15.9															24
26	15.8															26
28	15.6															28
30	15.4															30
32	15.2			15.4												32
34	15			15.8												34
36	14.8			15.9			14.9									36
38	14.5			16			15.1									38
40	14.3			15.9			15.2			14.1						40
45	13.7			15.9			15.2			14.2			12.9			45
50	13.1	11.6		15.7			15			14.2			13			50
55	12.5	10.9		15.4			14.8			14			13			55
60	11.9	10.3		15.1			14.6			13.8			12.9			60
65	11.2	9.7		14.8	12		14.3			13.6			12.7			65
70	10.6	9.2	7.8	14.4	11.6		14	11.5		13.3			12.5			70
75	10.1	8.8	7.5	14.1	11.2		13.7	11.1		13.1	10.9		12.3			75
80	9.5	8.3	7.2	13.7	10.8		13.4	10.7		12.8	10.5		12.1	10.2		80
85	9	8	7	13.4	10.5		13.1	10.4		12.6	10.2		11.9	9.9		85
90	8.5	7.6	6.8	13	10.1	7.8	12.8	10.1	7.8	12.3	9.9		11.6	9.7		90
95	8.1	7.3	6.7	12.6	9.8	7.6	12.5	9.8	7.6	12.1	9.7	7.5	11.4	9.4		95
100	7.7	7	6.5	12.3	9.5	7.5	12.2	9.5	7.4	11.8	9.4	7.4	11.2	9.2	7.2	100
105	7.3	6.8	6.4	11.9	9.2	7.3	11.9	9.3	7.3	11.5	9.1	7.2	11	8.9	7.1	105
110	7	6.6	6.3	11.5	9	7.2	11.5	9	7.2	11.3	8.9	7.1	10.8	8.7	7	110
115	6.7	6.5	6.3	11.2	8.7	7.1	11.2	8.8	7.1	11	8.7	7	10.6	8.5	6.9	115
120	6.5	6.4	6.3	10.8	8.5	7	10.9	8.5	6.9	10.7	8.5	6.9	10.4	8.3	6.8	120
125	6.2	6.3	6.3	10.5	8.2	6.9	10.6	8.3	6.8	10.4	8.3	6.8	10.1	8.1	6.7	125
130	6	6.3		10.1	8	6.8	10.3	8.1	6.7	10.2	8.1	6.7	9.9	8	6.6	130
135				9.8	7.8	6.7	9.9	7.9	6.7	9.9	7.9	6.6	9.7	7.8	6.6	135
140				9.4	7.6	6.6	9.7	7.7	6.6	9.7	7.7	6.6	9.4	7.6	6.5	140
145				9.2	7.4	6.5	9.3	7.5	6.5	9.4	7.5	6.5	9.2	7.5	6.4	145
150				8.8	7.3	6.5	9.1	7.4	6.4	9.1	7.4	6.4	9	7.3	6.4	150
155				8.6	7.2	6.4	8.8	7.2	6.4	8.9	7.3	6.4	8.8	7.2	6.3	155
160				8.3	7	6.4	8.6	7.1	6.3	8.6	7.1	6.3	8.6	7	6.3	160
165				8	6.9	6.3	8.3	7	6.3	8.4	7	6.3	8.4	6.9	6.2	165
170				7.8	6.8	6.3	8.1	6.9	6.3	8.2	6.9	6.2	8.2	6.8	6.1	170
175				7.6	6.7	6.3	7.8	6.7	6.2	8	6.8	6.2	7.9	6.7	6.1	175
180				7.4	6.6	6.3	7.6	6.7	6.2	7.8	6.7	6.1	7.8	6.6	6.1	180
185				7.2	6.5	6.3	7.5	6.6	6.2	7.6	6.6	6.1	7.6	6.6	6.1	185
190				7	6.4	6.3	7.3	6.5	6.2	7.4	6.5	6.1	7.4	6.5	6	190
195				6.8	6.4	6.3	7.1	6.4	6.2	7.2	6.4	6.1	7.3	6.4	6	195
200				6.7	6.3	6.3	7	6.4	6.2	7.1	6.4	6.1	7.1	6.4	6	200
205				6.5	6.3	6.3	6.8	6.3	6.2	7	6.3	6.1	7	6.3	6	205
210				6.4	6.3	5.4	6.7	6.3	6.2	6.8	6.3	6.1	6.9	6.2	6	210
215				6.2	6.3		6.6	6.2	6.2	6.7	6.2	6.1	6.8	6.2	6	215
220				6.1	6.3		6.4	6.2	6.2	6.6	6.2	6.1	6.7	6.1	6	220
225				5.7	6.3		6.3	6.2	5.1	6.5	6.2	6.1	6.6	6.1	6	225
230							6.2	6.2		6.4	6.2	6.1	6.5	6.1	6	230
235							6.1	6.2		6.3	6.2	6	6.4	6.1	6	235
240							4.1	6.2		6.2	6.2		6.3	6.1	6	240
245										6.1	6.2		6.2	6.1	6	245
250										5.4	6.2		6.1	6.1	5.7	250
255										2.6	4.9		6	6		255
260													5.9	6		260
265													4.1	6		265
270													3.8	3.9		270

t\_240\_002\_50501\_00\_000 / 52501\_00\_000 / 54501\_00\_000

# Lifting capacities Forces de levage

TK



**Preliminary  
Préliminaire**

ft	208 ft			224 ft			240 ft			253 ft			256 ft			ft
	92 ft			92 ft			92 ft			92 ft			92 ft			
	0°	20°	40°	0°	20°	40°	0°	20°	40°	0°	20°	40°	0°	20°	40°	
50	11.5															50
55	11.5			9.9												55
60	11.5			10.1			8.2									60
65	11.5			10.2			8.5			6.9						65
70	11.4			10.1			8.7			7.2			6.9			70
75	11.2			10			8.7			7.4			7.2			75
80	11.1			9.9			8.6			7.5			7.3			80
85	10.9	9.4		9.8			8.5			7.5			7.4			85
90	10.7	9.2		9.7	8.5		8.4			7.5			7.3			90
95	10.6	9		9.6	8.4		8.4			7.4			7.3			95
100	10.4	8.8		9.4	8.2		8.3	7.5		7.4			7.3			100
105	10.3	8.6		9.3	8.1		8.2	7.4		7.3	6.9		7.2	6.8		105
110	10.1	8.4	6.9	9.2	7.9		8.1	7.3		7.3	6.8		7.2	6.8		110
115	9.9	8.2	6.8	9.1	7.7	6.6	8	7.2		7.2	6.8		7.1	6.7		115
120	9.7	8	6.7	8.9	7.6	6.5	7.9	7.1	6.2	7.2	6.7		7	6.6		120
125	9.6	7.9	6.6	8.8	7.5	6.4	7.8	7	6.2	7.1	6.6		7	6.5		125
130	9.4	7.7	6.5	8.7	7.3	6.3	7.7	6.9	6.1	7	6.5	5.9	6.9	6.5	5.8	130
135	9.2	7.6	6.4	8.6	7.2	6.3	7.7	6.8	6.1	7	6.4	5.9	6.9	6.4	5.8	135
140	9	7.4	6.4	8.4	7.1	6.2	7.6	6.7	6	6.9	6.4	5.8	6.8	6.3	5.8	140
145	8.8	7.3	6.3	8.3	7	6.2	7.5	6.6	6	6.8	6.3	5.8	6.7	6.2	5.8	145
150	8.7	7.1	6.3	8.1	6.9	6.1	7.4	6.6	5.9	6.7	6.2	5.7	6.6	6.2	5.7	150
155	8.5	7	6.2	8	6.8	6.1	7.3	6.5	5.9	6.6	6.2	5.7	6.5	6.1	5.7	155
160	8.3	6.9	6.2	7.9	6.7	6	7.2	6.4	5.9	6.5	6.1	5.7	6.4	6.1	5.7	160
165	8.1	6.8	6.1	7.7	6.6	6	7.1	6.3	5.8	6.4	6	5.7	6.4	6	5.6	165
170	7.9	6.7	6.1	7.6	6.5	5.9	7	6.3	5.8	6.3	5.9	5.6	6.2	5.9	5.6	170
175	7.8	6.7	6	7.4	6.4	5.9	6.9	6.2	5.8	6.2	5.8	5.6	6.1	5.8	5.6	175
180	7.6	6.6	6	7.3	6.4	5.9	6.8	6.1	5.7	6	5.7	5.6	6	5.7	5.6	180
185	7.4	6.5	6	7.2	6.3	5.9	6.7	6.1	5.7	5.8	5.6	5.5	5.8	5.6	5.5	185
190	7.3	6.4	5.9	7.1	6.2	5.8	6.6	6	5.7	5.7	5.5	5.4	5.6	5.5	5.4	190
195	7.1	6.3	5.9	7	6.2	5.8	6.5	6	5.7	5.5	5.4	5.3	5.5	5.4	5.3	195
200	7	6.3	5.9	6.8	6.1	5.8	6.3	5.9	5.7	5.3	5.3	5.3	5.3	5.3	5.2	200
205	6.9	6.2	5.9	6.7	6.1	5.8	6.2	5.8	5.7	5.1	5.2	5.2	5.1	5.1	5.2	205
210	6.8	6.2	5.9	6.6	6	5.8	6.1	5.7	5.7	5	5	5.1	4.9	5	5.1	210
215	6.7	6.1	5.9	6.5	6	5.8	5.9	5.6	5.6	4.8	4.9	5	4.8	4.9	5	215
220	6.6	6	5.9	6.5	5.9	5.8	5.8	5.5	5.6	4.6	4.8	4.9	4.6	4.7	4.9	220
225	6.5	6	5.9	6.4	5.9	5.8	5.7	5.5	5.5	4.5	4.6	4.8	4.4	4.6	4.8	225
230	6.4	6	5.9	6.3	5.9	5.8	5.5	5.4	5.4	4.3	4.5	4.7	4.3	4.5	4.7	230
235	6.4	6	5.9	6.2	5.8	5.8	5.4	5.3	5.4	4.1	4.3	4.6	4.1	4.3	4.6	235
240	6.3	5.9	5.9	6	5.8	5.8	5.2	5.2	5.3	4	4.2	4.5	3.9	4.1	4.4	240
245	6.1	5.9	5.9	5.8	5.7	5.8	5.1	5.1	5.2	3.8	4	4.3	3.7	4	4.3	245
250	5.8	5.9	5.9	5.6	5.7	5.8	4.9	5	5.1	3.7	3.9	4.1	3.4	3.8	4.1	250
255	5.4	5.8	5.9	5.3	5.6	5.8	4.7	4.9	5	3.5	3.7	4	3.2	3.6	4	255
260	5.3	5.6	5.8	4.9	5.5	5.7	4.5	4.7	4.9	3.3	3.6	3.8	2.9	3.4	3.8	260
265	5.1	5.2	5.3	4.4	5.2	5.4	4.3	4.6	4.8	3.2	3.4	3.6	2.6	3.2	3.5	265
270	4.9	5.1		4.2	4.8	5	4.1	4.5	4.6	3	3.3	3.5	2.4	3	3.2	270
275	4.7	4.9		4.1	4.2	4.4	3.7	4.3	4.4	2.7	3.1	3.3		2.7	2.9	275
280	3.6	4.7		3.9	4.1	4.2	3.2	4.1	4.2		2.9	3.1		2.4	2.5	280
285		3.5		3.8	4		2.8	3.7	3.8		2.8	3			2.2	285
290				3.6	3.8		2.1	3.1	3.3			2.7				290
295					3.6			2.6	2.7							295

t\_240\_002\_50501\_00\_000 / 52501\_00\_000 / 54501\_00\_000

# Lifting capacities Forces de levage

TK



**Preliminary  
Préliminaire**

ft	48 ft			144 ft			160 ft			176 ft			192 ft			ft
	115 ft			115 ft			115 ft			115 ft			115 ft			
	0°	20°	40°	0°	20°	40°	0°	20°	40°	0°	20°	40°	0°	20°	40°	
19	9.1															19
20	9.1															20
22	9.2															22
24	10.1															24
26	10.8															26
28	11.2															28
30	11.1															30
32	10.9															32
34	10.8															34
36	10.6			9.3												36
38	10.5			9.7												38
40	10.3			10			9.1									40
45	9.9			10.7			9.8			8.7						45
50	9.5			11			10.3			9.2			7.8			50
55	9			10.9			10.4			9.6			8.3			55
60	8.6	7.4		10.7			10.3			9.7			8.7			60
65	8.2	7		10.4			10			9.5			8.8			65
70	7.7	6.6		10.2			9.8			9.4			8.7			70
75	7.2	6.3		9.9			9.6			9.2			8.6			75
80	6.8	6		9.7	7.3		9.4	7.2		9			8.4			80
85	6.5	5.7		9.4	7.1		9.2	7		8.8	6.9		8.2			85
90	6.1	5.5	4.8	9.1	6.9		8.9	6.8		8.6	6.7		8.1	6.4		90
95	5.8	5.2	4.6	8.8	6.6		8.7	6.6		8.4	6.5		7.9	6.3		95
100	5.6	5	4.5	8.6	6.4		8.4	6.4		8.2	6.3		7.7	6.2		100
105	5.3	4.8	4.3	8.3	6.2	4.6	8.2	6.2		7.9	6.1		7.5	6		105
110	5.1	4.6	4.2	8	6.1	4.5	7.9	6	4.5	7.7	6		7.4	5.8		110
115	4.9	4.4	4.1	7.7	5.9	4.5	7.7	5.9	4.5	7.5	5.8	4.4	7.2	5.7		115
120	4.7	4.3	3.9	7.4	5.7	4.4	7.4	5.7	4.4	7.3	5.7	4.4	7	5.6	4.3	120
125	4.5	4.1	3.9	7.1	5.6	4.4	7.2	5.6	4.4	7.1	5.5	4.3	6.8	5.4	4.2	125
130	4.3	4	3.8	6.9	5.4	4.3	6.9	5.4	4.3	6.9	5.4	4.2	6.7	5.3	4.2	130
135	4.2	3.9	3.8	6.6	5.3	4.2	6.7	5.3	4.2	6.7	5.3	4.2	6.5	5.2	4.1	135
140	4	3.8	3.8	6.4	5.1	4.2	6.5	5.2	4.2	6.5	5.1	4.2	6.3	5.1	4.1	140
145	3.9	3.8	3.8	6.2	5	4.2	6.3	5	4.2	6.3	5	4.1	6.2	5	4	145
150	3.8	3.8		6	4.9	4.1	6.1	4.9	4.1	6.1	4.9	4.1	6	4.8	4	150
155	3.7	3.8		5.8	4.8	4.1	5.9	4.8	4	6	4.8	4	5.9	4.7	4	155
160				5.7	4.7	4	5.8	4.7	4	5.8	4.7	4	5.7	4.6	3.9	160
165				5.5	4.6	3.9	5.6	4.6	3.9	5.7	4.6	3.9	5.6	4.6	3.9	165
170				5.3	4.5	3.9	5.5	4.5	3.9	5.5	4.5	3.9	5.5	4.5	3.8	170
175				5.2	4.4	3.9	5.3	4.4	3.8	5.3	4.4	3.8	5.3	4.4	3.8	175
180				5	4.3	3.8	5.2	4.3	3.8	5.2	4.3	3.8	5.2	4.3	3.7	180
185				4.9	4.2	3.8	5	4.2	3.8	5.1	4.3	3.7	5.1	4.2	3.7	185
190				4.8	4.1	3.8	4.9	4.2	3.8	5	4.2	3.7	4.9	4.2	3.7	190
195				4.7	4	3.8	4.8	4.1	3.7	4.9	4.1	3.7	4.8	4.1	3.6	195
200				4.5	4	3.8	4.7	4	3.7	4.7	4	3.7	4.7	4	3.6	200
205				4.4	3.9	3.8	4.6	4	3.7	4.6	4	3.6	4.6	4	3.6	205
210				4.3	3.9	3.8	4.4	3.9	3.7	4.5	3.9	3.6	4.5	3.9	3.6	210
215				4.2	3.8	3.8	4.3	3.9	3.7	4.4	3.9	3.6	4.4	3.8	3.6	215
220				4.1	3.8	3.8	4.2	3.8	3.7	4.3	3.8	3.6	4.3	3.8	3.6	220
225				4	3.8	3.8	4.2	3.8	3.7	4.3	3.8	3.6	4.2	3.8	3.6	225
230				4	3.8	3.8	4.1	3.7	3.7	4.2	3.7	3.6	4.2	3.7	3.6	230
235				3.9	3.8		4	3.7	3.7	4.1	3.7	3.6	4.1	3.7	3.6	235
240				3.8	3.8		3.9	3.7	3.7	4	3.7	3.6	4	3.6	3.6	240
245				3.8	3.8		3.9	3.7		3.9	3.7	3.6	4	3.6	3.6	245
250							3.8	3.7		3.9	3.6	3.6	3.9	3.6	3.6	250
255							3.7	3.7		3.8	3.6	3.6	3.8	3.6	3.6	255
260							3.7	3.7		3.7	3.6		3.8	3.6	3.6	260
265										3.7	3.6		3.7	3.6	3.6	265
270										3.7	3.6		3.7	3.6	3.6	270
275										2.5	3.6		3.6	3.6		275
280													3.6	3.6		280
285													3.3	3.6		285
290													2.4	3.4		290
295														2.5		295

t\_240\_002\_50601\_00\_000 / 52601\_00\_000 / 54601\_00\_000

# Lifting capacities Forces de levage

TK

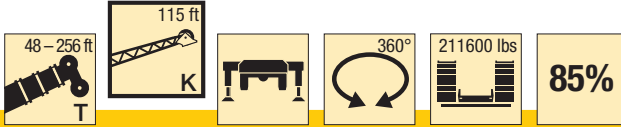

**Preliminary**  
**Préliminaire**

ft	208 ft			224 ft			240 ft			253 ft			256 ft		ft
	115 ft			115 ft			115 ft			115 ft			115 ft		
	0°	20°	40°	0°	20°	40°	0°	20°	40°	0°	20°	40°	0°	20°	
55	6.7														55
60	7.1			5.6											60
65	7.5			5.9			4.6								65
70	7.6			6.3			4.8								70
75	7.7			6.5			5.1			4			3.8		75
80	7.6			6.6			5.3			4			3.8		80
85	7.5			6.6			5.4			4.1			3.8		85
90	7.3			6.6			5.5			4.2			3.8		90
95	7.2			6.6			5.6			4.3			3.8		95
100	7.1	5.9		6.5			5.6			4.3			3.9		100
105	7	5.8		6.4	5.4		5.6			4.3			3.9		105
110	6.8	5.6		6.3	5.3		5.6			4.3			3.9		110
115	6.7	5.5		6.2	5.2		5.5	4.7		4.3			3.9		115
120	6.6	5.4		6.1	5.1		5.5	4.7		4.4	4.2		3.9	4.1	120
125	6.5	5.3	4.1	6	5		5.4	4.7		4.4	4.2		3.9	4.1	125
130	6.3	5.1	4	5.9	4.9		5.3	4.6		4.4	4.2		3.9	4.1	130
135	6.2	5	4	5.8	4.8	3.8	5.3	4.5		4.4	4.2		3.9	4.1	135
140	6.1	4.9	4	5.6	4.7	3.8	5.2	4.4	3.6	4.4	4.1		3.9	4	140
145	5.9	4.8	3.9	5.5	4.6	3.8	5.1	4.4	3.6	4.3	4.1		3.9	4	145
150	5.8	4.7	3.9	5.4	4.5	3.8	5	4.3	3.6	4.3	4	3.4	3.9	4	150
155	5.7	4.6	3.9	5.3	4.4	3.7	4.9	4.2	3.6	4.2	4	3.4	3.9	4	155
160	5.5	4.5	3.8	5.2	4.4	3.7	4.8	4.1	3.5	4.2	3.9	3.4	3.9	3.9	160
165	5.4	4.4	3.8	5.1	4.3	3.7	4.8	4.1	3.5	4.2	3.9	3.3	3.9	3.9	165
170	5.3	4.4	3.8	5	4.2	3.6	4.7	4	3.5	4.1	3.8	3.3	3.8	3.8	170
175	5.2	4.3	3.7	4.9	4.2	3.6	4.6	4	3.5	4.1	3.8	3.3	3.8	3.8	175
180	5	4.2	3.7	4.8	4.1	3.6	4.5	3.9	3.5	4	3.7	3.3	3.7	3.7	180
185	4.9	4.1	3.6	4.7	4	3.6	4.5	3.8	3.4	4	3.7	3.3	3.7	3.7	185
190	4.9	4.1	3.6	4.7	3.9	3.5	4.4	3.8	3.4	3.9	3.6	3.3	3.7	3.6	190
195	4.8	4	3.6	4.6	3.9	3.5	4.3	3.7	3.4	3.9	3.6	3.3	3.6	3.6	195
200	4.6	4	3.5	4.5	3.9	3.5	4.2	3.7	3.4	3.8	3.5	3.3	3.6	3.5	200
205	4.5	3.9	3.5	4.4	3.8	3.5	4.2	3.6	3.4	3.7	3.5	3.3	3.6	3.5	205
210	4.4	3.8	3.5	4.3	3.8	3.4	4.1	3.6	3.4	3.7	3.5	3.3	3.5	3.4	210
215	4.4	3.8	3.5	4.3	3.7	3.4	4	3.6	3.3	3.6	3.4	3.2	3.5	3.4	215
220	4.3	3.8	3.5	4.2	3.7	3.4	4	3.5	3.3	3.5	3.4	3.2	3.5	3.4	220
225	4.2	3.7	3.5	4.1	3.6	3.4	3.9	3.5	3.3	3.4	3.3	3.2	3.3	3.4	225
230	4.1	3.7	3.5	4	3.6	3.4	3.9	3.5	3.3	3.2	3.3	3.2	3.2	3.3	230
235	4.1	3.6	3.5	4	3.5	3.4	3.8	3.4	3.3	3.1	3.2	3.2	3.1	3.2	235
240	4	3.6	3.5	3.9	3.5	3.4	3.8	3.4	3.3	2.9	3.1	3.2	2.9	3.1	240
245	3.9	3.6	3.5	3.9	3.5	3.4	3.7	3.4	3.3	2.8	3	3.2	2.8	3	245
250	3.9	3.5	3.5	3.8	3.4	3.4	3.6	3.4	3.3	2.6	2.9	3.1	2.6	2.9	250
255	3.8	3.5	3.5	3.7	3.4	3.4	3.5	3.3	3.3	2.5	2.8	3.1	2.5	2.8	255
260	3.8	3.5	3.5	3.7	3.4	3.4	3.5	3.3	3.3	2.3	2.7	3	2.3	2.6	260
265	3.7	3.5	3.5	3.6	3.4	3.4	3.4	3.3	3.3	2.2	2.5	2.8		2.5	265
270	3.7	3.5	3.5	3.5	3.4	3.4	3.3	3.3	3.3		2.4	2.7		2.4	270
275	3.6	3.5	3.5	3.4	3.4	3.4	3.2	3.2	3.3		2.2	2.5		2.2	275
280	3.5	3.5	3.5	3.2	3.3	3.4	3	3.1	3.3			2.4			280
285	3.5	3.5		2.9	3.3	3.4		3.1	3.3			2.2			285
290	3.5	3.5		2.8	3.2	3.4		3	3.3						290
295	3.3	3.5		2.6	2.8	3.2		2.8	3.1						295
300	2.2	3.4		2.5	2.7				2.7						300
305		2.6			2.6										305
310					2.4										310

t\_240\_002\_50601\_00\_000 / 52601\_00\_000 / 54601\_00\_000

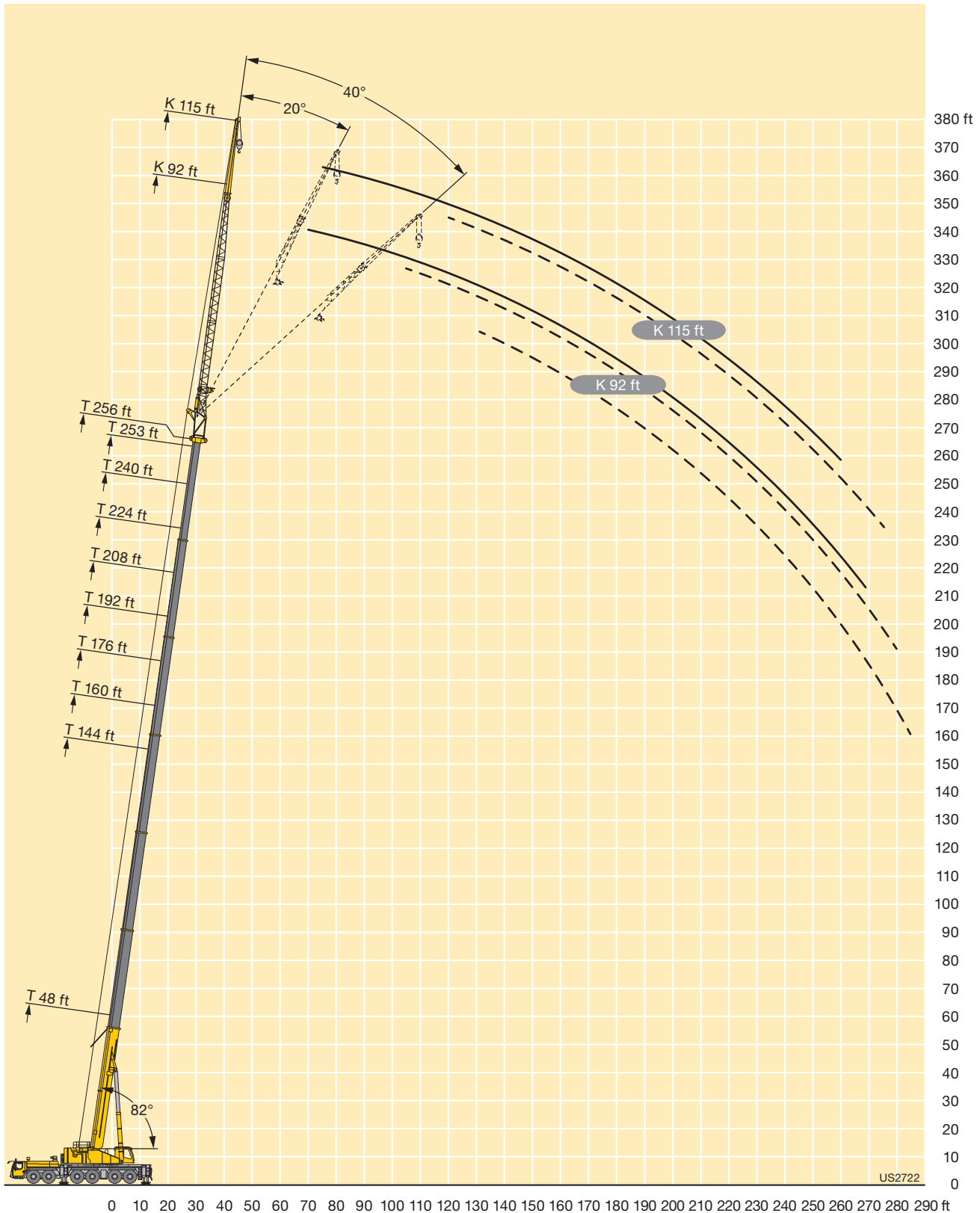

# Lifting capacities Forces de levage

**TNZK**

48-256 ft  
18 ft  
360°  
211600 lbs  
85%

**Preliminary  
Préliminaire**

ft	48 ft			64 ft			80 ft			96 ft			112 ft			128 ft			144 ft			160 ft			ft
	18 ft			18 ft			18 ft			18 ft			18 ft			18 ft			18 ft			18 ft			
	0°	20°	40°	0°	20°	40°	0°	20°	40°	0°	20°	40°	0°	20°	40°	0°	20°	40°	0°	20°	40°	0°	20°	40°	
12	128.3	101.2																						12	
13	125.9	99.2	84.3	130.9	103																			13	
14	122.7	97.2	82.9	130.3	101.1		130.4																	14	
15	119.5	95.3	81.7	127.6	99.4	83.9	129.2	100.7																15	
16	116.3	93.5	80.5	124.9	97.8	82.8	127.4	99.6	126.8															16	
17	113.7	91.8	79.3	122.4	96.2	81.8	125.2	98.2	125.1															17	
18	111.2	90.1	78.2	120	94.7	80.8	123.1	96.8	81.8	123.4	97.5		121.2											18	
19	108.6	88.4	77.1	117.6	93.3	79.9	121	95.5	81	121.7	96.4		119.9											19	
20	106	87	76.1	115.2	91.9	78.9	119	94.2	80.2	120	95.3		118.6											20	
22	101.2	84	74	110.7	89.2	77.1	115.1	91.7	78.5	116.6	93	79.4	115.9	93.5		105.6								22	
24	96.9	81.1	72.2	106.7	86.4	75.3	111.2	89.2	77	113.1	90.8	77.9	113.1	91.5	78.3	105.6	91.1							24	
26	92.9	78.6	70.4	102.6	84.1	73.6	107.5	87	75.4	109.9	88.7	76.5	110.2	89.5	77	105.3	89.6		95.2					26	
28	89.2	76.1	68.8	98.8	81.8	72.2	104.2	84.8	74.1	106.9	86.7	75.2	107.5	87.6	75.8	104.7	88.2	76.8	94.7	83.6				28	
30	86	73.8	67.3	95.4	79.5	70.8	101.1	82.8	72.7	103.9	84.8	73.9	104.8	85.8	74.6	103.9	86.9	75.8	94.2	82.7		79.4		30	
32	82.8	71.9	65.9	92.3	77.5	69.4	98	81	71.4	100.9	83	72.8	102.4	84.2	73.5	102.4	85.6	74.8	93.4	81.7	73	79.4		32	
34	79.9	70.1	64.7	89.2	75.6	68.2	95.1	79.2	70.2	98.5	81.2	71.6	100.1	82.6	72.4	100.8	84.3	73.9	92.4	80.7	72.2	79.3	73.9	34	
36	77.4	68.3	63.6	86.5	73.8	67	92.4	77.5	69.1	96.1	79.6	70.5	97.8	81.1	71.4	99.1	83.1	73	91.5	79.8	71.4	79	73.3	67.7	36
38	74.9	66.7	62.6	84.1	72.1	65.9	89.9	75.9	68	93.7	78.2	69.5	95.6	79.7	70.5	97.4	81.8	72.2	90.4	78.8	70.7	78.6	72.7	67.2	38
40	72.6	65.2	61.7	81.7	70.7	64.9	87.6	74.3	67	91.4	76.8	68.5	93.6	78.2	69.5	95.7	80.6	71.3	89.3	77.9	69.9	78.2	72	66.6	40
45	67.9	62.2	60.1	76.3	67.2	62.7	82.3	70.8	64.8	86.3	73.3	66.3	88.9	75.2	67.4	91.6	77.6	69.4	86.3	75.4	68.2	76.5	70.2	65.2	45
50	64.1	59.9	59.4	71.7	64.3	60.9	77.7	67.9	62.9	81.8	70.4	64.3	84.4	72.3	65.5	88	75	67.5	83.1	73.2	66.6	73.6	67.9	63.7	50
55	60.5	58.2	9.1	68	61.9	59.7	73.7	65.2	61.2	78	67.8	62.6	80.7	69.7	63.8	84.3	72.5	66	78.7	71	65.1	69.8	65.1	61.7	55
60				64.7	59.9	32.6	70.2	63	59.9	74.4	65.6	61.2	77.2	67.3	62.2	81.2	70.2	64.4	73.8	69	63.8	66.1	62.3	59.3	60
65				62.2	58.8	16	67.2	61.1	58.9	71.2	63.4	59.9	74.2	65.3	60.9	78.2	68.3	63.1	69.1	66.9	62.6	62.5	59.9	57.1	65
70				59.3	57.5	9.5	64.5	59.6	47.6	68.4	61.7	59	71.4	63.5	59.8	74.8	66.5	61.9	64.9	64.3	61	59	57.5	55.1	70
75				41.9			62.3	58.4	22.2	65.9	60.1	58.1	68.9	61.7	58.8	68.5	64.9	60.9	60.9	60.6	58.8	55.6	55.1	53.1	75
80							60.5	57.8	13.8	63.9	58.9	57.8	64.2	60.4	58	62.6	63	60.1	57.1	56.9	56.4	52.7	52.5	51.1	80
85							58.2	55.9	9.2	60.2	57.8	29	59	59	57.4	57.3	57.9	58	53.7	53.6	53.6	49.9	49.8	49	85
90							40.8	13.5		55.6	55.9	18.1	54.4	54.8	55	52.7	53.3	53.5	51.4	50.4	50.5	47.2	47.2	46.9	90
95										51.5	51.8	12.5	50.2	50.6	37.1	48.6	49.1	49.3	49.3	47.1	47.4	44.9	44.8	44.8	95
100										47.9	44.9	9	46.6	46.9	22.6	44.9	45.3	45.5	46.2	45.1	44.3	42.6	42.6	42.6	100
105										35.8	15.6	5.7	43.3	43.5	15.8	43.1	41.9	40.7	42.9	43.1	42.9	40.3	40.4	40.5	105
110													40.3	40.5	11.7	41.4	40.2	27.7	39.9	40.2	40.4	38.2	38.2	38.3	110
115													37.6	37.7	8.9	38.9	39	19.2	37.1	37.4	37.6	35.5	35.9	36.1	115
120													31	17	6.3	36.4	36.6	14.4	34.6	34.9	32.4	33	33.3	33.5	120
125																34.1	34.3	11.2	32.3	32.5	22.8	31.3	31.4	31.5	125
130																32	32.1	8.8	30.2	30.4	17.2	29.5	29.8	29.9	130
135																25	18.2	6.6	28.2	28.3	13.5	27.5	27.7	26.7	135
140																			26.3	26.4	10.8	25.6	25.8	20.1	140
145																			24.6	24.7	8.7	23.8	24	15.8	145
150																			20.7	19	6.9	22.2	22.4	12.7	150
155																						20.7	20.9	10.5	155
160																						19.4	19.4	8.6	160
165																						16.4	16.4	7	165
170																						10.5	9.4		170

t\_240\_002\_56001\_00\_000

# Lifting capacities Forces de levage

**TNZK**

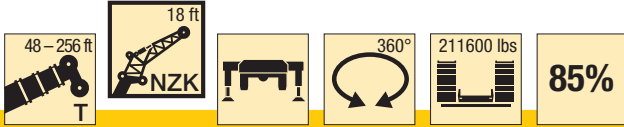

**Preliminary  
Préliminaire**

ft	176 ft			192 ft			208 ft			224 ft			240 ft			253 ft			256 ft			ft
	18 ft			18 ft			18 ft			18 ft			18 ft			18 ft			18 ft			
	0°	20°	40°	0°	20°	40°	0°	20°	40°	0°	20°	40°	0°	20°	40°	0°	20°	40°	0°	20°	40°	
34	64.7																					34
36	64.5																					36
38	64.2	64.7		51.5																		38
40	64	64.5		51.3																		40
45	63.2	63.7	61	50.8	51.2	51.4	41.6															45
50	62.2	62.8	60	50.3	50.7	51.2	41.3	41.5	42.2	34			25.4									50
55	60.7	60.6	58.7	49.7	50	50.5	40.9	41.2	41.3	33.8	33.8	34.1	25.3	25.4		21				20.4		55
60	57.9	57.8	56.7	48.7	48.8	49	40.3	40.1	40.2	33.2	33.2	33.5	25.1	25.2	25.1	21	21			20.4	20.4	60
65	55	54.9	54.4	46.9	47	47.2	39.1	38.9	39	32.5	32.4	32.6	24.9	24.9	25	20.9	20.9	20.9	20.3	20.3	20.3	65
70	52.2	52.2	52.1	44.9	45	45.3	37.9	37.7	37.7	31.6	31.4	31.5	24.6	24.5	24.6	20.7	20.7	20.8	20.2	20.3	20.3	70
75	49.6	49.5	49.7	43	43.1	43.3	36.6	36.4	36.3	30.6	30.3	30.4	24.1	24	24.1	20.4	20.3	20.4	20	20	20.1	75
80	46.9	47	47.1	41.1	41.1	41.4	35.3	35	34.9	29.5	29.3	29.3	23.5	23.4	23.5	19.9	19.9	19.9	19.6	19.6	19.6	80
85	44.4	44.4	44.6	39.2	39.2	39.5	34	33.7	33.6	28.5	28.3	28.3	22.8	22.8	22.8	19.4	19.3	19.4	19.1	19.1	19.1	85
90	42.1	42.1	42.3	37.3	37.4	37.6	32.7	32.4	32.3	27.5	27.3	27.3	22.2	22.1	22.2	18.8	18.7	18.8	18.6	18.5	18.5	90
95	39.8	40	40.1	35.5	35.6	35.8	31.4	31.2	31.1	26.6	26.3	26.3	21.5	21.4	21.5	18.2	18.1	18.2	18	17.9	18	95
100	37.7	37.8	38	33.8	33.9	34.1	30.1	30	29.9	25.6	25.4	25.4	20.9	20.7	20.8	17.6	17.5	17.6	17.4	17.4	17.4	100
105	35.9	35.9	36.1	32.1	32.2	32.5	28.9	28.8	28.8	24.7	24.5	24.5	20.2	20.1	20.1	17	16.9	17	16.9	16.8	16.8	105
110	34	34.2	34.3	30.6	30.6	30.9	27.6	27.6	27.6	23.7	23.6	23.6	19.5	19.4	19.5	16.5	16.4	16.4	16.3	16.2	16.3	110
115	32.2	32.4	32.5	29.1	29.2	29.4	26.3	26.4	26.5	22.9	22.7	22.7	18.9	18.8	18.8	15.9	15.9	15.9	15.8	15.7	15.7	115
120	30.6	30.7	30.8	27.7	27.8	28	25.1	25.2	25.3	22.1	21.9	21.9	18.2	18.1	18.2	15.4	15.3	15.4	15.3	15.2	15.2	120
125	29.1	29.2	29.3	26.3	26.5	26.6	24	24	24.2	21.3	21.2	21.2	17.6	17.5	17.6	14.8	14.8	14.8	14.7	14.7	14.7	125
130	27.7	27.7	27.9	25	25.2	25.3	22.9	23	23.1	20.5	20.4	20.4	17.1	17	17	14.3	14.3	14.3	14.3	14.2	14.2	130
135	25.8	26.1	26.3	23.8	23.9	24	21.8	22	22.1	19.7	19.6	19.7	16.5	16.4	16.5	13.8	13.8	13.8	13.8	13.7	13.8	135
140	23.9	24.2	24.4	22.7	22.8	22.9	20.8	20.9	21	19	18.9	19	15.9	15.9	15.9	13.4	13.4	13.4	13.3	13.3	13.3	140
145	22.9	22.9	23	21.5	21.7	21.8	19.8	19.9	20	18.2	18.2	18.3	15.4	15.4	15.4	12.9	12.9	12.9	12.9	12.8	12.9	145
150	21.9	21.9	22	20.5	20.6	20.7	18.9	19	19.1	17.5	17.5	17.6	15	14.9	14.9	12.5	12.5	12.5	12.4	12.4	12.5	150
155	20.6	20.8	18.2	19.2	19.5	19.6	17.9	18.1	18.2	16.7	16.8	16.9	14.5	14.4	14.5	12.1	12.1	12.1	12	12	12	155
160	19.2	19.3	14.7	17.8	18.1	18.1	17.1	17.2	17.3	16	16.1	16.2	14	14	14	11.7	11.7	11.7	11.7	11.6	11.7	160
165	17.8	18	12.2	17	17.1	17.1	16.2	16.3	16.4	15.3	15.4	15.4	13.6	13.5	13.6	11.3	11.3	11.3	11.3	11.3	11.3	165
170	16.6	16.7	10.2	16.3	16.3	16.4	15.4	15.6	15.6	14.6	14.6	14.7	13.1	13.1	13.1	10.9	10.9	11	10.9	10.9	10.9	170
175	15.5	15.6	8.6	15.7	15.7	13.9	14.5	14.7	14.7	13.8	13.9	14	12.7	12.7	12.7	10.6	10.6	10.6	10.6	10.6	10.6	175
180	13.1	13.2	7.1	14.8	14.9	11.8	13.5	13.5	13.6	13.2	13.3	13.3	12.3	12.3	12.3	10.2	10.2	10.2	10.2	10.2	10.2	180
185		9.3	9.1	13.8	13.9	10	12.9	12.9	13	12.6	12.7	12.7	11.9	11.9	11.9	9.8	9.8	9.9	9.7	9.8	9.8	185
190				12.8	12.9	8.6	12.4	12.5	12.5	11.4	11.4	11.5	11.5	11.5	11.6	9.5	9.5	9.5	9.2	9.3	9.3	190
195				10.7	10.7	7.2	11.9	12	11.4	10.9	11	11	11	11	11.1	9.1	9.1	9.2	8.8	8.8	8.9	195
200				7.7	7.7	5.1	11.4	11.4	9.9	9.4	9.7	9.8	10.5	10.6	10.6	8.8	8.8	8.9	8.3	8.4	8.4	200
205							9.8	9.9	8.5	7.5	7.9	7.8	10	10.1	10.1	8.5	8.5	8.5	7.9	7.9	8	205
210							8.8	8.8	7.3	5.7	6	6	9.5	9.6	9.6	8.1	8.2	8.2	7.5	7.5	7.5	210
215							5.7	5.8	4.2	4	4.3	4.2	8.8	8.9	8.9	7.8	7.9	7.9	7.1	7.1	7.1	215
220										2.4	2.6	2.3	8.1	8.2	8.2	7.5	7.6	7.6	6.7	6.7	6.7	220
225													7.4	7.5	7.5	7.2	7.2	7.3	6.3	6.3	6.3	225
230													6.9	6.9	6.9	6.9	7	7	5.9	5.9	6	230
235													6.4	6.4	6.4	6.5	6.5	6.5	5.6	5.6	5.6	235
240													4.6	4.8	4.3	5.9	6	6	5.2	5.2	5.2	240
245																5.3	5.3	5.3	4.9	4.9	4.8	245
250																4.4	4.6	4.3	4.4	4.4	4.4	250
255																	2.1		2.8	3	2.6	255

t\_240\_002\_56001\_00\_000

# Lifting capacities Forces de levage

**TNZK**

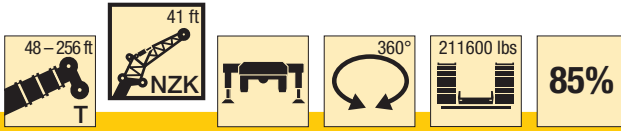

**Preliminary  
Préliminaire**

ft	48 ft			144 ft			160 ft			176 ft			192 ft			ft
	41 ft			41 ft			41 ft			41 ft			41 ft			
	0°	20°	40°	0°	20°	40°	0°	20°	40°	0°	20°	40°	0°	20°	40°	
12	52.4															12
13	52.1															13
14	51.7															14
15	51.2															15
16	50.7															16
17	50.1															17
18	49.5															18
19	48.9	39.2														19
20	48.3	39														20
22	47.1	37.2														22
24	45.8	35.3		52.7												24
26	44.3	33.6		52.8												26
28	42.9	32.1	23.1	52.8			47.4									28
30	41.4	30.8	22.8	52.6			47.4									30
32	40.1	29.5	22.1	52.4			47.4			41.7						32
34	38.8	28.5	21.6	52			47.3			41.6						34
36	37.6	27.4	21.1	51.7			47.1			41.6			35.6			36
38	36.3	26.4	20.6	51.2	38.4		46.7			41.5			35.7			38
40	34.9	25.6	20.2	50.7	37.5		46.3			41.3			35.7			40
45	31.2	23.6	19.2	49.3	35.2	23.1	45.4	36.1		40.7			35.5			45
50	28	22.1	18.4	47.8	33.3	22.3	44.5	34.1	22.5	40.1	34.5		35.2			50
55	25.4	20.8	17.8	46.3	31.6	21.7	43.5	32.3	21.9	39.5	32.9	22	34.8	31.8		55
60	23.4	19.6	17.4	44.6	30	21.1	42.6	30.8	21.3	38.8	31.3	21.4	34.4	31	21.5	60
65	21.6	18.7	17.1	42.9	28.7	20.6	41.4	29.5	20.8	38.2	29.9	20.9	34	30.1	20.9	65
70	20.1	18	17.1	41.1	27.5	20.1	40.1	28.3	20.3	37.5	28.7	20.5	33.6	28.8	20.5	70
75	18.8	17.6	16.3	39.5	26.4	19.6	38.8	27.2	19.9	36.7	27.5	20	33.1	27.7	20.1	75
80	17.8	17.5		38	25.4	19.2	37.6	26.2	19.5	35.8	26.6	19.7	32.7	26.7	19.7	80
85				36.5	24.5	18.9	36.4	25.2	19.1	34.9	25.7	19.3	32	25.8	19.4	85
90				34.8	23.6	18.6	35.2	24.4	18.8	34	24.8	19	31.4	25	19.1	90
95				33	22.9	18.3	34.1	23.6	18.5	33.1	24	18.7	30.7	24.3	18.8	95
100				31.3	22.2	18	32.9	22.9	18.2	32.3	23.3	18.4	29.9	23.5	18.5	100
105				29.6	21.5	17.8	31.4	22.3	18	31.5	22.7	18.1	29	22.9	18.2	105
110				28.2	20.9	17.6	30	21.7	17.8	30.5	22.1	17.9	27.8	22.3	18	110
115				26.9	20.4	17.4	28.6	21	17.6	29.4	21.5	17.7	26.5	21.7	17.8	115
120				25.7	19.9	17.3	27.3	20.6	17.4	28.2	21	17.5	25.4	21.1	17.6	120
125				24.6	19.4	17.2	26.3	20.1	17.3	27	20.5	17.4	24.3	20.7	17.4	125
130				23.7	19	17.1	25.2	19.6	17.1	25.9	20.1	17.2	23.2	20.3	17.3	130
135				22.8	18.7	17.1	24.2	19.2	17.1	24.7	19.7	17.2	22.2	19.9	17.2	135
140				21.9	18.3	17.1	23.3	18.9	17	23.6	19.3	17.1	21.2	19.5	17.1	140
145				21.1	18	15.7	22.6	18.6	17	22.6	18.9	17	20.2	19.1	17.1	145
150				20.4	17.8	10.1	21.8	18.2	17	21.5	18.6	17	19.3	18.7	17	150
155				19.7	17.6	7.2	21	18	16.5	20.4	18.4	17	18.4	18.3	17	155
160				19.1	17.5	5.4	20.4	17.8	12.4	19	18.1	17	17.5	17.8	16.8	160
165				18.6	17.5		19.4	17.6	8.7	17.7	17.8	17	16.7	17.1	16.6	165
170				17.2	16		18.1	17.5	6.6	17	17.1	15.1	16	16.4	16.4	170
175				10.2	6.9		17	17.4	5.1	16.3	16.5	10.5	15	15.6	15.9	175
180							15.9	16.3		15.5	15.8	7.8	14	14.7	15	180
185							13.3	15.2		14.5	15	6.1	13.1	13.6	12.2	185
190							7.7	7.5		13.6	14	4.9	12.6	12.7	9.1	190
195										12.7	13		12.1	12.2	7.2	195
200										10.4	12.1		11.6	11.7	5.8	200
205										6.1	7.8		11	11.3		205
210													10.3	10.6		210
215													8.3	9.8		215
220													7.1	7.2		220

t\_240\_002\_56101\_00\_000



# Lifting capacities Forces de levage

**TNZK**

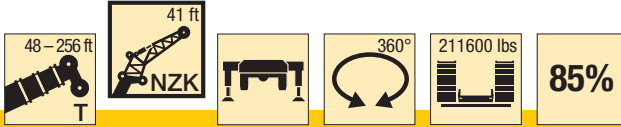

**Preliminary  
Préliminaire**

ft	208 ft			224 ft			240 ft			253 ft			256 ft			ft
	41 ft			41 ft			41 ft			41 ft			41 ft			
	0°	20°	40°	0°	20°	40°	0°	20°	40°	0°	20°	40°	0°	20°	40°	
45	30			23.3												45
50	30.1			23.5			19.4									50
55	29.9			23.6			19.4			16.4			15.9			55
60	29.7	28.3		23.8			19.4			16.4			15.9			60
65	29.5	27.8	20.9	23.9	23.9		19.3			16.4			16			65
70	29.3	27.4	22.6	23.8	23.7		19.2	19.2		16.3			15.9			70
75	28.9	26.9	22	23.6	23.3	22.5	19.1	18.8		16.1	16		15.8	15.7		75
80	28.5	26.4	21.5	23.2	22.8	22.1	18.9	18.4	17.8	15.9	15.8		15.6	15.5		80
85	28.1	25.6	21.1	22.6	22.3	21.7	18.7	17.9	17.4	15.7	15.5	15.1	15.4	15.2	15	85
90	27.4	24.8	20.8	22.1	21.7	21.2	18.2	17.5	16.9	15.5	15.1	14.7	15.2	15	14.6	90
95	26.7	24.1	20.5	21.5	21.1	20.7	17.9	17	16.5	15.1	14.8	14.4	14.9	14.6	14.2	95
100	25.8	23.4	20.2	20.8	20.4	20.3	17.4	16.6	16	14.7	14.4	14	14.5	14.3	13.9	100
105	24.9	22.8	19.9	20.2	19.8	19.7	17	16.1	15.6	14.3	14.1	13.7	14.1	13.9	13.6	105
110	24	22.2	19.4	19.5	19.1	19.1	16.5	15.7	15.2	13.9	13.7	13.4	13.8	13.6	13.3	110
115	23.2	21.7	18.8	18.9	18.5	18.5	16.1	15.3	14.9	13.5	13.3	13	13.4	13.2	12.9	115
120	22.4	21.1	18.2	18.2	17.9	17.9	15.6	14.9	14.5	13.1	12.9	12.7	12.9	12.8	12.6	120
125	21.5	20.7	17.6	17.6	17.3	17.3	15.1	14.6	14.2	12.6	12.5	12.4	12.5	12.4	12.3	125
130	20.7	20.1	17.3	17	16.8	16.7	14.6	14.2	13.9	12.2	12.1	12.1	12.1	12	12.1	130
135	19.9	19.6	17.2	16.4	16.2	16.2	14.1	13.8	13.6	11.8	11.7	11.8	11.7	11.6	11.7	135
140	19.1	19	17.1	15.9	15.7	15.7	13.7	13.4	13.2	11.4	11.3	11.4	11.3	11.2	11.4	140
145	18.3	18.3	17.1	15.4	15.2	15.2	13.2	13	12.9	11	10.9	11	10.9	10.9	11	145
150	17.5	17.7	17	14.9	14.7	14.7	12.8	12.7	12.6	10.6	10.6	10.7	10.6	10.5	10.6	150
155	16.7	17.1	16.8	14.4	14.3	14.3	12.4	12.3	12.3	10.3	10.2	10.3	10.2	10.2	10.3	155
160	16	16.4	16.3	13.9	13.8	13.8	12	11.9	12	9.9	9.9	10	9.9	9.8	9.9	160
165	15.3	15.6	15.7	13.5	13.3	13.4	11.6	11.6	11.6	9.6	9.5	9.6	9.5	9.5	9.6	165
170	14.6	14.9	15.2	13	12.9	13	11.2	11.2	11.3	9.2	9.2	9.3	9.2	9.2	9.3	170
175	13.9	14.2	14.5	12.5	12.5	12.6	10.9	10.8	10.9	8.9	8.9	9	8.9	8.9	9	175
180	13.2	13.6	13.9	12.1	12.1	12.2	10.5	10.5	10.6	8.6	8.6	8.7	8.6	8.6	8.7	180
185	12.6	13	13.2	11.6	11.7	11.8	10.2	10.2	10.3	8.3	8.3	8.4	8.3	8.3	8.4	185
190	12	12.3	12.6	11.1	11.3	11.5	9.8	9.9	9.9	8	8	8.1	8	8	8.1	190
195	11.2	11.7	11.9	10.7	10.9	11.1	9.5	9.5	9.6	7.8	7.8	7.9	7.7	7.8	7.9	195
200	10.3	11	10.7	10.2	10.4	10.7	9.2	9.2	9.3	7.5	7.5	7.6	7.4	7.5	7.6	200
205	9.8	10.1	8.3	9.7	10	10.2	8.9	8.9	9.1	7.3	7.3	7.4	7.1	7.3	7.4	205
210	9.5	9.5	6.7	9.2	9.5	9.7	8.6	8.7	8.8	7.1	7	7.1	6.8	7.1	7.1	210
215	9.1	9.2	5.5	8.7	9	9.2	8.3	8.4	8.5	6.8	6.8	6.9	6.5	6.8	6.8	215
220	8.7	8.8		7.9	8.4	7.6	7.9	8.1	8.2	6.6	6.6	6.7	6.2	6.4	6.5	220
225	8.4	8.5		7.6	7.7	6.3	7.6	7.8	7.9	6.4	6.4	6.5	5.9	6.1	6.2	225
230	7	8.2		7.4	7.4	5.3	7.2	7.5	7.6	6.2	6.2	6.3	5.5	5.7	5.9	230
235	5.6	6.6		7.1	7.2		6.8	7.1	7	6	6	6.1	5.1	5.4	5.5	235
240				6.9	6.9		6.3	6.6	6	5.8	5.8	5.9	4.8	5	5.1	240
245				6.1	6.8		5.8	6.1	5.1	5.5	5.6	5.7	4.4	4.7	4.7	245
250				3.5	4.8		5.1	5.5		5.2	5.4	5.5	4.1	4.3	4.4	250
255							4.6	4.9		4.6	5	5.1	3.8	4	4	255
260							3.2	4.3		4	4.4		3.5	3.7	3.7	260
265										3.4	3.8		3.2	3.4		265
270										2.8	3.2		2.7	3		270
275														2.4		275

t\_240\_002\_56101\_00\_000

# Lifting capacities Forces de levage

**TNZK**



**Preliminary  
Préliminaire**

ft	48 ft			144 ft			160 ft			176 ft			192 ft			ft
	69 ft			69 ft			69 ft			69 ft			69 ft			
	0°	20°	40°	0°	20°	40°	0°	20°	40°	0°	20°	40°	0°	20°	40°	
12	20.8															12
13	20.8															13
14	20.9															14
15	21															15
16	21															16
17	21															17
18	21															18
19	21															19
20	21															20
22	21															22
24	20.9															24
26	20.7															26
28	20.5			20.8												28
30	20.3			20.9			19.9									30
32	20			21			19.9									32
34	19.7	17.8		21			19.9			18.7						34
36	19.4	17.5		21			19.9			18.7						36
38	19.1	17.2		21			19.9			18.8			17.4			38
40	18.7	16.9		21			19.9			18.8			17.4			40
45	17.9	16.1		21			19.9			18.8			17.5			45
50	17.1	15.4		20.8			19.9			18.8			17.5			50
55	16.3	14.7	13.2	20.5	17.5		19.8	17.2		18.8			17.5			55
60	15.5	14.1	12.8	20.3	17		19.6	16.8		18.7	16.3		17.5			60
65	14.8	13.6	12.4	19.9	16.7		19.3	16.4		18.5	16		17.3	15.2		65
70	14.2	13.1	12	19.5	16.2	13.4	19	16		18.2	15.6		17.1	15		70
75	13.6	12.6	11.8	19	15.8	13.2	18.6	15.6	13.1	17.9	15.3		16.8	14.7		75
80	13.1	12.3	11.6	18.6	15.4	13	18.2	15.3	12.9	17.6	15	12.7	16.6	14.4		80
85	12.6	12	11.4	18.1	15.1	12.8	17.8	15	12.7	17.2	14.7	12.5	16.3	14.2	12.2	85
90	12.1	11.7	11.4	17.7	14.7	12.6	17.4	14.6	12.5	16.9	14.4	12.3	16	13.9	12.1	90
95	11.6	11.5	11.4	17.2	14.4	12.4	17	14.3	12.3	16.5	14.1	12.2	15.7	13.7	11.9	95
100	11.1	11.4	11.4	16.7	14.1	12.2	16.6	14.1	12.2	16.2	13.9	12	15.4	13.4	11.8	100
105	10.6	11.3	4.5	16.3	13.8	12.1	16.2	13.8	12	15.9	13.6	11.9	15.1	13.2	11.7	105
110	9.8			15.9	13.5	11.9	15.8	13.5	11.9	15.5	13.4	11.7	14.9	13	11.5	110
115				15.5	13.3	11.8	15.5	13.3	11.8	15.2	13.1	11.6	14.6	12.8	11.4	115
120				15.1	13.1	11.7	15.1	13	11.6	14.9	12.9	11.5	14.4	12.6	11.3	120
125				14.7	12.8	11.6	14.8	12.8	11.5	14.6	12.7	11.4	14.1	12.4	11.2	125
130				14.4	12.6	11.5	14.4	12.6	11.4	14.3	12.5	11.4	13.9	12.3	11.1	130
135				14.1	12.4	11.5	14.1	12.4	11.4	14	12.3	11.3	13.6	12.1	11.1	135
140				13.7	12.2	11.4	13.8	12.3	11.3	13.8	12.2	11.2	13.4	11.9	11	140
145				13.4	12.1	11.4	13.6	12.1	11.3	13.5	12	11.2	13.2	11.8	11	145
150				13.1	11.9	11.4	13.3	11.9	11.2	13.3	11.9	11.1	13	11.7	10.9	150
155				12.9	11.8	11.4	13	11.8	11.2	13	11.7	11.1	12.8	11.5	10.9	155
160				12.6	11.7	11.4	12.8	11.7	11.2	12.8	11.6	11.1	12.6	11.4	10.8	160
165				12.3	11.6	11.4	12.5	11.6	11.2	12.5	11.5	11.1	12.4	11.3	10.8	165
170				12	11.5	11.4	12.3	11.5	11.2	12.3	11.4	11.1	12.2	11.2	10.8	170
175				11.8	11.5	11.4	12.1	11.4	11.2	12.1	11.3	11.1	12	11.1	10.8	175
180				11.5	11.4	8.6	11.8	11.3	11.2	12	11.2	11.1	11.8	11.1	10.8	180
185				11.2	11.3	6.2	11.6	11.3	11.2	11.8	11.2	11.1	11.7	11	10.8	185
190				10.9	11.3		11.4	11.3	10.3	11.6	11.1	11.1	11.5	10.9	10.8	190
195				10.6	11.3		11.2	11.2	7.6	11.4	11.1	11.1	11.2	10.9	10.8	195
200				10.2	10.7		11	11.2	5.8	11.3	11.1	11.1	11	10.9	10.8	200
205							10.8	11.2		11.1	11	9.1	10.7	10.9	10.8	205
210							10.5	11.2		10.9	11	7	10.1	10.6	10.8	210
215							7.7	10.6		10.7	10.9	5.4	9.4	10.2	10.3	215
220										10.1	10.7		9	9.4	8.2	220
225										8.8	9.9		8.7	8.8	6.4	225
230										6	8.1		8.3	8.5	5.2	230
235											3		8	8.2		235
240													7	7.9		240
245													5.2	6.5		245
250														5.2		250

t\_240\_002\_56301\_00\_000

# Lifting capacities Forces de levage

**TNZK**

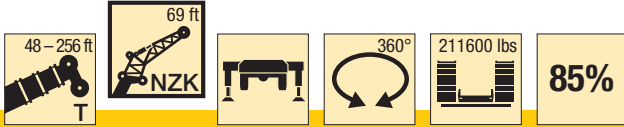

**Preliminary  
Préliminaire**

ft	208 ft			224 ft			240 ft			253 ft			256 ft			ft
	69 ft			69 ft			69 ft			69 ft			69 ft			
	0°	20°	40°	0°	20°	40°	0°	20°	40°	0°	20°	40°	0°	20°	40°	
45	15.8															45
50	15.9			14												50
55	15.9			14.1			12.2									55
60	15.8			14.1			12.2			10.6			10.4			60
65	15.7			14			12.2			10.6			10.4			65
70	15.6	14.1		14			12.2			10.7			10.4			70
75	15.5	13.9		13.8			12.1			10.7			10.5			75
80	15.2	13.6		13.7	12.6		12.1			10.7			10.4			80
85	15	13.4		13.6	12.5		12	11.3		10.6			10.4			85
90	14.8	13.2	11.7	13.4	12.3		11.9	11.2		10.6	10.2		10.4	10		90
95	14.6	13	11.5	13.2	12.1	11.1	11.8	11.1		10.5	10.1		10.3	10		95
100	14.4	12.8	11.4	13.1	12	11	11.7	11		10.4	10.1		10.3	9.9		100
105	14.2	12.6	11.3	13	11.9	10.9	11.6	10.9	10.3	10.4	10		10.2	9.8		105
110	14	12.4	11.2	12.8	11.7	10.8	11.5	10.8	10.3	10.3	9.9	9.6	10.1	9.8	9.5	110
115	13.8	12.3	11.1	12.7	11.6	10.7	11.4	10.7	10.2	10.2	9.8	9.5	10	9.7	9.4	115
120	13.6	12.1	11	12.5	11.5	10.6	11.2	10.6	10.1	10.1	9.6	9.4	10	9.5	9.3	120
125	13.4	12	11	12.4	11.4	10.6	11.1	10.5	10.1	10	9.4	9.2	9.9	9.4	9.1	125
130	13.2	11.8	10.9	12.2	11.2	10.5	10.9	10.4	10	9.8	9.2	8.9	9.7	9.1	8.9	130
135	13	11.7	10.8	12.1	11.1	10.5	10.8	10.2	9.9	9.5	9	8.7	9.5	8.9	8.7	135
140	12.8	11.5	10.8	11.9	11	10.5	10.6	10	9.7	9.2	8.7	8.5	9.2	8.7	8.5	140
145	12.6	11.4	10.7	11.8	10.9	10.4	10.4	9.8	9.5	9	8.5	8.3	8.9	8.5	8.3	145
150	12.4	11.3	10.7	11.6	10.8	10.4	10.2	9.6	9.3	8.7	8.3	8.1	8.7	8.3	8.1	150
155	12.2	11.2	10.7	11.5	10.7	10.4	10	9.3	9.1	8.5	8.1	7.9	8.4	8.1	7.9	155
160	12.1	11.1	10.6	11.3	10.6	10.3	9.7	9.1	8.9	8.2	7.9	7.8	8.2	7.9	7.8	160
165	11.9	11	10.6	11.1	10.5	10.3	9.5	8.9	8.8	8	7.7	7.6	7.9	7.7	7.6	165
170	11.8	10.9	10.6	10.8	10.4	10.3	9.2	8.7	8.6	7.7	7.6	7.5	7.7	7.5	7.5	170
175	11.6	10.9	10.6	10.5	10.2	10.3	8.9	8.5	8.4	7.4	7.4	7.3	7.4	7.4	7.3	175
180	11.4	10.8	10.6	10.2	10	10.2	8.7	8.3	8.2	7.2	7.2	7.2	7.2	7.2	7.2	180
185	11.1	10.7	10.6	9.9	9.8	10	8.5	8.1	8.1	7	7	7	6.9	7	7	185
190	10.8	10.7	10.6	9.6	9.6	9.8	8.2	8	7.9	6.8	6.8	6.9	6.7	6.8	6.9	190
195	10.6	10.6	10.6	9.3	9.3	9.6	7.9	7.8	7.8	6.6	6.7	6.8	6.5	6.6	6.7	195
200	10.3	10.5	10.6	9.1	9.1	9.3	7.7	7.6	7.6	6.4	6.5	6.6	6.3	6.4	6.6	200
205	9.9	10.2	10.5	8.8	8.8	9	7.5	7.5	7.5	6.2	6.3	6.4	6.2	6.2	6.4	205
210	9.5	9.8	10.2	8.5	8.5	8.7	7.3	7.3	7.4	6	6.1	6.2	6	6.1	6.2	210
215	9.1	9.5	9.9	8.2	8.3	8.5	7.1	7.1	7.2	5.8	5.9	6	5.8	5.9	6	215
220	8.6	9.1	9.4	7.9	8	8.3	6.9	6.9	7.1	5.6	5.7	5.9	5.6	5.7	5.8	220
225	7.9	8.7	8.9	7.6	7.7	8	6.7	6.8	6.9	5.5	5.5	5.7	5.3	5.5	5.7	225
230	7.3	8.1	8.4	7.3	7.5	7.7	6.5	6.6	6.8	5.3	5.4	5.5	5	5.3	5.5	230
235	7	7.5	7.5	6.9	7.2	7.4	6.3	6.4	6.6	5.1	5.2	5.4	4.7	5.2	5.3	235
240	6.8	7	6.1	6.5	6.9	7.1	6.1	6.3	6.4	5	5	5.2	4.5	5	5.1	240
245	6.6	6.7	5	6.1	6.6	6.8	5.9	6.1	6.2	4.8	4.9	5	4.2	4.7	4.8	245
250	6.4	6.5		5.7	6.2	6.3	5.7	5.9	6.1	4.6	4.7	4.9	3.9	4.4	4.5	250
255	5.7	6.2		5.5	5.7	5.7	5.4	5.7	5.9	4.4	4.6	4.7	3.6	4.1	4.2	255
260	4.9	5.4		5.4	5.4		4.9	5.4	5.6	4.2	4.4	4.5	3.3	3.7	3.9	260
265		3.4		5.2	5.3		4.4	5.1	5.3	4	4.2	4.4	3	3.4	3.5	265
270				4.7	5.1		3.9	4.5	4.6	3.7	4	4.1	2.7	3.1	3.2	270
275				2.8	4.5		3.3	3.9		3.3	3.8	3.9	2.4	2.8	2.9	275
280							2.9	3.4		2.5	3.4	3.5		2.5	2.5	280
285								2.8			2.9	2.9				285

t\_240\_002\_56301\_00\_000

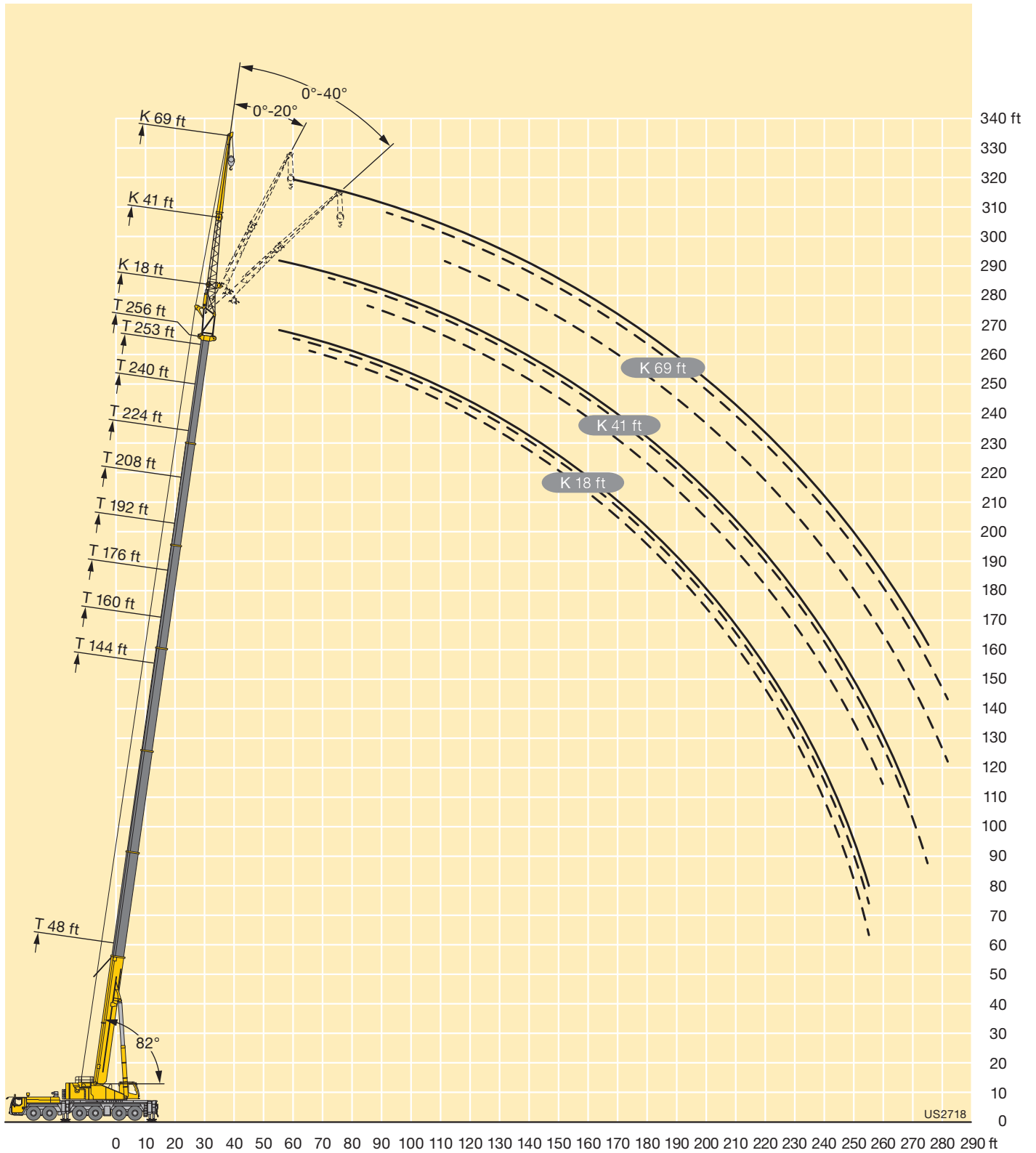

# Lifting capacities Forces de levage

**TNZK**

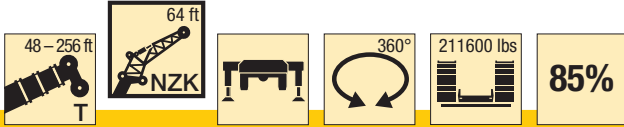

**Preliminary  
Préliminaire**

ft	48 ft			144 ft			160 ft			176 ft			192 ft			ft
	64 ft			64 ft			64 ft			64 ft			64 ft			
	0°	20°	40°	0°	20°	40°	0°	20°	40°	0°	20°	40°	0°	20°	40°	
12	31.4															12
13	31.4															13
14	31.4															14
15	31.4															15
16	31.2															16
17	31															17
18	30.7															18
19	30.5															19
20	30.2															20
22	29.6															22
24	29															24
26	28.4															26
28	27.7			31.4												28
30	27.1			31.4			27									30
32	26.4	22.9		31.4			27									32
34	25.8	22.3		31.3			27			24.9						34
36	25.2	21.6		31.1			27			24.9						36
38	24.6	21		30.9			27			24.9			22.1			38
40	24	20.4		30.6			27			25			22.1			40
45	22.6	19.1		29.8			27			25			22.1			45
50	21.2	17.9	15.1	29	22.7		26.9			25			22.2			50
55	19.7	16.9	14.3	28.1	21.9		26.7	22.3		24.7			22.1			55
60	18.2	16	13.7	27.3	21		26.1	21.7		24.3	20.9		21.9			60
65	16.9	15.2	13.1	26.4	20.3	15.4	25.5	21.2		23.9	20.4		21.6	19.3		65
70	15.6	14.5	12.6	25.6	19.6	15	25	20.6	15.9	23.4	19.9		21.3	18.9		70
75	14.5	13.8	12.2	24.8	18.9	14.7	24.3	20.1	15.7	23	19.5	15.5	21	18.6		75
80	13.6	13.2	11.9	24	18.3	14.3	23.7	19.6	15.4	22.5	19.1	15.2	20.7	18.2	14.9	80
85	12.7	12.7	11.7	23.2	17.8	14	23.1	19.1	15.1	22.1	18.7	14.9	20.4	17.9	14.6	85
90	11.9	12.2	11.6	22.4	17.2	13.7	22.5	18.6	14.8	21.6	18.2	14.7	20	17.5	14.4	90
95	11.3	11.8	11.6	21.7	16.7	13.4	21.9	18.1	14.5	21.1	17.8	14.4	19.7	17.2	14.2	95
100	10.7	11.6	5.1	20.9	16.2	13.1	21.4	17.6	14.3	20.7	17.4	14.2	19.4	16.8	14	100
105	10.3			20.1	15.8	12.9	20.8	17.1	14.1	20.2	17	14	19.1	16.5	13.8	105
110				19.3	15.4	12.7	20.3	16.7	13.9	19.8	16.6	13.8	18.8	16.2	13.6	110
115				18.5	15	12.5	19.8	16.3	13.7	19.4	16.2	13.6	18.4	15.9	13.4	115
120				17.7	14.7	12.3	19.3	15.9	13.5	18.9	15.9	13.4	18.1	15.5	13.3	120
125				17	14.3	12.1	18.8	15.6	13.3	18.5	15.6	13.3	17.8	15.2	13.1	125
130				16.3	14	12	18.3	15.3	13.2	18.1	15.2	13.1	17.5	15	13	130
135				15.6	13.7	11.9	17.8	14.9	13	17.7	15	13	17.2	14.7	12.8	135
140				15	13.4	11.8	17.3	14.6	12.9	17.3	14.7	12.9	16.8	14.4	12.8	140
145				14.5	13.1	11.7	16.9	14.3	12.8	16.9	14.4	12.8	16.5	14.2	12.7	145
150				14	12.9	11.7	16.4	14	12.8	16.5	14.1	12.7	16.2	14	12.6	150
155				13.5	12.6	11.6	15.9	13.8	12.7	16.1	13.9	12.7	15.9	13.7	12.5	155
160				13	12.3	11.6	15.4	13.5	12.6	15.7	13.6	12.6	15.5	13.5	12.5	160
165				12.5	12.1	11.6	14.9	13.3	12.6	15.3	13.3	12.6	15.1	13.3	12.4	165
170				12.1	12	11.6	14.4	13	12.6	14.9	13.1	12.5	14.7	13.1	12.4	170
175				11.8	11.8	8.7	13.9	12.8	12.6	14.5	12.9	12.5	14.2	12.9	12.3	175
180				11.4	11.7	6.3	13.5	12.6	12.6	14.1	12.7	12.5	13.8	12.7	12.3	180
185				11.1	11.6		13.1	12.5	10.6	13.7	12.5	12.4	13.3	12.5	12.3	185
190				10.8	11.6		12.7	12.3	7.6	13.3	12.4	12.4	12.7	12.3	12.3	190
195				10.5	11.1		12.3	12.3	5.8	12.8	12.3	11.8	12.2	12.1	12.3	195
200							12	12.2		12.4	12.2	9.1	11.3	11.8	12	200
205							11.5	12.2		11.9	11.9	7	10.5	11.4	11.6	205
210							8.2	10.9		11.2	11.6	5.5	9.7	10.6	10.6	210
215								3.8		10.5	11		9.4	9.7	8.2	215
220										9.3	10.2		9	9.2	6.5	220
225										6.3	8.4		8.7	8.8	5.2	225
230											3.4		8.3	8.5		230
235													7.4	8.1		235
240													5.4	6.8		240
245													4.1	5.4		245

t\_240\_002\_56201\_00\_000

# Lifting capacities Forces de levage

**TNZK**

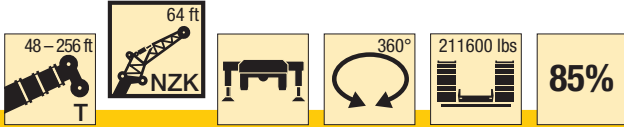

**Preliminary  
Préliminaire**

ft	208 ft			224 ft			240 ft			253 ft			256 ft			ft
	64 ft			64 ft			64 ft			64 ft			64 ft			
	0°	20°	40°	0°	20°	40°	0°	20°	40°	0°	20°	40°	0°	20°	40°	
45	19.2															45
50	19.2			16.4												50
55	19.3			16.4			13.8									55
60	19.2			16.4			13.9			11.9			11.6			60
65	19.1			16.4			13.9			11.9			11.6			65
70	18.9	17.5		16.4			13.9			12			11.7			70
75	18.7	17.2		16.3	15.5		13.9			12			11.7			75
80	18.5	17		16.2	15.4		13.8			11.8			11.6			80
85	18.3	16.7	14.2	16	15.2		13.7	13.2		11.7			11.5			85
90	18.1	16.5	14	15.9	15.1		13.6	13.2		11.6	11.2		11.4	10.9		90
95	17.9	16.2	13.8	15.7	14.9	13.1	13.5	13.1		11.5	11.2		11.3	10.9		95
100	17.7	15.9	13.6	15.6	14.8	13	13.3	12.9	12.1	11.4	11.1		11.2	10.8		100
105	17.4	15.7	13.4	15.4	14.6	12.9	13.2	12.6	12	11.2	10.9	10.5	11.1	10.7	10.4	105
110	17.2	15.4	13.2	15.2	14.4	12.8	13	12.2	11.7	11.1	10.6	10.2	10.9	10.5	10.2	110
115	17	15.2	13.1	15	14.2	12.6	12.8	11.9	11.4	10.9	10.3	10	10.7	10.2	9.9	115
120	16.8	14.9	13	14.8	14	12.5	12.5	11.6	11.2	10.7	10.1	9.7	10.6	10	9.7	120
125	16.6	14.7	12.8	14.6	13.8	12.4	12.2	11.3	10.9	10.5	9.8	9.5	10.4	9.7	9.4	125
130	16.3	14.4	12.7	14.3	13.6	12.3	11.8	11	10.6	10.2	9.6	9.3	10.1	9.5	9.2	130
135	16.1	14.2	12.6	14	13.4	12.2	11.5	10.7	10.4	9.9	9.3	9	9.8	9.2	9	135
140	15.9	14	12.5	13.7	13.2	12.2	11.2	10.5	10.1	9.6	9.1	8.8	9.5	9	8.8	140
145	15.6	13.8	12.4	13.2	12.9	12.1	10.9	10.2	9.9	9.3	8.9	8.6	9.2	8.8	8.6	145
150	15.2	13.6	12.4	12.8	12.6	12	10.6	9.9	9.7	9	8.6	8.4	8.9	8.6	8.4	150
155	14.8	13.4	12.3	12.4	12.2	11.9	10.4	9.7	9.5	8.7	8.4	8.2	8.6	8.4	8.2	155
160	14.3	13.2	12.2	12	11.8	11.7	10.1	9.5	9.2	8.4	8.2	8	8.3	8.2	8	160
165	13.9	12.9	12.2	11.6	11.5	11.5	9.8	9.2	9	8.1	8	7.8	8.1	7.9	7.8	165
170	13.4	12.7	12.1	11.2	11.1	11.2	9.5	9	8.9	7.8	7.8	7.7	7.8	7.7	7.7	170
175	13	12.5	12.1	10.9	10.8	10.9	9.2	8.8	8.7	7.5	7.5	7.5	7.5	7.5	7.5	175
180	12.5	12.2	12	10.5	10.5	10.6	9	8.6	8.5	7.2	7.3	7.3	7.2	7.3	7.3	180
185	12	11.9	11.9	10.1	10.1	10.3	8.7	8.4	8.3	7	7.1	7.2	7	7.1	7.1	185
190	11.4	11.6	11.7	9.8	9.8	10	8.4	8.2	8.2	6.8	6.9	7	6.8	6.9	7	190
195	10.9	11.3	11.6	9.5	9.5	9.7	8.1	8	8	6.6	6.7	6.8	6.6	6.7	6.8	195
200	10.4	10.9	11.1	9.2	9.2	9.4	7.8	7.9	7.9	6.4	6.5	6.6	6.4	6.5	6.6	200
205	10	10.4	10.7	8.9	8.9	9.1	7.6	7.7	7.7	6.2	6.3	6.4	6.2	6.3	6.4	205
210	9.5	9.9	10.2	8.6	8.6	8.8	7.4	7.4	7.5	6	6.1	6.2	6	6.1	6.2	210
215	8.9	9.5	9.7	8.3	8.3	8.6	7.2	7.2	7.3	5.8	5.9	6	5.8	5.9	6	215
220	8.3	9	9.2	7.9	8	8.3	7	7	7.1	5.7	5.7	5.9	5.5	5.7	5.9	220
225	7.6	8.4	8.7	7.6	7.7	8	6.7	6.8	6.9	5.5	5.5	5.7	5.2	5.5	5.7	225
230	7.3	7.7	7.5	7.2	7.4	7.7	6.5	6.6	6.8	5.3	5.4	5.5	4.9	5.3	5.5	230
235	7	7.1	6.1	6.8	7.1	7.3	6.3	6.5	6.6	5.2	5.2	5.3	4.6	5.1	5.3	235
240	6.8	6.9	5	6.3	6.8	7	6.1	6.3	6.4	5	5	5.2	4.3	4.8	5	240
245	6.6	6.6		5.9	6.3	6.5	5.8	6.1	6.2	4.8	4.9	5	4.1	4.5	4.7	245
250	6	6.4		5.7	5.8	5.8	5.6	5.9	6.1	4.6	4.7	4.9	3.8	4.2	4.4	250
255	5	5.6		5.5	5.6		5.1	5.6	5.8	4.4	4.6	4.7	3.5	3.8	4	255
260		3.6		5.4	5.4		4.6	5.3	5.4	4.1	4.4	4.5	3.2	3.5	3.7	260
265				4.9	5.3		4	4.7	4.8	3.8	4.1	4.3	2.9	3.2	3.3	265
270				3	4.6		3.5	4.1		3.3	3.9	4	2.6	2.9	3	270
275							3	3.5			3.5	3.6		2.6	2.6	275
280								2.9			2.5	2.6				280

t\_240\_002\_56201\_00\_000

# Lifting capacities Forces de levage

**TNZK**



**Preliminary  
Préliminaire**

ft	48 ft			144 ft			160 ft			176 ft			192 ft			ft
	87 ft			87 ft			87 ft			87 ft			87 ft			
	0°	20°	40°	0°	20°	40°	0°	20°	40°	0°	20°	40°	0°	20°	40°	
14	19.4															14
15	19.4															15
16	19.4															16
17	19.4															17
18	19.4															18
19	19.5															19
20	19.4															20
22	19.3															22
24	19.1															24
26	18.9															26
28	18.5															28
30	18.2															30
32	17.8			19.4												32
34	17.5			19.4			18									34
36	17.1			19.5			18.1									36
38	16.8			19.5			18.1			16.5						38
40	16.4			19.4			18.1			16.6						40
45	15.6	13.5		19.2			18.1			16.6			14.9			45
50	14.8	12.7		18.8			17.8			16.5			15			50
55	14	11.9		18.3			17.5			16.4			14.9			55
60	13.1	11.2		17.8			17.1			16.1			14.7			60
65	12.4	10.6	8.9	17.2	13.4		16.6	13.1		15.7			14.5			65
70	11.6	10	8.5	16.7	12.9		16.2	12.7		15.4	12.4		14.3			70
75	10.9	9.5	8.1	16.2	12.4		15.8	12.3		15	12		14	11.6		75
80	10.3	9	7.8	15.7	12		15.3	11.9		14.7	11.7		13.7	11.3		80
85	9.7	8.5	7.5	15.2	11.5	8.7	14.9	11.5		14.3	11.3		13.4	11		85
90	9.1	8.2	7.3	14.8	11.1	8.5	14.5	11.1	8.5	14	11	8.4	13.2	10.7		90
95	8.6	7.8	7.1	14.3	10.8	8.3	14.1	10.8	8.3	13.6	10.7	8.2	12.9	10.4	8	95
100	8.2	7.5	6.9	13.8	10.5	8.1	13.7	10.5	8.1	13.3	10.4	8	12.6	10.1	7.9	100
105	7.8	7.3	6.8	13.3	10.1	8	13.3	10.2	7.9	13	10.1	7.9	12.3	9.8	7.8	105
110	7.4	7	6.8	12.9	9.8	7.8	12.9	9.9	7.8	12.6	9.8	7.7	12.1	9.6	7.6	110
115	7	6.9	6.8	12.4	9.5	7.6	12.5	9.6	7.6	12.3	9.6	7.6	11.8	9.3	7.5	115
120	6.7	6.8	6.8	12	9.3	7.5	12.1	9.3	7.5	12	9.3	7.5	11.5	9.1	7.4	120
125	6.5	6.8		11.5	9	7.4	11.7	9.1	7.4	11.6	9.1	7.4	11.3	8.9	7.3	125
130				11.1	8.8	7.3	11.4	8.8	7.3	11.3	8.8	7.2	11	8.7	7.2	130
135				10.7	8.5	7.2	11	8.6	7.2	11	8.6	7.1	10.7	8.5	7.1	135
140				10.3	8.3	7.1	10.6	8.4	7.1	10.7	8.4	7	10.4	8.3	7	140
145				10	8.1	7	10.2	8.2	7	10.4	8.2	7	10.2	8.2	6.9	145
150				9.6	7.9	6.9	9.9	8	6.9	10.1	8.1	6.9	9.9	8	6.8	150
155				9.3	7.8	6.9	9.6	7.9	6.9	9.8	7.9	6.8	9.7	7.8	6.8	155
160				9	7.6	6.8	9.3	7.7	6.8	9.5	7.7	6.8	9.4	7.7	6.7	160
165				8.8	7.4	6.8	9	7.6	6.8	9.2	7.6	6.7	9.2	7.5	6.7	165
170				8.5	7.3	6.8	8.8	7.4	6.8	9	7.4	6.7	8.9	7.4	6.6	170
175				8.2	7.2	6.8	8.5	7.3	6.7	8.7	7.3	6.7	8.7	7.3	6.6	175
180				7.9	7.1	6.8	8.3	7.2	6.7	8.5	7.2	6.6	8.5	7.2	6.6	180
185				7.7	7	6.8	8.1	7.1	6.7	8.2	7.1	6.6	8.3	7.1	6.6	185
190				7.5	6.9	6.8	7.9	7	6.7	8	7	6.6	8.1	7	6.5	190
195				7.2	6.9	6.8	7.6	6.9	6.7	7.9	6.9	6.6	7.9	6.9	6.5	195
200				7	6.8	6.8	7.4	6.9	6.7	7.7	6.9	6.6	7.7	6.8	6.5	200
205				6.9	6.8	5.4	7.3	6.8	6.7	7.5	6.8	6.6	7.6	6.8	6.5	205
210				6.7	6.8		7.1	6.8	6.7	7.4	6.7	6.6	7.5	6.7	6.5	210
215				6.6	6.8		6.9	6.8	6.5	7.2	6.7	6.6	7.3	6.7	6.5	215
220				6.1	6.8		6.8	6.8	5.1	7.1	6.7	6.6	7.2	6.6	6.5	220
225							6.6	6.8		6.9	6.7	6.6	7.1	6.6	6.5	225
230							6.5	6.8		6.8	6.6	6.2	6.9	6.6	6.5	230
235							4.4	6.6		6.6	6.6		6.8	6.6	6.5	235
240										6.6	6.6		6.7	6.6	6.5	240
245										5.7	6.6		6.6	6.6	5.9	245
250										2.8	5.1		6.5	6.5		250
255													6.2	6.4		255
260													4.4	6.2		260
265													3.9	4		265

t\_240\_002\_56401\_00\_000

# Lifting capacities Forces de levage

**TNZK**



**Preliminary  
Préliminaire**

ft	208 ft			224 ft			240 ft			253 ft			256 ft			ft	
	87 ft			87 ft			87 ft			87 ft			87 ft				
	0°	20°	40°	0°	20°	40°	0°	20°	40°	0°	20°	40°	0°	20°	40°		
50	13.1															50	
55	13.1			11.2												55	
60	13.1			11.3			9.4									60	
65	13			11.3			9.5				7.8			7.5		65	
70	12.9			11.2			9.5				8.1			7.8		70	
75	12.7			11.1			9.5				8.2			7.9		75	
80	12.5	10.6		11			9.5				8.2			7.9		80	
85	12.3	10.4		10.9			9.4				8.1			7.9		85	
90	12.1	10.1		10.8	9.4		9.3				8			7.8		90	
95	11.9	9.9		10.6	9.2		9.2	8.4			7.9			7.7		95	
100	11.7	9.7		10.5	9		9.1	8.3			7.9	7.4		7.7		100	
105	11.4	9.4	7.6	10.3	8.8		9	8.1			7.8	7.3		7.6	7.3	105	
110	11.2	9.2	7.4	10.2	8.7	7.1	8.9	8			7.7	7.3		7.6	7.3	110	
115	11	9	7.3	10	8.5	7.1	8.8	7.9	6.7		7.7	7.3		7.5	7.2	115	
120	10.8	8.8	7.2	9.9	8.4	7	8.7	7.7	6.7		7.6	7.2		7.5	7.1	120	
125	10.6	8.6	7.1	9.7	8.2	6.9	8.6	7.6	6.7		7.6	7.1	6.4	7.5	7	6.4	125
130	10.4	8.5	7	9.6	8	6.8	8.5	7.5	6.6		7.6	7	6.4	7.4	6.9	6.3	130
135	10.2	8.3	7	9.4	7.9	6.8	8.4	7.4	6.5		7.5	6.9	6.3	7.4	6.9	6.3	135
140	10	8.1	6.9	9.3	7.8	6.7	8.3	7.3	6.5		7.4	6.8	6.3	7.3	6.8	6.2	140
145	9.8	8	6.8	9.1	7.6	6.7	8.2	7.2	6.4		7.2	6.8	6.2	7.1	6.7	6.2	145
150	9.5	7.8	6.7	9	7.5	6.6	8.1	7.1	6.4		7.1	6.7	6.2	7	6.6	6.2	150
155	9.3	7.7	6.7	8.8	7.4	6.5	8	7	6.4		6.9	6.6	6.1	6.9	6.5	6.1	155
160	9.1	7.5	6.6	8.6	7.3	6.5	7.8	6.9	6.3		6.8	6.4	6.1	6.7	6.4	6.1	160
165	8.9	7.4	6.6	8.5	7.2	6.5	7.6	6.8	6.3		6.7	6.3	6	6.6	6.3	6	165
170	8.7	7.3	6.5	8.3	7.1	6.4	7.4	6.7	6.2		6.5	6.2	6	6.4	6.1	5.9	170
175	8.5	7.2	6.5	8.1	7	6.4	7.3	6.7	6.2		6.3	6	5.9	6.3	6	5.9	175
180	8.3	7.1	6.5	8	6.9	6.4	7.1	6.6	6.2		6.1	5.9	5.8	6.1	5.9	5.8	180
185	8.1	7	6.4	7.8	6.8	6.3	6.9	6.5	6.2		6	5.7	5.7	5.9	5.7	5.7	185
190	8	6.9	6.4	7.7	6.7	6.3	6.8	6.4	6.2		5.8	5.6	5.6	5.7	5.6	5.5	190
195	7.8	6.8	6.4	7.5	6.7	6.3	6.6	6.3	6.1		5.6	5.5	5.5	5.5	5.5	5.4	195
200	7.7	6.7	6.4	7.4	6.6	6.3	6.5	6.2	6.1		5.4	5.4	5.4	5.3	5.4	5.3	200
205	7.5	6.7	6.4	7.2	6.5	6.3	6.3	6	6		5.2	5.3	5.3	5.2	5.3	5.2	205
210	7.4	6.6	6.4	7.1	6.5	6.3	6.2	5.9	5.9		5	5.1	5.2	5	5.1	5.2	210
215	7.2	6.6	6.4	6.9	6.5	6.3	6.1	5.8	5.8		4.8	5	5.1	4.8	5	5.1	215
220	7.1	6.5	6.4	6.8	6.4	6.3	5.9	5.7	5.7		4.7	4.8	5	4.6	4.8	4.9	220
225	6.9	6.5	6.4	6.6	6.4	6.3	5.8	5.6	5.6		4.5	4.7	4.8	4.5	4.7	4.8	225
230	6.8	6.5	6.4	6.5	6.3	6.3	5.6	5.5	5.6		4.3	4.5	4.7	4.3	4.5	4.7	230
235	6.7	6.4	6.4	6.3	6.2	6.3	5.4	5.4	5.5		4.1	4.3	4.6	4.1	4.3	4.6	235
240	6.4	6.4	6.4	6	6.1	6.3	5.3	5.3	5.4		4	4.2	4.4	3.8	4.1	4.4	240
245	6	6.3	6.4	5.8	6	6.2	5.1	5.2	5.3		3.8	4	4.3	3.6	4	4.3	245
250	5.6	6.1	6.4	5.5	5.8	6.1	4.9	5	5.2		3.6	3.9	4.1	3.3	3.8	4.1	250
255	5.4	5.8	6	5.1	5.6	5.8	4.7	4.9	5.1		3.5	3.7	3.9	3	3.6	3.9	255
260	5.2	5.4	5.5	4.6	5.4	5.5	4.5	4.8	4.9		3.3	3.6	3.8	2.8	3.3	3.7	260
265	5.1	5.2		4.4	5	5.2	4.2	4.6	4.8		3.1	3.4	3.6		3.1	3.3	265
270	4.9	5		4.2	4.4	4.6	3.9	4.5	4.6			3.2	3.4		2.8	3	270
275	3.7	4.8		4.1	4.2	4.4	3.4	4.2	4.4			3	3.2		2.5	2.7	275
280		3.6		4	4.1		2.8	3.8	4			2.8	3			2.3	280
285				3.8	3.9			3.3	3.4				2.6				285
290				2.3	3.8			2.4	2.5								290

t\_240\_002\_56401\_00\_000



# Lifting heights Hauteurs de levage

**TNZK**

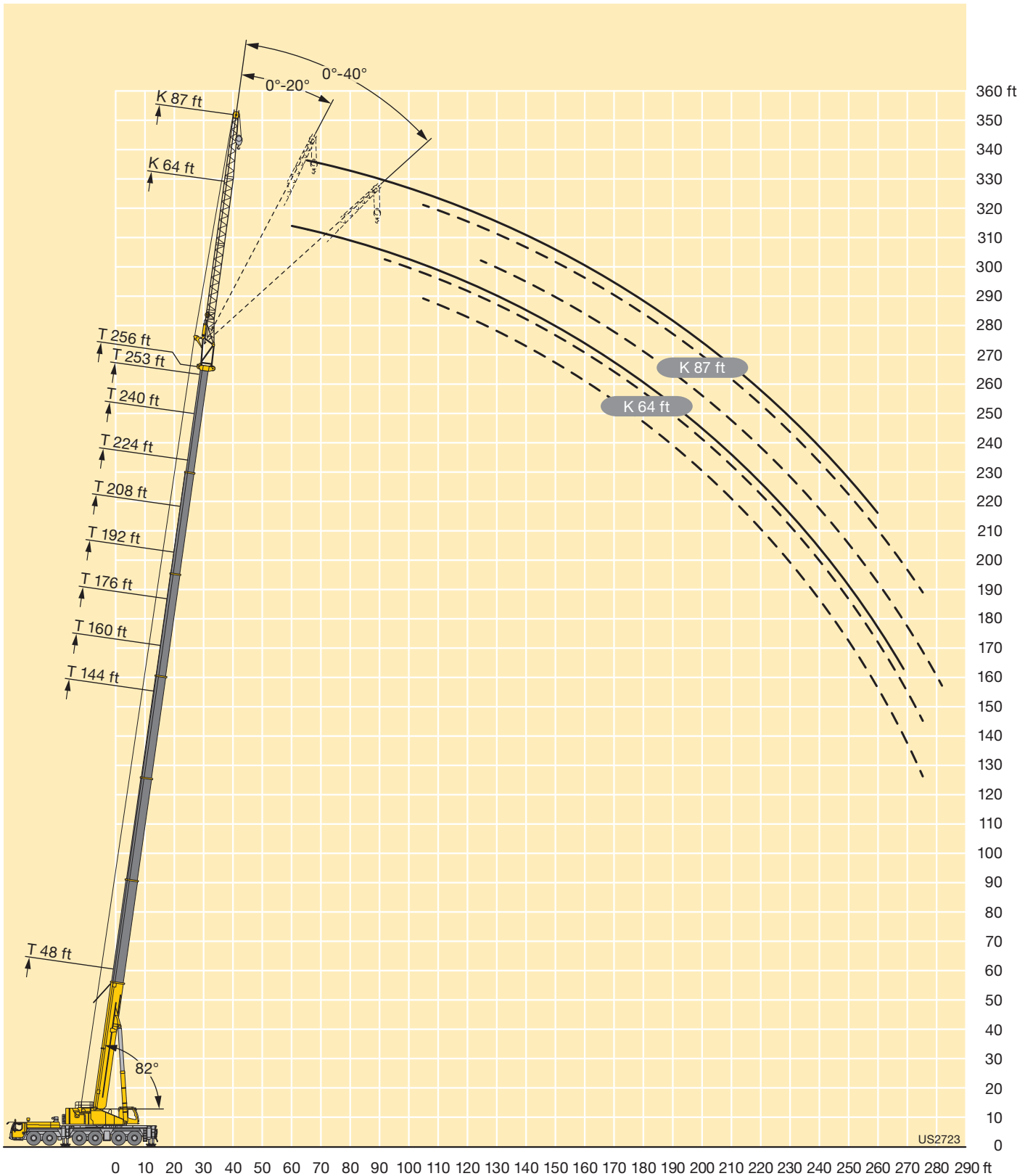

# Lifting capacities Forces de levage

**TNZK**



**Preliminary  
Préliminaire**

ft	48 ft			144 ft			160 ft			176 ft			192 ft			ft
	92 ft			92 ft			92 ft			92 ft			92 ft			
	0°	20°	40°	0°	20°	40°	0°	20°	40°	0°	20°	40°	0°	20°	40°	
15	15.9															15
16	15.9															16
17	15.9															17
18	15.9															18
19	15.9															19
20	16															20
22	15.9															22
24	15.9															24
26	15.8															26
28	15.6															28
30	15.4															30
32	15.2			15.4												32
34	15			15.8												34
36	14.8			15.9			14.9									36
38	14.5			16			15.1									38
40	14.3			15.9			15.2			14.1						40
45	13.7			15.9			15.2			14.2			12.9			45
50	13.1	11.6		15.7			15			14.2			13			50
55	12.5	10.9		15.4			14.8			14			13			55
60	11.9	10.3		15.1			14.6			13.8			12.9			60
65	11.2	9.7		14.8	12		14.3			13.6			12.7			65
70	10.6	9.2	7.8	14.4	11.6		14	11.5		13.3			12.5			70
75	10.1	8.8	7.5	14.1	11.2		13.7	11.1		13.1	10.9		12.3			75
80	9.5	8.3	7.2	13.7	10.8		13.4	10.7		12.8	10.5		12.1	10.2		80
85	9	8	7	13.4	10.5		13.1	10.4		12.6	10.2		11.9	9.9		85
90	8.5	7.6	6.8	13	10.1	7.8	12.8	10.1	7.8	12.3	9.9		11.6	9.7		90
95	8.1	7.3	6.7	12.6	9.8	7.6	12.5	9.8	7.6	12.1	9.7	7.5	11.4	9.4		95
100	7.7	7	6.5	12.3	9.5	7.5	12.2	9.5	7.4	11.8	9.4	7.4	11.2	9.2	7.2	100
105	7.3	6.8	6.4	11.9	9.2	7.3	11.9	9.3	7.3	11.5	9.1	7.2	11	8.9	7.1	105
110	7	6.6	6.3	11.5	9	7.2	11.5	9	7.2	11.3	8.9	7.1	10.8	8.7	7	110
115	6.7	6.5	6.3	11.2	8.7	7.1	11.2	8.8	7.1	11	8.7	7	10.6	8.5	6.9	115
120	6.5	6.4	6.3	10.8	8.5	7	10.9	8.5	6.9	10.7	8.5	6.9	10.4	8.3	6.8	120
125	6.2	6.3	6.3	10.5	8.2	6.9	10.6	8.3	6.8	10.4	8.3	6.8	10.1	8.1	6.7	125
130	6	6.3		10.1	8	6.8	10.3	8.1	6.7	10.2	8.1	6.7	9.9	8	6.6	130
135				9.8	7.8	6.7	9.9	7.9	6.7	9.9	7.9	6.6	9.7	7.8	6.6	135
140				9.4	7.6	6.6	9.7	7.7	6.6	9.7	7.7	6.6	9.4	7.6	6.5	140
145				9.2	7.4	6.5	9.3	7.5	6.5	9.4	7.5	6.5	9.2	7.5	6.4	145
150				8.8	7.3	6.5	9.1	7.4	6.4	9.1	7.4	6.4	9	7.3	6.4	150
155				8.6	7.2	6.4	8.8	7.2	6.4	8.9	7.3	6.4	8.8	7.2	6.3	155
160				8.3	7	6.4	8.6	7.1	6.3	8.6	7.1	6.3	8.6	7	6.3	160
165				8	6.9	6.3	8.3	7	6.3	8.4	7	6.3	8.4	6.9	6.2	165
170				7.8	6.8	6.3	8.1	6.9	6.3	8.2	6.9	6.2	8.2	6.8	6.1	170
175				7.6	6.7	6.3	7.8	6.7	6.2	8	6.8	6.2	7.9	6.7	6.1	175
180				7.4	6.6	6.3	7.6	6.7	6.2	7.8	6.7	6.1	7.8	6.6	6.1	180
185				7.2	6.5	6.3	7.5	6.6	6.2	7.6	6.6	6.1	7.6	6.6	6.1	185
190				7	6.4	6.3	7.3	6.5	6.2	7.4	6.5	6.1	7.4	6.5	6	190
195				6.8	6.4	6.3	7.1	6.4	6.2	7.2	6.4	6.1	7.3	6.4	6	195
200				6.7	6.3	6.3	7	6.4	6.2	7.1	6.4	6.1	7.1	6.4	6	200
205				6.5	6.3	6.3	6.8	6.3	6.2	7	6.3	6.1	7	6.3	6	205
210				6.4	6.3	5.4	6.7	6.3	6.2	6.8	6.3	6.1	6.9	6.2	6	210
215				6.2	6.3		6.6	6.2	6.2	6.7	6.2	6.1	6.8	6.2	6	215
220				6.1	6.3		6.4	6.2	6.2	6.6	6.2	6.1	6.7	6.1	6	220
225				5.7	6.3		6.3	6.2	5.1	6.5	6.2	6.1	6.6	6.1	6	225
230							6.2	6.2		6.4	6.2	6.1	6.5	6.1	6	230
235							6.1	6.2		6.3	6.2	6	6.4	6.1	6	235
240							4.1	6.2		6.2	6.2		6.3	6.1	6	240
245										6.1	6.2		6.2	6.1	6	245
250										5.4	6.2		6.1	6.1	5.7	250
255										2.6	4.9		6	6		255
260													5.9	6		260
265													4.1	6		265
270													3.8	3.9		270

t\_240\_002\_56501\_00\_000

# Lifting capacities Forces de levage

**TNZK**



**Preliminary  
Préliminaire**

ft	208 ft			224 ft			240 ft			253 ft			256 ft			ft
	92 ft			92 ft			92 ft			92 ft			92 ft			
	0°	20°	40°	0°	20°	40°	0°	20°	40°	0°	20°	40°	0°	20°	40°	
50	11.5															50
55	11.5			9.9												55
60	11.5			10.1			8.2									60
65	11.5			10.2			8.5			6.9						65
70	11.4			10.1			8.7			7.2			6.9			70
75	11.2			10			8.7			7.4			7.2			75
80	11.1			9.9			8.6			7.5			7.3			80
85	10.9	9.4		9.8			8.5			7.5			7.4			85
90	10.7	9.2		9.7	8.5		8.4			7.5			7.3			90
95	10.6	9		9.6	8.4		8.4			7.4			7.3			95
100	10.4	8.8		9.4	8.2		8.3	7.5		7.4			7.3			100
105	10.3	8.6		9.3	8.1		8.2	7.4		7.3	6.9		7.2	6.8		105
110	10.1	8.4	6.9	9.2	7.9		8.1	7.3		7.3	6.8		7.2	6.8		110
115	9.9	8.2	6.8	9.1	7.7	6.6	8	7.2		7.2	6.8		7.1	6.7		115
120	9.7	8	6.7	8.9	7.6	6.5	7.9	7.1	6.2	7.2	6.7		7	6.6		120
125	9.6	7.9	6.6	8.8	7.5	6.4	7.8	7	6.2	7.1	6.6		7	6.5		125
130	9.4	7.7	6.5	8.7	7.3	6.3	7.7	6.9	6.1	7	6.5	5.9	6.9	6.5	5.8	130
135	9.2	7.6	6.4	8.6	7.2	6.3	7.7	6.8	6.1	7	6.4	5.9	6.9	6.4	5.8	135
140	9	7.4	6.4	8.4	7.1	6.2	7.6	6.7	6	6.9	6.4	5.8	6.8	6.3	5.8	140
145	8.8	7.3	6.3	8.3	7	6.2	7.5	6.6	6	6.8	6.3	5.8	6.7	6.2	5.8	145
150	8.7	7.1	6.3	8.1	6.9	6.1	7.4	6.6	5.9	6.7	6.2	5.7	6.6	6.2	5.7	150
155	8.5	7	6.2	8	6.8	6.1	7.3	6.5	5.9	6.6	6.2	5.7	6.5	6.1	5.7	155
160	8.3	6.9	6.2	7.9	6.7	6	7.2	6.4	5.9	6.5	6.1	5.7	6.4	6.1	5.7	160
165	8.1	6.8	6.1	7.7	6.6	6	7.1	6.3	5.8	6.4	6	5.7	6.4	6	5.6	165
170	7.9	6.7	6.1	7.6	6.5	5.9	7	6.3	5.8	6.3	5.9	5.6	6.2	5.9	5.6	170
175	7.8	6.7	6	7.4	6.4	5.9	6.9	6.2	5.8	6.2	5.8	5.6	6.1	5.8	5.6	175
180	7.6	6.6	6	7.3	6.4	5.9	6.8	6.1	5.7	6	5.7	5.6	6	5.7	5.6	180
185	7.4	6.5	6	7.2	6.3	5.9	6.7	6.1	5.7	5.8	5.6	5.5	5.8	5.6	5.5	185
190	7.3	6.4	5.9	7.1	6.2	5.8	6.6	6	5.7	5.7	5.5	5.4	5.6	5.5	5.4	190
195	7.1	6.3	5.9	7	6.2	5.8	6.5	6	5.7	5.5	5.4	5.3	5.5	5.4	5.3	195
200	7	6.3	5.9	6.8	6.1	5.8	6.3	5.9	5.7	5.3	5.3	5.3	5.3	5.3	5.2	200
205	6.9	6.2	5.9	6.7	6.1	5.8	6.2	5.8	5.7	5.1	5.2	5.2	5.1	5.1	5.2	205
210	6.8	6.2	5.9	6.6	6	5.8	6.1	5.7	5.7	5	5	5.1	4.9	5	5.1	210
215	6.7	6.1	5.9	6.5	6	5.8	5.9	5.6	5.6	4.8	4.9	5	4.8	4.9	5	215
220	6.6	6	5.9	6.5	5.9	5.8	5.8	5.5	5.6	4.6	4.8	4.9	4.6	4.7	4.9	220
225	6.5	6	5.9	6.4	5.9	5.8	5.7	5.5	5.5	4.5	4.6	4.8	4.4	4.6	4.8	225
230	6.4	6	5.9	6.3	5.9	5.8	5.5	5.4	5.4	4.3	4.5	4.7	4.3	4.5	4.7	230
235	6.4	6	5.9	6.2	5.8	5.8	5.4	5.3	5.4	4.1	4.3	4.6	4.1	4.3	4.6	235
240	6.3	5.9	5.9	6	5.8	5.8	5.2	5.2	5.3	4	4.2	4.5	3.9	4.1	4.4	240
245	6.1	5.9	5.9	5.8	5.7	5.8	5.1	5.1	5.2	3.8	4	4.3	3.7	4	4.3	245
250	5.8	5.9	5.9	5.6	5.7	5.8	4.9	5	5.1	3.7	3.9	4.1	3.4	3.8	4.1	250
255	5.4	5.8	5.9	5.3	5.6	5.8	4.7	4.9	5	3.5	3.7	4	3.2	3.6	4	255
260	5.3	5.6	5.8	4.9	5.5	5.7	4.5	4.7	4.9	3.3	3.6	3.8	2.9	3.4	3.8	260
265	5.1	5.2	5.3	4.4	5.2	5.4	4.3	4.6	4.8	3.2	3.4	3.6	2.6	3.2	3.5	265
270	4.9	5.1		4.2	4.8	5	4.1	4.5	4.6	3	3.3	3.5	2.4	3	3.2	270
275	4.7	4.9		4.1	4.2	4.4	3.7	4.3	4.4	2.7	3.1	3.3		2.7	2.9	275
280	3.6	4.7		3.9	4.1	4.2	3.2	4.1	4.2		2.9	3.1		2.4	2.5	280
285		3.5		3.8	4		2.8	3.7	3.8		2.8	3			2.2	285
290				3.6	3.8		2.1	3.1	3.3			2.7				290
295					3.6			2.6	2.7							295

t\_240\_002\_56501\_00\_000

# Lifting capacities Forces de levage

**TNZK**



**Preliminary  
Préliminaire**

ft	48 ft			144 ft			160 ft			176 ft			192 ft			ft
	115 ft			115 ft			115 ft			115 ft			115 ft			
	0°	20°	40°	0°	20°	40°	0°	20°	40°	0°	20°	40°	0°	20°	40°	
19	9.1															19
20	9.1															20
22	9.2															22
24	10.1															24
26	10.8															26
28	11.2															28
30	11.1															30
32	10.9															32
34	10.8															34
36	10.6			9.3												36
38	10.5			9.7												38
40	10.3			10			9.1									40
45	9.9			10.7			9.8			8.7						45
50	9.5			11			10.3			9.2			7.8			50
55	9			10.9			10.4			9.6			8.3			55
60	8.6	7.4		10.7			10.3			9.7			8.7			60
65	8.2	7		10.4			10			9.5			8.8			65
70	7.7	6.6		10.2			9.8			9.4			8.7			70
75	7.2	6.3		9.9			9.6			9.2			8.6			75
80	6.8	6		9.7	7.3		9.4	7.2		9			8.4			80
85	6.5	5.7		9.4	7.1		9.2	7		8.8	6.9		8.2			85
90	6.1	5.5	4.8	9.1	6.9		8.9	6.8		8.6	6.7		8.1	6.4		90
95	5.8	5.2	4.6	8.8	6.6		8.7	6.6		8.4	6.5		7.9	6.3		95
100	5.6	5	4.5	8.6	6.4		8.4	6.4		8.2	6.3		7.7	6.2		100
105	5.3	4.8	4.3	8.3	6.2	4.6	8.2	6.2		7.9	6.1		7.5	6		105
110	5.1	4.6	4.2	8	6.1	4.5	7.9	6	4.5	7.7	6		7.4	5.8		110
115	4.9	4.4	4.1	7.7	5.9	4.5	7.7	5.9	4.5	7.5	5.8	4.4	7.2	5.7		115
120	4.7	4.3	3.9	7.4	5.7	4.4	7.4	5.7	4.4	7.3	5.7	4.4	7	5.6	4.3	120
125	4.5	4.1	3.9	7.1	5.6	4.4	7.2	5.6	4.4	7.1	5.5	4.3	6.8	5.4	4.2	125
130	4.3	4	3.8	6.9	5.4	4.3	6.9	5.4	4.3	6.9	5.4	4.2	6.7	5.3	4.2	130
135	4.2	3.9	3.8	6.6	5.3	4.2	6.7	5.3	4.2	6.7	5.3	4.2	6.5	5.2	4.1	135
140	4	3.8	3.8	6.4	5.1	4.2	6.5	5.2	4.2	6.5	5.1	4.2	6.3	5.1	4.1	140
145	3.9	3.8	3.8	6.2	5	4.2	6.3	5	4.2	6.3	5	4.1	6.2	5	4	145
150	3.8	3.8		6	4.9	4.1	6.1	4.9	4.1	6.1	4.9	4.1	6	4.8	4	150
155	3.7	3.8		5.8	4.8	4.1	5.9	4.8	4	6	4.8	4	5.9	4.7	4	155
160				5.7	4.7	4	5.8	4.7	4	5.8	4.7	4	5.7	4.6	3.9	160
165				5.5	4.6	3.9	5.6	4.6	3.9	5.7	4.6	3.9	5.6	4.6	3.9	165
170				5.3	4.5	3.9	5.5	4.5	3.9	5.5	4.5	3.9	5.5	4.5	3.8	170
175				5.2	4.4	3.9	5.3	4.4	3.8	5.3	4.4	3.8	5.3	4.4	3.8	175
180				5	4.3	3.8	5.2	4.3	3.8	5.2	4.3	3.8	5.2	4.3	3.7	180
185				4.9	4.2	3.8	5	4.2	3.8	5.1	4.3	3.7	5.1	4.2	3.7	185
190				4.8	4.1	3.8	4.9	4.2	3.8	5	4.2	3.7	4.9	4.2	3.7	190
195				4.7	4	3.8	4.8	4.1	3.7	4.9	4.1	3.7	4.8	4.1	3.6	195
200				4.5	4	3.8	4.7	4	3.7	4.7	4	3.7	4.7	4	3.6	200
205				4.4	3.9	3.8	4.6	4	3.7	4.6	4	3.6	4.6	4	3.6	205
210				4.3	3.9	3.8	4.4	3.9	3.7	4.5	3.9	3.6	4.5	3.9	3.6	210
215				4.2	3.8	3.8	4.3	3.9	3.7	4.4	3.9	3.6	4.4	3.8	3.6	215
220				4.1	3.8	3.8	4.2	3.8	3.7	4.3	3.8	3.6	4.3	3.8	3.6	220
225				4	3.8	3.8	4.2	3.8	3.7	4.3	3.8	3.6	4.2	3.8	3.6	225
230				4	3.8	3.8	4.1	3.7	3.7	4.2	3.7	3.6	4.2	3.7	3.6	230
235				3.9	3.8		4	3.7	3.7	4.1	3.7	3.6	4.1	3.7	3.6	235
240				3.8	3.8		3.9	3.7	3.7	4	3.7	3.6	4	3.6	3.6	240
245				3.8	3.8		3.9	3.7		3.9	3.7	3.6	4	3.6	3.6	245
250							3.8	3.7		3.9	3.6	3.6	3.9	3.6	3.6	250
255							3.7	3.7		3.8	3.6	3.6	3.8	3.6	3.6	255
260							3.7	3.7		3.7	3.6		3.8	3.6	3.6	260
265										3.7	3.6		3.7	3.6	3.6	265
270										3.7	3.6		3.7	3.6	3.6	270
275										2.5	3.6		3.6	3.6		275
280													3.6	3.6		280
285													3.3	3.6		285
290													2.4	3.4		290
295														2.5		295

t\_240\_002\_56601\_00\_000

# Lifting capacities Forces de levage

**TNZK**

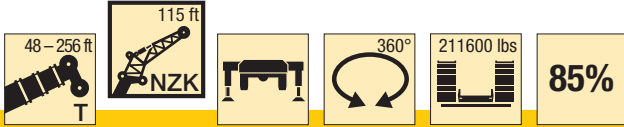

**Preliminary  
Préliminaire**

ft	208 ft			224 ft			240 ft			253 ft			256 ft			ft
	115 ft			115 ft			115 ft			115 ft			115 ft			
	0°	20°	40°	0°	20°	40°	0°	20°	40°	0°	20°	40°	0°	20°	40°	
55	6.7															55
60	7.1			5.6												60
65	7.5			5.9			4.6									65
70	7.6			6.3			4.8									70
75	7.7			6.5			5.1			4			3.8			75
80	7.6			6.6			5.3			4			3.8			80
85	7.5			6.6			5.4			4.1			3.8			85
90	7.3			6.6			5.5			4.2			3.8			90
95	7.2			6.6			5.6			4.3			3.8			95
100	7.1	5.9		6.5			5.6			4.3			3.9			100
105	7	5.8		6.4	5.4		5.6			4.3			3.9			105
110	6.8	5.6		6.3	5.3		5.6			4.3			3.9			110
115	6.7	5.5		6.2	5.2		5.5	4.7		4.3			3.9			115
120	6.6	5.4		6.1	5.1		5.5	4.7		4.4	4.2		3.9	4.1		120
125	6.5	5.3	4.1	6	5		5.4	4.7		4.4	4.2		3.9	4.1		125
130	6.3	5.1	4	5.9	4.9		5.3	4.6		4.4	4.2		3.9	4.1		130
135	6.2	5	4	5.8	4.8	3.8	5.3	4.5		4.4	4.2		3.9	4.1		135
140	6.1	4.9	4	5.6	4.7	3.8	5.2	4.4	3.6	4.4	4.1		3.9	4		140
145	5.9	4.8	3.9	5.5	4.6	3.8	5.1	4.4	3.6	4.3	4.1		3.9	4		145
150	5.8	4.7	3.9	5.4	4.5	3.8	5	4.3	3.6	4.3	4	3.4	3.9	4	3.3	150
155	5.7	4.6	3.9	5.3	4.4	3.7	4.9	4.2	3.6	4.2	4	3.4	3.9	4	3.3	155
160	5.5	4.5	3.8	5.2	4.4	3.7	4.8	4.1	3.5	4.2	3.9	3.4	3.9	3.9	3.3	160
165	5.4	4.4	3.8	5.1	4.3	3.7	4.8	4.1	3.5	4.2	3.9	3.3	3.9	3.9	3.3	165
170	5.3	4.4	3.8	5	4.2	3.6	4.7	4	3.5	4.1	3.8	3.3	3.8	3.8	3.3	170
175	5.2	4.3	3.7	4.9	4.2	3.6	4.6	4	3.5	4.1	3.8	3.3	3.8	3.8	3.3	175
180	5	4.2	3.7	4.8	4.1	3.6	4.5	3.9	3.5	4	3.7	3.3	3.7	3.7	3.3	180
185	4.9	4.1	3.6	4.7	4	3.6	4.5	3.8	3.4	4	3.7	3.3	3.7	3.7	3.3	185
190	4.9	4.1	3.6	4.7	3.9	3.5	4.4	3.8	3.4	3.9	3.6	3.3	3.7	3.6	3.3	190
195	4.8	4	3.6	4.6	3.9	3.5	4.3	3.7	3.4	3.9	3.6	3.3	3.6	3.6	3.3	195
200	4.6	4	3.5	4.5	3.9	3.5	4.2	3.7	3.4	3.8	3.5	3.3	3.6	3.5	3.3	200
205	4.5	3.9	3.5	4.4	3.8	3.5	4.2	3.6	3.4	3.7	3.5	3.3	3.6	3.5	3.2	205
210	4.4	3.8	3.5	4.3	3.8	3.4	4.1	3.6	3.4	3.7	3.5	3.3	3.5	3.4	3.2	210
215	4.4	3.8	3.5	4.3	3.7	3.4	4	3.6	3.3	3.6	3.4	3.2	3.5	3.4	3.2	215
220	4.3	3.8	3.5	4.2	3.7	3.4	4	3.5	3.3	3.5	3.4	3.2	3.5	3.4	3.2	220
225	4.2	3.7	3.5	4.1	3.6	3.4	3.9	3.5	3.3	3.4	3.3	3.2	3.3	3.4	3.2	225
230	4.1	3.7	3.5	4	3.6	3.4	3.9	3.5	3.3	3.2	3.3	3.2	3.2	3.3	3.2	230
235	4.1	3.6	3.5	4	3.5	3.4	3.8	3.4	3.3	3.1	3.2	3.2	3.1	3.2	3.2	235
240	4	3.6	3.5	3.9	3.5	3.4	3.8	3.4	3.3	2.9	3.1	3.2	2.9	3.1	3.2	240
245	3.9	3.6	3.5	3.9	3.5	3.4	3.7	3.4	3.3	2.8	3	3.2	2.8	3	3.2	245
250	3.9	3.5	3.5	3.8	3.4	3.4	3.6	3.4	3.3	2.6	2.9	3.1	2.6	2.9	3.1	250
255	3.8	3.5	3.5	3.7	3.4	3.4	3.5	3.3	3.3	2.5	2.8	3.1	2.5	2.8	3	255
260	3.8	3.5	3.5	3.7	3.4	3.4	3.5	3.3	3.3	2.3	2.7	3	2.3	2.6	3	260
265	3.7	3.5	3.5	3.6	3.4	3.4	3.4	3.3	3.3	2.2	2.5	2.8		2.5	2.8	265
270	3.7	3.5	3.5	3.5	3.4	3.4	3.3	3.3	3.3		2.4	2.7		2.4	2.7	270
275	3.6	3.5	3.5	3.4	3.4	3.4	3.2	3.2	3.3		2.2	2.5		2.2	2.6	275
280	3.5	3.5	3.5	3.2	3.3	3.4	3	3.1	3.3			2.4			2.4	280
285	3.5	3.5		2.9	3.3	3.4		3.1	3.3			2.2				285
290	3.5	3.5		2.8	3.2	3.4		3	3.3							290
295	3.3	3.5		2.6	2.8	3.2		2.8	3.1							295
300	2.2	3.4		2.5	2.7				2.7							300
305		2.6			2.6											305
310					2.4											310

t\_240\_002\_56601\_00\_000

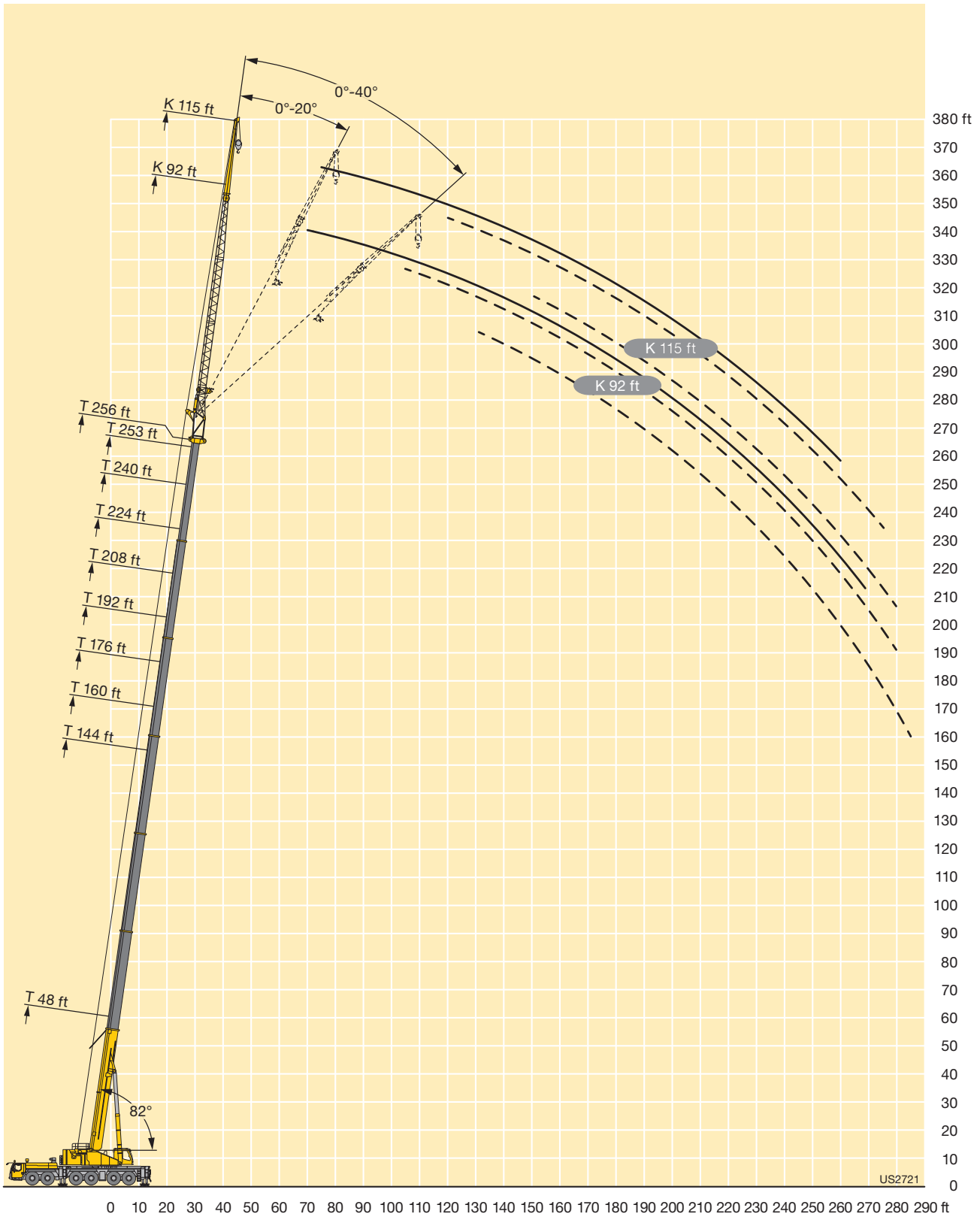







# Lifting capacities Forces de levage

TF

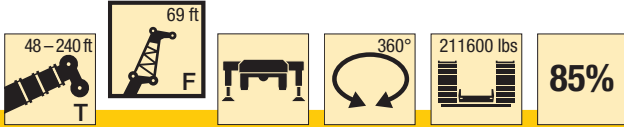

**Preliminary  
Préliminaire**

ft	48 + 6.6 ft*			144 + 6.6 ft*			160 + 6.6 ft*			176 + 6.6 ft*			192 + 6.6 ft*			208 + 6.6 ft*			224 + 6.6 ft*			240 + 6.6 ft*			ft
	69 ft			69 ft			69 ft			69 ft			69 ft			69 ft			69 ft						
	0°	20°	40°	0°	20°	40°	0°	20°	40°	0°	20°	40°	0°	20°	40°	0°	20°	40°	0°	20°	40°	0°	20°	40°	
16	38.6																							16	
17	38.6																							17	
18	38.3																							18	
19	37.8																							19	
20	37.3																							20	
22	36.1																							22	
24	34.8																							24	
26	33.6																							26	
28	32.4																							28	
30	31.3																							30	
32	30.3																							32	
34	29.3																							34	
36	28.3				38.1																			36	
38	27.3				37.6																			38	
40	26.4	23.8			36.9			34.5																40	
45	24.2	22.8			35.2			33.4			30.3													45	
50	22.2	21.4			33.4			32.1			29.6			25.4										50	
55	20.5	19.9			31.8			30.7			28.8			25.1										55	
60	18.9	18.5	17		30.3	23.7		29.4			27.8			24.8							21.3			60	
65	17.6	17.3	16.1		28.9	23		28.2	22.6		26.8			24.4							20.9			65	
70	16.3	16.1	15.3		27.5	22.2		27.1	22		25.9	21.4		24							20.7			70	
75	15.3	15.2	14.6		26.3	21.4		26	21.2		25	20.7		23.5	19.5						20.4			75	
80	14.3	14.3	13.9		25	20.6	16.9	24.9	20.5		24.1	20		22.9	19						20.1			80	
85	13.4	13.5	13.3		23.8	19.8	16.4	23.9	19.8	16.3	23.2	19.3		22.2	18.5						19.7	17.1		85	
90	12.7	12.7	12.6		22.7	19.1	16	22.9	19	15.9	22.4	18.7	15.7	21.5	17.9						19.3	16.8		90	
95	12	12.1	12.1		21.7	18.3	15.5	21.9	18.4	15.5	21.6	18.1	15.4	20.8	17.4	15					18.9	16.3		95	
100	11.4	11.5	11.6		20.7	17.7	15.2	20.9	17.8	15.2	20.8	17.5	15	20.2	16.9	14.7					18.4	15.9	14.2	100	
105	10.8	11	11.2		19.7	17	14.8	20.1	17.2	14.9	20	17	14.8	19.5	16.4	14.4					18	15.5	13.9	105	
110	10.4	10.6	10.4		18.9	16.4	14.5	19.3	16.6	14.5	19.2	16.5	14.5	18.9	16	14.2					17.5	15.1	13.7	110	
115	10.1	10.5			18.2	15.9	14.2	18.6	16.1	14.2	18.6	16	14.2	18.3	15.5	13.9					17	14.8	13.4	115	
120					17.5	15.4	13.9	17.9	15.6	13.9	18	15.5	13.9	17.7	15.1	13.6					16.6	14.4	13.1	120	
125					16.7	14.9	13.5	17.2	15.1	13.6	17.4	15.1	13.6	17.2	14.7	13.4					16.1	14.1	12.8	125	
130					16	14.4	13.2	16.6	14.7	13.3	16.8	14.7	13.3	16.7	14.3	13.1					15.6	13.8	12.6	130	
135					15.5	14	12.9	16	14.3	13	16.2	14.3	13	16.2	14	12.8					15.1	13.4	12.4	135	
140					14.9	13.6	12.6	15.4	13.8	12.8	15.8	13.9	12.8	15.7	13.7	12.6					14.7	13.1	12.2	140	
145					14.4	13.2	12.4	14.9	13.4	12.5	15.3	13.5	12.5	15.3	13.3	12.4					14.2	12.9	12	145	
150					13.9	12.8	12.1	14.4	13.1	12.3	14.8	13.2	12.3	14.9	13	12.1					13.7	12.6	11.8	150	
155					13.4	12.5	11.9	14	12.8	12.1	14.4	12.9	12.1	14.5	12.7	11.9					13.2	12.4	11.7	155	
160					13	12.2	11.7	13.5	12.5	11.9	14	12.6	11.9	14.1	12.5	11.7					12.8	12.1	11.5	160	
165					12.6	11.9	11.5	13.1	12.2	11.7	13.6	12.3	11.7	13.7	12.2	11.6					12.4	11.8	11.3	165	
170					12.2	11.6	11.4	12.7	11.9	11.5	13.2	12	11.5	13.3	11.9	11.4					12	11.6	11.2	170	
175					11.8	11.3	11.3	12.4	11.6	11.3	12.8	11.8	11.4	12.9	11.7	11.3					11.6	11.3	11.1	175	
180					11.5	11.1	11.2	12	11.4	11.2	12.5	11.5	11.3	12.6	11.5	11.1					11.2	11	10.9	180	
185					11.2	10.9	11.2	11.7	11.2	11.1	12.2	11.3	11.1	12.2	11.3	11					10.8	10.7	10.7	185	
190					10.9	10.7	11.2	11.4	11	11.1	11.8	11.1	11	11.8	11.1	10.9					10.4	10.4	10.5	190	
195					10.6	10.6		11.1	10.8	11	11.5	10.9	11	11.4	10.9	10.8					10	10.1	10.2	195	
200					10.3	10.5		10.8	10.6	11	11.2	10.7	10.9	10.8	10.7	10.7					9.6	9.7	9.9	200	
205					10.1	10.5		10.6	10.5		10.9	10.6	10.9	10.4	10.5	10.6					9.1	9.4	9.7	205	
210								10.4	10.4		10.5	10.4	10.9	9.6	10.3	10.4					8.7	9	9.4	210	
215								10.2	10.3		10.1	10.1	10.5	8.9	9.8	10.1					8.3	8.7	9.1	215	
220								7.6	10.1		9.6	9.8		8.1	9.1	9.5					7.9	8.3	8.7	220	
225								3.6			8.9	9.5		7.7	8.3	8.6					7.5	7.9	8.2	225	
230											8.3	8.7		7.4	7.6	7.7					6.9	7.5	7.7	230	
235											5.9	7.8		7.1	7.3						6.4	7.1	7.3	235	
240											2.2	3.7		6.9	7						6	6.5	6.7	240	
245														6.6	6.8						5.8	6	6.1	245	
250														4.4	6.2						5.5	5.7		250	
255														4.1	4.3						5.3	5.5		255	
260																					5.1	5.3		260	
265																					3.9	4.9		265	
270																						3.3		270	
275																								275	
280																								280	

\* adapter · pièce d'adaptateur

t\_240\_003\_50301\_00\_000 / 52301\_00\_000 / 54301\_00\_000







# Lifting capacities Forces de levage

TF

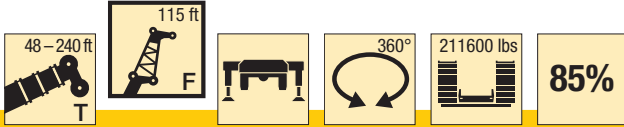

Preliminary  
Préliminaire

ft	48 + 6.6 ft*			144 + 6.6 ft*			160 + 6.6 ft*			176 + 6.6 ft*			192 + 6.6 ft*			208 + 6.6 ft*			224 + 6.6 ft*			240 + 6.6 ft*			ft
	115 ft			115 ft			115 ft			115 ft			115 ft			115 ft			115 ft						
	0°	20°	40°	0°	20°	40°	0°	20°	40°	0°	20°	40°	0°	20°	40°	0°	20°	40°	0°	20°	40°	0°	20°	40°	
24	19.6																							24	
26	19.5																							26	
28	19.2																							28	
30	18.7																							30	
32	18.2																							32	
34	17.7																							34	
36	17.2																							36	
38	16.8																							38	
40	16.4																							40	
45	15.4																							45	
50	14.5																							50	
55	13.5																							55	
60	12.7																							60	
65	11.9	10																						65	
70	11.1	9.5																						70	
75	10.5	9																						75	
80	9.8	8.5																						80	
85	9.3	8																						85	
90	8.8	7.6																						90	
95	8.3	7.2	6.2																					95	
100	7.8	6.9	6																					100	
105	7.4	6.5	5.8																					105	
110	7	6.3	5.6																					110	
115	6.6	6	5.4																					115	
120	6.3	5.8	5.2																					120	
125	6	5.6	5.1																					125	
130	5.7	5.4	5																					130	
135	5.5	5.3	4.9																					135	
140	5.2	5.1	4.9																					140	
145	5	5	4.8																					145	
150	4.8	4.9	4.8																					150	
155	4.7	4.9	4.8																					155	
160	4.6	4.8																						160	
165																								165	
170																								170	
175																								175	
180																								180	
185																								185	
190																								190	
195																								195	
200																								200	
205																								205	
210																								210	
215																								215	
220																								220	
225																								225	
230																								230	
235																								235	
240																								240	
245																								245	
250																								250	
255																								255	
260																								260	
265																								265	
270																								270	
275																								275	
280																								280	
285																								285	
290																								290	
295																								295	
300																								300	
305																								305	

\* adapter · pièce d'adaptateur

t\_240\_003\_50701\_00\_000 / 52701\_00\_000 / 54701\_00\_000





# Lifting capacities Forces de levage

**TF**

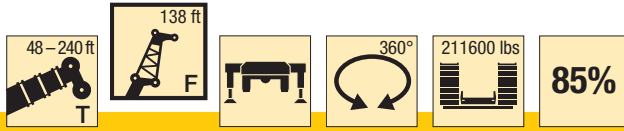

**Preliminary  
Préliminaire**

ft	48 + 6.6 ft*			144 + 6.6 ft*			160 + 6.6 ft*			176 + 6.6 ft*			192 + 6.6 ft*			208 + 6.6 ft*			224 + 6.6 ft*			240 + 6.6 ft*			ft			
	138 ft			138 ft			138 ft			138 ft			138 ft			138 ft			138 ft									
	0°	20°	40°	0°	20°	40°	0°	20°	40°	0°	20°	40°	0°	20°	40°	0°	20°	40°	0°	20°	40°	0°	20°	40°				
30	14.2																							30				
32	14																							32				
34	13.7																							34				
36	13.4																							36				
38	13.1																							38				
40	12.7																							40				
45	12																							45				
50	11.3				14																			50				
55	10.6				13.5			12.9																55				
60	10				13			12.5			11.7													60				
65	9.4				12.4			12			11.4			10.5										65				
70	8.8				11.9			11.6			11			10.2										70				
75	8.2				11.5			11.1			10.6			9.9			8.9							75				
80	7.6	6.5			11			10.7			10.2			9.6			8.7			6.9				80				
85	7.2	6.2			10.6			10.4			9.9			9.3			8.5			6.9			4.2	85				
90	6.8	5.8			10.1			10			9.6			9			8.2			6.8			4.2	90				
95	6.5	5.5			9.7			9.6			9.3			8.7			8			6.7			4.3	95				
100	6.1	5.2			9.3	6.5		9.2			8.9			8.5			7.7			6.6			4.3	100				
105	5.8	5			8.9	6.3		8.9	6.3		8.6			8.2			7.5			6.6			4.3	105				
110	5.5	4.7			8.5	6.1		8.5	6.1		8.3	6		7.9			7.2			6.5			4.3	110				
115	5.2	4.5	3.9		8.2	5.8		8.2	5.9		8	5.8		7.6			7			6.3			4.3	115				
120	4.9	4.3	3.7		7.8	5.6		7.8	5.7		7.7	5.6		7.3	5.5		6.8			6.2			4.3	120				
125	4.7	4.1	3.6		7.5	5.5		7.5	5.5		7.5	5.5		7.1	5.4		6.7	5.2		6			4.2	125				
130	4.5	3.9	3.4		7.2	5.3		7.2	5.3		7.2	5.3		6.9	5.2		6.5	5		5.9			4.2	130				
135	4.2	3.8	3.3	7	5.1	3.6		7	5.2		6.9	5.1		6.7	5		6.3	4.9		5.8	4.6		4.1	135				
140	4.1	3.6	3.2	6.7	5	3.6		6.7	5	3.6		6.7	5		6.5	4.9		6.1	4.8		5.6	4.5	4	140				
145	3.9	3.5	3.1	6.5	4.8	3.5		6.5	4.9	3.5		6.5	4.8	3.4	6.3	4.8		6	4.6		5.5	4.4	3.9	3.7	145			
150	3.7	3.3	3	6.2	4.6	3.4		6.3	4.7	3.4		6.3	4.7	3.4	6.1	4.6	3.3	5.8	4.5		5.4	4.3	3.8	3.6	150			
155	3.5	3.2	2.9	6	4.5	3.3		6.1	4.6	3.3		6.1	4.6	3.3	6	4.5	3.2	5.7	4.4		5.3	4.2	3.7	3.4	155			
160	3.3	3.1	2.9	5.8	4.4	3.3		5.9	4.4	3.3		5.9	4.5	3.2	5.8	4.4	3.2	5.5	4.3	3.1	5.2	4.1	3.5	3.3	160			
165	3.2	3	2.9	5.6	4.3	3.2		5.7	4.3	3.2		5.8	4.3	3.2	5.6	4.3	3.2	5.4	4.2	3.1	5	4	3.4	3.1	165			
170	3	3	2.9	5.4	4.1	3.1		5.5	4.2	3.2		5.6	4.2	3.1	5.5	4.2	3.1	5.2	4.1	3	4.9	3.9	3.3	3	170			
175	2.9	2.9	2.9	5.2	4	3.1		5.4	4.1	3.1		5.4	4.1	3.1	5.3	4.1	3.1	5.1	4	3	4.8	3.8	2.8	3.1	2.9	175		
180	2.8	2.9		5	3.9	3		5.2	4	3.1		5.3	4	3	5.2	4	3	5	3.9	2.9	4.7	3.8	2.8	3	2.7	2.7	180	
185	2.8			4.9	3.8	3		5	3.9	3		5.1	3.9	3	5	3.9	3	4.9	3.8	2.9	4.6	3.7	2.8	2.8	2.6	2.6	185	
190				4.7	3.7	2.9		4.9	3.8	3		5	3.8	3	4.9	3.8	2.9	4.8	3.7	2.9	4.5	3.6	2.8	2.7	2.5	2.6	190	
195				4.5	3.6	2.9		4.7	3.7	2.9		4.8	3.7	2.9	4.8	3.7	2.9	4.7	3.6	2.9	4.4	3.5	2.8	2.5	2.3	2.5	195	
200				4.4	3.5	2.9		4.6	3.6	2.9		4.7	3.6	2.9	4.7	3.6	2.9	4.6	3.6	2.8	4.3	3.5	2.7	2.4	2.2	2.4	200	
205				4.2	3.4	2.9		4.4	3.5	2.9		4.5	3.6	2.9	4.6	3.5	2.9	4.4	3.5	2.8	4.2	3.4	2.7	2.3	2.3	2.3	205	
210				4.1	3.4	2.9		4.3	3.4	2.9		4.4	3.5	2.9	4.4	3.5	2.8	4.3	3.4	2.8	4.1	3.3	2.7	2.2		2.1	210	
215				4	3.3	2.9		4.2	3.4	2.8		4.3	3.4	2.9	4.3	3.4	2.8	4.2	3.4	2.8	4	3.3	2.7				215	
220				3.8	3.2	2.9		4	3.3	2.8		4.2	3.3	2.9	4.2	3.3	2.8	4.1	3.3	2.8	3.9	3.2	2.7				220	
225				3.7	3.2	2.9		3.9	3.2	2.8		4	3.3	2.8	4.1	3.3	2.8	4.1	3.2	2.8	3.7	3.2	2.7				225	
230				3.6	3.1	2.9		3.8	3.2	2.8		3.9	3.2	2.8	4	3.2	2.8	4	3.2	2.8	3.5	3.1	2.7				230	
235				3.5	3	2.9		3.7	3.1	2.8		3.8	3.1	2.8	3.9	3.1	2.8	3.9	3.1	2.8	3.4	3.1	2.7				235	
240				3.4	3	2.9		3.6	3.1	2.8		3.7	3.1	2.8	3.8	3.1	2.8	3.8	3.1	2.8	3.2	3	2.7				240	
245				3.3	3	2.9		3.5	3	2.8		3.6	3.1	2.8	3.7	3.1	2.8	3.7	3	2.7	3.1	3	2.7				245	
250				3.2	2.9	2.9		3.4	3	2.8		3.5	3	2.8	3.6	3	2.8	3.6	3	2.7	2.9	2.9	2.7				250	
255				3.1	2.9	2.9		3.3	2.9	2.8		3.4	3	2.8	3.5	3	2.8	3.5	3	2.7	2.8	2.9	2.7				255	
260				3	2.9			3.2	2.9	2.8		3.3	2.9	2.8	3.4	2.9	2.8	3.4	2.9	2.7	2.6	2.9	2.7				260	
265				2.9	2.9			3.1	2.9	2.8		3.2	2.9	2.8	3.3	2.9	2.8	3.3	2.9	2.7	2.5	2.8	2.7				265	
270				2.9	2.9			3	2.9	2.8		3.2	2.9	2.8	3.3	2.9	2.8	3.2	2.8	2.7		2.6	2.7				270	
275				2.8	2.9			2.9	2.9			3.1	2.9	2.8	3.2	2.8	2.8	3	2.8	2.7		2.5	2.7				275	
280								2.9	2.9			3	2.8	2.8	3.1	2.8	2.8	2.7	2.8	2.7		2.3	2.6				280	
285								2.8	2.9			2.9	2.8	2.8	2.9	2.8	2.8	2.3	2.8	2.7		2.2	2.5				285	
290									2.9			2.9	2.8		2.8	2.8	2.8		2.8	2.7			2.4					290
295												2.8	2.8		2.6	2.8	2.8		2.7	2.7			2.2				295	
300													2.8		2.4	2.7			2.3	2.6							300	
305													2.2		2.1	2.5				2.2								305
310															2.3					2.2								310

\* adapter - pièce d'adaptateur

t\_240\_003\_50901\_00\_000 / 52901\_00\_000 / 54901\_00\_000

# Lifting heights Hauteurs de levage

TF

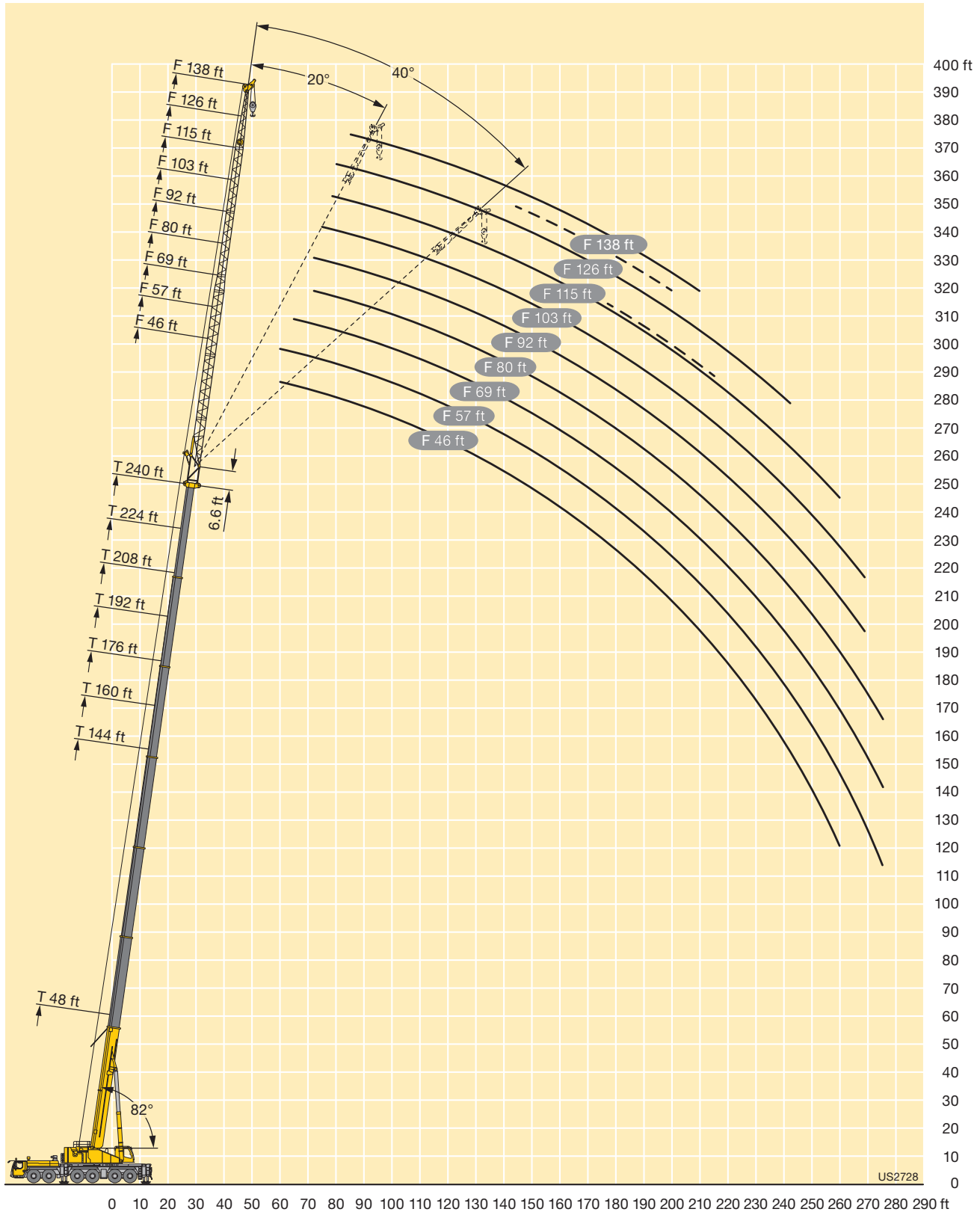



# Lifting capacities Forces de levage

TN

48-240 ft  
57 ft  
360°  
211600 lbs  
85%

Preliminary  
Préliminaire

ft	48 + 11.5 ft*			64 + 11.5 ft*			80 + 11.5 ft*			96 + 11.5 ft*			112 + 11.5 ft*			ft
	57 ft			57 ft			57 ft			57 ft			57 ft			
	82°	75°	68°	82°	75°	68°	82°	75°	68°	82°	75°	68°	82°	75°	68°	
26	110.7															26
28	110.8															28
30	110.7			103.2												30
32	110.3			103.9			93.9									32
34	109.3			104.4			94.2			82.8						34
36	108			104.8			94.4			82.8						36
38	107			104.9			94.4			82.7			70.8			38
40	106.1	105.1		104.6			94.4			82.6			70.7			40
45	103.5	98.5		102.5	100.6		94.4			82.6			70.7			45
50	95.6	93.2		100.2	97.6		94.4	91.4		82.6			70.7			50
55	83.9	89.5	86.2	90.4	94.6		93	91.1		82.6	79.8		70.7			55
60	65.5	86.5	81.6	79	91.7	89.2	85.4	89.9		82.6	79.9		70.7	68.2		60
65		78.8	78.3		88	84.7	72.9	88.8		80.5	80.4		70.7	68.2		65
70			77.2		78.3	81.6		86.4	81.7		80.8		70.7	68.2		70
75			72.9			79		78	75.9		78.5	73.1		68.2		75
80						73.7			70.7		73.2	68.2		68.2		80
85									66			63.7		65.9	60.1	85
90												59.7			56.4	90
95															53	95
100															49.9	100

\* adapter · pièce d'adaptateur

t\_240\_004\_50101\_00\_000

48-240 ft  
57 ft  
360°  
211600 lbs  
85%

Preliminary  
Préliminaire

ft	128 + 11.5 ft*			144 + 11.5 ft*			160 + 11.5 ft*			176 + 11.5 ft*		192 + 11.5 ft*		208 + 11.5 ft*	224 + 11.5 ft*	240 + 11.5 ft*	ft
	57 ft			57 ft			57 ft			57 ft		57 ft		57 ft	57 ft	57 ft	
	82°	75°	68°	82°	75°	68°	82°	75°	68°	82°	75°	82°	75°	82°	82°	82°	
40	60.7																40
45	60.6			49.7													45
50	60.5			49.6			39.3										50
55	60.5			49.6			39.2			32.2		25					55
60	60.5			49.6			39			32.1		24.9		18.7			60
65	60.5	58.4		49.6			38.9			32		24.9		18.7	12.7	7.7	65
70	60.5	58.5		49.6			38.9			31.9		24.8		18.6	12.6	7.6	70
75		58.8		49.6	48		38.9			31.9		24.8		18.5	12.4	7.4	75
80		59.1			48.1			37.8				24.8		18.4	12.3	7.3	80
85		59.1			48			37.6			30.3				12.2	7.2	85
90		59			47			37.4			30.2						90
95			54.3					37.3			30		23.2				95
100			48.2								29.9		23.1				100
105			45.5										23				105
110						40.6											110
115						39.2											115
						37.9											
									33								
									31.8								
									30.9								

\* adapter · pièce d'adaptateur

t\_240\_004\_50101\_00\_000

# Lifting capacities Forces de levage

TN



**Preliminary  
Préliminaire**

ft	48 + 11.5 ft*			64 + 11.5 ft*			80 + 11.5 ft*			96 + 11.5 ft*			112 + 11.5 ft*			ft
	69 ft			69 ft			69 ft			69 ft			69 ft			
	82°	75°	68°	82°	75°	68°	82°	75°	68°	82°	75°	68°	82°	75°	68°	
30	97.7															30
32	97.6			91.4												32
34	97.1			91.5												34
36	96.2			91.6			83.4									36
38	95.1			91.4			83.2			73.4						38
40	94			91.1			83.1			73.4						40
45	91.5	90.3		89.5			82.8			73.1			63.4			45
50	89.4	86.9		87.9	86.8		82.6			73			63.3			50
55	87.9	83		86.8	84.4		82.3	80.5		73			63.3			55
60	83.7	79.6	77.8	85.6	82.5		81.9	79.2		73	70.9		63.3			60
65	73.7	77.3	73.7	81.2	80.8	79.3	81.9	77.7		73	70.8		63.3	61.3		65
70	57.8	75.9	70.6	69.3	79.6	76.3	77	76.6		73	70.6		63.3	61.2		70
75		70.6	68.4	51.8	79.2	73.6	64.4	76	74.2	73	69.9		63.3	61.2		75
80			67.7		71.4	71.4		74.8	70.3		69.7	67.6	63.3	61.2		80
85			65.8			68.6		69.9	65.7		68.3	63.5		61.2		85
90						64.4			61.6		64.2	59.6		60.8	55.9	90
95								57.9				56		58	52.6	95
100												52.9			49.7	100
105															46.9	105
110															44.4	110

\* adapter · pièce d'adaptateur

t\_240\_004\_50201\_00\_000

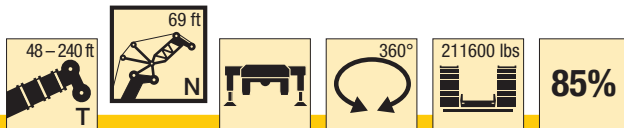

**Preliminary  
Préliminaire**





ft	128 + 11.5 ft*			144 + 11.5 ft*			160 + 11.5 ft*			176 + 11.5 ft*			192 + 11.5 ft*			208 + 11.5 ft*		224 + 11.5 ft*		240 + 11.5 ft*		ft
	69 ft			69 ft			69 ft			69 ft			69 ft			69 ft		69 ft		69 ft		
	82°	75°	68°	82°	75°	68°	82°	75°	68°	82°	75°	68°	82°	75°	68°	82°	75°	82°	75°	82°	75°	
45	54.5																					45
50	54.5			44.9			34.6															50
55	54.5			44.9			34.5		28.3													55
60	54.5			44.9			34.2		28.2			21.5										60
65	54.5			44.9			34		28			21.4		15.9								65
70	54.5	52.7		44.9			33.9		27.9			21.3		15.7		10.3		5.9				70
75	54.5	52.8		44.9			33.8		27.8			21.3		15.6		10.1		5.8				75
80	54.5	52.9		44.9	43.3		33.8		27.8			21.3		15.4		10		5.7				80
85		53.1		44.9	43		33.8	32.9	27.7			21.3		15.3		9.9		5.6				85
90		53.3			42.9			32.7	26.8			21.3		15.3		9.8		5.5				90
95		53.6	50.5		42.7			32.6	26.7					15.3		9.8		5.5				95
100		52.9	47.7		42			32.5	26.6													100
105			45.1		41.2	37.5		32.5	26.5				20.2									105
110			42.7			36.3			26.5					20								110
115			40.5			35.2			29.4					19.9								115
120						34.2			28.5													120
125									27.7													125
130										22.4												130
135										21.7												135
140										21.1												140

\* adapter · pièce d'adaptateur

t\_240\_004\_50201\_00\_000

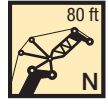
# Lifting capacities Forces de levage

TN





48-224 ft  80 ft  N   360°  211600 lbs  85%

**Preliminary**  
**Préliminaire**

ft	48 + 11.5 ft*			64 + 11.5 ft*			80 + 11.5 ft*			96 + 11.5 ft*			112 + 11.5 ft*			ft
	80 ft			80 ft			80 ft			80 ft			80 ft			
	82°	75°	68°	82°	75°	68°	82°	75°	68°	82°	75°	68°	82°	75°	68°	
34	85.6															34
36	85.3			80.1												36
38	84.3			79.9												38
40	83.4			79.7			72.9									40
45	81.2			78.9			72.6			64.6			56.3			45
50	79.3	78.7		77.5			72.4			64.4			56.2			50
55	77.5	76.4		76.2	75.4		72			64.4			56.1			55
60	76.2	73.7		75	73.7		71.1	70.4		64.4			56.1			60
65	74.5	71.2	70.1	74.3	71.9		70.5	68.9		64.4	62.5		56.1			65
70	70.6	68.8	67	72.6	70.6		70.3	67.6		64.4	62.4		56.1	54.4		70
75	62.6	67.1	64	68.3	69.5	68.5	70.3	66.7		64.4	61.9		56.1	54.3		75
80	51.6	65.8	61.7	59.7	68.8	66.2	66.2	66	65.1	64.4	61.2		56.1	54.3		80
85		61	59.9	48.5	67.9	64.4	57.4	65.6	63.7	64.3	60.7		56.1	54.3		85
90		49.3	59.4		61.5	62.8		65	61.5	54.4	60.6	58.7	56.1	54.3		90
95			57.7		50.8	60.4		61.7	57.9		60.1	55.7		54.3	52.1	95
100						57			54.6		56.8	52.6		53.9	49.3	100
105									51.6			49.7		51.5	46.6	105
110									48.9			47.1			44.2	110
115												44.7			41.9	115
120															39.9	120

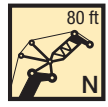
\* adapter · pièce d'adaptateur

t\_240\_004\_50301\_00\_000

48-224 ft  80 ft  N   360°  211600 lbs  85%

**Preliminary**  
**Préliminaire**

ft	128 + 11.5 ft*			144 + 11.5 ft*			160 + 11.5 ft*			176 + 11.5 ft*			192 + 11.5 ft*			208 + 11.5 ft*			224 + 11.5 ft*		ft
	80 ft			80 ft			80 ft			80 ft			80 ft			80 ft			80 ft		
	82°	75°	68°	82°	75°	68°	82°	75°	68°	82°	75°	68°	82°	75°	68°	82°	75°	68°	82°	75°	
50	48.5																				50
55	48.5			40.4			30.4														55
60	48.4			40.4			30.2			24.3											60
65	48.4			40.3			30.1			24.3			19								65
70	48.4			40.3			29.9			24.2			19			13.5			8.4		70
75	48.4	46.9		40.3			29.7			24.1			18.9			13.3			8.3		75
80	48.4	46.9		40.3			29.6			24			18.9			13.2			8.1		80
85	48.4	47		40.3	38.7		29.6			23.9			18.9			13.1			8		85
90	48.4	47		40.3	38.5		29.6	28.8		23.9			18.9			13			8		90
95	48.4	47		40.3	38.4		29.6	28.7		23.9	23.2		18.9			12.9			7.9		95
100		47		38.4			29.6	28.6		23.9	23.2		18.9			12.9			7.9		100
105		47	45	38.2			28.6			23.1			17.7			12.9			7.9		105
110		47	42.6	37.8	34.5		28.6			23.1			17.6			11.7					110
115			40.5	37.2	33.8		28.6			23.1			17.5			11.7					115
120			38.5		32.8		28.6	27.1		23.1			17.4			11.6			6.8		120
125			36.7		31.9			26.3		23.1			17.4			11.5			6.7		125
130					31			25.6			20.5					11.5			6.7		130
135								25			19.9								6.6		135
140								24.4			19.4			14.8							140
145											18.9			14.4							145
150														14							150
155																			10.3		155

\* adapter · pièce d'adaptateur

t\_240\_004\_50301\_00\_000

# Lifting capacities Forces de levage

TN

**Preliminary  
Préliminaire**

ft	48 + 11.5 ft*			64 + 11.5 ft*			80 + 11.5 ft*			96 + 11.5 ft*			112 + 11.5 ft*			ft	
	92 ft			92 ft			92 ft			92 ft			92 ft				
	82°	75°	68°	82°	75°	68°	82°	75°	68°	82°	75°	68°	82°	75°	68°		
38	74.4															38	
40	73.8			70.3												40	
45	72			69.5			64.4									45	
50	70.3			68.5			64				57.4			50.1		50	
55	68.8	68.4		67.3			63.4				57.2			50		55	
60	67.4	66.7		66.3	65.8		62.9				56.9			49.9		60	
65	66.2	64.9		65.2	64.3		62.2	61.5			56.6			49.7		65	
70	65.4	63.3		64.5	63		61.5	60.5			56.3	54.8		49.6		70	
75	63.9	61.5	60.6	63.9	61.8		61.2	59.4			56.2	54.8		49.6	47.7	75	
80	61.2	60	58.2	62.7	60.8	60.4	61	58.6			56.1	54.4		49.6	48.1	80	
85	54.8	58.9	56	59.3	60.1	59	61	57.9	57.4		56.1	53.7		49.6	47.9	85	
90	46.6	57.7	54.3	52.7	59.6	57.7	57	57.4	56.4		56	53.3		49.6	47.8	90	
95	37.4	53.8	52.9	44.6	59.2	56.4	50.4	57.2	55.3		55.5	53	52.1	49.6	47.7	95	
100		45.7	52.5		54.3	55.4	40	56.9	54		48.4	52.8	51.4	49.6	47.7	100	
105			51.8		46.9	53.7		54.8	51.3			52.8	49.3		47.7	46.1	105
110						51		47.2	48.6			50.6	46.8		47.7	44	110
115									46.2			47.8	44.4		46.3	41.8	115
120									43.9				42.2		44	39.8	120
125													40.2			37.9	125
130																36.1	130

\* adapter · pièce d'adaptateur

t\_240\_004\_50401\_00\_000

**Preliminary  
Préliminaire**

ft	128 + 11.5 ft*			144 + 11.5 ft*			160 + 11.5 ft*			176 + 11.5 ft*			192 + 11.5 ft*			208 + 11.5 ft*			224 + 11.5 ft*		ft
	92 ft			92 ft			92 ft			92 ft			92 ft			92 ft			92 ft		
	82°	75°	68°	82°	75°	68°	82°	75°	68°	82°	75°	68°	82°	75°	68°	82°	75°	68°	82°	75°	
55	43.2			36																	55
60	43.2			36			26.2														60
65	43.2			36			26.1			21.5											65
70	43.1			36			25.9			21.4			16.8			11.3					70
75	43.1			36			25.8			21.3			16.7			11.1			6.5		75
80	43.1	40.8		36			25.7			21.2			16.5			11			6.4		80
85	43.1	41.5		36			25.5			21.2			16.4			10.9			6.3		85
90	43.1	41.8		36	34.4		25.5			21.1			16.3			10.8			6.2		90
95	43.1	41.8		36	34.5		25.5	24.8		21.1			16.2			10.7			6.1		95
100	43.1	41.8		36	34.3		25.5	24.7		21.1	20.4		16.2			10.7			6.1		100
105	43.1	41.8		36	34.3		25.5	24.7		21.1	20.3		16.2			10.6			6		105
110		41.8	39.3		34.3		25.5	24.6		21.1	20.3		16.2	15		10.6			6		110
115		41.8	39.8		34.3			24.6			20.3		16.2	14.9		10.6	9.5		6		115
120		41.8	38.1		34	31		24.6			20.3			14.8			9.5		6		120
125			36.3		33.6	30.4		24.6	23.9		20.3			14.7			9.4			5	125
130			34.6			29.6		24.6	23.7		20.3			14.7			9.3			4.9	130
135														14.7			9.3			4.9	135
140			33.1			28.8			23.4		20.3	18.7		14.7			9.3			4.9	140
145			31.6			28.1			22.9			18.2		14.7			9.3			4.9	145
150						27.4			22.3			17.8			13.4					4.9	150
155									21.8			17.3			13.1						155
160												16.9			12.7			8.5			160
165															12.3			8.4			165
170																		8.4			170

\* adapter · pièce d'adaptateur

t\_240\_004\_50401\_00\_000

# Lifting capacities Forces de levage

TN

48-224 ft  
103 ft  
360°  
211600 lbs  
85%

Preliminary  
Préliminaire

ft	48 + 11.5 ft*			64 + 11.5 ft*			80 + 11.5 ft*			96 + 11.5 ft*			112 + 11.5 ft*			ft		
	103 ft			103 ft			103 ft			103 ft			103 ft					
	82°	75°	68°	82°	75°	68°	82°	75°	68°	82°	75°	68°	82°	75°	68°			
45	63.5			60.5												45		
50	62.3			59.9				55.7				49.9				50		
55	61.1			59.3				55.3				49.6			43.7	55		
60	60	59.4		58.5				54.8				49.3			43.5	60		
65	59	58.1		57.7	57.1			54.4				49.1			43.4	65		
70	58.1	56.9		57	56.1			54	53.1			48.8			43.3	70		
75	57.5	55.8		56.5	55.1			53.6	52.7			48.6	47.2		43.2	75		
80	56.6	54.8	54.1	56.1	54.3			53.4	51.9			48.5	47.3		43.2	41.5	80	
85	54.2	53.8	52.4	55.3	53.6	53		53.2	51.3			48.4	47.1		43.1	41.9	85	
90	50.7	53.2	51	53.8	52.9	52		53.2	50.8			48.4	46.8		43.1	41.8	90	
95	45.1	52.2	49.7	49.7	52.6	51.1		53.2	50.3	49.5		48.4	46.6		43.1	41.7	95	
100	38.3	50.2	48.7	43.7	52.3	50.3		48	50.1	48.7		48.3	46.3	44.8	43.1	41.6	100	
105	31	45.1	48.1	37.3	51.7	49.8		41.9	50	48.1		47.5	46.2	44.9	43.1	41.5	105	
110		38.4	47.4		46	49.5		34.7	49.5	47.6		41.3	46.2	44.5	42.6	41.5	39.7	110
115			44.6		39.7	48.2			46.5	46			46.2	44.1	39.1	41.5	40.2	115
120			36.8			45.9			40.1	43.8			45.6	42.3		41.5	39.5	120
125						41.1				41.7			42.5	40.3		41.4	37.7	125
130										39.8				38.5		39.9	36	130
135														36.7			34.4	135
140																	32.9	140
145																	31.4	145

\* adapter · pièce d'adaptateur

t\_240\_004\_50501\_00\_000

48-224 ft  
103 ft  
360°  
211600 lbs  
85%

Preliminary  
Préliminaire

ft	128 + 11.5 ft*			144 + 11.5 ft*			160 + 11.5 ft*			176 + 11.5 ft*			192 + 11.5 ft*			208 + 11.5 ft*			224 + 11.5 ft*			ft
	103 ft			103 ft			103 ft			103 ft			103 ft			103 ft						
	82°	75°	68°	82°	75°	68°	82°	75°	68°	82°	75°	68°	82°	75°	68°	82°	75°	68°	82°	75°	68°	
55	37.9																					55
60	37.9			31.7																		60
65	37.8			31.7			23.2															65
70	37.8			31.6			23			19			14.6									70
75	37.7			31.6			22.9			18.9			14.5		9.4							75
80	37.7			31.6			22.8			18.8			14.4		9.3			5				80
85	37.7	35.9		31.6			22.6			18.7			14.2		9.1			4.9				85
90	37.7	36.2		31.6			22.5			18.7			14.1		9			4.8				90
95	37.7	36.5		31.6	30.1		22.4			18.6			14		9			4.7				95
100	37.7	36.5		31.6	30.4		22.4	21.8		18.6			13.9		8.9			4.7				100
105	37.7	36.5		31.6	30.6		22.4	21.7		18.5	18.1		13.8		8.8			4.6				105
110	37.7	36.5		31.6	30.6		22.4	21.7		18.5	17.9		13.8		8.7			4.6				110
115	37.7	36.6	34.1	31.6	30.6		22.4	21.6		18.5	17.8		13.7	12.8	8.7			4.5				115
120		36.7	34.5	31.6	30.5		22.4	21.6		18.5	17.8		13.7	12.7	8.7	7.8		4.5				120
125		36.6	35		30.5	28.5		21.6		17.8			13.7	12.6	8.7	7.8		4.5				125
130		36.6	34.4		30.5	28.1		21.6		17.8			12.5	12.5	7.7			4.5		3.6		130
135		36.6	32.9		30.4	27.4		21.6	21	17.8			12.5	12.5	7.6			3.6				135
140			31.4			26.7		21.6	20.9	17.8			12.4	12.4	7.6			3.6				140
145			30.1			26.1			20.7	17.8	16.8		12.4	12.4	7.5			3.5				145
150			28.8			25.6			20.6		16.4		12.4	12.4	7.5			3.5				150
155						25			20.2		16			11.6	7.5			3.5				155
160									19.9		15.6			11.6				3.5				160
165											15.3			11.3			6.9					165
170														11			7					170
175														10.7			7.1			3.1		175
180																	7.1			3.2		180
185																				3.3		185

\* adapter · pièce d'adaptateur

t\_240\_004\_50501\_00\_000

# Lifting capacities Forces de levage

TN



**Preliminary  
Préliminaire**

ft	48 + 11.5 ft*			64 + 11.5 ft*			80 + 11.5 ft*			96 + 11.5 ft*			112 + 11.5 ft*			ft
	115 ft			115 ft			115 ft			115 ft			115 ft			
	82°	75°	68°	82°	75°	68°	82°	75°	68°	82°	75°	68°	82°	75°	68°	
45	56.1															45
50	55.4			52.7					48.9							50
55	54.7			52.2					48.6			43.8				55
60	53.7			51.6					48.2			43.6			38.4	60
65	52.8	52.4		51.1					47.8			43.4			38.4	65
70	52	51.4		50.6	50				47.5			43.1			38.3	70
75	51.2	50.3		50	49.3				47.2	46.3		42.9			38.2	75
80	50.6	49.4		49.4	48.5				46.9	46.2		42.7	41.4		38.1	80
85	50.2	48.6	48.2	49.1	47.8				46.7	45.8		42.6	41.7		38	85
90	49.3	47.8	47.2	48.8	47.1				46.6	45.2		42.6	41.5		38	90
95	47.2	47.2	46.1	48.5	46.5	45.9			46.5	44.8		42.5	41.3		38	95
100	44.3	46.8	44.9	48.1	46.1	45.1			46.5	44.4	43.7	42.5	41.1		38	100
105	39.6	45.9	43.9	44.7	45.9	44.5			46.2	44.1	43.2	42.5	40.9	39.1	38	105
110	34.3	44.1	43.2	39.7	45.9	44			42.8	44	42.6	42.4	40.8	39.5	38	110
115	28.6	40	42.8	34.4	45.5	43.6			38.4	44	42.1	41.6	40.7	39.6	38	115
120		35	42.2	27.1	41.7	43.4			32.7	43.7	41.8	37.1	40.7	39.2	37.6	120
125			39.6		36.7	43.3				42	41.5		40.7	38.9	35.5	125
130			34.4			41.6				37.4	39.7		40.7	38.1	36.6	130
135						38.2					37.9		38.3	36.4	36.6	135
140											36.2			34.8	36.1	140
145														33.3		145
150														31.9		150
155															28.6	155

\* adapter · pièce d'adaptateur

t\_240\_004\_50601\_00\_000



**Preliminary  
Préliminaire**





ft	128 + 11.5 ft*			144 + 11.5 ft*			160 + 11.5 ft*			176 + 11.5 ft*			192 + 11.5 ft*			208 + 11.5 ft*			ft	
	115 ft			115 ft			115 ft			115 ft			115 ft			115 ft				
	82°	75°	68°	82°	75°	68°	82°	75°	68°	82°	75°	68°	82°	75°	68°	82°	75°	68°		
60	33.5																		60	
65	33.4			28					20.6										65	
70	33.4			28					20.5			16.8							70	
75	33.3			28					20.3			16.7			12.3				75	
80	33.3			28					20.2			16.6			12.2			7.5	80	
85	33.3			28					20.1			16.5			12			7.3	85	
90	33.2	31.6		28					20			16.5			11.9			7.3	90	
95	33.2	31.8		28					19.9			16.4			11.8			7.2	95	
100	33.2	32.1		28	26.6				19.8			16.4			11.7			7.1	100	
105	33.2	32.2		28	26.8				19.8	19.3		16.3			11.6			7	105	
110	33.2	32.2		28	27				19.8	19.2		16.3	15.9		11.5			6.9	110	
115	33.2	32.2		28	27.1				19.8	19.1		16.3	15.8		11.5			6.9	115	
120	33.2	32.2	29.8	28	27.2				19.8	19.1		16.3	15.7		11.4	10.6		6.9	120	
125	33.2	32.2	30.2	28	27.2				19.8	19		16.3	15.6		11.4	10.5		6.9	125	
130		32.2	30.6	28	27.2	25			19.8	19		16.3	15.5		11.4	10.4		6.9	130	
135		32.2	31		27.1	25.2				19		16.3	15.4		11.4	10.3		6.9	135	
140		32.2	30.9		27.1	25.2				19	18.5		15.4		11.4	10.3		6.9	140	
145		32.2	29.7		27.1	24.7				19	18.4		15.4		11.4	10.2		6.9	145	
150			28.5		27.1	24.1				19	18.3		15.4	14.6	11.4	10.2		6.9	150	
155			27.3			23.6				19	18.2		15.4	14.6	11.4	10.2		6.9	155	
160			26.2			23.2					18.2			14.5	11.4	10.2	9.6	6.9	160	
165						22.7					18.1			14.2	11.4	10.2	9.7	6.9	165	
170											17.9			13.9	11.4	10.2	9.8	6.9	170	
175											17.6			13.6	11.4	10.2	9.7	6.9	175	
180														13.3	11.4	10.2	9.6	6.9	180	
185															11.4	10.2	9.6	6.9	185	
190																11.4	10.2	9.3	6.9	190

\* adapter · pièce d'adaptateur

t\_240\_004\_50601\_00\_000

# Lifting capacities Forces de levage

TN





48-208 ft  126 ft   360°  211600 lbs  85%

**Preliminary**  
**Préliminaire**

ft	48 + 11.5 ft*			64 + 11.5 ft*			80 + 11.5 ft*			96 + 11.5 ft*			112 + 11.5 ft*			ft	
	126 ft			126 ft			126 ft			126 ft			126 ft				
	82°	75°	68°	82°	75°	68°	82°	75°	68°	82°	75°	68°	82°	75°	68°		
50	49.1															50	
55	48.5			46.3			43.1									55	
60	47.9			45.8			42.7				38.6			34		60	
65	47.3			45.4			42.4				38.4			34		65	
70	46.5			45			42.1				38.2			33.9		70	
75	45.8	45.4		44.5	43.9		41.8				38			33.8		75	
80	45.2	44.6		44.1	43.7		41.6	40.6			37.9			33.7		80	
85	44.6	43.8		43.7	43.1		41.4	40.7			37.7	36.5		33.6		85	
90	44.2	43		43.4	42.5		41.2	40.4			37.6	36.6		33.5	32.2	90	
95	43.8	42.4	42	43.1	41.9		41.1	40.1			37.5	36.6		33.5	32.4	95	
100	43.1	41.8	41.2	42.8	41.4	41.1	41	39.8			37.5	36.5		33.5	32.5	100	
105	42.1	41.4	40.4	41.9	40.9	40.4	40.7	39.4	38.4		37.5	36.3		33.5	32.5	105	
110	40	41.1	39.7	40.8	40.7	39.7	40.1	39.1	38.5		37.5	36.2		33.5	32.4	110	
115	36	40.7	39	38.4	40.5	39.2	39.2	39	38		37.5	36.1	34.6	33.5	32.4	115	
120	31.6	39.6	38.5	35.3	40	38.8	37.4	38.8	37.6		37.3	36.1	34.9	33.5	32.4	30.5	120
125	26.9	36.4	38.2	31.1	39.1	38.5	34.4	38.6	37.2		36.6	36	34.9	33.5	32.4	30.8	125
130		32.4	37.8	26.2	36.9	38.4	29.9	38.2	37		33.3	36	34.7	33.3	32.4	31.1	130
135		27	36.1		33.2	38.4		37	36.8		28.7	36	34.5	31.7	32.4	31.4	135
140			32.2		28	37.5		33.8	36			35.9	34.2		32.4	31.4	140
145						34.6			34.4			34	33		32.4	30.7	145
150						28.9			33			29.3	31.7		32.4	29.5	150
155									31				30.4			28.3	155
160													29.2			27.1	160
165																26.1	165

\* adapter - pièce d'adaptateur

t\_240\_004\_50701\_00\_000

48-208 ft  126 ft   360°  211600 lbs  85%

**Preliminary**  
**Préliminaire**

ft	128 + 11.5 ft*			144 + 11.5 ft*			160 + 11.5 ft*			176 + 11.5 ft*			192 + 11.5 ft*			208 + 11.5 ft*			ft
	126 ft			126 ft			126 ft			126 ft			126 ft			126 ft			
	82°	75°	68°	82°	75°	68°	82°	75°	68°	82°	75°	68°	82°	75°	68°	82°	75°	68°	
65	29.6																		65
70	29.6			24.7			18.2												70
75	29.6			24.7			18.1			14.8									75
80	29.5			24.7			18			14.7			10.3			5.8			80
85	29.4			24.6			17.9			14.6			10.1			5.8			85
90	29.4			24.6			17.8			14.6			10			5.7			90
95	29.4			24.6			17.7			14.5			9.9			5.6			95
100	29.3	28.1		24.6			17.7			14.4			9.8			5.5			100
105	29.3	28.3		24.6	23.4		17.6			14.4			9.7			5.4			105
110	29.3	28.4		24.6	23.5		17.5	17.1		14.3			9.6			5.4			110
115	29.3	28.5		24.6	23.7		17.5	16.9		14.3	13.5		9.5			5.3			115
120	29.3	28.5		24.6	23.9		17.5	16.8		14.2	13.4		9.5			5.3			120
125	29.3	28.5		24.6	23.9		17.5	16.8		14.2	13.3		9.5	8.6		5.2			125
130	29.3	28.5	26.5	24.6	24		17.5	16.8		14.2	13.2		9.4	8.6		5.2	4.4		130
135	29.3	28.4	26.8	24.6	24		17.5	16.8		14.2	13.1		9.4	8.5		5.2	4.4		135
140	29	28.4	27.2	24.6	24.1	22.1	17.5	16.8		14.2	13.1		9.4	8.4		5.2	4.3		140
145		28.4	27.5		24.1	22.4	17.5	16.8	16.4	14.2	13.1		9.4	8.4		5.2	4.3		145
150		28.4	27.7		24.1	22.4		16.8	16.3		13.1			8.4		5.2	4.2		150
155		28.4	26.9		24.1	22.2		16.8	16.2		13.1	12.3		8.4		4.2	4.2		155
160			25.9		24.1	21.8		16.8	16.1		13.1	12.5		8.4		4.2	4.2		160
165			24.8			21.4		16.8	16.1		13.1	12.6		8.4	7.9	4.2	4.2		165
170			23.9			21			16			12.6		8.4	8	4.2	4.2		170
175						20.7			16			12.5		8.4	8.1	4.2	3.9		175
180						20.1			16			12.4			8.2	4			180
185									15.9						8.3		4.2		185
190												11.9			8.3		4.3		190
195															8.1		4.3		195
200																	4.2		200

\* adapter - pièce d'adaptateur

t\_240\_004\_50701\_00\_000

# Lifting capacities Forces de levage

TN

		48 + 11.5 ft*			64 + 11.5 ft*			80 + 11.5 ft*			96 + 11.5 ft*			112 + 11.5 ft*				
		138 ft			138 ft			138 ft			138 ft			138 ft				
		82°	75°	68°	82°	75°	68°	82°	75°	68°	82°	75°	68°	82°	75°	68°		
55	ft	43.2			41												55	
60	ft	42.7			40.7			37.9									60	
65	ft	42.1			40.3			37.7			34.1			30.1			65	
70	ft	41.6			40			37.4			33.9			30			70	
75	ft	41			39.6			37.1			33.7			29.9			75	
80	ft	40.5	40.3		39.2	38.6		36.9			33.5			29.8			80	
85	ft	40	39.6		38.9	38.5		36.7	35.7		33.4			29.7			85	
90	ft	39.5	38.9		38.6	38.2		36.5	35.8		33.3	32.1		29.6			90	
95	ft	38.9	38.2		38.3	37.7		36.3	35.7		33.1	32.2		29.6	28.4		95	
100	ft	38	37.7	37.6	37.6	37.2		36.1	35.4		33	32.3		29.6	28.6		100	
105	ft	37.2	37.2	36.8	36.9	36.8	36.4	35.7	35.2		33	32.2		29.5	28.7		105	
110	ft	35.9	36.7	36.2	35.9	36.5	36	35.4	35	33.6	33	32.1		29.5	28.7		110	
115	ft	34.7	35.9	35.6	34.8	36	35.5	34.5	34.7	33.8	32.8	32		29.5	28.7		115	
120	ft	33.2	35	35.1	33.6	35.1	35	33.4	34.4	33.8	32.3	31.8	30.2	29.5	28.6		120	
125	ft	31.3	33.8	34.6	32.5	34.3	34.6	32.4	33.9	33.5	31.8	31.8	30.5	29.5	28.6	26.7	125	
130	ft	28.5	32.7	33.9	31.1	33.2	34.2	31.5	33.3	33.2	31.1	31.8	30.8	29.5	28.6	26.9	130	
135	ft	24.7	31.6	32.9	28	32.1	33.5	29.8	32.3	32.9	30.2	31.7	30.8	29.4	28.6	27.2	135	
140	ft	20.1	29.2	31.9	24.2	31.2	32.7	27.1	31.4	32.6	28.8	31.1	30.7	28.8	28.6	27.5	140	
145	ft		25.2	30.9		29.3	31.7		30.5	32.1	26.5	30.5	30.5	28	28.6	27.7	145	
150	ft			29		26	30.8		29.4	31.3		29.7	30.4	28.6	27.7		150	
155	ft					29.9		26.4	30.4			29.1	30	28.5	27.6		155	
160	ft					27.4			29.7			27	28.8	28.1	26.7		160	
165	ft								28.6					26.9	25.7		165	
170	ft													26.6	24.7		170	
175	ft														23.8		175	
180	ft														22.8		180	

\* adapter · pièce d'adaptateur

t\_240\_004\_50801\_00\_000

		128 + 11.5 ft*			144 + 11.5 ft*			160 + 11.5 ft*			176 + 11.5 ft*			192 + 11.5 ft*				
		138 ft			138 ft			138 ft			138 ft			138 ft				
		82°	75°	68°	82°	75°	68°	82°	75°	68°	82°	75°	68°	82°	75°	68°		
70	ft	26.1			21.9												70	
75	ft	26			21.9			15.9									75	
80	ft	25.9			21.8			15.9			12.8						80	
85	ft	25.9			21.8			15.8			12.7			8.3			85	
90	ft	25.8			21.8			15.7			12.6			8.2			90	
95	ft	25.8			21.8			15.7			12.5			8.1			95	
100	ft	25.8			21.8			15.6			12.3			7.9			100	
105	ft	25.8	24.7		21.8			15.6			12.2			7.9			105	
110	ft	25.7	24.8		21.8	20.7		15.5			12.1			7.8			110	
115	ft	25.7	24.9		21.8	20.8		15.4	15		12			7.7			115	
120	ft	25.7	25		21.8	21		15.4	14.9		11.9	11.3		7.6			120	
125	ft	25.7	25		21.8	21.1		15.4	14.8		11.9	11.2		7.6			125	
130	ft	25.7	25		21.8	21.2		15.4	14.7		11.9	11.1		7.5	6.8		130	
135	ft	25.7	25	23.1	21.8	21.2		15.4	14.7		11.9	11		7.5	6.7		135	
140	ft	25.7	24.9	23.3	21.8	21.3		15.4	14.6		11.9	10.9		7.5	6.7		140	
145	ft	25.3	24.9	23.6	21.8	21.2	19.4	15.4	14.6		11.9	10.9		7.5	6.6		145	
150	ft	24.9	24.9	23.9	21.8	21.2	19.6	15.4	14.6	14.2	11.9	10.9		7.5	6.6		150	
155	ft		24.9	24.2		21.2	19.9	15.4	14.6	14.2	11.9	10.9		7.5	6.6		155	
160	ft		24.9	24.3		21.2	20.1		14.6	14.1		10.9		7.5	6.6		160	
165	ft		24.9	24.3		21.2	20		14.6	14.1		10.9	10.5		6.6		165	
170	ft			23.8		21.2	19.7		14.6	14.1		10.9	10.7		6.6		170	
175	ft			22.9			19.4		14.6	14.1		10.9	10.8		6.6	6.4	175	
180	ft			22			19.1			14		10.9	10.9		6.6	6.5	180	
185	ft						18.8			14			10.9		6.6	6.6	185	
190	ft						18.3			14			10.8			6.7	190	
195	ft									14			10.7			6.7	195	
200	ft												10.5			6.6	200	
205	ft															6.6	205	

\* adapter · pièce d'adaptateur

t\_240\_004\_50801\_00\_000



# Lifting capacities Forces de levage

TN

48-192 ft  
149 ft  
360°  
211600 lbs  
85%

Preliminary  
Préliminaire

ft	48 + 11.5 ft*			64 + 11.5 ft*			80 + 11.5 ft*			96 + 11.5 ft*			112 + 11.5 ft*			ft
	149 ft			149 ft			149 ft			149 ft			149 ft			
	82°	75°	68°	82°	75°	68°	82°	75°	68°	82°	75°	68°	82°	75°	68°	
60	37.8			35.9			33.3			30.1						60
65	37.4			35.7			33.1			30			26.5			65
70	36.9			35.4			32.8			29.8			26.4			70
75	36.5			35.1			32.6			29.7			26.3			75
80	36.1			34.8			32.4			29.5			26.2			80
85	35.8	35.5		34.5	33.7		32.2	31.3		29.4			26.1			85
90	35.4	35.1		34.3	33.7		32.1	31.4		29.3	28.2		26			90
95	35	34.5		34	33.6		31.9	31.4		29.2	28.3		26	25		95
100	34.6	34		33.8	33.3		31.8	31.2		29.1	28.4		25.9	25.1		100
105	34.3	33.5	33.4	33.6	33		31.7	31.1		29	28.4		25.9	25.2		105
110	34.1	33.1	32.9	33.5	32.7	31.7	31.6	30.9		29	28.3		25.9	25.3		110
115	33.8	32.6	32.2	33.3	32.4	31.9	31.6	30.7		29	28.2		25.9	25.2		115
120	33.6	32.3	31.7	33.2	32.1	31.6	31.5	30.6	29.5	29	28.1	26.4	25.9	25.1		120
125	33.3	32.1	31.3	33	31.9	31.2	31.5	30.6	29.7	29	28		25.9	25.1		125
130	31.4	32	30.9	32.4	31.7	30.9	31.5	30.5	29.8	29	28	26.7	25.9	25.1		130
135	28.6	32	30.7	30.5	31.7	30.6	30.8	30.4	29.6	29	28	26.9	25.9	25.1	23.5	135
140	25.7	31.3	30.5	28.3	31.7	30.4	29.7	30.3	29.4	29	28	27.1	25.9	25.1	23.7	140
145	22.6	29.2	30.4	25.5	31.2	30.2	27.8	30.3	29.2	28.9	28	27.2	25.9	25.1	24	145
150	19.2	26.5	30.2	22.3	29.6	30.1	24.8	30.2	29	27	28	27.1	25.9	25.1	24.3	150
155		23.4	29.1		27.3	30.1	21.4	29.7	29	24.2	28	27.1	25.6	25.1	24.3	155
160		18.7	26.8		24	29.8		27.8	29		28	27	24.1	25.1	24.3	160
165			23.1			28.5		24.6	28.7		27.6	27		25.1	24.3	165
170						25.3			27.6		25.1	26.4		25.1	24.3	170
175									26.4			25.4		24.9	23.8	175
180												24.4			22.9	180
185												23.5			22	185
190															21.2	190

\* adapter · pièce d'adaptateur

t\_240\_004\_50901\_00\_000

48-192 ft  
149 ft  
360°  
211600 lbs  
85%

Preliminary  
Préliminaire

ft	128 + 11.5 ft*			144 + 11.5 ft*			160 + 11.5 ft*			176 + 11.5 ft*			192 + 11.5 ft*			ft
	149 ft			149 ft			149 ft			149 ft			149 ft			
	82°	75°	68°	82°	75°	68°	82°	75°	68°	82°	75°	68°	82°	75°	68°	
70	23.1															70
75	23.1			19.4												75
80	23			19.4			14.1									80
85	23			19.4			14			10.9			6.8			85
90	22.9			19.3			14			10.8			6.7			90
95	22.9			19.3			13.9			10.7			6.6			95
100	22.8			19.3			13.8			10.6			6.5			100
105	22.8			19.3			13.8			10.5			6.4			105
110	22.8	21.8		19.3			13.7			10.3			6.3			110
115	22.8	21.9		19.3	18.3		13.7			10.3			6.3			115
120	22.8	22.1		19.3	18.4		13.6	13.3		10.2			6.2			120
125	22.8	22.1		19.3	18.5		13.6	13.2		10.1	9.5		6.1			125
130	22.8	22.1		19.3	18.6		13.6	13.1		10.1	9.4		6.1			130
135	22.8	22.2		19.3	18.7		13.5	13		10	9.3		6.1	5.4		135
140	22.8	22.2	20.3	19.3	18.8		13.5	12.9		10	9.2		6	5.3		140
145	22.8	22.2	20.5	19.3	18.8		13.5	12.8		10	9.2		6	5.2		145
150	22.8	22.2	20.7	c19.3	18.8	17	13.5	12.8		10	9.2		6	5.2		150
155	22.8	22.3	21	19.3	18.8	17.2	13.5	12.8		10	9.2		6	5.2		155
160	22.8	22.3	21.2	19.3	18.8	17.4	13.5	12.8	12.5	10	9.2		6	5.2		160
165		22.3	21.4	19.3	18.7	17.7	13.5	12.8	12.5	10	9.2		6	5.2		165
170		22.3	21.6		18.7	17.8		12.8	12.4	10	9.2	8.9	6	5.2		170
175		22.3	21.7		18.7	17.9		12.8	12.4		9.2	9		5.2		175
180		22.3	21.7		18.7	17.8		12.8	12.4		9.2	9.2		5.2	5.1	180
185			21		18.7	17.6		12.8	12.3		9.2	9.3		5.2	5.2	185
190			20.2			17.3			12.3		9.2	9.3		5.2	5.3	190
195			19.4			17.1			12.3			9.2		5.2	5.3	195
200						16.7			12.3			9.2			5.4	200
205									12.3			9.2			5.3	205
210												9.2			5.3	210
215												9.1			5.3	215
220															5.3	220

\* adapter · pièce d'adaptateur

t\_240\_004\_50901\_00\_000

# Lifting capacities Forces de levage

TN

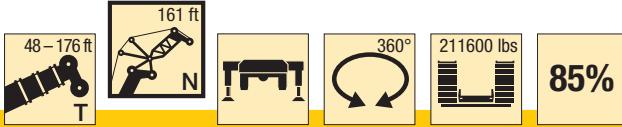

**Preliminary  
Préliminaire**

ft	48 + 11.5 ft*			64 + 11.5 ft*			80 + 11.5 ft*			96 + 11.5 ft*			112 + 11.5 ft*			128 + 11.5 ft*			144 + 11.5 ft*			160 + 11.5 ft*			176 + 11.5 ft*			ft
	161 ft			161 ft			161 ft			161 ft			161 ft			161 ft			161 ft			161 ft						
	82°	75°	68°	82°	75°	68°	82°	75°	68°	82°	75°	68°	82°	75°	68°	82°	75°	68°	82°	75°	68°	82°	75°	68°	82°	75°	68°	
65	33.3			31.7																							65	
70	33			31.5			29.4			26.5																		70
75	32.6			31.2			29.2			26.3			23.4			20.5												75
80	32.3			31			29			26.2			23.3			20.4			17.1									80
85	32			30.7			28.8			26.1			23.3			20.4			17.1			12.3			9.1			85
90	31.6	31.3		30.5	29.7		28.6			26			23.2			20.3			17.1			12.3			8.9			90
95	31.3	31.2		30.3	29.7		28.5	27.6		25.8			23.1			20.3			17			12.2			8.8			95
100	30.9	30.7		30	29.7		28.3	27.6		25.7	24.8		23			20.2			17			12.1			8.7			100
105	30.6	30.3		29.9	29.5		28.2	27.6		25.7	24.9		23	22.1		20.2			17			12.1			8.6			105
110	30.3	29.8	29.4	29.7	29.3		28.1	27.6		25.6	25		23	22.2		20.2			17			12.1			8.5			110
115	30.1	29.5	29.3	29.5	29.1		27.9	27.5		25.5	25		22.9	22.3		20.2	19.3		17			12			8.4			115
120	29.9	29.1	28.9	29.4	28.8	27.9	27.9	27.3		25.4	24.9		22.9	22.3		20.2	19.4		17	16.2		12			8.3			120
125	29.8	28.8	28.4	29.2	28.5	28	27.8	27.2	25.9	25.4	24.8		22.9	22.3		20.2	19.5		17	16.3		11.9	11.4		8.2			125
130	29.7	28.6	28	29	28.3	27.9	27.7	27	26	25.3	24.7	23.1	22.9	22.3		20.2	19.6		17	16.3		11.9	11.3		8.2	7.6		130
135	29.5	28.4	27.6	28.7	28.1	27.6	27.4	26.9	26.1	25.1	24.7	23.3	22.9	22.2		20.2	19.6		17	16.4		11.8	11.2		8.1	7.5		135
140	27.8	28.3	27.3	28.1	28	27.3	27.2	26.9	26.1	25	24.6	23.5	22.9	22.2	20.7	20.2	19.6		17	16.5		11.8	11.1		8.1	7.4		140
145	25.6	28.3	27.1	26.9	27.9	27.1	26.8	26.8	26.1	24.8	24.6	23.7	22.8	22.2	20.8	20.2	19.6	17.8	17	16.5		11.8	11.1		8.1	7.4		145
150	23.2	27.7	26.9	25.4	27.9	26.9	26.3	26.7	25.9	24.7	24.6	23.9	22.8	22.2	21.1	20.2	19.6	17.9	17	16.5		11.8	11.1		8.1	7.4		150
155	20.6	26.1	26.9	23	27.5	26.7	25.1	26.6	25.8	24.6	24.4	23.9	22.7	22.2	21.3	20.2	19.6	18.1	17	16.6	14.9	11.8	11.1		8.1	7.4		155
160	17.8	24	26.9	20.4	26.5	26.6	22.6	26.5	25.7	24	24.3	23.8	22.7	22.2	21.5	20.2	19.6	18.3	17	16.6	15	11.8	11.1		8.1	7.4		160
165		21.4	26.1	17.2	24.7	26.6	20	26.4	25.6	22.9	24.2	23.8	22.7	22.2	21.5	20.2	19.6	18.5	17	16.6	15.2	11.8	11.1	10.8	8.1	7.4		165
170		18	24.4		22.1	26.5		25.1	25.6	20.3	24.2	23.8	21.8	22.2	21.5	20.2	19.6	18.7	17	16.6	15.4	11.8	11.1	10.8	8.1	7.4		170
175			21.6			25.8		22.6	25.6		24.2	23.8		22.2	21.6		19.6	18.9	17	16.6	15.6	11.8	11.1	10.8	8.1	7.4	7.2	175
180						23.4		19	25.2		24	23.8		22.2	21.6		19.6	19		16.6	15.8		11.1	10.7	8.1	7.4	7.3	180
185									24.2			23.4		22.1	21.5		19.6	19		16.6	15.9		11.1	10.6		7.4	7.4	185
190									21.8			22.6			20.9		19.6	19		16.6	15.9		11.1	10.6		7.4	7.5	190
195												21.8			20.1			18.9		16.6	15.7		11.1	10.6		7.4	7.6	195
200															19.4			18.4			15.5		11.1	10.6		7.4	7.5	200
205																		17.7			15.4			10.6		7.4	7.5	205
210																					15.1			10.6			7.5	210
215																							10.6				7.5	215
220																							10.6				7.5	220
225																											7.5	225

\* adapter · pièce d'adaptateur

t\_240\_004\_51001\_00\_000

# Lifting capacities Forces de levage

TN

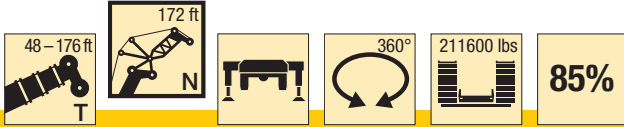

**Preliminary  
Préliminaire**

ft	48 + 11.5 ft*			64 + 11.5 ft*			80 + 11.5 ft*			96 + 11.5 ft*			112 + 11.5 ft*			128 + 11.5 ft*			144 + 11.5 ft*			160 + 11.5 ft*			176 + 11.5 ft*			ft	
	172 ft			172 ft			172 ft			172 ft			172 ft			172 ft			172 ft			172 ft			172 ft				
	82°	75°	68°	82°	75°	68°	82°	75°	68°	82°	75°	68°	82°	75°	68°	82°	75°	68°	82°	75°	68°	82°	75°	68°	82°	75°	68°		
65	29.8																										65		
70	29.5			28.1			26.1																					70	
75	29.2			27.9			25.9			23.5			20.8															75	
80	28.9			27.6			25.7			23.4			20.8			18.1												80	
85	28.6			27.4			25.6			23.3			20.7			18.1			15.1		10.7							85	
90	28.3			27.2			25.4			23.1			20.6			18			15.1		10.6			7.3				90	
95	28	27.6		27			25.2			23			20.6			18			15.1		10.6			7.1				95	
100	27.7	27.6		26.8	26.2		25.1	24.3		22.9			20.5			17.9			15.1		10.5			7				100	
105	27.5	27.3		26.6	26.3		25	24.3		22.8	22		20.4			17.9			15		10.5			6.9				105	
110	27.1	27		26.4	26.1		24.8	24.3		22.7	22		20.4	19.6		17.9			15		10.3			6.8				110	
115	26.8	26.6		26.3	26		24.7	24.3		22.7	22.1		20.3	19.7		17.9			15		10.2			6.8				115	
120	26.7	26.3	25.9	26.1	25.7		24.6	24.2		22.6	22.1		20.3	19.7		17.8	17.1		15		10.1			6.7				120	
125	26.5	26	25.8	25.9	25.5	24.5	24.3	24.1		22.5	22.1		20.3	19.8		17.8	17.2		15	14.2	10			6.6				125	
130	26.3	25.6	25.5	25.7	25.4	24.6	24.1	24	22.7	22.4	22		20.3	19.8		17.8	17.2		15	14.3	10	9.4		6.5				130	
135	26.1	25.4	25.1	25.4	25.2	24.8	23.9	23.8	22.8	22.3	22		20.3	19.7		17.8	17.3		15	14.3	9.9	9.4		6.5	5.7			135	
140	25.9	25.2	24.8	25.2	25	24.6	23.7	23.7	22.9	22.2	21.9	20.5	20.3	19.7		17.8	17.3		15	14.3	9.9	9.3		6.4	5.7			140	
145	25.6	25.1	24.5	25	24.9	24.4	23.4	23.5	23	22	21.8	20.6	20.2	19.7	18.1	17.8	17.3		15	14.3	9.9	9.2		6.4	5.7			145	
150	24.3	25	24.3	24.5	24.8	24.2	23.2	23.3	23	21.8	21.7	20.8	20.1	19.6	18.3	17.8	17.3		15	14.3	9.9	9.2		6.4	5.7			150	
155	22.8	25	24.1	23.7	24.6	24	23.1	23.1	22.9	21.7	21.6	21	20.1	19.6	18.4	17.8	17.3	15.7	15	14.3	9.9	9.2		6.4	5.8			155	
160	20.9	24.5	23.9	22.9	24.4	23.8	23	22.9	22.8	21.6	21.5	21.1	20	19.6	18.6	17.8	17.3	15.9	15	14.3	9.9	9.2		6.4	5.9			160	
165	18.7	23.3	23.9	20.8	24	23.7	22.4	22.7	22.7	21.5	21.4	21.1	19.9	19.6	18.8	17.8	17.3	16	15	14.3	13.1	9.9	9.2		6.4	6		165	
170	16.3	21.8	23.8	18.6	23.5	23.7	21	22.6	22.6	21.2	21.2	21.1	19.9	19.6	18.9	17.8	17.3	16.2	15	14.3	13.2	9.9	9.2	9.1		6.4	6.1		170
175		19.5	23.3	16.1	22.4	23.7	19.1	22.5	22.4	20.6	21.1	21	19.9	19.5	19	17.8	17.3	16.4	15	14.3	13.4	9.9	9.2	9.2		6.4	6.2		175
180		16.9	22.1		20.2	23.7		22.2	22.3	18.6	21.1	20.9	19.5	19.4	19	17.8	17.3	16.6	15	14.3	13.6	9.9	9.2	9.2		6.4	6.3	5.7	180
185			19.9		17.4	23.2		21.3	22.2		21.1	20.8		19.4	19	17.8	17.3	16.7	15	14.3	13.7	9.9	9.2	9.2		6.4	6.4	5.8	185
190			16.5			21.4		18.8	22.2		21.1	20.7		19.4	19		17.3	16.8		14.3	13.9	9.9	9.2	9.2		6.4	6.5	5.9	190
195						18.4			22.2			19	20.7		19.4	19		17.3	16.8		14.3	14.1		9.2	9.2		6.5	6	195
200									21.1				20.7		19.3	19		17.3	16.8		14.3	14.1		9.2	9.2		6.4	6.1	200
205												20			18.4			16.8		14.3	14.1		9.2	9.2		6.4	6.3	205	
210															17.7			16.7			14		9.2	9.2		6.4	6.4	210	
215																		16.2			13.9		9.2	9.2		6.4	6.5	215	
220																		15.6			13.7		9.2	9.2		6.4	6.5	220	
225																					13.2		9.2	9.2		6.4	6.5	225	
230																							9.2	9.2		6.4	6.5	230	
235																										6.4	6.5	235	

\* adapter · pièce d'adaptateur

t\_240\_004\_51101\_00\_000

# Lifting capacities Forces de levage

TN



**Preliminary  
Préliminaire**

ft	48 + 11.5 ft*			64 + 11.5 ft*			80 + 11.5 ft*			96 + 11.5 ft*			112 + 11.5 ft*			128 + 11.5 ft*			144 + 11.5 ft*			160 + 11.5 ft*			ft		
	184 ft			184 ft			184 ft			184 ft			184 ft			184 ft			184 ft								
	82°	75°	68°	82°	75°	68°	82°	75°	68°	82°	75°	68°	82°	75°	68°	82°	75°	68°	82°	75°	68°	82°	75°	68°			
70	26.1																							70			
75	25.9			24.7			23																	75			
80	25.6			24.5			22.9			20.8			18.4											80			
85	25.3			24.3			22.7			20.6			18.3											85			
90	25.1			24.1			22.6			20.5			18.3			15.9				13.2			8.9	90			
95	24.8			23.9			22.4			20.4			18.2			15.9				13.2			8.8	95			
100	24.6	24.1		23.7			22.3			20.3			18.1			15.8				13.2			8.7	100			
105	24.3	24.1		23.5	23		22.2	21.5		20.2			18.1			15.8				13.2			8.6	105			
110	24	24		23.3	23		22	21.5		20.1			18			15.8				13.1			8.5	110			
115	23.7	23.8		23	22.9		21.8	21.5		20.1	19.4		18	17.3		15.7				13.1			8.4	115			
120	23.4	23.5		22.7	22.8		21.7	21.5		20	19.5		17.9	17.3		15.7				13			8.3	120			
125	23.2	23.2	22.6	22.5	22.6		21.5	21.4		19.9	19.5		17.9	17.4		15.7	15			12.9			8.2	125			
130	22.9	22.9	22.6	22.2	22.4	21.4	21.3	21.3		19.8	19.5		17.9	17.4		15.7	15			12.9	12		8.2	130			
135	22.6	22.7	22.5	22	22.1	21.4	21	21.1		19.7	19.4		17.8	17.4		15.7	15.1			12.8	12		8.1	7.4	135		
140	22.3	22.4	22.2	21.7	21.8	21.5	20.8	20.9	19.9	19.5	19.4		17.8	17.4		15.7	15.1			12.7	12		8.1	7.4	140		
145	22.1	22.1	21.9	21.4	21.6	21.5	20.6	20.7	20	19.3	19.3	17.9	17.7	17.3		15.7	15.2			12.7	12		8.1	7.4	145		
150	21.8	21.9	21.7	21.2	21.3	21.4	20.4	20.5	20.1	19.1	19.1	18	17.7	17.3	15.8	15.7	15.2			12.7	12.1		8.1	7.5	150		
155	21.6	21.6	21.5	21	21.1	21.2	20.2	20.2	20.2	19	19	18.1	17.5	17.3	16	15.7	15.1			12.7	12.2		8.1	7.5	155		
160	21.2	21.5	21.3	20.8	20.8	21	20	20	20.1	18.8	18.9	18.3	17.4	17.2	16.1	15.7	15.1	13.7		12.7	12.3		8.1	7.6	160		
165	20.8	21.3	21.1	20.7	20.6	20.7	19.9	19.8	19.9	18.6	18.7	18.5	17.3	17.1	16.2	15.6	15.1	13.8		12.7	12.4		8.1	7.7	165		
170	19.7	21.1	21	20.6	20.5	20.5	19.8	19.7	19.7	18.5	18.5	18.5	17.2	17.1	16.4	15.6	15.1	13.9		12.7	12.6	11.3	8.1	7.8	170		
175	17.7	21	20.9	19.2	20.3	20.3	19.4	19.5	19.5	18.5	18.4	18.3	17.1	17	16.5	15.5	15.1	14.1		12.7	12.7	11.4	8.1	7.9	175		
180	15.6	20.4	20.8	17.6	20.3	20.2	18.6	19.4	19.4	18.4	18.2	18.2	17	16.9	16.6	15.5	15.1	14.2		12.7	12.7	11.6	8.1	8	7.5	180	
185	13	18.5	20.8	15.6	19.9	20	17.4	19.4	19.2	18.3	18.1	18.1	17	16.8	16.6	15.4	15.1	14.4		12.7	12.8	11.7	8.1	8	7.6	185	
190		16.2	20.4		19	20	15.2	19.3	19.1	17	18.1	18	17	16.7	16.6	15.4	15.1	14.6		12.7	12.8	11.9	8.1	8.1	7.7	190	
195			18.9		16.9	20		19.1	19.1		18.1	17.9	16	16.7	16.5	15.3	15.1	14.7		12.7	12.7	12	8.1	8.1	7.7	195	
200			16.5			19.7		17.3	19.1		18.1	17.8		16.7	16.5		15.1	14.8		12.7	12.2		8.1	8.1	7.7	200	
205						18			19.1		17.3	17.8		16.7	16.4		15.1	14.8		12.7	12.4		8.1	8.1	7.7	205	
210									18.8			17.8		16.7	16.4		15.1	14.8		12.7	12.5		8.1	7.8	7.8	210	
215												17.8			16.4		15.1	14.8		12.7	12.5		8.1	7.8	7.8	215	
220															16.1			14.9			12.4		8.1	7.8	7.8	220	
225															15.6			14.7			12.2			7.8	7.8	225	
230																		14.1			12.2				7.9	7.9	230
235																					11.8				7.9	7.9	235
240																									8	8	240

\* adapter · pièce d'adaptateur

t\_240\_004\_51201\_00\_000

# Lifting capacities Forces de levage

TN

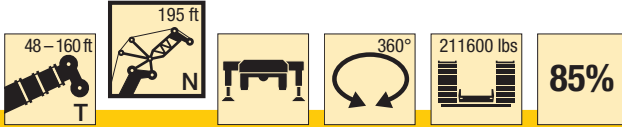

**Preliminary  
Préliminaire**

ft	48 + 11.5 ft*			64 + 11.5 ft*			80 + 11.5 ft*			96 + 11.5 ft*			112 + 11.5 ft*			128 + 11.5 ft*			144 + 11.5 ft*			160 + 11.5 ft*			ft
	195 ft			195 ft			195 ft			195 ft			195 ft			195 ft			195 ft						
	82°	75°	68°	82°	75°	68°	82°	75°	68°	82°	75°	68°	82°	75°	68°	82°	75°	68°	82°	75°	68°	82°	75°	68°	
75	22.9			21.8																				75	
80	22.6			21.6			20.2			18.3														80	
85	22.4			21.4			20.1			18.2			16.2											85	
90	22.2			21.3			19.9			18.1			16.1			14			11.5					90	
95	22			21.1			19.8			18			16.1			14			11.5			7.3		95	
100	21.8			20.9			19.7			17.9			16			13.9			11.6			7.2		100	
105	21.5	21.1		20.8			19.5			17.9			15.9			13.9			11.5			7.1		105	
110	21.3	21		20.6	20.1		19.4			17.8			15.9			13.9			11.4			7		110	
115	21	20.9		20.4	20.1		19.3	18.8		17.7			15.8			13.8			11.3			6.9		115	
120	20.7	20.8		20.1	20		19.1	18.8		17.6	17		15.8			13.8			11.2			6.8		120	
125	20.4	20.6		19.8	20		18.9	18.8		17.5	17.1		15.7	15.2		13.8			11.1			6.7		125	
130	20.1	20.2	19.6	19.5	19.7		18.7	18.8		17.4	17.1		15.7	15.2		13.7	13.1		11			6.6		130	
135	19.8	20	19.6	19.3	19.4		18.5	18.6		17.3	17.1		15.6	15.3		13.7	13.2		11	10.2		6.6		135	
140	19.6	19.7	19.6	19.1	19.2	18.7	18.3	18.4		17.2	17		15.6	15.3		13.7	13.2		10.9	10.2		6.6	6	140	
145	19.3	19.4	19.6	18.8	19	18.7	18.1	18.2	17.3	17	17		15.5	15.3		13.7	13.3		10.9	10.2		6.5	6	145	
150	19.1	19.2	19.3	18.6	18.7	18.7	17.9	18	17.4	16.8	16.9	15.6	15.5	15.2		13.7	13.3		10.9	10.3		6.5	6	150	
155	18.9	18.9	19.1	18.4	18.5	18.6	17.7	17.8	17.5	16.6	16.7	15.7	15.4	15.2		13.7	13.2		10.9	10.3		6.5	6	155	
160	18.7	18.7	18.9	18.2	18.3	18.4	17.5	17.6	17.5	16.5	16.6	15.7	15.3	15.1	13.9	13.7	13.2		10.9	10.4		6.5	6.1	160	
165	18.5	18.5	18.6	18	18.1	18.2	17.3	17.4	17.5	16.3	16.4	15.9	15.1	15.1	14	13.7	13.2	11.9	10.9	10.5		6.5	6.2	165	
170	18.4	18.3	18.4	17.8	17.9	18	17.1	17.2	17.3	16.2	16.3	16	15	15	14.1	13.6	13.2	12	10.9	10.6		6.5	6.3	170	
175	18.2	18.2	18.2	17.7	17.7	17.7	17	17	17.1	16.1	16.1	16.1	14.9	14.9	14.2	13.5	13.2	12.1	10.9	10.8	9.8	6.5	6.4	175	
180	17.5	18.1	18	17.6	17.6	17.6	16.9	16.9	16.9	16	15.9	16	14.8	14.7	14.3	13.5	13.2	12.2	10.9	10.9	9.9	6.5	6.5	180	
185	16	18	17.9	16.8	17.4	17.4	16.7	16.7	16.8	15.9	15.8	15.8	14.8	14.6	14.4	13.4	13.2	12.3	10.9	11	10	6.5	6.6	6.1	185
190	14.3	17.6	17.8	15.9	17.3	17.3	16.4	16.6	16.6	15.9	15.7	15.7	14.7	14.5	14.4	13.4	13.2	12.5	10.9	11	10.1	6.5	6.6	6.2	190
195	12.2	16.6	17.7	14.3	17.2	17.2	15.8	16.6	16.5	15.9	15.6	15.6	14.7	14.5	14.4	13.3	13.2	12.6	10.9	11.1	10.2	6.5	6.5	6.3	195
200		15	17.6		16.9	17.1	14.1	16.6	16.4	15.2	15.6	15.4	14.7	14.4	14.3	13.3	13.1	12.8	10.9	11.1	10.3	6.5	6.5	6.4	200
205		12.4	17.1		15.6	17.1		16.6	16.3		15.5	15.4	14.4	14.4	14.2	13.3	13.1	12.9	10.9	11.1	10.5	6.5	6.5	6.5	205
210			15.4			17.1		15.7	16.3		15.5	15.3		14.4	14.2		13.1	12.8	10.9	11	10.7	6.5	6.5	6.6	210
215						16.5			16.3		15.4	15.3		14.4	14.2		13.1	12.8		11	10.8		6.5	6.5	215
220									16.3			15.3		14.4	14.1		13.1	12.8		11	10.9		6.5	6.5	220
225									15.1			15.3			14.1		13.1	12.8		11	11		6.5	6.5	225
230												15.3			14.1		12.8		11	11		6.5	6.5	230	
235															14.1		12.8			11		6.5	6.5	235	
240																	12.8			10.9			6.5	240	
245																			10.7				6.5	245	
250																							6.5	250	
255																							6.5	255	

\* adapter · pièce d'adaptateur

t\_240\_004\_51301\_00\_000

# Lifting capacities Forces de levage

TN

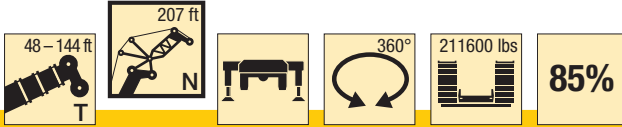

**Preliminary  
Préliminaire**

ft	48 + 11.5 ft*			64 + 11.5 ft*			80 + 11.5 ft*			96 + 11.5 ft*			112 + 11.5 ft*			128 + 11.5 ft*			144 + 11.5 ft*			ft		
	207 ft			207 ft			207 ft			207 ft			207 ft			207 ft			207 ft					
	82°	75°	68°	82°	75°	68°	82°	75°	68°	82°	75°	68°	82°	75°	68°	82°	75°	68°	82°	75°	68°			
80	20.2			19.2																		80		
85	20			19.1				17.8			16.1											85		
90	19.8			18.9				17.7			16			14.2			12.1					90		
95	19.6			18.7				17.5			15.9			14.1			12.1				9.8	95		
100	19.4			18.6				17.4			15.8			14.1			12.1				9.8	100		
105	19.1			18.4				17.3			15.8			14			12.1				9.7	105		
110	18.9	18.5		18.2				17.2			15.7			14			12.1				9.6	110		
115	18.6	18.4		18.1	17.7			17.1			15.6			13.9			12.1				9.4	115		
120	18.4	18.4		17.8	17.6			16.9	16.5		15.5			13.9			12				9.3	120		
125	18.1	18.2		17.6	17.6			16.7	16.5		15.4	14.9		13.8			12				9.3	125		
130	17.8	18		17.3	17.5			16.5	16.5		15.3	14.9		13.7	13.3		12				9.2	130		
135	17.5	17.7	17.1	17.1	17.3			16.3	16.5		15.2	15		13.7	13.3		11.9	11.3			9.2	135		
140	17.3	17.4	17.1	16.8	17			16.1	16.3		15.1	15		13.7	13.3		11.9	11.3			9.2	8.4	140	
145	17	17.2	17.1	16.6	16.8	16.2		15.9	16.1		15	14.9		13.6	13.3		11.9	11.4			9.2	8.4	145	
150	16.8	16.9	17.1	16.4	16.5	16.3		15.7	15.9	15.1	14.8	14.9		13.5	13.3		11.8	11.4			9.2	8.5	150	
155	16.6	16.7	16.9	16.1	16.3	16.3		15.5	15.7	15.1	14.6	14.7		13.4	13.2		11.8	11.4			9.2	8.5	155	
160	16.4	16.5	16.6	15.9	16	16.2		15.3	15.4	15.2	14.4	14.6	13.6	13.3	13.2		11.8	11.5			9.2	8.6	160	
165	16.2	16.2	16.4	15.7	15.8	16		15.1	15.2	15.2	14.2	14.4	13.7	13.2	13.1	12	11.8	11.5			9.2	8.7	165	
170	16	16	16.1	15.6	15.6	15.8		15	15.1	15.1	14.1	14.2	13.7	13	13	12.1	11.8	11.4			9.2	8.7	170	
175	15.8	15.8	15.9	15.4	15.4	15.6		14.8	14.9	15	14	14	13.8	12.9	12.9	12.2	11.7	11.4	10.3		9.2	8.8	175	
180	15.7	15.7	15.7	15.3	15.3	15.4		14.7	14.7	14.8	13.8	13.9	13.8	12.8	12.8	12.3	11.6	11.4	10.4		9.2	8.9	8.2	180
185	15.6	15.5	15.6	15.2	15.2	15.2		14.6	14.5	14.6	13.7	13.7	13.7	12.7	12.7	12.4	11.5	11.4	10.5		9.2	9.1	8.3	185
190	15.1	15.4	15.4	15	15	15		14.5	14.4	14.5	13.7	13.6	13.6	12.6	12.6	12.4	11.4	11.4	10.6		9.2	9.2	8.4	190
195	14	15.3	15.3	14.6	14.9	14.9		14.4	14.3	14.3	13.6	13.5	13.5	12.6	12.5	12.4	11.4	11.3	10.7		9.2	9.2	8.5	195
200	12.9	15.2	15.2	14.1	14.8	14.8		14.4	14.2	14.2	13.6	13.4	13.4	12.5	12.4	12.4	11.4	11.3	10.8		9.2	9.3	8.6	200
205	11.2	14.6	15.2	13	14.8	14.7		14.1	14.2	14.1	13.6	13.4	13.3	12.5	12.3	12.3	11.4	11.2	10.9		9.2	9.4	8.7	205
210		13.7	15.1	11.3	14.8	14.7		12.7	14.2	14	13.3	13.3	13.2	12.5	12.3	12.2	11.4	11.2	11		9.2	9.3	8.8	210
215		11.6	15.1		14.1	14.6			14.2	14	12.2	13.3	13.2	12.3	12.3	12.2	11.3	11.1	11		9.2	9.3	9	215
220			14.1			14.6			13.8	14		13.3	13.1		12.3	12.1	10.8	11.1	11		9.1	9.3	9.2	220
225						14.4			12.4	13.9		13.3	13.1		12.3	12.1		11.1	10.9			9.3	9.3	225
230										13.9			13.1		12.3	12		11.1	10.9			9.3	9.3	230
235										13.8			13.1			12		11.1	10.9			9.3	9.3	235
240													13.1			12			10.9			9.3	9.3	240
245																12			10.9				9.3	245
250																			10.9				9.3	250
255																							9.3	255
260																							9.2	260

\* adapter · pièce d'adaptateur

t\_240\_004\_51401\_00\_000

# Lifting capacities Forces de levage

TN



**Preliminary  
Préliminaire**

ft	48 + 11.5 ft*			64 + 11.5 ft*			80 + 11.5 ft*			96 + 11.5 ft*			112 + 11.5 ft*			128 + 11.5 ft*			144 + 11.5 ft*			ft
	218 ft			218 ft			218 ft			218 ft			218 ft			218 ft			218 ft			
	82°	75°	68°	82°	75°	68°	82°	75°	68°	82°	75°	68°	82°	75°	68°	82°	75°	68°	82°	75°	68°	
80	17.9																					80
85	17.8			17			15.7															85
90	17.7			16.9			15.7			14.2			12.3									90
95	17.5			16.7			15.6			14.1			12.3			10.4						95
100	17.3			16.6			15.5			14			12.3			10.4			8.1			100
105	17.2			16.4			15.4			14			12.2			10.4			8			105
110	16.9			16.3			15.3			13.9			12.2			10.4			7.9			110
115	16.7	16.4		16.1			15.2			13.8			12.2			10.4			7.8			115
120	16.4	16.3		15.9	15.6		15.1			13.7			12.2			10.4			7.6			120
125	16.2	16.2		15.7	15.6		15	14.5		13.6			12.1			10.4			7.6			125
130	16	16.1		15.5	15.5		14.8	14.5		13.6	13.1		12.1			10.3			7.5			130
135	15.7	15.8		15.3	15.4		14.6	14.5		13.5	13.1		12	11.5		10.3			7.4			135
140	15.4	15.6		15	15.2		14.4	14.5		13.3	13.1		12	11.5		10.3	9.8		7.4			140
145	15.2	15.4	15.1	14.8	15		14.2	14.4		13.2	13.1		12	11.6		10.3	9.9		7.4	6.8		145
150	15	15.1	15.1	14.6	14.7	14.2	14	14.2		13.1	13.1		11.9	11.6		10.3	9.9		7.4	6.8		150
155	14.8	14.9	15	14.4	14.5	14.3	13.8	14	13.2	13	13		11.9	11.5		10.3	9.9		7.4	6.9		155
160	14.6	14.7	14.8	14.2	14.3	14.3	13.6	13.8	13.2	12.8	12.9		11.7	11.5		10.2	9.9		7.4	7		160
165	14.4	14.5	14.6	14	14.1	14.2	13.4	13.6	13.3	12.6	12.7	11.9	11.6	11.5		10.2	9.9		7.4	7		165
170	14.2	14.3	14.4	13.8	13.9	14	13.2	13.3	13.3	12.4	12.6	11.9	11.5	11.4	10.4	10.2	9.9		7.4	7.1		170
175	14	14.1	14.2	13.7	13.7	13.8	13.1	13.1	13.2	12.3	12.4	12	11.3	11.3	10.5	10.2	9.9		7.4	7.2		175
180	13.8	13.9	14	13.5	13.5	13.6	13	13	13.1	12.2	12.2	12	11.2	11.2	10.6	10.1	9.9	8.8	7.4	7.3		180
185	13.7	13.7	13.8	13.3	13.4	13.4	12.8	12.8	13	12.1	12.1	12	11.2	11.2	10.6	10.1	9.9	8.8	7.4	7.3		185
190	13.6	13.6	13.6	13.2	13.2	13.3	12.7	12.7	12.8	11.9	12	12	11.1	11.1	10.7	10	9.9	8.9	7.4	7.4	7	190
195	13.6	13.5	13.5	13.1	13.1	13.1	12.6	12.6	12.7	11.9	11.9	11.9	11	11	10.8	9.9	9.8	9	7.4	7.5	7.1	195
200	13.2	13.4	13.4	13.1	13	13	12.5	12.5	12.5	11.8	11.8	11.8	10.9	10.9	10.8	9.9	9.8	9.1	7.4	7.6	7.2	200
205	12.4	13.3	13.3	12.8	12.9	12.9	12.5	12.4	12.4	11.8	11.7	11.7	10.9	10.8	10.8	9.8	9.7	9.3	7.4	7.6	7.3	205
210	11.5	13.2	13.2	12.5	12.9	12.8	12.5	12.3	12.3	11.7	11.6	11.6	10.9	10.7	10.7	9.8	9.7	9.4	7.4	7.5	7.3	210
215	10.2	12.8	13.1	11.7	12.8	12.7	12.4	12.3	12.2	11.7	11.5	11.5	10.9	10.6	10.6	9.8	9.6	9.4	7.4	7.5	7.4	215
220		12.4	13.1	10.3	12.8	12.7	11.5	12.2	12.1	11.6	11.5	11.4	10.8	10.6	10.6	9.7	9.6	9.5	7.4	7.5	7.5	220
225		10.6	13.1		12.5	12.6		12.2	12.1	11.1	11.5	11.4	10.5	10.6	10.5	9.5	9.6	9.5	7.4	7.5	7.5	225
230			12.7		11.2	12.6		12.2	12.1		11.5	11.3		10.6	10.4	9	9.6	9.4	7.4	7.5	7.6	230
235			10.7			12.6		11.4	12		11.5	11.3		10.6	10.4		9.6	9.4		7.5	7.5	235
240									12			11.3		10.6	10.4		9.6	9.3		7.5	7.5	240
245									12					10.6	10.3		9.6	9.3		7.5	7.5	245
250												11.3					9.3			7.5	7.5	250
255																	9.3				7.5	255
260																		9.3			7.5	260
265																			9.3		7.5	265
270																					7.5	270

\* adapter · pièce d'adaptateur

t\_240\_004\_51501\_00\_000

# Lifting capacities Forces de levage

TN



**Preliminary  
Préliminaire**

ft	48 + 11.5 ft*			64 + 11.5 ft*			80 + 11.5 ft*			96 + 11.5 ft*			112 + 11.5 ft*			128 + 11.5 ft*			144 + 11.5 ft*			ft
	230 ft			230 ft			230 ft			230 ft			230 ft			230 ft			230 ft			
	82°	75°	68°	82°	75°	68°	82°	75°	68°	82°	75°	68°	82°	75°	68°	82°	75°	68°	82°	75°	68°	
85	15.8																					85
90	15.6			14.9			13.7															90
95	15.5			14.7			13.7			12.2			10.5									95
100	15.3			14.6			13.6			12.1			10.5			8.8				6.5		100
105	15.2			14.5			13.5			12.1			10.4			8.8				6.4		105
110	14.9			14.3			13.4			12			10.4			8.8				6.2		110
115	14.7			14.2			13.3			12			10.4			8.7				6.1		115
120	14.5	14.2		14			13.2			11.9			10.4			8.7				6		120
125	14.2	14.2		13.8	13.5		13.1			11.9			10.3			8.7				5.9		125
130	14	14.1		13.6	13.5		13	12.6		11.8			10.3			8.7				5.9		130
135	13.8	13.9		13.4	13.4		12.8	12.6		11.7	11.3		10.3			8.6				5.9		135
140	13.5	13.7		13.2	13.3		12.6	12.6		11.6	11.2		10.3	9.9		8.6				5.8		140
145	13.3	13.4		12.9	13.1		12.4	12.5		11.5	11.2		10.2	9.9		8.6	8.2			5.8		145
150	13	13.2	13	12.7	12.9		12.2	12.4		11.4	11.2		10.2	9.9		8.6	8.2			5.8	5.3	150
155	12.8	13	13	12.5	12.7	12.3	12	12.2		11.2	11.2		10.2	9.9		8.6	8.3			5.8	5.3	155
160	12.5	12.7	12.9	12.2	12.4	12.3	11.8	12		11.1	11.1		10.1	9.9		8.6	8.3			5.8	5.4	160
165	12.2	12.4	12.7	12	12.2	12.3	11.6	11.8	11.3	10.9	11		10.1	9.9		8.6	8.4			5.8	5.4	165
170	12	12.2	12.4	11.7	12	12.2	11.4	11.6	11.4	10.8	10.9	10.1	9.9	9.8		8.6	8.4			5.8	5.5	170
175	11.7	11.9	12.2	11.5	11.7	12	11.2	11.4	11.4	10.6	10.8	10.2	9.8	9.7		8.6	8.4			5.8	5.5	175
180	11.5	11.7	11.9	11.3	11.5	11.8	11	11.2	11.4	10.4	10.6	10.2	9.6	9.6	8.8	8.6	8.4			5.8	5.6	180
185	11.3	11.5	11.7	11.1	11.3	11.5	10.8	11	11.2	10.3	10.4	10.2	9.5	9.5	8.9	8.5	8.4	7.3		5.8	5.7	185
190	11.1	11.3	11.4	10.9	11.1	11.3	10.6	10.8	11.1	10.1	10.3	10.2	9.4	9.4	9	8.4	8.4	7.4		5.8	5.7	190
195	11	11.1	11.2	10.7	10.9	11.1	10.4	10.6	10.9	9.9	10.1	10.2	9.3	9.3	9	8.4	8.3	7.4	5.8	5.8	5.5	195
200	10.9	10.9	11	10.6	10.7	10.9	10.3	10.4	10.7	9.8	9.9	10.1	9.1	9.2	9.1	8.3	8.3	7.5	5.8	5.9	5.6	200
205	10.7	10.8	10.9	10.5	10.6	10.7	10.2	10.3	10.5	9.7	9.8	9.9	9	9.1	9.1	8.2	8.2	7.6	5.8	6	5.7	205
210	10.5	10.6	10.7	10.4	10.4	10.5	10.1	10.1	10.3	9.6	9.7	9.8	9	9	9.1	8.2	8.2	7.7	5.8	6	5.8	210
215	10.3	10.5	10.6	10.3	10.3	10.4	10	10	10.1	9.5	9.5	9.7	8.9	8.9	9	8.1	8.1	7.8	5.8	6	5.8	215
220	10	10.4	10.4	10.3	10.2	10.2	9.9	9.9	10	9.5	9.4	9.6	8.8	8.8	8.9	8.1	8	7.8	5.8	6	5.9	220
225	9	10.4	10.4	10	10.1	10.1	9.9	9.8	9.9	9.4	9.3	9.4	8.8	8.7	8.8	8	8	7.8	5.8	6	6	225
230	7.7	10.4	10.3	9	10.1	10	9.5	9.7	9.7	9.4	9.3	9.3	8.8	8.7	8.7	7.9	7.9	7.8	5.8	6	6	230
235		9.4	10.3		10.1	10	8.7	9.7	9.7	9.4	9.2	9.2	8.6	8.6	8.6	7.8	7.9	7.8	5.8	6	6	235
240			10.3		9.6	10		9.7	9.6		9.2	9.1	8	8.6	8.6	7.3	7.9	7.8	5.8	6	6	240
245			9.7			10		9.7	9.6		9.2	9.1		8.6	8.5		7.8	7.7		6	6	245
250						10			9.6		9.2	9.1		8.6	8.4		7.8	7.7		6	6	250
255									9.6			9		8.6	8.4		7.8	7.7		6	6	255
260												9			8.4		7.8	7.7		6	6	260
265												9			8.4			7.6		6	6	265
270															8.4			7.6		6	6	270
275																		7.6		6	6	275
280																				6	6	280

\* adapter · pièce d'adaptateur

t\_240\_004\_51601\_00\_000



# Lifting heights Hauteurs de levage

TN

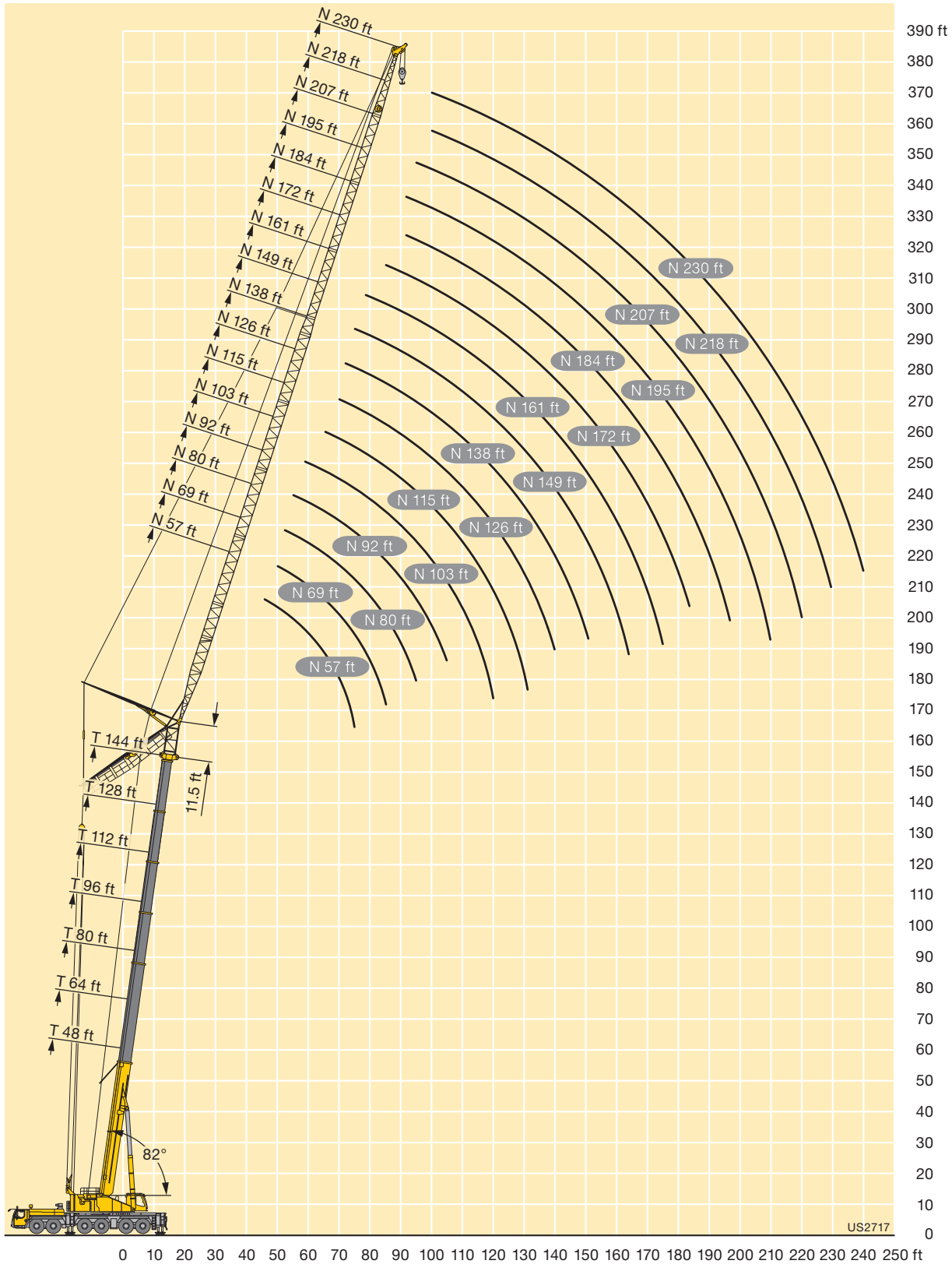

## Crane carrier

<b>Frame</b>	Self-manufactured, torsion-resistant box-type design of high-tensile fine grained structural steel.
<b>Outriggers</b>	4-point supporting system, hydraulically telescopic into horizontal and vertical direction. Operation with remote control, automatic support leveling, electronic inclination display.
<b>Engine</b>	8-cylinder Diesel, make Liebherr, watercooled, output 450 kW (612 h.p.), max. torque 2107 lbs-ft. Exhaust emissions acc. to 97/68/EG and EPA/CARB. Fuel reservoir: 211 gallons.
<b>Transmission</b>	Automatic transmission system with torque converter and intarder, make ZF, type TC-TRONIC with 12 forward speeds and 2 reverse speeds, transfer case with transfer differential.
<b>Axles</b>	Low maintenance carrier axles, all 6 axles steered. Axle 1, 3 and 5 are equipped with planetary gears, all driven axles with transverse differential locks, axle 3 with longitudinal differential lock.
<b>Cardan shaft</b>	All cardan shafts with 70° diagonal toothing and maintenance free.
<b>Suspension</b>	All axles are hydro-pneumatically suspended with automatic leveling. Suspension hydraulically lockable.
<b>Tyre equipment</b>	12 tyres, all axles equipped with single tyres. Size of tyres: 445/95 R 25 (16.00 R 25).
<b>Steering</b>	2-circuit system with hydraulic servo steering. Active speed depending rear axle steering, special steering programs for various driving situations.
<b>Brakes</b>	Service brake: all-wheel servo-air brake, all axles are equipped with disc brakes, dual circuit. Additional brakes: exhaust flap brake, Telma Eddy current brake (optional), intarder in gearbox. Hand brake: Spring-loaded, acting on all wheels of axles 2 to 6.
<b>Driver's cab</b>	Spacious corrosion resistant with comfort furnishings, mounted on rubber shock absorbers, safety glazing.
<b>Electrical system</b>	Modern data bus technique, 24 Volt DC, 2 batteries of 170 Ah each.

## Crane superstructure

<b>Frame</b>	Liebherr-manufactured, torsionally rigid steel construction made from high-tensile fine-grain steel. Triple-roller slewing rim.
<b>Crane drive</b>	Mechanical drive of the crane hydraulic from the chassis. Variable axial piston pumps with servo control and power regulation.
<b>Crane control</b>	Two self-centering control levers (joy-sticks). Pedal switches for telescoping. Infinitely variable crane motions through displacement control of the hydraulic pumps. Additional working speed control by variation of the Diesel engine speed.
<b>Hoist gear</b>	Axial piston variable displacement motor, hoist drum with integrated planetary gear and spring-loaded static brake. Actuation by closed regulated oil circuit.
<b>Luffing gear</b>	1 differential hydraulic ram with nonreturn valve.
<b>Slewing gear</b>	Axial piston fixed displacement motor, planetary gear, spring-loaded static brake. Actuation by closed regulated oil circuit.
<b>Crane cab</b>	Large screen area, compound glass, comfort furnishing, cabin tilttable 20° to rear.
<b>Safety devices</b>	LICCON2 safe load indicator, test system, hoist limit switches, safety valves against rupture of pipes and hoses.
<b>Counterweight</b>	123500 lbs
<b>Telescopic boom</b>	1 base section and 5 telescopic sections. All telescopic sections extendable individually by means of the rapid-cycle telescoping system TELEMATIK. Boom length 48 ft to 256 ft.

## Additional equipment

<b>Swing-away jib K/NZK</b>	41 ft – 115 ft long, mountable to the telescopic boom at 0°, 20° or 40°, integrated erection jib of 18 ft (option). Hydraulic ram for operating the swing-away jib from 0° – 40° (option).
<b>Lattice jibs F/N</b>	Fixed lattice jib 46 ft – 138 ft long, at 0°, 20°, 40° (F), luffing lattice jib 57 ft – 230 ft m long (N).
<b>Additional counterweight</b>	4 additional counterweight slabs of 22050 lbs each for a total counterweight of 211650 lbs.
<b>2nd hoist gear</b>	For 2-hook operation or for operating the luffing lattice jib.
<b>Tyre equipment</b>	12 tyres, size 525/80 R 25 (20.5 R 25).
<b>Drive 12 x 8</b>	The 4th axle is driven additionally.

Other items of equipment available on request.

## Châssis porteur

<b>Châssis</b>	Châssis résistant à la torsion de fabrication Liebherr, en acier à grains fins très résistant.
<b>Stabilisateurs</b>	Dispositif de calage horizontal et vertical en 4 points, entièrement déployable hydrauliquement. Utilisation avec commande à distance, mise à niveau automatique du calage, inclinomètre électronique.
<b>Moteur</b>	Moteur diesel, 8 cylindres, fabriqué par Liebherr, à refroidissement par eau, de 450 kW (612 ch), couple max. 2107 lbs-ft. Emissions des gaz d'échappement conformes aux directives 97/68/EG et EPA/CARB. Capacité du réservoir à carburant: 211 gallons.
<b>Boîte de vitesse</b>	Boîte automatique avec convertisseur de couple et ralentisseur, marque ZF, type TC-TRONIC avec 12 marches AV et 2 marches AR, boîte de transfert avec différentiel répartiteur.
<b>Essieux</b>	Essieux nécessitant peu d'entretien, les 6 essieux sont directeurs. Les essieux 1, 3 et 5 sont des essieux planétaires, tous les essieux moteurs avec différentiel transversal et l'essieu 3 avec différentiel longitudinal.
<b>Arbres articulés</b>	Tous les flasques de croisillons avec denture en croix 70° et sans entretien.
<b>Suspension</b>	Tous les essieux sont à suspension hydro-pneumatique avec mise à niveau automatique. Suspension blocable hydrauliquement.
<b>Pneumatiques</b>	12 roues à monte simple. Taille: 445/95 R 25 (16.00 R 25).
<b>Direction</b>	2 circuits avec direction assistée hydraulique. Direction active des essieux arrière et dépendante de la vitesse, programmes de direction spéciaux pour les différents modes de déplacement.
<b>Freins</b>	Freins de service: servofrein à air comprimé, tous les essieux sont munis de freins à disque, à 2 circuits. Freins auxiliaire : par clapet sur échappement, frein Telma (option), ralentisseur monté sur boîte de vitesse. Frein de secours et frein à main: par cylindres à ressorts sur les essieux 2 à 6.
<b>Cabine</b>	Spacieuse cabine, traitement anticorrosion, équipement «grand confort», suspension par silentblocs, vitrage de sécurité.
<b>Installation électrique</b>	Technique moderne de transmission de données par BUS de données, courant continu 24 Volts, 2 batteries de 170 Ah chacune.

## Partie tournante

<b>Châssis</b>	Fabrication Liebherr, construction soudée indéformable, en acier à grain fin haute résistance. Couronne d'orientation à triple rangée de rouleaux.
<b>Entraînement</b>	Entraînement mécanique de l'hydraulique de la grue par le châssis de la grue. Pompes réglables à pistons axiaux avec servocommande et réglage de puissance.
<b>Commande</b>	2 leviers à 4 directions avec rappel automatique au point mort. Commande des mouvements progressive en continu par variation de l'inclinaison des pompes et augmentation du régime moteur.
<b>Treuil</b>	Moteur hydraulique à cylindrée variable, treuil avec réducteur planétaire à frein d'arrêt à lamelles intégrées, en circuit hydraulique ferme.
<b>Relevage de flèche</b>	1 vérin hydraulique différentiel avec clapet anti-retour de sécurité.
<b>Orientation</b>	Moteur à cylindrée constante à pistons axiaux, engrenage planétaire, frein d'arrêt commandé par ressort en circuit hydraulique ferme.
<b>Cabine de grue</b>	Large champ de vision, vitrage de sécurité, équipement pour un confort idéal, cabine inclinable de 20° vers l'arrière.
<b>Sécurités</b>	Contrôleur de charge LICCON2, système test, fin de course crochet haut, clapets de sécurité en cas de ruptures de flexibles.
<b>Contrepoids</b>	123500 lbs
<b>Flèche télescopique</b>	Un élément de base et de 5 télescopes. Chaque partie peut être télescopée individuellement à l'aide du système de télescopage séquentiel rapide TELEMATIK. Longueur de flèche: 48 ft – 256 ft.

















## Équipement supplémentaire

<b>Flechette pliante K/NZK</b>	Longueur: 41 ft – 115 ft, montable sous un angle de 0°, 20° ou 40°, flechette de montage intégrée de 18 ft de long (en option). Verin hydraulique pour le relevage de la flechette pliante de 0° à 40° (en option).
<b>Flechettes F/N</b>	Flechette treillis fixe 46 ft – 138 ft long, sous 0°, 20°, 40° (F), flechette treillis à volée variable 57 ft – 230 ft long (N).
<b>Contrepoids complémentaire</b>	4 blocs latéraux de suspension de 22050 lbs pour un contrepoids total de 211650 lbs.
<b>Deuxième treuil</b>	Pour le travail avec 2 crochets ou le relevage de la flechette à volée variable.
<b>Pneumatiques</b>	12 pneus. Taille 525/80 R 25 (20.5 R 25).
<b>Entraînement 12 x 8</b>	Le 4ème essieu est également entraîné.





Autres équipements supplémentaires sur demande.

# Description of symbols Explication des symboles

## General symbols Symboles généraux

	Page Page		Driving speed Vitesse de translation
	Outriggers Calage		Driving speed – Onroad gear Vitesse de translation – Vitesse de route
	Axle Essieu		Transmission Boîte de vitesse
	Radius Portée		Gear Vitesse
	Boom length Longueur de la flèche		Hookblock / Capacity Moufle à crochet / Capacité de charge
	Boom position Position de la flèche		Hoist gear Treuil de levage
	Counterweight Contrepoids		Crane carrier Châssis porteur
	Tyres Pneumatiques		Crane superstructure Partie tournante de la grue
	Slewing gear / Working area Mécanisme d'orientation / Plage de travail		Gradability Aptitude à gravir les pentes
	Standard Norme		

## Crane specific symbols Symboles spécifiques à la grue

	Telescopic boom Flèche télescopique		Fixed lattice jib Fléchette treillis fixe
	Mechanical swing away jib Fléchette pliante mécanique		Luffing fly jib Fléchette treillis à volée variable
	Hydraulic swing away jib Fléchette pliante hydraulique		

## Remarks referring to load charts

1. The lifting capacities do not exceed 85 % of the tipping load according to ASME B 30.5.  
The crane's structural steelwork is in accordance with EN 13000 and ASME B 30.5.
2. For the calculation of the load charts at least a wind speed of 23 ft/s (7 m/s, 15.7 mph) and regarding the load a sail area of 1 m<sup>2</sup> per ton load and a wind resistance coefficient of 1.2 on the load have been taken into account. For lifting of loads with large sail areas and/or high wind resistance coefficients the maximum wind speed as stated in the load charts has to be reduced.
3. Lifting capacities are given in kips.
4. The weight of the hook blocks and hooks is part of the load and therefore it must be deducted from the lifting capacities.
5. Working radii are measured from the slewing centre.
6. The lifting capacities given for the telescopic boom apply if the folding jib is removed.
7. Subject to modification of lifting capacities.
8. Lifting capacities above 298600 lbs / 410000 lbs only with additional pulley block/special equipment.
9. The data of this brochure serves only for general information. All information is provided without warranty. Instructions for the correct commissioning of the crane please take from the operation manual and the load chart book.

## Remarques relatives aux tableaux des charges

1. La capacité de charge ne doit pas dépasser 85 % de la charge de basculement conformément à ASME B 30.5.  
La structure métallique de la grue est conforme à EN 13000 et ASME B 30.5.
2. Une vitesse de vent de 23 ft/s (7 m/s, 15.7 mph) minimum, une surface de prise au vent de 1 m<sup>2</sup> par tonne ainsi qu'un coefficient de résistance au vent de la charge 1,2 sont pris en compte pour le calcul des tableaux de charge. Lorsque des charges ayant une surface de prise au vent et/ou un coefficient de résistance au vent plus élevé(e)s sont levées, la vitesse de vent maximale indiquée dans les tableaux de charge doit être réduite.
3. Les charges sont indiquées en kips.
4. Le poids du crochet de levage resp. de la moufle à crochet est une partie de la charge et doit donc être déduit de la capacité de charge.
5. Les portées sont calculées à partir de l'axe de rotation.
6. Les charges indiquées pour la flèche télescopique sont valables lorsque la fléchette pliante est démontée.
7. Charges données sous réserve de modification.
8. Les charges supérieures à 298600 lbs / 410000 lbs seulement avec moufle additionnel/équipement supplémentaire.
9. Les données de cette brochure sont données à titre informatif. Ces renseignements sont sans garantie. Les consignes relatives à la bonne mise en service de la grue sont disponibles dans le manuel d'utilisation et le manuel de tableaux de charge.

Subject to modification / Sous réserve de modifications

Printed in Germany (1)

TD 240.00.US09.2013

**Liebherr-Werk Ehingen GmbH**

Postfach 1361, 89582 Ehingen, Germany

☎ +49 73 91 5 02-0, Fax +49 73 91 5 02-33 99

[www.liebherr.com](http://www.liebherr.com), E-mail: [info.lwe@liebherr.com](mailto:info.lwe@liebherr.com)

[www.facebook.com/LiebherrConstruction](https://www.facebook.com/LiebherrConstruction)

*Courtesy of Crane.Market*