

LTM 1400NX

リープヘル製
オールテレーンクレーン
吊上荷重400ton

Technical Data

メインブーム
70m

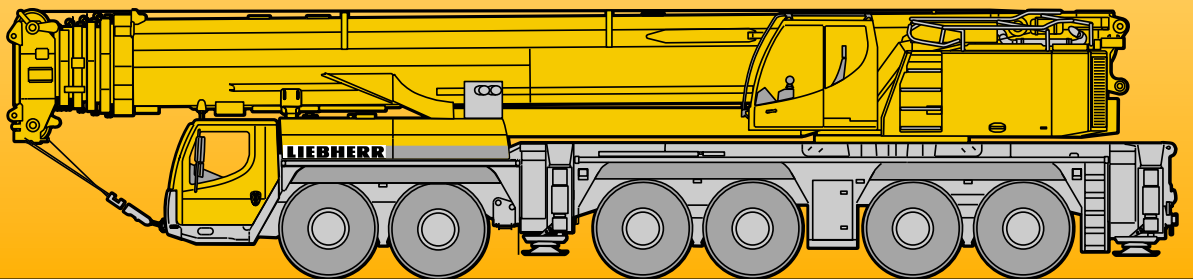

LIEBHERR

Courtesy of Crane.Market

クレーン部主仕様

| | | |
|--------------------|-------------|-------------|
| 吊上荷重 | 400ton×2.5m | |
| メインブーム長さ | 14.9～70m | |
| 補助ジブ | 固定式 | 6～42m |
| | 起伏式 | 12～78m |
| メインブーム段数 | 6段 | |
| カウンタウイト | 140/100ton | |
| 第1ウインチ | ラインプル | 12.4ton |
| | 巻上速度 | 0 - 120m/分 |
| | ワイヤー長さ/径 | 350m/23mm |
| 第2ウインチ | ラインプル | 12.4ton |
| | 巻上速度 | 0 - 120m/分 |
| | ワイヤー長さ/径 | 700m/23mm |
| 最大地上揚程 | メインブーム | 70m/14ton |
| | 補助ジブ | 102m/3.9ton |
| 巡回速度 | 0 - 1.2rpm | |
| 起伏速度 (84度まで) | 約75秒 | |
| ブーム伸縮速度 (14.9～70m) | 約533秒 | |

フック仕様

| 容量 (ton) | シーブ数 |
|----------|------|
| 200 | 9 |
| 160 | 7 |
| 125 | 5 |
| 80 | 3 |
| 37 | 1 |
| 12.5 | — |

フックはオプション設定
ですので左記の中からお
選びください。

エンジン仕様

| | |
|--------|-----------------|
| メーカー名 | リープヘル社製 |
| 型式 | D934LA6 ディーゼル |
| 冷却方式 | 水冷 |
| シリンダー数 | 4 |
| 出力 | 245HP 1800rpm |
| 最大トルク | 116kg-m 1500rpm |
| 燃料タンク | 400ℓ |

特徴

■ コントロール

ジョイスティックタイプの操作レバー（自動復帰式のユニバーサルコントロール）により電気式パイロットコントロールされます。

■ 油圧駆動装置

ウインチ回路には圧力補償付流量調整弁を有し、また、自動出力調整装置付油圧ポンプにより駆動されます。

■ 安全装置および指示計

LICCON（リーコン） 過負荷防止計が装備され、吊上げ総荷重、作業半径、ブーム長さ、揚程及びアウトリガ反力等がデジタルで表示されます。

過巻防止装置、ドラム回転計、過巻出し防止装置、油圧安全弁、油圧システム保護用安全バルブが装備されています。

キャビンが20度までチルトバックします。

本機は、公道を走行する場合、メインブームを別送として走行しなければなりません。



キャリア部主仕様

| | |
|---------------|-----------|
| 軸数 | 6 |
| 最高速度 | 80km/h |
| 総輪数 | 12 |
| 定員 | 2名 |
| タイヤ | 16.00 R25 |
| 登坂能力* (低速切換時) | 約26.9° |
| 最小回転半径 | 11.98m |

*登坂時の路面状況により、能力も多少異なります。

エンジン仕様

| | |
|--------|--------------------|
| メーカー名 | リープヘル社製 |
| 型式 | D9508A7 ディーゼル・エンジン |
| 冷却方式 | 水冷 |
| シリンダー数 | 8 |
| 出力 | 612HP 1900rpm |
| 最大トルク | 291kg-m 1500rpm |
| 燃料タンク | 約550 ℓ |

特徴

■ トランスミッション

ZF製で、トルクコンバーター及びインターダーを内蔵しております。前進12段、後進2段となっており、「TC-TRONIC」自動制御システムを採用しています。

■ サスペンション

全軸ハイドロニューマチックサスペンションであり、自動水平復帰機能（ニポー）を有しています。状況に応じて車高を上下に調整可能です。全軸油圧サスペンションをロックすることが可能です。

■ ステアリング

油圧源として1つは通常時、エンジンで駆動され、もう1つは非常用として駆動軸により駆動されます。



■ 常用ブレーキ

2回路式サーボブレーキが全軸に装備されています。また、エディカレント式電磁ブレーキ（オプション）を装備しています。

■ パーキング用ブレーキ

スプリング作動のブレーキが第2～6軸に作動します。

走行速度

| | 1 | 2 | 3 | 4 | 5 | 6 | 7 | 8 | 9 | 10 | 11 | 12 | R ₁ | R ₂ | |
|---|--------|-----|------|------|------|------|------|------|------|----|------|----|----------------|----------------|---|
|  | 245-62 | 7.9 | 10.3 | 13.1 | 16.7 | 21.4 | 28.2 | 36.2 | 46.8 | 60 | 76.1 | 80 | 264-67 | 8.6 |  |
| (km/h) | | | | | | | | | | | | | | | 50.9% |

走行軌跡図

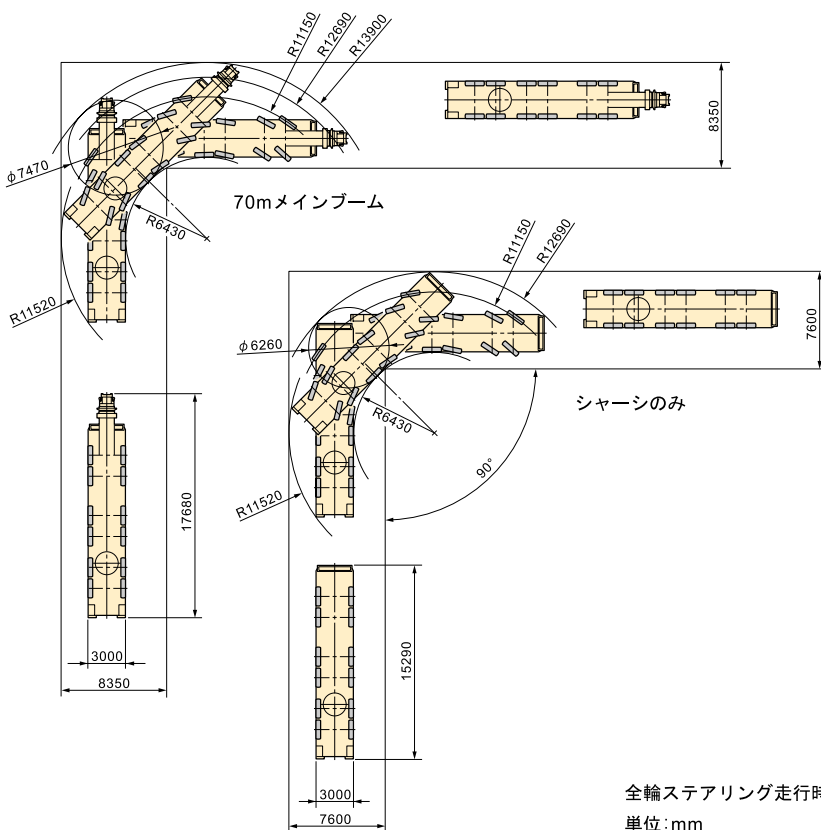

駆動部

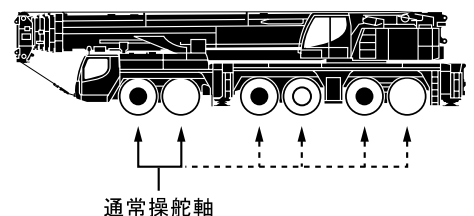

● 駆動軸：常時駆動します。

○：追加駆動軸

第3～6軸は第1～2軸と独立して操舵可能。（リアステアリング操作）

30km/h以下：1、2軸及び3～6軸が電氣的に操舵。

30km/h以上：3、4軸が直進に固定。
60km/h以上：さらに5、6軸が直進に固定。

ただし、状況により1～3軸が同方向、4～6軸が反対方向に操舵も可能。

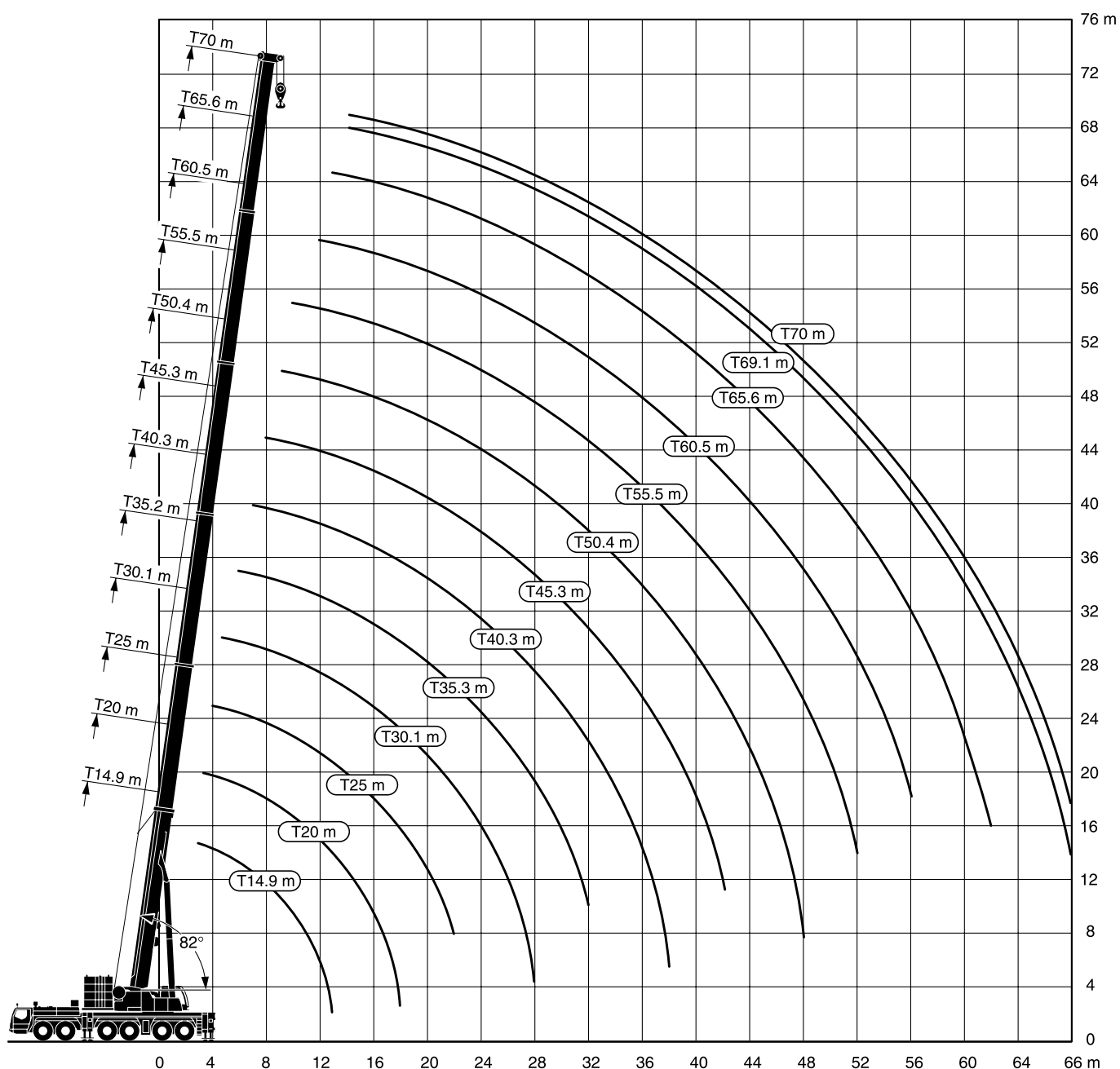

注意

- 1 定格総荷重はフックブロック、玉掛ワイヤー等の自重を含みます。
また、下記の条件が考慮されていないのでクレーンの操作には充分気をつけてください。
 - ① 地盤の強度、地震による影響
 - ② 作業速度に応じた動荷重および台風または強風による影響等
- 2 本機は水平に設置して、クレーン作業を行ってください。
- 3 作業半径は、クレーンの旋回中心から荷重の重心までの水平距離です。
- 4 メインブームの定格総荷重は補助ジブを取り除いた状態での値です。
- 5 メインブーム70m仕様で200トンを超える定格総荷重の場合は、特殊吊装置が必要です。

メインブーム定格総荷重表 T

LTM 1400NX



14.9m-70m

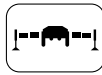

8.9m×8.53m

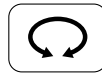

360°

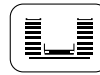

140t

| 作業半径(m) | メインブーム長さ | * 14.9m | 20m | 25m | 30.1m | 35.2m | 40.3m | 45.3m | 50.4m | 55.5m | 60.5m | 65.6m | 69.1m | 70m |
|---------|----------|---------|-------|-------|-------|-------|-------|-------|-------|-------|-------|-------|-------|------|
| 2.5 | 400.0 | | | | | | | | | | | | | |
| 3 | 350.0 | | | | | | | | | | | | | |
| 3.5 | 210.1 | | | | | | | | | | | | | |
| 4 | 198.0 | | | | | | | | | | | | | |
| 4.5 | 182.0 | | | | | | | | | | | | | |
| 5 | 170.0 | | | | | | | | | | | | | |
| 6 | 152.6 | 141.5 | 141.5 | | | | | | | | | | | |
| 7 | 132.0 | 126.3 | 127.1 | 121.1 | 110.8 | 80.1 | | | | | | | | |
| 8 | 115.2 | 113.8 | 114.6 | 111.3 | 105.7 | 90.3 | 66.1 | | | | | | | |
| 9 | 102.0 | 103.4 | 104.3 | 103.1 | 97.5 | 88.9 | 70.8 | 54.5 | 43.2 | | | | | |
| 10 | 91.3 | 94.7 | 95.4 | 94.7 | 90.8 | 86.9 | 70.8 | 52.2 | 42.4 | 33.9 | | | | |
| 11 | 82.4 | 87.1 | 87.9 | 87.1 | 85.1 | 82.0 | 70.1 | 49.7 | 41.1 | 33.5 | | | | |
| 12 | 75.0 | 79.7 | 81.3 | 80.5 | 79.8 | 77.2 | 68.1 | 47.0 | 39.4 | 32.9 | 27.3 | | | |
| 13 | 51.8 | 51.8 | 75.7 | 74.8 | 74.4 | 72.9 | 65.6 | 44.6 | 37.7 | 31.8 | 26.9 | 21.9 | | |
| 14 | | | 70.6 | 69.7 | 69.3 | 68.9 | 62.6 | 42.2 | 36.0 | 30.7 | 26.3 | 21.7 | 18.3 | 17.7 |
| 16 | | | 61.6 | 61.2 | 60.7 | 61.5 | 56.6 | 38.0 | 32.9 | 28.3 | 24.7 | 21.1 | 17.7 | 17.2 |
| 18 | | | 36.7 | 53.8 | 53.7 | 54.1 | 51.6 | 34.0 | 30.1 | 26.1 | 23.0 | 20.1 | 16.8 | 16.5 |
| 20 | | | | 47.6 | 48.4 | 47.8 | 47.2 | 31.5 | 27.4 | 24.2 | 21.4 | 19.1 | 15.9 | 15.6 |
| 22 | | | | 38.4 | 43.3 | 42.7 | 43.4 | 29.2 | 25.0 | 22.3 | 20.0 | 18.0 | 15.0 | 14.8 |
| 24 | | | | | 39.1 | 38.4 | 39.3 | 27.5 | 22.9 | 20.6 | 18.6 | 16.9 | 14.1 | 14.0 |
| 26 | | | | | 33.5 | 34.7 | 35.6 | 25.8 | 21.0 | 19.1 | 17.3 | 15.9 | 13.3 | 13.2 |
| 28 | | | | | 21.5 | 31.6 | 32.5 | 24.3 | 19.4 | 17.6 | 16.1 | 14.9 | 12.6 | 12.5 |
| 30 | | | | | | 29.1 | 29.8 | 23.1 | 17.9 | 16.3 | 15.0 | 13.9 | 11.8 | 11.7 |
| 32 | | | | | | 23.0 | 27.4 | 21.9 | 17.0 | 15.1 | 14.0 | 13.1 | 11.1 | 11.0 |
| 34 | | | | | | | 25.1 | 20.9 | 16.1 | 14.0 | 13.0 | 12.2 | 10.5 | 10.4 |
| 36 | | | | | | | 20.7 | 20.0 | 15.3 | 13.1 | 12.1 | 11.5 | 9.8 | 9.7 |
| 38 | | | | | | | 14.0 | 19.2 | 14.6 | 12.3 | 11.3 | 10.8 | 9.2 | 9.1 |
| 40 | | | | | | | | 18.5 | 13.8 | 11.6 | 10.7 | 10.1 | 8.7 | 8.5 |
| 42 | | | | | | | | 14.7 | 13.2 | 11.1 | 10.1 | 9.5 | 8.2 | 7.9 |
| 44 | | | | | | | | | 12.7 | 10.5 | 9.5 | 8.9 | 7.7 | 7.4 |
| 46 | | | | | | | | | 12.2 | 10.1 | 9.0 | 8.3 | 7.3 | 6.9 |
| 48 | | | | | | | | | 8.9 | 9.6 | 8.5 | 7.8 | 6.9 | 6.5 |
| 50 | | | | | | | | | | 9.3 | 8.1 | 7.3 | 6.5 | 6.0 |
| 52 | | | | | | | | | | 8.9 | 7.7 | 6.9 | 6.1 | 5.6 |
| 54 | | | | | | | | | | | 7.3 | 6.4 | 5.8 | 5.2 |
| 56 | | | | | | | | | | | 7.0 | 6.0 | 5.5 | 4.9 |
| 58 | | | | | | | | | | | 5.6 | 5.7 | 5.2 | 4.5 |
| 60 | | | | | | | | | | | | 5.3 | 4.9 | 4.2 |
| 62 | | | | | | | | | | | | 4.9 | 4.7 | 3.9 |
| 64 | | | | | | | | | | | | | 4.4 | 3.7 |
| 66 | | | | | | | | | | | | | 4.1 | 3.4 |

*後方吊、カウンターウエイト100t

50301

メインブーム定格総荷重表 T

LTM 1400NX

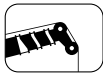

14.9m—70m

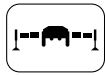

8.9m×8.53m

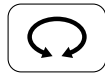

360°

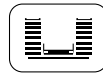

100t

| メインブーム 長さ 作業半径(m) | 14.9m | 20m | 25m | 30.1m | 35.2m | 40.3m | 45.3m | 50.4m | 55.5m | 60.5m | 65.6m | 69.1m | 70m | |
|-------------------------|-------|-------|-------|-------|-------|-------|-------|-------|-------|-------|-------|-------|------|-----|
| 3 | 155.7 | | | | | | | | | | | | | |
| 3.5 | 155.7 | 155.7 | | | | | | | | | | | | |
| 4 | 155.7 | 155.7 | 155.2 | | | | | | | | | | | |
| 4.5 | 155.7 | 155.7 | 154.8 | 114.6 | | | | | | | | | | |
| 5 | 155.1 | 154.7 | 146.8 | 114.6 | | | | | | | | | | |
| 6 | 137.2 | 137.9 | 133.3 | 114.6 | 93.0 | | | | | | | | | |
| 7 | 122.4 | 123.2 | 121.1 | 111.2 | 91.6 | 70.8 | | | | | | | | |
| 8 | 110.2 | 111.1 | 110.3 | 105.7 | 90.3 | 70.8 | 55.7 | | | | | | | |
| 9 | 100.2 | 101.0 | 100.3 | 97.5 | 88.9 | 70.8 | 54.5 | 43.2 | | | | | | |
| 10 | 91.3 | 92.2 | 91.2 | 90.2 | 86.9 | 70.8 | 52.2 | 42.4 | 33.9 | | | | | |
| 11 | 82.4 | 83.3 | 82.5 | 82.2 | 82.0 | 70.1 | 49.7 | 41.1 | 33.5 | | | | | |
| 12 | 75.0 | 75.9 | 75.1 | 75.8 | 75.6 | 68.1 | 47.0 | 39.4 | 32.9 | 27.3 | | | | |
| 13 | 51.8 | 69.7 | 68.8 | 69.8 | 69.2 | 65.6 | 44.6 | 37.7 | 31.8 | 26.9 | 21.9 | | | |
| 14 | | 64.2 | 64.3 | 64.3 | 63.7 | 62.6 | 42.2 | 36.0 | 30.7 | 26.3 | 21.7 | 18.3 | 17.7 | |
| 16 | | 55.2 | 55.5 | 55.3 | 54.7 | 55.7 | 38.0 | 32.9 | 28.3 | 24.7 | 21.1 | 17.7 | 17.2 | |
| 18 | | 36.7 | 48.5 | 48.3 | 47.7 | 48.7 | 34.0 | 30.1 | 26.1 | 23.0 | 20.1 | 16.8 | 16.5 | |
| 20 | | | 42.9 | 42.7 | 42.9 | 43.0 | 31.5 | 27.4 | 24.2 | 21.4 | 19.1 | 15.9 | 15.6 | |
| 22 | | | 37.9 | 38.0 | 39.0 | 38.3 | 29.2 | 25.0 | 22.3 | 20.0 | 18.0 | 15.0 | 14.8 | |
| 24 | | | | 33.8 | 34.9 | 34.1 | 27.5 | 22.9 | 20.6 | 18.6 | 16.9 | 14.1 | 14.0 | |
| 26 | | | | 31.3 | 31.2 | 30.4 | 25.8 | 21.0 | 19.1 | 17.3 | 15.9 | 13.3 | 13.2 | |
| 28 | | | | 21.5 | 28.1 | 27.3 | 24.3 | 19.4 | 17.6 | 16.1 | 14.9 | 12.6 | 12.5 | |
| 30 | | | | | 25.5 | 24.7 | 23.1 | 17.9 | 16.3 | 15.0 | 13.9 | 11.8 | 11.7 | |
| 32 | | | | | 22.5 | 22.4 | 21.9 | 17.0 | 15.1 | 14.0 | 13.1 | 11.1 | 11.0 | |
| 34 | | | | | | 20.4 | 20.8 | 16.1 | 14.0 | 13.0 | 12.2 | 10.5 | 10.4 | |
| 36 | | | | | | | 18.7 | 19.4 | 15.3 | 13.1 | 12.1 | 11.5 | 9.8 | 9.7 |
| 38 | | | | | | | 14.0 | 17.8 | 14.6 | 12.3 | 11.3 | 10.8 | 9.2 | 9.1 |
| 40 | | | | | | | | 16.4 | 13.8 | 11.6 | 10.7 | 10.1 | 8.7 | 8.5 |
| 42 | | | | | | | | | 14.6 | 13.2 | 11.1 | 10.1 | 9.5 | 7.9 |
| 44 | | | | | | | | | | 12.7 | 10.5 | 9.5 | 8.9 | 7.4 |
| 46 | | | | | | | | | | 12.2 | 10.1 | 9.0 | 8.3 | 6.9 |
| 48 | | | | | | | | | | 8.9 | 9.6 | 8.5 | 7.8 | 6.5 |
| 50 | | | | | | | | | | | 9.3 | 8.1 | 7.3 | 6.0 |
| 52 | | | | | | | | | | | 8.9 | 7.7 | 6.9 | 5.6 |
| 54 | | | | | | | | | | | | 7.3 | 6.4 | 5.2 |
| 56 | | | | | | | | | | | | 7.0 | 6.0 | 4.9 |
| 58 | | | | | | | | | | | | 5.6 | 5.7 | 4.5 |
| 60 | | | | | | | | | | | | | 5.3 | 4.2 |
| 62 | | | | | | | | | | | | | 4.9 | 3.9 |
| 64 | | | | | | | | | | | | | | 4.4 |
| 66 | | | | | | | | | | | | | | 4.1 |

50305

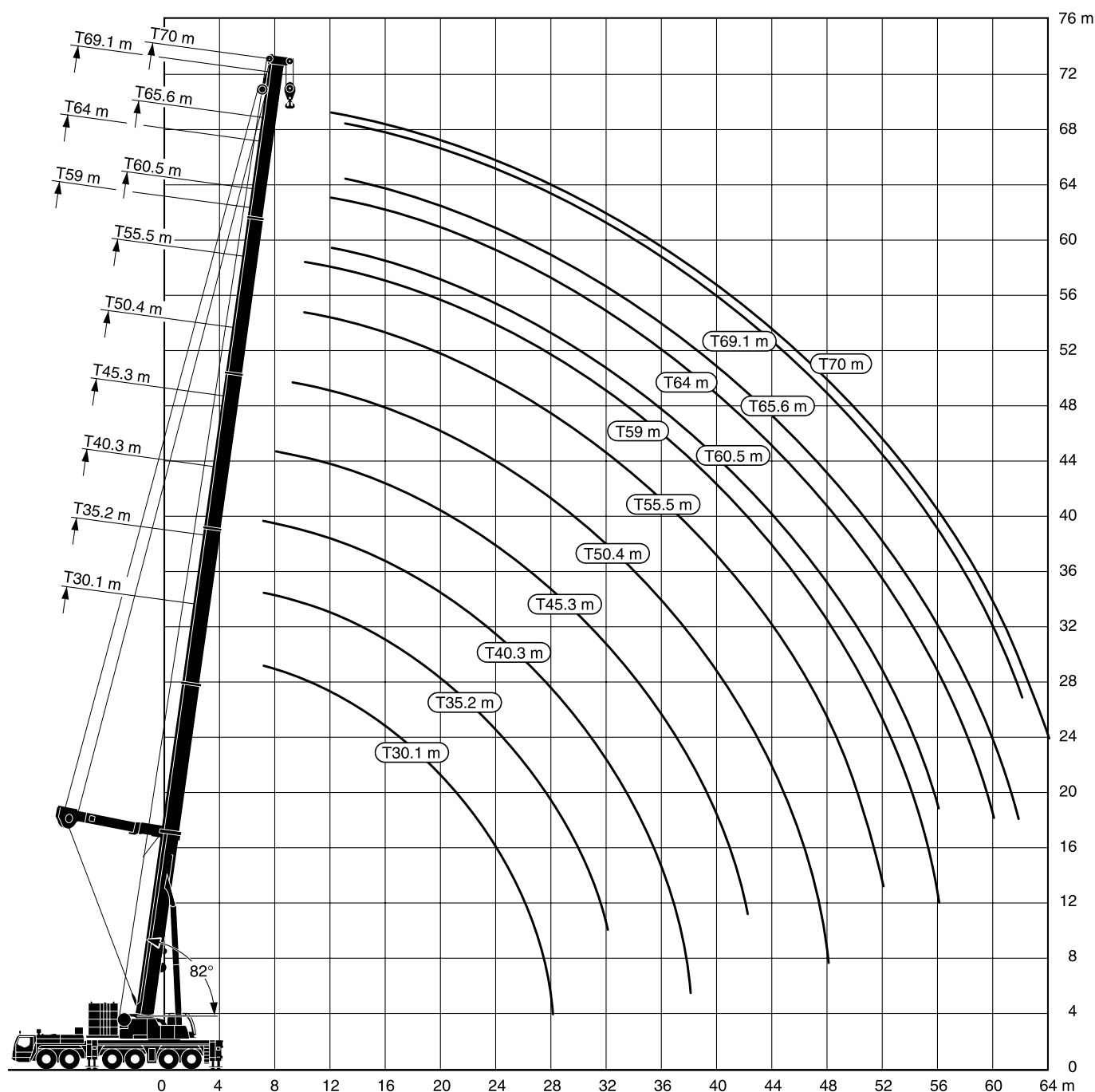

注意

- 1 定格総荷重はフックブロック、玉掛ワイヤー等の自重を含みます。
また、下記の条件が考慮されていませんのでクレーンの操作には充分気をつけてください。
 - ① 地盤の強度、地震による影響
 - ② 作業速度に応じた動荷重および台風または強風による影響等
- 2 本機は水平に設置して、クレーン作業を行ってください。
- 3 作業半径は、クレーンの旋回中心から荷重の重心までの水平距離です。
- 4 メインブームの定格総荷重は補助ジブを取り除いた状態での値です。
- 5 メインブーム70m仕様で200トンを超える定格総荷重の場合は、特殊吊装置が必要です。

メインブーム(ガイ仕様) 定格総荷重表 TY

LTM 1400NX

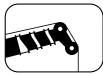

30.1m-70m

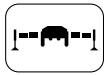

8.9m×8.53m

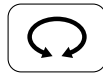

360°

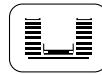

140t



| メインブーム 長さ 作業半径(m) | 30.1m | 35.2m | 40.3m | 45.3m | 50.4m | 55.5m | 59m | 60.5m | 64m | 65.6m | 69.1m | 70m |
|-------------------------|-------|-------|-------|-------|-------|-------|------|-------|------|-------|-------|------|
| 8 | 106.8 | 98.5 | | | | | | | | | | |
| 9 | 99.6 | 94.9 | 84.6 | | | | | | | | | |
| 10 | 92.4 | 89.2 | 83.2 | 75.5 | | | | | | | | |
| 11 | 87.1 | 83.5 | 78.6 | 73.9 | | | | | | | | |
| 12 | 80.7 | 78.6 | 74.9 | 71.0 | 65.4 | | | | | | | |
| 13 | 74.7 | 74.0 | 70.7 | 67.6 | 63.0 | 56.4 | 51.2 | 48.1 | | 42.6 | | 36.4 |
| 14 | 69.4 | 69.7 | 67.4 | 64.3 | 60.3 | 55.8 | 50.8 | 47.8 | 43.6 | 42.2 | 37.1 | 36.1 |
| 16 | 60.5 | 61.1 | 61.0 | 58.7 | 55.5 | 52.3 | 48.3 | 46.8 | 42.5 | 41.0 | 35.6 | 35.4 |
| 18 | 53.2 | 54.0 | 54.6 | 53.4 | 50.9 | 47.9 | 45.6 | 44.9 | 40.7 | 38.8 | 33.8 | 34.3 |
| 20 | 47.3 | 48.0 | 48.7 | 48.4 | 47.0 | 44.2 | 42.7 | 41.8 | 38.6 | 36.8 | 32.0 | 32.8 |
| 22 | 42.0 | 42.9 | 43.7 | 43.8 | 43.1 | 41.1 | 39.7 | 38.8 | 36.7 | 34.9 | 30.5 | 31.3 |
| 24 | 37.4 | 38.4 | 39.0 | 39.2 | 39.3 | 38.0 | 36.9 | 36.2 | 34.8 | 33.3 | 29.1 | 29.8 |
| 26 | 30.6 | 34.4 | 35.2 | 35.3 | 35.5 | 35.1 | 34.3 | 33.6 | 32.7 | 31.4 | 27.9 | 28.6 |
| 28 | 16.5 | 31.0 | 31.8 | 32.0 | 32.1 | 32.0 | 31.8 | 31.3 | 30.5 | 29.2 | 26.7 | 27.3 |
| 30 | | 26.7 | 28.9 | 29.1 | 29.2 | 29.1 | 29.2 | 29.0 | 28.5 | 27.2 | 25.6 | 26.1 |
| 32 | | 19.4 | 26.4 | 26.5 | 26.7 | 26.5 | 26.7 | 26.5 | 26.5 | 25.4 | 24.5 | 24.7 |
| 34 | | | 23.3 | 24.3 | 24.5 | 24.3 | 24.4 | 24.2 | 24.4 | 23.6 | 23.3 | 23.2 |
| 36 | | | 18.5 | 22.3 | 22.5 | 22.3 | 22.4 | 22.2 | 22.4 | 21.7 | 21.7 | 21.6 |
| 38 | | | 10.0 | 20.0 | 20.7 | 20.5 | 20.6 | 20.4 | 20.6 | 19.9 | 20.0 | 20.0 |
| 40 | | | | 16.5 | 19.0 | 18.9 | 19.1 | 18.8 | 19.0 | 18.3 | 18.5 | 18.5 |
| 42 | | | | 11.6 | 17.3 | 17.4 | 17.6 | 17.3 | 17.5 | 16.7 | 17.0 | 17.0 |
| 44 | | | | | 14.6 | 15.9 | 16.1 | 15.9 | 16.1 | 15.3 | 15.6 | 15.7 |
| 46 | | | | | 11.2 | 14.6 | 14.9 | 14.6 | 14.8 | 14.0 | 14.3 | 14.3 |
| 48 | | | | | 5.4 | 12.4 | 13.7 | 13.4 | 13.6 | 12.9 | 13.1 | 13.2 |
| 50 | | | | | | 9.8 | 12.1 | 12.3 | 12.5 | 11.7 | 12.0 | 12.0 |
| 52 | | | | | | 6.3 | 10.1 | 10.6 | 11.5 | 10.7 | 10.9 | 11.0 |
| 54 | | | | | | | 7.6 | 8.5 | 10.3 | 9.8 | 10.0 | 10.1 |
| 56 | | | | | | | 3.9 | 6.0 | 8.6 | 8.4 | 9.2 | 9.2 |
| 58 | | | | | | | | | 6.7 | 6.8 | 8.2 | 8.3 |
| 60 | | | | | | | | | 4.1 | 4.8 | 6.8 | 7.1 |
| 62 | | | | | | | | | | 2.3 | 5.3 | 5.7 |
| 64 | | | | | | | | | | | 3.4 | 3.9 |
| 66 | | | | | | | | | | | | 1.8 |

60101

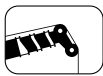

30.1m-70m

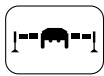

8.9m×8.53m



360°



100t



| メインブーム 長さ 作業半径(m) | 30.1m | 35.2m | 40.3m | 45.3m | 50.4m | 55.5m | 59m | 60.5m | 64m | 65.6m | 69.1m | 70m |
|-------------------------|-------|-------|-------|-------|-------|-------|------|-------|------|-------|-------|------|
| 4.5 | 116.1 | | | | | | | | | | | |
| 5 | 118.4 | | | | | | | | | | | |
| 6 | 119.0 | 104.9 | | | | | | | | | | |
| 7 | 116.9 | 106.9 | 90.3 | | | | | | | | | |
| 8 | 108.4 | 101.6 | 90.2 | 75.7 | | | | | | | | |
| 9 | 99.6 | 94.9 | 88.5 | 76.1 | 65.8 | | | | | | | |
| 10 | 91.6 | 89.2 | 84.8 | 76.1 | 66.0 | | | | | | | |
| 11 | 84.7 | 83.5 | 79.6 | 74.7 | 66.0 | 56.5 | 51.4 | 48.2 | | | | |
| 12 | 77.6 | 77.8 | 74.9 | 71.0 | 65.4 | 56.5 | 51.4 | 48.2 | 44.0 | 42.8 | | 36.2 |
| 13 | 70.8 | 71.5 | 70.7 | 67.6 | 63.0 | 56.4 | 51.2 | 48.1 | 43.9 | 42.6 | 37.8 | 36.4 |
| 14 | 65.0 | 65.6 | 66.0 | 64.3 | 60.3 | 55.8 | 50.8 | 47.8 | 43.6 | 42.2 | 37.1 | 36.1 |
| 16 | 55.3 | 56.2 | 56.8 | 57.0 | 55.5 | 52.3 | 48.3 | 46.8 | 42.5 | 41.0 | 35.6 | 35.4 |
| 18 | 47.8 | 48.6 | 49.4 | 49.5 | 49.5 | 47.7 | 45.6 | 44.9 | 40.7 | 38.8 | 33.8 | 34.3 |
| 20 | 41.8 | 42.6 | 43.4 | 43.5 | 43.6 | 42.5 | 41.8 | 41.1 | 38.6 | 36.8 | 32.0 | 32.8 |
| 22 | 36.7 | 37.6 | 38.4 | 38.5 | 38.7 | 37.8 | 37.3 | 36.7 | 36.0 | 34.8 | 30.5 | 31.3 |
| 24 | 32.6 | 33.5 | 34.2 | 34.4 | 34.5 | 33.9 | 33.4 | 32.9 | 32.5 | 31.3 | 29.1 | 29.7 |
| 26 | 28.7 | 29.8 | 30.7 | 30.8 | 31.0 | 30.5 | 30.1 | 29.6 | 29.3 | 28.2 | 27.5 | 27.9 |
| 28 | 16.5 | 26.5 | 27.4 | 27.6 | 27.8 | 27.5 | 27.2 | 26.7 | 26.5 | 25.4 | 25.2 | 25.1 |
| 30 | | 23.5 | 24.5 | 24.8 | 24.9 | 24.7 | 24.6 | 24.2 | 24.0 | 22.9 | 22.8 | 22.7 |
| 32 | | 19.4 | 22.0 | 22.2 | 22.4 | 22.2 | 22.3 | 21.9 | 21.7 | 20.7 | 20.6 | 20.6 |
| 34 | | | 19.7 | 20.0 | 20.2 | 20.0 | 20.2 | 19.9 | 19.8 | 18.8 | 18.7 | 18.7 |
| 36 | | | 17.7 | 18.0 | 18.2 | 18.0 | 18.2 | 17.9 | 18.0 | 17.0 | 17.0 | 17.0 |
| 38 | | | 10.0 | 16.2 | 16.5 | 16.3 | 16.5 | 16.2 | 16.4 | 15.4 | 15.5 | 15.5 |
| 40 | | | | 14.6 | 14.9 | 14.7 | 14.9 | 14.6 | 14.8 | 14.0 | 14.1 | 14.1 |
| 42 | | | | 11.6 | 13.5 | 13.3 | 13.5 | 13.2 | 13.4 | 12.6 | 12.8 | 12.8 |
| 44 | | | | | 12.2 | 12.0 | 12.2 | 12.0 | 12.2 | 11.4 | 11.6 | 11.6 |
| 46 | | | | | 10.9 | 10.8 | 11.0 | 10.8 | 11.0 | 10.2 | 10.5 | 10.5 |
| 48 | | | | | 5.4 | 9.8 | 10.0 | 9.7 | 9.9 | 9.2 | 9.4 | 9.5 |
| 50 | | | | | | 8.8 | 9.0 | 8.7 | 8.9 | 8.2 | 8.5 | 8.5 |
| 52 | | | | | | 6.3 | 8.1 | 7.8 | 8.0 | 7.3 | 7.5 | 7.6 |
| 54 | | | | | | | 7.2 | 6.9 | 7.2 | 6.5 | 6.7 | 6.7 |
| 56 | | | | | | | 3.9 | 5.7 | 6.4 | 5.7 | 5.9 | 6.0 |
| 58 | | | | | | | | | 5.7 | 5.0 | 5.2 | 5.2 |
| 60 | | | | | | | | | 4.1 | 4.3 | 4.6 | 4.6 |
| 62 | | | | | | | | | | 2.3 | 3.9 | 3.9 |
| 64 | | | | | | | | | | | 3.1 | 3.3 |
| 66 | | | | | | | | | | | | 1.8 |

60105

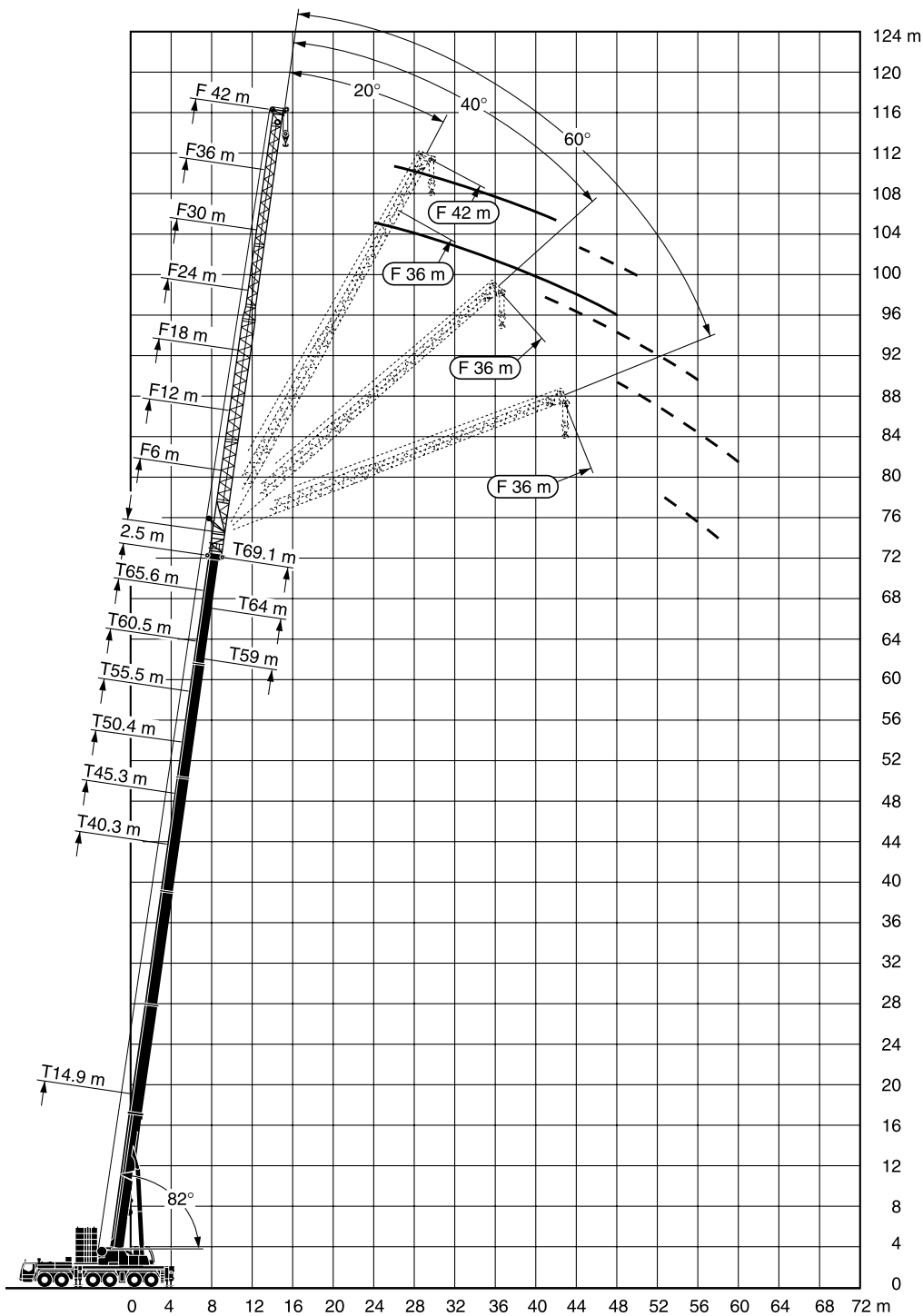

注意

- 1 定格総荷重はフックブロック、玉掛ワイヤー等の自重を含みます。
また、下記の条件が考慮されていませんのでクレーンの操作には充分気をつけてください。
 - ① 地盤の強度、地震による影響
 - ② 作業速度に応じた動荷重および台風または強風による影響等
- 2 本機は水平に設置して、クレーン作業を行ってください。
- 3 作業半径は、クレーンの旋回中心から荷重の重心までの水平距離です。
- 4 メインブームの定格総荷重は補助ジブを取り除いた状態での値です。
- 5 メインブーム70m仕様で200トンを超える定格総荷重の場合は、特殊吊装置が必要です。

固定式ジブ定格総荷重表 TF

LTM 1400NX



14.9m-65.6m



0°/20°/40°/60°
6m

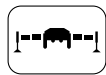

8.9m×8.53m



360°



100t

| メインブーム長さ ジブ長さ 作業半径(m) | 14.9m+2.5m 6m | | | | 40.3m+2.5m 6m | | | | 45.3m+2.5m 6m | | | | 50.4m+2.5m 6m | | | |
|-----------------------------|------------------|------|------|------|------------------|------|------|------|------------------|------|------|------|------------------|------|------|------|
| | 0° | 20° | 40° | 60° | 0° | 20° | 40° | 60° | 0° | 20° | 40° | 60° | 0° | 20° | 40° | 60° |
| 3.5 | 45.0 | | | | | | | | | | | | | | | |
| 4.0 | 44.4 | | | | | | | | | | | | | | | |
| 4.5 | 43.0 | | | | | | | | | | | | | | | |
| 5 | 41.1 | | | | | | | | | | | | | | | |
| 6 | 37.4 | 33.1 | | | | | | | | | | | | | | |
| 7 | 34.2 | 30.6 | 27.7 | | | | | | | | | | | | | |
| 8 | 31.3 | 28.4 | 26.0 | 24.3 | 45.0 | | | | | | | | | | | |
| 9 | 28.9 | 26.5 | 24.5 | 23.9 | 44.4 | | | | | | | | | | | |
| 10 | 26.8 | 24.9 | 23.2 | 22.8 | 43.0 | 34.4 | | | 36.2 | | | | | | | |
| 11 | 25.1 | 23.4 | 22.1 | 21.9 | 41.1 | 33.1 | | | 36.2 | | | | 29.7 | | | |
| 12 | 23.4 | 22.2 | 21.0 | 21.1 | 39.3 | 31.9 | 27.2 | | 35.9 | 31.4 | | | 29.4 | | | |
| 13 | 22.0 | 21.1 | 20.1 | 20.7 | 37.7 | 30.7 | 26.4 | 24.3 | 34.8 | 30.4 | 26.2 | | 28.8 | | | |
| 14 | 20.7 | 20.0 | 19.3 | 20.2 | 36.0 | 29.6 | 25.7 | 24.3 | 33.3 | 29.5 | 25.6 | 24.1 | 27.7 | 27.5 | | |
| 16 | 18.6 | 18.2 | 18.0 | 14.6 | 33.1 | 27.8 | 24.4 | 23.3 | 30.5 | 27.7 | 24.4 | 23.2 | 25.5 | 25.4 | 24.2 | 22.9 |
| 18 | 17.0 | 16.7 | 16.9 | 5.5 | 30.5 | 26.1 | 23.2 | 22.4 | 28.0 | 26.2 | 23.4 | 22.4 | 23.5 | 23.5 | 23.2 | 22.1 |
| 20 | 15.7 | 15.7 | 9.0 | | 28.4 | 24.6 | 22.2 | | 25.7 | 24.8 | 22.5 | 21.7 | 21.8 | 21.7 | 21.8 | 21.5 |
| 22 | | | | | 26.4 | 23.3 | 21.3 | | 23.5 | 23.3 | 21.5 | | 20.1 | 20.1 | 20.2 | 20.4 |
| 24 | | | | | 24.8 | 22.2 | 20.5 | | 21.5 | 21.5 | 20.7 | | 18.6 | 18.6 | 18.7 | |
| 26 | | | | | 23.3 | 21.2 | 19.7 | | 19.8 | 19.7 | 19.6 | | 17.2 | 17.2 | 17.2 | |
| 28 | | | | | 22.0 | 20.2 | 19.1 | | 18.2 | 18.2 | 18.3 | | 15.9 | 15.9 | 16.0 | |
| 30 | | | | | 20.8 | 19.3 | 18.5 | | 16.7 | 16.8 | 16.8 | | 14.6 | 14.7 | 14.8 | |
| 32 | | | | | 19.7 | 18.5 | 18.0 | | 15.4 | 15.5 | 15.6 | | 13.4 | 13.5 | 13.7 | |
| 34 | | | | | 18.8 | 17.8 | | | 14.2 | 14.3 | 14.4 | | 12.4 | 12.5 | 12.7 | |
| 36 | | | | | 17.7 | 17.1 | | | 13.1 | 13.2 | | | 11.4 | 11.5 | 11.7 | |
| 38 | | | | | 16.3 | 16.4 | | | 12.2 | 12.2 | | | 10.5 | 10.6 | 10.8 | |
| 40 | | | | | 14.8 | 15.1 | | | 11.4 | 11.4 | | | 9.7 | 9.8 | | |
| 42 | | | | | 13.6 | | | | 10.7 | 10.7 | | | 9.0 | 9.0 | | |
| 44 | | | | | 12.4 | | | | 10.0 | 10.0 | | | 8.3 | 8.4 | | |
| 46 | | | | | 9.0 | | | | 9.4 | 9.4 | | | 7.7 | 7.9 | | |
| 48 | | | | | | | | | 8.9 | | | | 7.2 | 7.3 | | |
| 50 | | | | | | | | | 8.4 | | | | 6.8 | 6.8 | | |
| 52 | | | | | | | | | | | | | 6.3 | | | |
| 54 | | | | | | | | | | | | | 5.9 | | | |
| 56 | | | | | | | | | | | | | 4.8 | | | |

| メインブーム長さ ジブ長さ 作業半径(m) | 55.5m+2.5m 6m | | | | 60.5m+2.5m 6m | | | | 65.6m+2.5m 6m | | | |
|-----------------------------|------------------|------|------|------|------------------|------|------|------|------------------|------|------|------|
| | 0° | 20° | 40° | 60° | 0° | 20° | 40° | 60° | 0° | 20° | 40° | 60° |
| 12 | 23.6 | | | | | | | | | | | |
| 13 | 23.4 | | | | | | | | | | | |
| 14 | 23.1 | | | | 18.7 | | | | | | | |
| 16 | 21.6 | 21.5 | | | 18.2 | 17.9 | | | 14.9 | | | |
| 18 | 20.0 | 20.0 | 20.3 | 20.6 | 17.2 | 17.1 | 17.1 | | 14.5 | 14.2 | | |
| 20 | 18.6 | 18.7 | 18.9 | 19.3 | 16.0 | 16.1 | 16.2 | 16.5 | 13.8 | 13.7 | 13.8 | |
| 22 | 17.3 | 17.4 | 17.6 | 17.9 | 15.0 | 15.1 | 15.3 | 15.5 | 13.0 | 13.0 | 13.1 | 13.3 |
| 24 | 16.0 | 16.2 | 16.3 | 16.6 | 13.9 | 14.1 | 14.4 | 14.6 | 12.3 | 12.3 | 12.4 | 12.7 |
| 26 | 14.9 | 15.0 | 15.2 | | 13.0 | 13.2 | 13.4 | 13.7 | 11.5 | 11.6 | 11.8 | 12.0 |
| 28 | 13.8 | 14.0 | 14.1 | | 12.1 | 12.3 | 12.5 | | 10.8 | 11.0 | 11.1 | 11.3 |
| 30 | 12.8 | 13.0 | 13.1 | | 11.3 | 11.5 | 11.7 | | 10.1 | 10.3 | 10.5 | |
| 32 | 11.9 | 12.0 | 12.1 | | 10.5 | 10.7 | 10.9 | | 9.4 | 9.7 | 9.8 | |
| 34 | 11.0 | 11.2 | 11.3 | | 9.8 | 10.0 | 10.2 | | 8.8 | 9.0 | 9.2 | |
| 36 | 10.2 | 10.3 | 10.4 | | 9.1 | 9.3 | 9.4 | | 8.2 | 8.4 | 8.6 | |
| 38 | 9.4 | 9.6 | 9.7 | | 8.4 | 8.6 | 8.7 | | 7.6 | 7.9 | 8.0 | |
| 40 | 8.6 | 8.8 | 8.9 | | 7.8 | 8.0 | 8.1 | | 7.1 | 7.3 | 7.5 | |
| 42 | 7.9 | 8.1 | 8.2 | | 7.2 | 7.4 | 7.5 | | 6.6 | 6.8 | 7.0 | |
| 44 | 7.3 | 7.5 | | | 6.6 | 6.8 | 6.9 | | 6.1 | 6.4 | 6.4 | |
| 46 | 6.7 | 6.9 | | | 6.1 | 6.3 | | | 5.7 | 5.9 | 6.0 | |
| 48 | 6.2 | 6.4 | | | 5.6 | 5.8 | | | 5.2 | 5.4 | 5.5 | |
| 50 | 5.8 | 5.9 | | | 5.2 | 5.3 | | | 4.8 | 5.0 | | |
| 52 | 5.4 | 5.5 | | | 4.8 | 4.9 | | | 4.4 | 4.6 | | |
| 54 | 5.0 | 5.1 | | | 4.5 | 4.6 | | | 4.0 | 4.2 | | |
| 56 | 4.6 | | | | 4.1 | 4.2 | | | 3.6 | 3.8 | | |
| 58 | 4.3 | | | | 3.8 | 3.9 | | | 3.3 | 3.4 | | |
| 60 | 4.0 | | | | 3.5 | | | | 3.0 | 3.1 | | |
| 62 | | | | | 3.3 | | | | 2.7 | 2.8 | | |
| 64 | | | | | 3.1 | | | | 2.4 | | | |
| 66 | | | | | 2.8 | | | | 2.1 | | | |
| 68 | | | | | | | | | 1.9 | | | |
| 70 | | | | | | | | | 1.6 | | | |

51105/25/45/65

固定式ジブ定格総荷重表 TF

LTM 1400NX

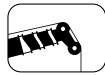

14.9m-65.6m



0°/20°/40°/60°
12m

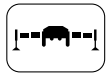

8.9m×8.53m

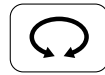

360°

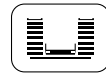

100t

| メインブーム長さ ジブ長さ 作業半径(m) | 14.9m+2.5m 12m | | | | 40.3m+2.5m 12m | | | | 45.3m+2.5m 12m | | | | 50.4m+2.5m 12m | | | |
|-----------------------------|-------------------|------|------|------|-------------------|------|------|------|-------------------|------|------|------|-------------------|------|------|------|
| | 0° | 20° | 40° | 60° | 0° | 20° | 40° | 60° | 0° | 20° | 40° | 60° | 0° | 20° | 40° | 60° |
| 4.5 | 32.4 | | | | | | | | | | | | | | | |
| 5 | 31.5 | | | | | | | | | | | | | | | |
| 6 | 29.0 | | | | | | | | | | | | | | | |
| 7 | 26.9 | | | | | | | | | | | | | | | |
| 8 | 25.0 | | | | | | | | | | | | | | | |
| 9 | 23.3 | 20.3 | | | | | | | | | | | | | | |
| 10 | 21.7 | 19.0 | | | 31.2 | | | | | | | | | | | |
| 11 | 20.2 | 17.9 | | | 29.8 | | | | 28.5 | | | | | | | |
| 12 | 18.9 | 16.9 | 15.3 | | 28.6 | | | | 27.5 | | | | 23.8 | | | |
| 13 | 17.7 | 16.0 | 14.6 | | 27.5 | | | | 26.5 | | | | 23.7 | | | |
| 14 | 16.7 | 15.2 | 14.0 | 12.2 | 26.4 | 20.2 | | | 25.6 | | | | 23.5 | | | |
| 16 | 15.0 | 13.8 | 12.9 | 12.2 | 24.4 | 18.9 | | | 24.0 | 18.8 | | | 22.2 | | | |
| 18 | 13.5 | 12.6 | 11.9 | 12.1 | 22.7 | 17.8 | 14.9 | 12.2 | 22.5 | 17.8 | 14.9 | | 20.7 | 17.4 | | |
| 20 | 12.3 | 11.7 | 11.2 | 11.8 | 20.9 | 16.8 | 14.2 | 12.2 | 21.1 | 16.8 | 14.3 | 12.2 | 19.3 | 16.6 | 14.1 | |
| 22 | 11.3 | 10.9 | 10.6 | 11.3 | 19.5 | 15.8 | 13.6 | 12.2 | 19.8 | 16.0 | 13.7 | 12.2 | 18.0 | 15.8 | 13.6 | 12.2 |
| 24 | 10.5 | 10.3 | 10.2 | 4.4 | 18.2 | 15.0 | 13.1 | 12.2 | 18.5 | 15.2 | 13.2 | 12.2 | 16.8 | 15.1 | 13.1 | 12.2 |
| 26 | 9.9 | 9.8 | 7.5 | | 17.1 | 14.3 | 12.6 | | 17.5 | 14.5 | 12.7 | 12.2 | 15.6 | 14.5 | 12.7 | 12.2 |
| 28 | | | | | 16.1 | 13.6 | 12.2 | | 16.4 | 13.9 | 12.3 | | 14.6 | 13.9 | 12.3 | 12.0 |
| 30 | | | | | 15.1 | 13.0 | 11.8 | | 15.4 | 13.3 | 12.0 | | 13.6 | 13.2 | 12.0 | |
| 32 | | | | | 14.3 | 12.5 | 11.5 | | 14.4 | 12.8 | 11.6 | | 12.6 | 12.6 | 11.6 | |
| 34 | | | | | 13.6 | 12.0 | 11.1 | | 13.4 | 12.3 | 11.3 | | 11.7 | 11.8 | 11.3 | |
| 36 | | | | | 13.0 | 11.6 | 10.9 | | 12.4 | 11.9 | 11.0 | | 10.8 | 11.0 | 10.9 | |
| 38 | | | | | 12.3 | 11.2 | 10.6 | | 11.5 | 11.4 | 10.8 | | 10.1 | 10.2 | 10.4 | |
| 40 | | | | | 11.8 | 10.8 | | | 10.7 | 10.9 | 10.6 | | 9.3 | 9.5 | 9.7 | |
| 42 | | | | | 11.3 | 10.5 | | | 9.9 | 10.2 | | | 8.6 | 8.8 | 9.0 | |
| 44 | | | | | 10.9 | 10.2 | | | 9.2 | 9.5 | | | 8.0 | 8.2 | 8.4 | |
| 46 | | | | | 10.5 | 10.0 | | | 8.5 | 8.8 | | | 7.4 | 7.6 | | |
| 48 | | | | | 10.2 | | | | 8.0 | 8.2 | | | 6.8 | 7.0 | | |
| 50 | | | | | 9.9 | | | | 7.5 | 7.7 | | | 6.3 | 6.5 | | |
| 52 | | | | | 6.9 | | | | 7.1 | | | | 5.8 | 6.0 | | |
| 54 | | | | | | | | | 6.7 | | | | 5.4 | 5.5 | | |
| 56 | | | | | | | | | 6.3 | | | | 5.0 | 5.1 | | |
| 58 | | | | | | | | | | | | | 4.7 | | | |
| 60 | | | | | | | | | | | | | 4.4 | | | |
| 62 | | | | | | | | | | | | | 3.4 | | | |

| メインブーム長さ ジブ長さ 作業半径(m) | 55.5m+2.5m 12m | | | | 60.5m+2.5m 12m | | | | 65.6m+2.5m 12m | | | |
|-----------------------------|-------------------|------|------|------|-------------------|------|------|------|-------------------|------|------|-----|
| | 0° | 20° | 40° | 60° | 0° | 20° | 40° | 60° | 0° | 20° | 40° | 60° |
| 14 | 18.8 | | | | | | | | | | | |
| 16 | 18.4 | | | | 14.8 | | | | | | | |
| 18 | 17.5 | | | | 14.5 | | | | | | | |
| 20 | 16.4 | 15.9 | | | 13.9 | | | | | 11.7 | | |
| 22 | 15.4 | 15.2 | 13.2 | | 13.1 | 13.1 | | | | 11.4 | | |
| 24 | 14.4 | 14.5 | 12.8 | 12.2 | 12.4 | 12.4 | 11.9 | | | 11.0 | 10.4 | |
| 26 | 13.4 | 13.7 | 12.4 | 12.0 | 11.6 | 11.7 | 11.3 | | | 10.5 | 10.0 | |
| 28 | 12.5 | 12.8 | 12.1 | 11.8 | 10.9 | 11.1 | 10.8 | 11.4 | | 10.0 | 9.5 | 9.2 |
| 30 | 11.7 | 12.0 | 11.8 | 11.6 | 10.2 | 10.5 | 10.3 | 10.9 | | 9.5 | 9.1 | 8.8 |
| 32 | 10.9 | 11.2 | 11.3 | | 9.5 | 9.8 | 9.8 | 10.4 | | 9.0 | 8.7 | 8.5 |
| 34 | 10.2 | 10.4 | 10.7 | | 8.9 | 9.2 | 9.3 | 9.9 | | 8.4 | 8.3 | 8.1 |
| 36 | 9.5 | 9.7 | 9.9 | | 8.3 | 8.6 | 8.7 | | | 8.0 | 7.8 | 7.9 |
| 38 | 8.9 | 9.0 | 9.2 | | 7.8 | 8.1 | 8.2 | | | 7.9 | 7.6 | 7.5 |
| 40 | 8.2 | 8.4 | 8.6 | | 7.3 | 7.5 | 7.7 | | | 7.4 | 7.6 | 7.5 |
| 42 | 7.6 | 7.8 | 8.0 | | 6.8 | 7.0 | 7.2 | | | 6.9 | 7.1 | 7.2 |
| 44 | 7.0 | 7.2 | 7.4 | | 6.3 | 6.5 | 6.7 | | | 6.5 | 6.7 | 6.8 |
| 46 | 6.4 | 6.7 | 6.8 | | 5.8 | 6.0 | 6.2 | | | 6.1 | 6.3 | 6.5 |
| 48 | 5.9 | 6.2 | 6.3 | | 5.3 | 5.5 | 5.7 | | | 5.6 | 5.9 | 6.1 |
| 50 | 5.5 | 5.7 | | | 4.9 | 5.1 | 5.3 | | | 5.2 | 5.5 | 5.7 |
| 52 | 5.0 | 5.2 | | | 4.5 | 4.7 | | | | 4.8 | 5.1 | 5.3 |
| 54 | 4.6 | 4.7 | | | 4.1 | 4.3 | | | | 4.5 | 4.8 | 4.9 |
| 56 | 4.3 | 4.4 | | | 3.8 | 3.9 | | | | 4.4 | 4.7 | 4.9 |
| 58 | 3.9 | 4.0 | | | 3.5 | 3.6 | | | | 4.1 | 4.4 | 4.5 |
| 60 | 3.7 | 3.7 | | | 3.2 | 3.4 | | | | 4.0 | 4.1 | |
| 62 | 3.4 | | | | 3.0 | 3.1 | | | | 3.7 | | |
| 64 | 3.2 | | | | 2.8 | 2.9 | | | | 3.4 | | |
| 66 | 3.0 | | | | 2.6 | | | | | 3.1 | | |
| 68 | | | | | 2.4 | | | | | 2.8 | | |
| 70 | | | | | 2.2 | | | | | 2.5 | | |
| 72 | | | | | 1.7 | | | | | 2.3 | | |

51205/25/45/65

固定式ジブ定格総荷重表 TF

LTM 1400NX



14.9m-65.6m



0°/20°/40°/60°
18m

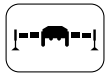

8.9m x 8.53m

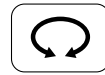

360°

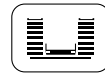

100t

| メインブーム長さ ジブ長さ 作業半径(m) | 14.9m+2.5m 18m | | | | 40.3m+2.5m 18m | | | | 45.3m+2.5m 18m | | | | 50.4m+2.5m 18m | | | |
|-----------------------------|-------------------|------|-----|-----|-------------------|------|------|-----|-------------------|------|-----|-----|-------------------|------|-----|-----|
| | 0° | 20° | 40° | 60° | 0° | 20° | 40° | 60° | 0° | 20° | 40° | 60° | 0° | 20° | 40° | 60° |
| 6 | 23.5 | | | | | | | | | | | | | | | |
| 7 | 22.0 | | | | | | | | | | | | | | | |
| 8 | 20.5 | | | | | | | | | | | | | | | |
| 9 | 19.3 | | | | | | | | | | | | | | | |
| 10 | 18.1 | | | | | | | | | | | | | | | |
| 11 | 17.1 | | | | 23.3 | | | | | | | | | | | |
| 12 | 16.1 | 13.9 | | | 22.3 | | | | 21.3 | | | | | | | |
| 13 | 15.1 | 13.2 | | | 21.5 | | | | 20.6 | | | | | | | |
| 14 | 14.3 | 12.5 | | | 20.6 | | | | 19.9 | | | | 18.5 | | | |
| 16 | 12.7 | 11.3 | | | 19.2 | | | | 18.6 | | | | 17.6 | | | |
| 18 | 11.5 | 10.3 | 9.8 | | 17.8 | 13.4 | | | 17.5 | 13.4 | | | 16.7 | | | |
| 20 | 10.4 | 9.4 | 9.0 | 7.1 | 16.7 | 12.6 | | | 16.5 | 12.6 | | | 15.8 | 12.2 | | |
| 22 | 9.5 | 8.7 | 8.4 | 7.0 | 15.5 | 11.9 | 10.2 | | 15.5 | 12.0 | | | 15.0 | 12.1 | | |
| 24 | 8.7 | 8.1 | 7.9 | 6.9 | 14.5 | 11.3 | 9.8 | 7.2 | 14.6 | 11.4 | 9.8 | | 14.3 | 11.5 | 9.6 | |
| 26 | 8.0 | 7.5 | 7.5 | 6.8 | 13.5 | 10.7 | 9.4 | 7.1 | 13.8 | 10.8 | 9.4 | 7.1 | 13.6 | 11.0 | 9.3 | |
| 28 | 7.5 | 7.1 | 7.1 | 6.6 | 12.7 | 10.2 | 9.0 | 7.0 | 13.0 | 10.3 | 9.1 | 7.0 | 12.9 | 10.5 | 9.0 | 7.0 |
| 30 | 7.0 | 6.7 | 6.9 | | 12.0 | 9.7 | 8.7 | 7.0 | 12.2 | 9.9 | 8.8 | 7.0 | 12.2 | 10.1 | 8.7 | 7.0 |
| 32 | 6.6 | 6.5 | | | 11.3 | 9.3 | 8.4 | | 11.6 | 9.5 | 8.5 | 6.9 | 11.5 | 9.7 | 8.4 | 6.9 |
| 34 | | | | | 10.6 | 8.9 | 8.1 | | 11.0 | 9.1 | 8.2 | | 10.8 | 9.3 | 8.2 | 6.9 |
| 36 | | | | | 10.1 | 8.5 | 7.9 | | 10.4 | 8.7 | 8.0 | | 10.2 | 9.0 | 8.0 | |
| 38 | | | | | 9.6 | 8.2 | 7.7 | | 10.0 | 8.4 | 7.8 | | 9.5 | 8.7 | 7.8 | |
| 40 | | | | | 9.1 | 7.9 | 7.5 | | 9.5 | 8.1 | 7.6 | | 8.8 | 8.4 | 7.6 | |
| 42 | | | | | 8.7 | 7.6 | 7.3 | | 9.0 | 7.8 | 7.4 | | 8.2 | 8.1 | 7.4 | |
| 44 | | | | | 8.3 | 7.3 | 7.1 | | 8.6 | 7.6 | 7.2 | | 7.6 | 7.7 | 7.3 | |
| 46 | | | | | 7.9 | 7.1 | | | 8.2 | 7.4 | 7.1 | | 7.0 | 7.3 | 7.2 | |
| 48 | | | | | 7.6 | 6.9 | | | 7.7 | 7.2 | | | 6.5 | 6.9 | 7.0 | |
| 50 | | | | | 7.3 | 6.8 | | | 7.2 | 7.0 | | | 6.0 | 6.4 | 6.6 | |
| 52 | | | | | 7.0 | 6.6 | | | 6.7 | 6.7 | | | 5.6 | 5.9 | | |
| 54 | | | | | 6.8 | | | | 6.2 | 6.4 | | | 5.1 | 5.5 | | |
| 56 | | | | | 6.6 | | | | 5.8 | 6.0 | | | 4.7 | 5.1 | | |
| 58 | | | | | 5.3 | | | | 5.5 | | | | 4.4 | 4.7 | | |
| 60 | | | | | | | | | 5.2 | | | | 4.1 | 4.3 | | |
| 62 | | | | | | | | | 4.7 | | | | 3.8 | 3.9 | | |
| 64 | | | | | | | | | | | | | 3.5 | | | |
| 66 | | | | | | | | | | | | | 3.3 | | | |
| 68 | | | | | | | | | | | | | 2.4 | | | |

| メインブーム長さ ジブ長さ 作業半径(m) | 55.5m+2.5m 18m | | | | 60.5m+2.5m 18m | | | | 65.6m+2.5m 18m | | | |
|-----------------------------|-------------------|------|-----|-----|-------------------|------|-----|-----|-------------------|-----|-----|-----|
| | 0° | 20° | 40° | 60° | 0° | 20° | 40° | 60° | 0° | 20° | 40° | 60° |
| 16 | 15.4 | | | | 11.6 | | | | | | | |
| 18 | 15.1 | | | | 11.6 | | | | 9.2 | | | |
| 20 | 14.4 | | | | 11.3 | | | | 9.1 | | | |
| 22 | 13.6 | 11.5 | | | 11.0 | | | | 8.9 | | | |
| 24 | 12.8 | 11.1 | | | 10.6 | 10.3 | | | 8.6 | | | |
| 26 | 12.0 | 10.6 | 9.0 | | 10.1 | 9.9 | | | 8.3 | 7.9 | | |
| 28 | 11.3 | 10.2 | 8.8 | 7.0 | 9.6 | 9.5 | | | 8.0 | 7.6 | | |
| 30 | 10.6 | 9.8 | 8.5 | 6.9 | 9.1 | 9.0 | 8.2 | 6.9 | 7.7 | 7.2 | 6.8 | |
| 32 | 9.9 | 9.5 | 8.3 | 6.9 | 8.6 | 8.6 | 8.0 | 6.9 | 7.3 | 6.9 | 6.6 | |
| 34 | 9.3 | 9.1 | 8.1 | 6.9 | 8.1 | 8.2 | 7.8 | 6.9 | 7.0 | 6.6 | 6.4 | 6.3 |
| 36 | 8.7 | 8.8 | 7.9 | 6.9 | 7.6 | 7.8 | 7.6 | 6.9 | 6.6 | 6.4 | 6.1 | 6.2 |
| 38 | 8.1 | 8.4 | 7.7 | | 7.1 | 7.4 | 7.3 | 6.9 | 6.3 | 6.1 | 5.9 | 5.9 |
| 40 | 7.6 | 7.9 | 7.5 | | 6.7 | 7.0 | 7.0 | | 5.9 | 5.9 | 5.7 | 5.7 |
| 42 | 7.1 | 7.4 | 7.4 | | 6.2 | 6.6 | 6.7 | | 5.5 | 5.6 | 5.5 | |
| 44 | 6.6 | 6.9 | 7.1 | | 5.8 | 6.2 | 6.3 | | 5.2 | 5.3 | 5.3 | |
| 46 | 6.1 | 6.4 | 6.7 | | 5.4 | 5.8 | 6.0 | | 4.8 | 5.1 | 5.1 | |
| 48 | 5.7 | 6.0 | 6.2 | | 5.0 | 5.3 | 5.6 | | 4.5 | 4.8 | 4.8 | |
| 50 | 5.2 | 5.6 | 5.8 | | 4.7 | 5.0 | 5.2 | | 4.2 | 4.5 | 4.6 | |
| 52 | 4.8 | 5.2 | 5.3 | | 4.3 | 4.6 | 4.8 | | 3.9 | 4.2 | 4.4 | |
| 54 | 4.4 | 4.8 | 4.9 | | 4.0 | 4.2 | 4.4 | | 3.6 | 3.9 | 4.0 | |
| 56 | 4.0 | 4.4 | | | 3.7 | 3.9 | 4.1 | | 3.3 | 3.6 | 3.7 | |
| 58 | 3.7 | 4.0 | | | 3.3 | 3.6 | | | 3.0 | 3.3 | 3.4 | |
| 60 | 3.4 | 3.6 | | | 3.0 | 3.3 | | | 2.7 | 3.0 | 3.2 | |
| 62 | 3.2 | 3.3 | | | 2.8 | 3.0 | | | 2.5 | 2.7 | | |
| 64 | 3.0 | 3.1 | | | 2.6 | 2.7 | | | 2.2 | 2.4 | | |
| 66 | 2.7 | 2.8 | | | 2.4 | 2.5 | | | 1.9 | 2.2 | | |
| 68 | 2.6 | | | | 2.2 | 2.3 | | | 1.7 | 1.9 | | |
| 70 | 2.4 | | | | 2.0 | 2.1 | | | 1.5 | 1.7 | | |
| 72 | 2.2 | | | | 1.8 | | | | 1.2 | 1.4 | | |
| 74 | | | | | 1.7 | | | | | 1.2 | | |
| 76 | | | | | 1.5 | | | | | | | |

51305/25/45/65

固定式ジブ定格総荷重表 TF

LTM 1400NX

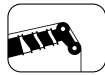

14.9m-65.6m



0°/20°/40°/60°
24m

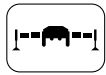

8.9m×8.53m



360°

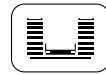

100t

| メインブーム長さ ジブ長さ 作業半径(m) | 14.9m+2.5m 24m | | | | 40.3m+2.5m 24m | | | | 45.3m+2.5m 24m | | | | 50.4m+2.5m 24m | | | |
|-----------------------------|-------------------|------|-----|-----|-------------------|------|-----|-----|-------------------|-----|-----|-----|-------------------|-----|-----|-----|
| | 0° | 20° | 40° | 60° | 0° | 20° | 40° | 60° | 0° | 20° | 40° | 60° | 0° | 20° | 40° | 60° |
| 7 | 17.9 | | | | | | | | | | | | | | | |
| 8 | 17.0 | | | | | | | | | | | | | | | |
| 9 | 16.0 | | | | | | | | | | | | | | | |
| 10 | 15.1 | | | | | | | | | | | | | | | |
| 11 | 14.3 | | | | | | | | | | | | | | | |
| 12 | 13.5 | | | | 17.7 | | | | | | | | | | | |
| 13 | 12.8 | | | | 17.1 | | | | 16.3 | | | | | | | |
| 14 | 12.2 | | | | 16.5 | | | | 15.8 | | | | | | | |
| 16 | 11.0 | 10.0 | | | 15.3 | | | | 14.8 | | | | 13.9 | | | |
| 18 | 9.8 | 9.0 | | | 14.3 | | | | 13.9 | | | | 13.2 | | | |
| 20 | 8.9 | 8.2 | | | 13.4 | 10.4 | | | 13.1 | | | | 12.5 | | | |
| 22 | 8.1 | 7.5 | 6.8 | | 12.6 | 9.8 | | | 12.4 | 9.7 | | | 11.9 | | | |
| 24 | 7.4 | 6.9 | 6.4 | | 11.8 | 9.2 | | | 11.7 | 9.2 | | | 11.3 | 9.0 | | |
| 26 | 6.8 | 6.4 | 6.0 | 4.3 | 11.0 | 8.7 | 7.0 | | 11.1 | 8.7 | | | 10.7 | 8.6 | | |
| 28 | 6.2 | 6.0 | 5.6 | 4.2 | 10.3 | 8.3 | 6.7 | | 10.4 | 8.3 | 6.7 | | 10.2 | 8.2 | | |
| 30 | 5.8 | 5.6 | 5.3 | 4.1 | 9.7 | 7.8 | 6.5 | 4.3 | 9.9 | 7.9 | 6.5 | | 9.7 | 7.8 | 6.5 | |
| 32 | 5.3 | 5.2 | 5.0 | 4.1 | 9.1 | 7.5 | 6.3 | 4.2 | 9.3 | 7.5 | 6.3 | 4.3 | 9.3 | 7.5 | 6.3 | 4.2 |
| 34 | 5.0 | 4.9 | 4.8 | 4.0 | 8.6 | 7.1 | 6.1 | 4.2 | 8.8 | 7.2 | 6.1 | 4.2 | 8.8 | 7.2 | 6.1 | 4.2 |
| 36 | 4.7 | 4.7 | 4.6 | | 8.1 | 6.8 | 5.9 | 4.2 | 8.3 | 6.9 | 5.9 | 4.2 | 8.4 | 6.9 | 5.9 | 4.2 |
| 38 | 4.5 | 4.5 | | | 7.6 | 6.5 | 5.7 | | 7.9 | 6.6 | 5.7 | 4.1 | 8.0 | 6.6 | 5.7 | 4.1 |
| 40 | | | | | 7.2 | 6.2 | 5.5 | | 7.5 | 6.3 | 5.5 | | 7.6 | 6.4 | 5.5 | 4.1 |
| 42 | | | | | 6.8 | 5.9 | 5.3 | | 7.1 | 6.1 | 5.4 | | 7.3 | 6.1 | 5.4 | |
| 44 | | | | | 6.5 | 5.7 | 5.2 | | 6.8 | 5.9 | 5.2 | | 6.9 | 5.9 | 5.3 | |
| 46 | | | | | 6.2 | 5.5 | 5.0 | | 6.5 | 5.7 | 5.1 | | 6.5 | 5.7 | 5.1 | |
| 48 | | | | | 5.9 | 5.3 | 4.9 | | 6.2 | 5.5 | 5.0 | | 6.1 | 5.5 | 5.0 | |
| 50 | | | | | 5.6 | 5.1 | 4.8 | | 5.9 | 5.3 | 4.9 | | 5.6 | 5.4 | 4.9 | |
| 52 | | | | | 5.4 | 4.9 | | | 5.7 | 5.1 | 4.8 | | 5.3 | 5.2 | 4.8 | |
| 54 | | | | | 5.2 | 4.8 | | | 5.4 | 5.0 | | | 4.8 | 5.0 | 4.8 | |
| 56 | | | | | 4.9 | 4.7 | | | 5.2 | 4.8 | | | 4.5 | 4.8 | 4.7 | |
| 58 | | | | | 4.8 | 4.6 | | | 5.0 | 4.7 | | | 4.1 | 4.5 | | |
| 60 | | | | | 4.6 | | | | 4.7 | 4.6 | | | 3.8 | 4.2 | | |
| 62 | | | | | 4.5 | | | | 4.3 | 4.5 | | | 3.4 | 3.8 | | |
| 64 | | | | | 3.8 | | | | 4.1 | | | | 3.2 | 3.5 | | |
| 66 | | | | | | | | | 3.8 | | | | 3.0 | 3.2 | | |
| 68 | | | | | | | | | 3.4 | | | | 2.8 | 2.9 | | |
| 70 | | | | | | | | | | | | | 2.6 | | | |
| 72 | | | | | | | | | | | | | 2.4 | | | |
| 74 | | | | | | | | | | | | | 1.6 | | | |

| メインブーム長さ ジブ長さ 作業半径(m) | 55.5m+2.5m 24m | | | | 60.5m+2.5m 24m | | | | 65.6m+2.5m 24m | | | |
|-----------------------------|-------------------|-----|-----|-----|-------------------|-----|-----|-----|-------------------|-----|-----|-----|
| | 0° | 20° | 40° | 60° | 0° | 20° | 40° | 60° | 0° | 20° | 40° | 60° |
| 18 | 11.9 | | | | 9.6 | | | | | | | |
| 20 | 11.6 | | | | 9.5 | | | | 7.5 | | | |
| 22 | 11.2 | | | | 9.3 | | | | 7.4 | | | |
| 24 | 10.8 | | | | 9.0 | | | | 7.2 | | | |
| 26 | 10.3 | 8.3 | | | 8.7 | | | | 6.9 | | | |
| 28 | 9.9 | 7.9 | | | 8.3 | 7.4 | | | 6.7 | | | |
| 30 | 9.4 | 7.6 | | | 7.9 | 7.2 | | | 6.4 | 5.8 | | |
| 32 | 8.9 | 7.3 | 6.2 | | 7.5 | 6.9 | | | 6.2 | 5.6 | | |
| 34 | 8.4 | 7.0 | 6.0 | 4.2 | 7.1 | 6.7 | 5.8 | | 5.9 | 5.4 | | |
| 36 | 7.9 | 6.8 | 5.8 | 4.1 | 6.7 | 6.5 | 5.6 | 4.1 | 5.6 | 5.2 | 4.6 | |
| 38 | 7.4 | 6.5 | 5.6 | 4.1 | 6.3 | 6.2 | 5.5 | 4.1 | 5.4 | 5.0 | 4.5 | |
| 40 | 6.9 | 6.3 | 5.5 | 4.1 | 6.0 | 6.0 | 5.3 | 4.1 | 5.1 | 4.8 | 4.4 | 4.1 |
| 42 | 6.5 | 6.1 | 5.3 | 4.1 | 5.6 | 5.8 | 5.2 | 4.1 | 4.8 | 4.6 | 4.2 | 4.1 |
| 44 | 6.1 | 5.9 | 5.2 | | 5.2 | 5.5 | 5.1 | 4.1 | 4.5 | 4.4 | 4.1 | 4.1 |
| 46 | 5.7 | 5.7 | 5.1 | | 4.9 | 5.2 | 5.0 | | 4.2 | 4.2 | 4.0 | 4.0 |
| 48 | 5.3 | 5.4 | 5.0 | | 4.5 | 4.9 | 4.9 | | 4.0 | 4.0 | 3.9 | |
| 50 | 4.9 | 5.2 | 4.9 | | 4.2 | 4.6 | 4.7 | | 3.7 | 3.8 | 3.7 | |
| 52 | 4.5 | 4.9 | 4.8 | | 3.9 | 4.3 | 4.5 | | 3.4 | 3.7 | 3.6 | |
| 54 | 4.2 | 4.5 | 4.6 | | 3.6 | 4.0 | 4.2 | | 3.1 | 3.5 | 3.5 | |
| 56 | 3.9 | 4.2 | 4.4 | | 3.3 | 3.7 | 3.9 | | 2.9 | 3.2 | 3.3 | |
| 58 | 3.5 | 3.8 | 4.0 | | 3.0 | 3.4 | 3.6 | | 2.6 | 3.0 | 3.2 | |
| 60 | 3.2 | 3.5 | | | 2.7 | 3.1 | 3.3 | | 2.4 | 2.7 | 3.0 | |
| 62 | 2.9 | 3.2 | | | 2.5 | 2.8 | 3.0 | | 2.1 | 2.5 | 2.8 | |
| 64 | 2.7 | 2.9 | | | 2.3 | 2.5 | | | 1.9 | 2.2 | 2.5 | |
| 66 | 2.5 | 2.7 | | | 2.0 | 2.3 | | | 1.7 | 2.0 | 2.2 | |
| 68 | 2.3 | 2.4 | | | 1.8 | 2.1 | | | 1.4 | 1.8 | | |
| 70 | 2.1 | 2.2 | | | 1.7 | 1.8 | | | 1.2 | 1.5 | | |
| 72 | 1.9 | 2.0 | | | 1.5 | 1.6 | | | | 1.2 | | |
| 74 | 1.7 | | | | 1.3 | 1.4 | | | | | | |
| 76 | 1.5 | | | | | 1.3 | | | | | | |

51405/25/45/65

固定式ジブ定格総荷重表 TF

LTM 1400NX



14.9m-65.6m



0°/20°/40°/60°
30m

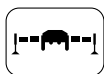

8.9m x 8.53m



360°



100t

| メインブーム長さ ジブ長さ 作業半径(m) | 14.9m+2.5m 30m | | | | 40.3m+2.5m 30m | | | | 45.3m+2.5m 30m | | | | 50.4m+2.5m 30m | | | |
|-----------------------------|-------------------|-----|-----|-----|-------------------|-----|-----|-----|-------------------|-----|-----|-----|-------------------|-----|-----|-----|
| | 0° | 20° | 40° | 60° | 0° | 20° | 40° | 60° | 0° | 20° | 40° | 60° | 0° | 20° | 40° | 60° |
| 8 | 12.2 | | | | | | | | | | | | | | | |
| 9 | 12.2 | | | | | | | | | | | | | | | |
| 10 | 12.2 | | | | | | | | | | | | | | | |
| 11 | 12.2 | | | | | | | | | | | | | | | |
| 12 | 11.8 | | | | | | | | | | | | | | | |
| 13 | 11.2 | | | | 12.2 | | | | | | | | | | | |
| 14 | 10.7 | | | | 12.2 | | | | 12.2 | | | | | | | |
| 16 | 9.7 | | | | 12.2 | | | | 12.2 | | | | 11.3 | | | |
| 18 | 8.9 | 7.6 | | | 12.0 | | | | 11.6 | | | | 10.9 | | | |
| 20 | 8.0 | 7.1 | | | 11.3 | | | | 11.0 | | | | 10.3 | | | |
| 22 | 7.3 | 6.5 | | | 10.6 | | | | 10.4 | | | | 9.8 | | | |
| 24 | 6.6 | 6.0 | | | 10.0 | 7.4 | | | 9.8 | | | | 9.4 | | | |
| 26 | 6.0 | 5.5 | 4.6 | | 9.4 | 7.1 | | | 9.3 | 7.0 | | | 8.9 | | | |
| 28 | 5.5 | 5.1 | 4.4 | | 8.9 | 6.7 | | | 8.8 | 6.7 | | | 8.5 | 6.6 | | |
| 30 | 5.1 | 4.7 | 4.1 | | 8.3 | 6.4 | | | 8.3 | 6.4 | | | 8.1 | 6.3 | | |
| 32 | 4.7 | 4.3 | 3.9 | 2.7 | 7.8 | 6.0 | 4.5 | | 7.9 | 6.1 | | | 7.8 | 6.0 | | |
| 34 | 4.3 | 4.0 | 3.7 | 2.7 | 7.3 | 5.7 | 4.4 | | 7.5 | 5.8 | 4.4 | | 7.4 | 5.7 | 4.4 | |
| 36 | 4.0 | 3.8 | 3.6 | 2.7 | 6.9 | 5.4 | 4.2 | 2.8 | 7.0 | 5.5 | 4.2 | | 7.0 | 5.5 | 4.2 | |
| 38 | 3.7 | 3.5 | 3.4 | 2.6 | 6.5 | 5.2 | 4.1 | 2.7 | 6.7 | 5.2 | 4.1 | 2.7 | 6.7 | 5.2 | 4.1 | 2.7 |
| 40 | 3.5 | 3.4 | 3.3 | 2.6 | 6.1 | 4.9 | 4.0 | 2.7 | 6.3 | 5.0 | 4.0 | 2.7 | 6.3 | 5.0 | 4.0 | 2.7 |
| 42 | 3.3 | 3.2 | 3.2 | | 5.8 | 4.7 | 3.9 | | 6.0 | 4.8 | 3.9 | 2.7 | 6.0 | 4.8 | 3.9 | 2.7 |
| 44 | 3.2 | 3.1 | | | 5.4 | 4.5 | 3.8 | | 5.7 | 4.6 | 3.8 | 2.7 | 5.7 | 4.6 | 3.8 | 2.7 |
| 46 | | | | | 5.1 | 4.3 | 3.7 | | 5.4 | 4.4 | 3.7 | | 5.5 | 4.4 | 3.7 | 2.6 |
| 48 | | | | | 4.9 | 4.1 | 3.6 | | 5.1 | 4.2 | 3.6 | | 5.2 | 4.3 | 3.7 | |
| 50 | | | | | 4.6 | 3.9 | 3.5 | | 4.9 | 4.1 | 3.6 | | 5.0 | 4.1 | 3.6 | |
| 52 | | | | | 4.4 | 3.8 | 3.5 | | 4.6 | 3.9 | 3.5 | | 4.8 | 3.9 | 3.5 | |
| 54 | | | | | 4.2 | 3.6 | 3.4 | | 4.4 | 3.8 | 3.4 | | 4.5 | 3.8 | 3.5 | |
| 56 | | | | | 4.0 | 3.5 | 3.3 | | 4.2 | 3.6 | 3.4 | | 4.3 | 3.7 | 3.4 | |
| 58 | | | | | 3.8 | 3.4 | | | 4.0 | 3.5 | 3.3 | | 3.9 | 3.6 | 3.3 | |
| 60 | | | | | 3.6 | 3.3 | | | 3.9 | 3.4 | | | 3.7 | 3.5 | 3.3 | |
| 62 | | | | | 3.5 | 3.2 | | | 3.7 | 3.3 | | | 3.4 | 3.4 | 3.3 | |
| 64 | | | | | 3.4 | 3.2 | | | 3.6 | 3.3 | | | 3.1 | 3.3 | | |
| 66 | | | | | 3.3 | | | | 3.4 | 3.2 | | | 2.9 | 3.1 | | |
| 68 | | | | | 3.2 | | | | 3.3 | 3.1 | | | 2.6 | 2.9 | | |
| 70 | | | | | | | | | 3.1 | | | | 2.4 | 2.6 | | |
| 72 | | | | | | | | | 3.0 | | | | 2.2 | 2.4 | | |
| 74 | | | | | | | | | 2.6 | | | | 2.0 | 2.2 | | |
| 76 | | | | | | | | | | | | | 1.9 | | | |
| 78 | | | | | | | | | | | | | 1.7 | | | |

| メインブーム長さ ジブ長さ 作業半径(m) | 55.5m+2.5m 30m | | | | 60.5m+2.5m 30m | | | | 65.6m+2.5m 30m | | | |
|-----------------------------|-------------------|-----|-----|-----|-------------------|-----|-----|-----|-------------------|-----|-----|-----|
| | 0° | 20° | 40° | 60° | 0° | 20° | 40° | 60° | 0° | 20° | 40° | 60° |
| 18 | 9.6 | | | | | | | | | | | |
| 20 | 9.4 | | | | 7.8 | | | | | | | |
| 22 | 9.0 | | | | 7.7 | | | | 5.9 | | | |
| 24 | 8.7 | | | | 7.5 | | | | 5.8 | | | |
| 26 | 8.3 | | | | 7.4 | | | | 5.7 | | | |
| 28 | 8.0 | | | | 7.1 | | | | 5.5 | | | |
| 30 | 7.7 | 6.0 | | | 6.8 | | | | 5.3 | | | |
| 32 | 7.4 | 5.8 | | | 6.5 | 5.4 | | | 5.1 | | | |
| 34 | 7.0 | 5.5 | | | 6.2 | 5.2 | | | 4.9 | 4.2 | | |
| 36 | 6.7 | 5.3 | 4.2 | | 5.9 | 5.0 | | | 4.6 | 4.1 | | |
| 38 | 6.4 | 5.1 | 4.1 | | 5.6 | 4.9 | | | 4.5 | 3.9 | | |
| 40 | 6.1 | 4.9 | 4.0 | 2.7 | 5.3 | 4.7 | 3.9 | | 4.3 | 3.7 | | |
| 42 | 5.8 | 4.7 | 3.9 | 2.7 | 5.0 | 4.5 | 3.8 | 2.6 | 4.1 | 3.6 | 3.2 | |
| 44 | 5.5 | 4.5 | 3.8 | 2.6 | 4.7 | 4.4 | 3.7 | 2.6 | 3.9 | 3.5 | 3.1 | |
| 46 | 5.2 | 4.4 | 3.7 | 2.6 | 4.4 | 4.2 | 3.6 | 2.6 | 3.7 | 3.4 | 3.1 | 2.6 |
| 48 | 4.9 | 4.2 | 3.6 | 2.6 | 4.1 | 4.1 | 3.6 | 2.6 | 3.4 | 3.3 | 3.0 | 2.6 |
| 50 | 4.5 | 4.1 | 3.6 | | 3.8 | 3.9 | 3.5 | 2.6 | 3.2 | 3.2 | 2.9 | 2.6 |
| 52 | 4.2 | 3.9 | 3.5 | | 3.5 | 3.8 | 3.4 | | 3.0 | 3.0 | 2.8 | 2.6 |
| 54 | 3.9 | 3.8 | 3.4 | | 3.2 | 3.6 | 3.4 | | 2.7 | 2.9 | 2.8 | |
| 56 | 3.6 | 3.7 | 3.4 | | 3.0 | 3.4 | 3.3 | | 2.5 | 2.8 | 2.7 | |
| 58 | 3.3 | 3.5 | 3.3 | | 2.7 | 3.2 | 3.3 | | 2.3 | 2.7 | 2.6 | |
| 60 | 3.0 | 3.3 | 3.3 | | 2.4 | 2.9 | 3.2 | | 2.0 | 2.5 | 2.6 | |
| 62 | 2.7 | 3.1 | 3.2 | | 2.2 | 2.7 | 3.0 | | 1.8 | 2.3 | 2.5 | |
| 64 | 2.5 | 2.9 | 3.1 | | 2.0 | 2.4 | 2.7 | | 1.6 | 2.1 | 2.3 | |
| 66 | 2.2 | 2.6 | | | 1.7 | 2.2 | 2.5 | | 1.4 | 1.8 | 2.1 | |
| 68 | 2.0 | 2.3 | | | 1.5 | 1.9 | 2.2 | | | 1.6 | 1.9 | |
| 70 | 1.8 | 2.1 | | | 1.3 | 1.7 | | | | 1.4 | 1.7 | |
| 72 | 1.6 | 1.8 | | | | 1.4 | | | | | 1.4 | |
| 74 | 1.4 | 1.6 | | | | 1.2 | | | | | | |
| 76 | 1.2 | 1.4 | | | | | | | | | | |
| 78 | | 1.2 | | | | | | | | | | |

51505/25/45/65

固定式ジブ定格総荷重表 TF

LTM 1400NX

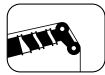

14.9m-69.1m



0°/20°/40°
42m

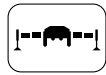

8.9m×8.53m

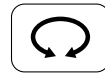

360°



100t

| メインブーム長さ ジブ長さ 作業半径(m) | 14.9m+2.5m 42m | | | 40.3m+2.5m 42m | | | 45.3m+2.5m 42m | | | 50.4m+2.5m 42m | | | 55.5m+2.5m 42m | | |
|-----------------------------|-------------------|-----|-----|-------------------|-----|-----|-------------------|-----|-----|-------------------|-----|-----|-------------------|-----|-----|
| | 0° | 20° | 40° | 0° | 20° | 40° | 0° | 20° | 40° | 0° | 20° | 40° | 0° | 20° | 40° |
| 10 | 8.5 | | | | | | | | | | | | | | |
| 11 | 8.3 | | | | | | | | | | | | | | |
| 12 | 8.0 | | | | | | | | | | | | | | |
| 13 | 7.7 | | | | | | | | | | | | | | |
| 14 | 7.4 | | | | | | | | | | | | | | |
| 16 | 6.8 | | | | 8.3 | | | | | | | | | | |
| 18 | 6.3 | | | | 7.8 | | | 7.5 | | | | | | | |
| 20 | 5.9 | | | | 7.4 | | | 7.1 | | | 6.6 | | | | |
| 22 | 5.4 | | | | 7.0 | | | 6.7 | | | 6.3 | | | 5.8 | |
| 24 | 5.0 | | | | 6.7 | | | 6.4 | | | 6.0 | | | 5.5 | |
| 26 | 4.6 | 3.8 | | | 6.3 | | | 6.1 | | | 5.8 | | | 5.3 | |
| 28 | 4.2 | 3.5 | | | 6.0 | | | 5.8 | | | 5.5 | | | 5.1 | |
| 30 | 3.8 | 3.3 | | | 5.7 | | | 5.5 | | | 5.3 | | | 4.9 | |
| 32 | 3.5 | 3.0 | | | 5.4 | 3.8 | | 5.3 | 3.7 | | 5.1 | | | 4.7 | |
| 34 | 3.2 | 2.8 | | | 5.0 | 3.6 | | 5.0 | 3.5 | | 4.8 | 3.4 | | 4.5 | |
| 36 | 3.0 | 2.6 | 2.1 | | 4.8 | 3.4 | | 4.7 | 3.4 | | 4.6 | 3.3 | | 4.4 | 3.1 |
| 38 | 2.8 | 2.5 | 1.9 | | 4.5 | 3.2 | | 4.5 | 3.2 | | 4.4 | 3.1 | | 4.2 | 3.0 |
| 40 | 2.6 | 2.3 | 1.8 | | 4.2 | 3.1 | | 4.3 | 3.1 | | 4.2 | 3.0 | | 4.0 | 2.9 |
| 42 | 2.4 | 2.2 | 1.7 | | 4.0 | 2.9 | 2.1 | 4.0 | 2.9 | | 4.0 | 2.9 | | 3.8 | 2.8 |
| 44 | 2.2 | 2.0 | 1.6 | | 3.7 | 2.8 | 2.1 | 3.8 | 2.8 | 2.1 | 3.8 | 2.8 | 2.0 | 3.6 | 2.7 |
| 46 | 2.1 | 1.9 | 1.5 | | 3.5 | 2.7 | 2.0 | 3.6 | 2.7 | 2.0 | 3.6 | 2.7 | 2.0 | 3.5 | 2.6 |
| 48 | 1.9 | 1.8 | 1.4 | | 3.3 | 2.6 | 1.9 | 3.4 | 2.6 | 1.9 | 3.4 | 2.6 | 1.9 | 3.3 | 2.5 |
| 50 | 1.8 | 1.7 | 1.4 | | 3.1 | 2.4 | 1.8 | 3.2 | 2.5 | 1.9 | 3.3 | 2.5 | 1.9 | 3.2 | 2.4 |
| 52 | 1.7 | 1.6 | 1.4 | | 3.0 | 2.3 | 1.8 | 3.1 | 2.4 | 1.8 | 3.1 | 2.4 | 1.8 | 3.0 | 2.3 |
| 54 | 1.6 | 1.5 | 1.4 | | 2.8 | 2.3 | 1.7 | 2.9 | 2.3 | 1.7 | 3.0 | 2.3 | 1.8 | 2.9 | 2.2 |
| 56 | 1.5 | 1.5 | | | 2.7 | 2.2 | 1.7 | 2.8 | 2.2 | 1.7 | 2.8 | 2.2 | 1.7 | 2.7 | 2.2 |
| 58 | | | | | 2.6 | 2.1 | 1.6 | 2.7 | 2.1 | 1.7 | 2.7 | 2.1 | 1.7 | 2.6 | 2.1 |
| 60 | | | | | 2.4 | 2.0 | 1.6 | 2.5 | 2.0 | 1.6 | 2.6 | 2.1 | 1.6 | 2.4 | 2.0 |
| 62 | | | | | 2.3 | 1.9 | 1.6 | 2.4 | 2.0 | 1.6 | 2.5 | 2.0 | 1.6 | 2.2 | 2.0 |
| 64 | | | | | 2.2 | 1.9 | 1.6 | 2.3 | 1.9 | 1.6 | 2.4 | 1.9 | 1.6 | 2.0 | 1.9 |
| 66 | | | | | 2.1 | 1.8 | 1.5 | 2.2 | 1.8 | 1.5 | 2.2 | 1.9 | 1.5 | 1.8 | 1.8 |
| 68 | | | | | 2.0 | 1.7 | | 2.1 | 1.8 | 1.5 | 2.1 | 1.8 | 1.5 | 1.6 | 1.8 |
| 70 | | | | | 1.9 | 1.7 | | 2.0 | 1.7 | 1.5 | 2.0 | 1.8 | 1.5 | 1.4 | 1.7 |
| 72 | | | | | 1.8 | 1.6 | | 1.9 | 1.7 | | 1.8 | 1.7 | 1.5 | | 1.6 |
| 74 | | | | | 1.7 | 1.6 | | 1.8 | 1.6 | | 1.6 | 1.7 | 1.5 | | 1.5 |
| 76 | | | | | 1.6 | 1.5 | | 1.8 | 1.6 | | 1.4 | 1.6 | | | 1.5 |
| 78 | | | | | 1.6 | | | 1.7 | 1.5 | | 1.2 | 1.5 | | | 1.3 |
| 80 | | | | | 1.5 | | | 1.6 | 1.5 | | | 1.4 | | | |
| 82 | | | | | | | | 1.6 | | | | 1.2 | | | |
| 84 | | | | | | | | 1.5 | | | | | | | |

| メインブーム長さ ジブ長さ 作業半径(m) | 59.0m+2.5m 42m | | 60.5m+2.5m 42m | | | 64.0m+2.5m 42m | | 65.6m+2.5m 42m | | 69.1m+2.5m 42m | |
|-----------------------------|-------------------|-----|-------------------|-----|-----|-------------------|-----|-------------------|-----|-------------------|-----|
| | 0° | 20° | 0° | 20° | 40° | 0° | 20° | 0° | 20° | 0° | 20° |
| 24 | 3.9 | | 4.9 | | | | | | | | |
| 26 | 3.7 | | 4.7 | | | 3.3 | | 3.2 | | 1.6 | |
| 28 | 3.5 | | 4.6 | | | 3.3 | | 3.2 | | 1.6 | |
| 30 | 3.4 | | 4.4 | | | 3.2 | | 3.1 | | 1.6 | |
| 32 | 3.2 | | 4.2 | | | 3.0 | | 3.0 | | 1.6 | |
| 34 | 3.1 | | 4.1 | | | 2.9 | | 3.0 | | 1.6 | |
| 36 | 2.9 | | 3.9 | | | 2.8 | | 2.9 | | 1.6 | |
| 38 | 2.7 | | 3.8 | | | 2.6 | | 2.8 | | 1.6 | |
| 40 | 2.5 | | 3.6 | 2.7 | | 2.4 | | 2.7 | | 1.5 | |
| 42 | 2.3 | 2.1 | 3.5 | 2.6 | | 2.2 | 2.0 | 2.6 | | 1.5 | |
| 44 | 2.1 | 2.0 | 3.4 | 2.6 | | 2.0 | 1.9 | 2.5 | 2.1 | 1.4 | |
| 46 | 1.8 | 1.9 | 3.2 | 2.5 | | 1.7 | 1.8 | 2.4 | 2.0 | 1.3 | 1.7 |
| 48 | 1.5 | 1.8 | 3.1 | 2.4 | | 1.4 | 1.7 | 2.2 | 1.9 | | 1.6 |
| 50 | 1.2 | 1.7 | 2.9 | 2.3 | | 1.2 | 1.6 | 2.1 | 1.9 | | 1.5 |
| 52 | | 1.6 | 2.7 | 2.2 | 1.7 | | 1.5 | 2.0 | 1.8 | | 1.4 |
| 54 | | 1.5 | 2.5 | 2.2 | 1.7 | | 1.4 | 1.9 | 1.7 | | 1.4 |
| 56 | | 1.3 | 2.3 | 2.1 | 1.7 | | 1.3 | 1.7 | 1.6 | | |
| 58 | | | 2.1 | 2.0 | 1.6 | | | 1.6 | 1.6 | | |
| 60 | | | 1.9 | 2.0 | 1.6 | | | 1.4 | 1.5 | | |
| 62 | | | 1.7 | 1.9 | 1.6 | | | 1.2 | 1.4 | | |
| 64 | | | 1.5 | 1.9 | 1.5 | | | | 1.3 | | |
| 66 | | | 1.2 | 1.8 | 1.5 | | | | 1.2 | | |
| 68 | | | | 1.6 | 1.5 | | | | | | |
| 70 | | | | 1.4 | 1.5 | | | | | | |
| 72 | | | | 1.2 | 1.5 | | | | | | |
| 74 | | | | | 1.4 | | | | | | |
| 76 | | | | | 1.2 | | | | | | |

51705/25/45

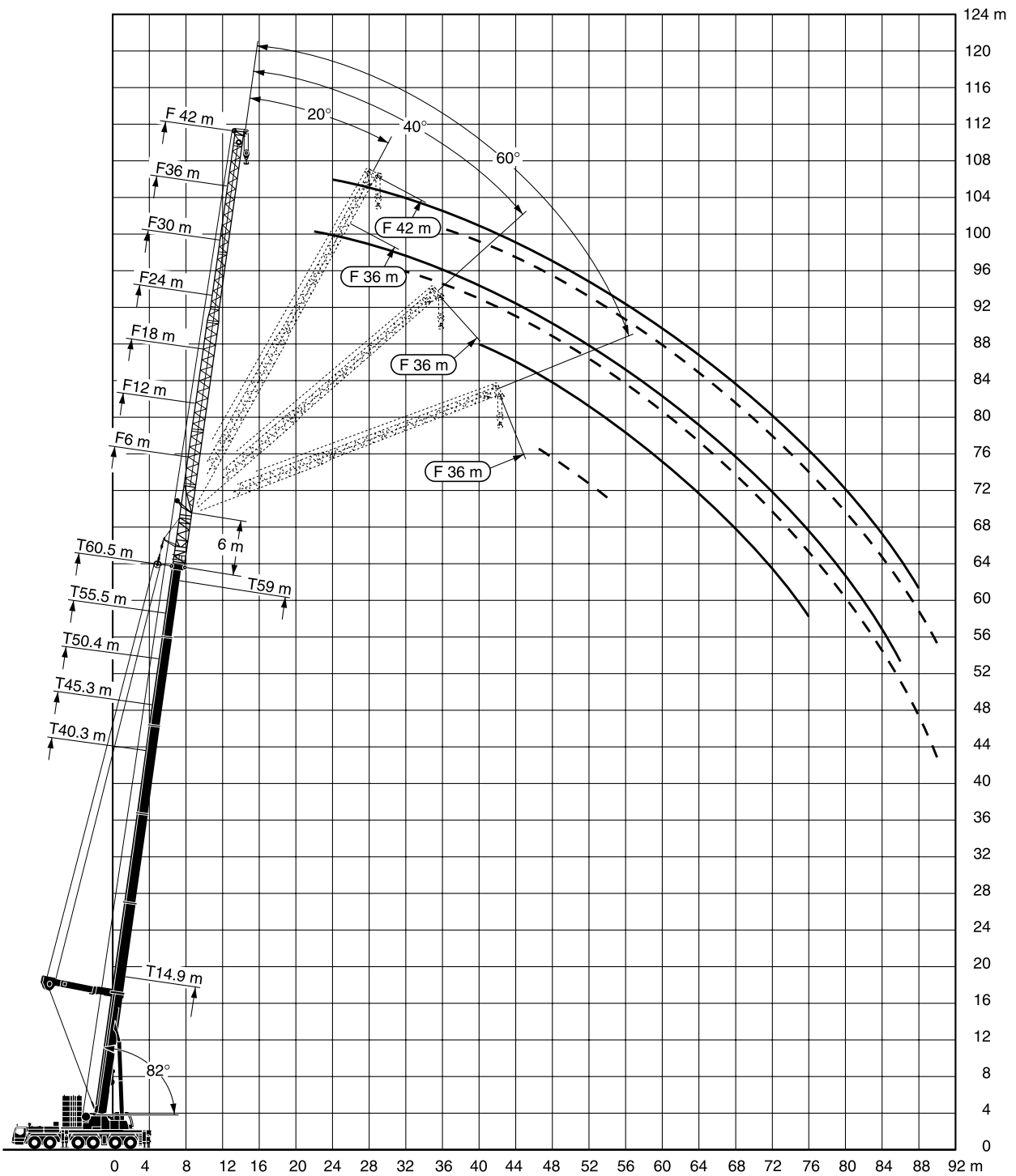

注意

- 1 定格総荷重はフックブロック、玉掛ワイヤー等の自重を含みます。
また、下記の条件が考慮されていないのでクレーンの操作には充分気をつけてください。
 - ① 地盤の強度、地震による影響
 - ② 作業速度に応じた動荷重および台風または強風による影響等
- 2 本機は水平に設置して、クレーン作業を行ってください。
- 3 作業半径は、クレーンの旋回中心から荷重の重心までの水平距離です。
- 4 メインブームの定格総荷重は補助ジブを取り除いた状態での値です。
- 5 メインブーム70m仕様で200トンを超える定格総荷重の場合は、特殊吊装置が必要です。

固定式ジブ (ガイ、エクセンダー仕様) 定格総荷重表 TYVEF

LTM 1400NX

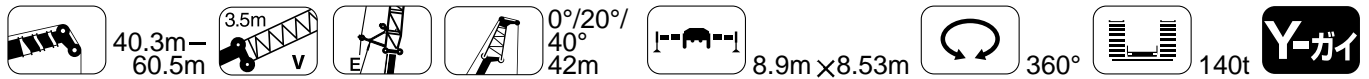

| メインブーム長さ ジブ長さ 作業半径(m) | 40.3m+6m 42m | | | 45.3m+6m 42m | | | 50.4m+6m 42m | | | 55.5m+6m 42m | | | 60.5m+6m 42m | |
|-----------------------------|-----------------|-----|-----|-----------------|-----|-----|-----------------|-----|-----|-----------------|-----|-----|-----------------|-----|
| | 0° | 20° | 40° | 0° | 20° | 40° | 0° | 20° | 40° | 0° | 20° | 40° | 0° | 20° |
| 16 | 9.9 | | | | | | | | | | | | | |
| 18 | 9.3 | | | 9.3 | | | 9.2 | | | 9.1 | | | | |
| 20 | 8.7 | | | 8.7 | | | 8.7 | | | 8.7 | | | | |
| 22 | 8.2 | | | 8.2 | | | 8.3 | | | 8.3 | | | 8.0 | |
| 24 | 7.7 | | | 7.8 | | | 7.8 | | | 7.8 | | | 7.7 | |
| 26 | 7.3 | | | 7.4 | | | 7.4 | | | 7.4 | | | 7.3 | |
| 28 | 6.9 | | | 7.0 | | | 7.1 | | | 7.1 | | | 7.0 | |
| 30 | 6.5 | 4.4 | | 6.6 | | | 6.7 | | | 6.8 | | | 6.7 | |
| 32 | 6.2 | 4.2 | | 6.3 | 4.2 | | 6.4 | 4.3 | | 6.4 | | | 6.4 | |
| 34 | 5.9 | 4.0 | | 6.0 | 4.0 | | 6.1 | 4.1 | | 6.2 | 4.1 | | 6.1 | |
| 36 | 5.6 | 3.8 | | 5.7 | 3.8 | | 5.8 | 3.9 | | 5.9 | 3.9 | | 5.8 | 3.9 |
| 38 | 5.3 | 3.6 | | 5.4 | 3.6 | | 5.6 | 3.7 | | 5.6 | 3.8 | | 5.6 | 3.8 |
| 40 | 5.0 | 3.4 | 2.4 | 5.2 | 3.5 | | 5.3 | 3.5 | | 5.4 | 3.6 | | 5.4 | 3.6 |
| 42 | 4.7 | 3.2 | 2.3 | 4.9 | 3.3 | 2.3 | 5.1 | 3.4 | 2.3 | 5.2 | 3.4 | | 5.2 | 3.4 |
| 44 | 4.4 | 3.1 | 2.2 | 4.7 | 3.2 | 2.2 | 4.8 | 3.2 | 2.2 | 4.9 | 3.3 | 2.3 | 4.9 | 3.3 |
| 46 | 4.2 | 2.9 | 2.1 | 4.4 | 3.0 | 2.1 | 4.6 | 3.1 | 2.2 | 4.7 | 3.2 | 2.2 | 4.8 | 3.2 |
| 48 | 3.9 | 2.8 | 2.0 | 4.2 | 2.9 | 2.1 | 4.4 | 3.0 | 2.1 | 4.5 | 3.1 | 2.1 | 4.6 | 3.1 |
| 50 | 3.7 | 2.7 | 2.0 | 4.0 | 2.8 | 2.0 | 4.2 | 2.9 | 2.0 | 4.3 | 2.9 | 2.1 | 4.4 | 3.0 |
| 52 | 3.5 | 2.6 | 1.9 | 3.8 | 2.7 | 1.9 | 4.0 | 2.8 | 2.0 | 4.2 | 2.8 | 2.0 | 4.2 | 2.9 |
| 54 | 3.3 | 2.5 | 1.8 | 3.6 | 2.6 | 1.9 | 3.8 | 2.7 | 1.9 | 4.0 | 2.7 | 1.9 | 4.0 | 2.8 |
| 56 | 3.2 | 2.4 | 1.8 | 3.4 | 2.5 | 1.8 | 3.6 | 2.6 | 1.9 | 3.8 | 2.6 | 1.9 | 3.9 | 2.7 |
| 58 | 3.0 | 2.3 | 1.7 | 3.2 | 2.4 | 1.8 | 3.4 | 2.5 | 1.8 | 3.6 | 2.5 | 1.8 | 3.7 | 2.6 |
| 60 | 2.8 | 2.2 | 1.7 | 3.1 | 2.3 | 1.7 | 3.3 | 2.4 | 1.8 | 3.5 | 2.4 | 1.8 | 3.5 | 2.5 |
| 62 | 2.7 | 2.1 | 1.7 | 2.9 | 2.2 | 1.7 | 3.1 | 2.3 | 1.7 | 3.3 | 2.4 | 1.8 | 3.4 | 2.4 |
| 64 | 2.5 | 2.0 | 1.6 | 2.8 | 2.1 | 1.6 | 3.0 | 2.2 | 1.7 | 3.1 | 2.3 | 1.7 | 3.3 | 2.3 |
| 66 | 2.4 | 2.0 | 1.6 | 2.6 | 2.1 | 1.6 | 2.9 | 2.1 | 1.6 | 3.0 | 2.2 | 1.7 | 3.1 | 2.3 |
| 68 | 2.3 | 1.9 | 1.6 | 2.5 | 2.0 | 1.6 | 2.7 | 2.1 | 1.6 | 2.9 | 2.1 | 1.6 | 3.0 | 2.2 |
| 70 | 2.2 | 1.8 | | 2.4 | 1.9 | 1.6 | 2.6 | 2.0 | 1.6 | 2.8 | 2.1 | 1.6 | 2.9 | 2.1 |
| 72 | 2.1 | 1.8 | | 2.3 | 1.9 | | 2.5 | 1.9 | 1.6 | 2.7 | 2.0 | 1.6 | 2.8 | 2.0 |
| 74 | 2.0 | 1.7 | | 2.2 | 1.8 | | 2.4 | 1.9 | 1.5 | 2.5 | 1.9 | 1.6 | 2.7 | 2.0 |
| 76 | 1.9 | 1.7 | | 2.1 | 1.8 | | 2.3 | 1.8 | | 2.4 | 1.9 | 1.5 | 2.6 | 1.9 |
| 78 | 1.8 | | | 2.0 | 1.7 | | 2.2 | 1.8 | | 2.3 | 1.8 | 1.5 | 2.4 | 1.9 |
| 80 | 1.7 | | | 1.9 | 1.7 | | 2.1 | 1.7 | | 2.2 | 1.8 | | 2.3 | 1.8 |
| 82 | 1.3 | | | 1.8 | 1.6 | | 2.0 | 1.7 | | 2.1 | 1.7 | | 2.2 | 1.8 |
| 84 | | | | 1.6 | | | 1.9 | 1.6 | | 2.0 | 1.7 | | 2.1 | 1.7 |
| 86 | | | | | | | 1.8 | 1.6 | | 2.0 | 1.7 | | 2.0 | 1.7 |
| 88 | | | | | | | 1.6 | | | 1.7 | 1.6 | | 1.7 | 1.7 |
| 90 | | | | | | | | | | 1.3 | 1.6 | | | 1.5 |
| 92 | | | | | | | | | | | 1.5 | | | |

61701/61721/61741

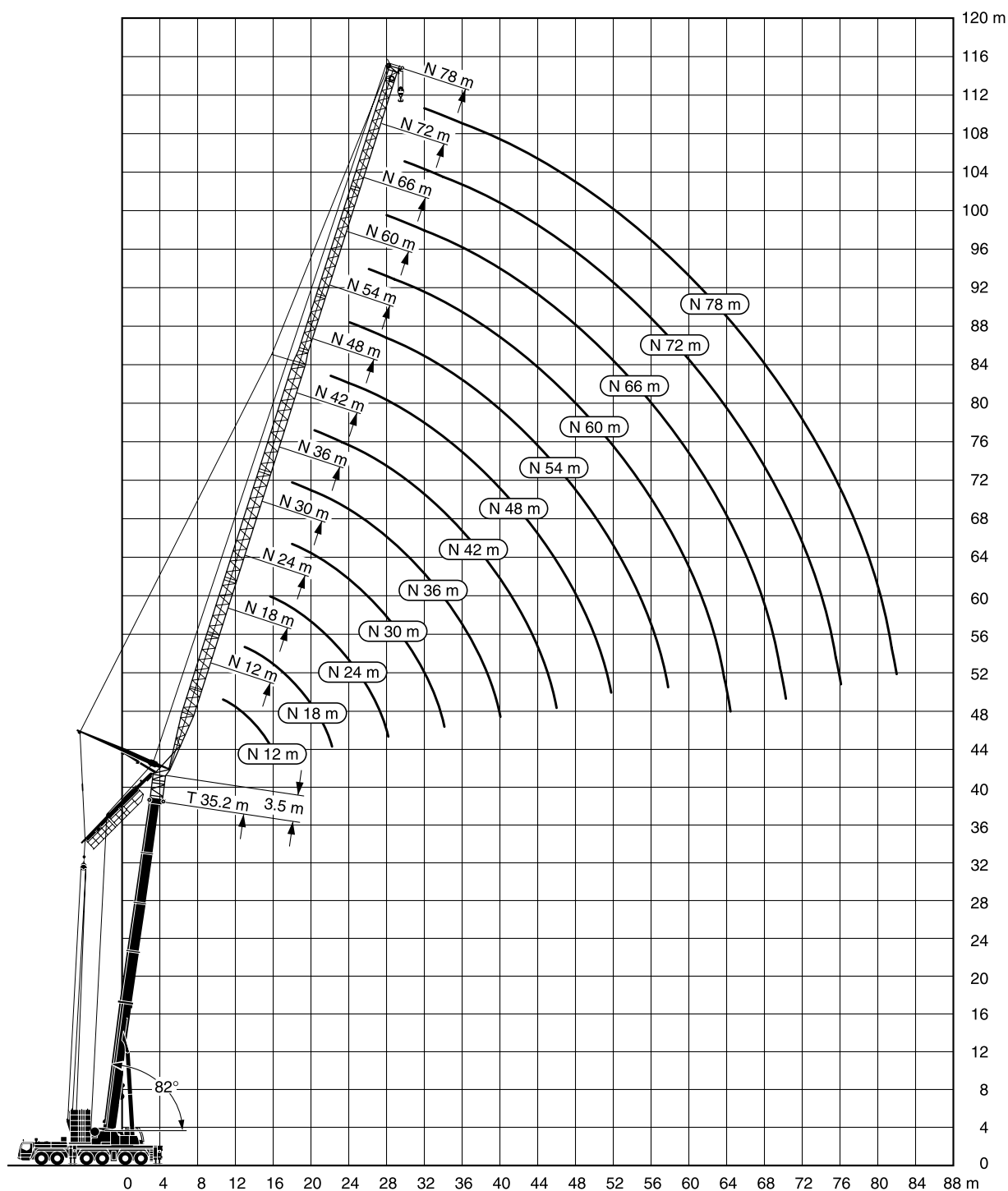

注意

- 1 定格総荷重はフックブロック、玉掛ワイヤー等の自重を含みます。
また、下記の条件が考慮されていないのでクレーンの操作には充分気をつけてください。
 - ① 地盤の強度、地震による影響
 - ② 作業速度に応じた動荷重および台風または強風による影響等
- 2 本機は水平に設置して、クレーン作業を行ってください。
- 3 作業半径は、クレーンの旋回中心から荷重の重心までの水平距離です。
- 4 メインブームの定格総荷重は補助ジブを取り除いた状態での値です。
- 5 メインブーム70m仕様で200トンを超える定格総荷重の場合は、特殊吊装置が必要です。

起伏式ジブ定格総荷重表 TN

LTM 1400NX



14.9m-45.3m

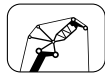

82°/75°/68°
12m

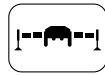

8.9m x 8.53m

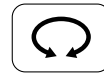

360°

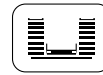

100t

| メイン長さ | 14.9m+3.5m | | | 20.0m+3.5m | | | 25.0m+3.5m | | | 30.1m+3.5m | | | 35.2m+3.5m | | | 40.3m+3.5m | | | 45.3m+3.5m | | |
|-------|------------|------|------|------------|------|------|------------|------|-----|------------|------|------|------------|------|-----|------------|------|-----|------------|-----|------|
| ジブ長さ | 12m | | | 12m | | | 12m | | | 12m | | | 12m | | | 12m | | | 12m | | |
| 角度 | 82° | 75° | 68° | 82° | 75° | 68° | 82° | 75° | 68° | 82° | 75° | 68° | 82° | 75° | 68° | 82° | 75° | 68° | 82° | 75° | |
| 7 | 70.8 | | | | | | | | | | | | | | | | | | | | |
| 8 | 70.8 | | | 70.8 | | | | | | | | | | | | | | | | | |
| 9 | 70.8 | | | 70.8 | | | 64.4 | | | | | | | | | | | | | | |
| 10 | 69.3 | | | 69.9 | | | 65.1 | | | 53.2 | | | | | | | | | | | |
| 11 | 66.0 | 67.0 | | 68.4 | | | 64.9 | | | 53.5 | | | 44.7 | | | | | | | | |
| 12 | 61.5 | 62.6 | | 65.7 | 67.8 | | 63.7 | | | 53.6 | | | 44.7 | | | 34.0 | | | | | |
| 13 | 55.0 | 59.4 | | 60.3 | 65.1 | | 62.9 | | | 53.9 | | | 44.8 | | | 34.0 | | | | | 26.3 |
| 14 | 49.1 | 56.9 | 58.1 | 53.9 | 62.0 | | 59.4 | 61.7 | | 54.4 | | | 45.0 | | | 34.0 | | | | | 26.2 |
| 16 | | 50.5 | 51.8 | | 57.0 | 56.4 | | 57.3 | | 53.9 | 51.8 | | 45.8 | | | 33.6 | | | | | 26.2 |
| 18 | | | 49.5 | | | 50.2 | | 50.9 | | | 49.2 | | | 42.6 | | | | | | | 26.2 |
| 20 | | | | | | 45.0 | | | | 43.2 | | | 44.1 | | | | | | 28.0 | | |
| 22 | | | | | | | | | | 39.2 | | | | | | | | | 26.1 | | |
| 24 | | | | | | | | | | | | 37.2 | | | | | | | | | 22.1 |
| 26 | | | | | | | | | | | | 34.0 | | | | | 32.8 | | | | 20.8 |
| 28 | | | | | | | | | | | | | | | | | 30.0 | | | | 19.2 |

54105



14.9m-65.6m



82°/75°/68°
18m



8.9m x 8.53m



360°



100t

| メイン長さ | 14.9m+3.5m | | 20.0m+3.5m | | 25.0m+3.5m | | 30.1m+3.5m | | 35.2m+3.5m | | 40.3m+3.5m | | 45.3m+3.5m | | 50.4m+3.5m | | 55.5m+3.5m | | 60.5m+3.5m | | 65.6m+3.5m | | |
|-------|------------|------|------------|------|------------|------|------------|------|------------|------|------------|-----|------------|------|------------|------|------------|------|------------|------|------------|------|-----|
| ジブ長さ | 18m | | 18m | | 18m | | 18m | | 18m | | 18m | | 18m | | 18m | | 18m | | 18m | | 18m | | |
| 角度 | 82° | 75° | 68° | 82° | 75° | 68° | 82° | 75° | 68° | 82° | 75° | 68° | 82° | 75° | 68° | 82° | 75° | 68° | 82° | 75° | 68° | 82° | 75° |
| 9 | 59.2 | | | | | | | | | | | | | | | | | | | | | | |
| 10 | 57.9 | | | 55.3 | | | | | | | | | | | | | | | | | | | |
| 11 | 56.5 | | | 54.9 | | | 49.2 | | | | | | | | | | | | | | | | |
| 12 | 55.0 | | | 53.8 | | | 49.1 | | | 41.1 | | | | | | | | | | | | | |
| 13 | 53.7 | | | 52.7 | | | 49.1 | | | 41.1 | | | 34.9 | | | | | | | | | | |
| 14 | 52.5 | 52.4 | | 51.7 | | | 48.6 | | | 41.1 | | | 34.9 | | 27.1 | | | | | | | | |
| 16 | 50.6 | 49.1 | | 50.2 | 49.7 | | 47.5 | | | 41.1 | | | 34.9 | | 27.0 | | | 20.7 | | 15.7 | | | |
| 18 | 48.2 | 45.7 | 46.0 | 49.6 | 47.5 | | 46.9 | 45.7 | | 41.1 | 39.8 | | 34.9 | | 27.0 | | | 20.7 | | 15.6 | | | |
| 20 | 41.0 | 44.0 | 42.1 | 44.1 | 46.1 | 44.8 | 46.5 | 44.3 | | 41.1 | 40.0 | | 34.9 | 33.9 | 26.9 | | | 20.7 | | 15.6 | | | |
| 22 | | 42.3 | 39.8 | | 42.5 | 40.7 | | 41.3 | 38.9 | 41.1 | 39.5 | | 34.9 | 33.8 | 26.6 | 24.4 | | 20.7 | | 15.6 | | | |
| 24 | | | 38.5 | | | 37.2 | 37.7 | 35.6 | | 36.5 | 33.7 | | 33.6 | | 23.2 | | | 20.7 | 18.9 | 15.6 | | | |
| 26 | | | | | | 34.1 | | | | 32.7 | 33.5 | | 32.7 | | 22.0 | | | | 18.1 | | 14.0 | | |
| 28 | | | | | | | | 30.2 | | | | | | | | | | | | | | 10.2 | |
| 30 | | | | | | | | | | | | | | | 27.4 | 20.9 | | | | | | | |
| 32 | | | | | | | | | | | | | | | 25.2 | | | 17.6 | 16.6 | | | | |
| 34 | | | | | | | | | | | | | | | | | | | | | | 9.8 | |
| 36 | | | | | | | | | | | | | | | | | | | | | | 9.5 | |

54205

起伏式ジブ定格総荷重表 TN

LTM 1400NX



14.9m-65.6m



82°/75°/68°
24m



8.9m×8.53m



360°



100t

| メインブーム長さ ジブ長さ 角度 作業半径(m) | 14.9m+3.5m 24m | | | 20.0m+3.5m 24m | | | 25.0m+3.5m 24m | | | 30.1m+3.5m 24m | | | 35.2m+3.5m 24m | | | 40.3m+3.5m 24m | | |
|-----------------------------------|-------------------|------|------|-------------------|------|------|-------------------|------|------|-------------------|------|------|-------------------|------|------|-------------------|------|------|
| | 82° | 75° | 68° | 82° | 75° | 68° | 82° | 75° | 68° | 82° | 75° | 68° | 82° | 75° | 68° | 82° | 75° | 68° |
| 11 | 46.1 | | | | | | | | | | | | | | | | | |
| 12 | 45.1 | | | 42.9 | | | | | | | | | | | | | | |
| 13 | 44.2 | | | 42.5 | | | 38.3 | | | | | | | | | | | |
| 14 | 43.3 | | | 41.9 | | | 38.3 | | | 32.5 | | | | | | | | |
| 16 | 41.7 | 41.7 | | 40.6 | | | 38.1 | | | 32.5 | | | 28.0 | | | 21.8 | | |
| 18 | 40.2 | 39.8 | | 39.6 | 39.4 | | 37.3 | | | 32.5 | | | 28.0 | | | 21.7 | | |
| 20 | 39.3 | 38.2 | | 38.8 | 38.0 | | 36.6 | 36.2 | | 32.5 | | | 28.2 | | | 21.6 | | |
| 22 | 39.1 | 36.8 | 36.6 | 38.5 | 36.8 | | 36.3 | 35.2 | | 32.5 | 31.6 | | 28.3 | | | 21.6 | | |
| 24 | 39.1 | 36.0 | 34.6 | 38.5 | 36.0 | 35.6 | 36.3 | 34.5 | | 32.5 | 31.2 | | 28.4 | 27.2 | | 21.6 | | |
| 26 | 30.1 | 35.6 | 32.9 | 36.8 | 35.5 | 33.9 | 36.3 | 34.0 | 32.4 | 32.5 | 30.9 | | 28.4 | 27.2 | | 21.5 | 20.0 | |
| 28 | | 33.6 | 32.1 | | 32.8 | 31.4 | | 31.9 | 30.0 | 32.5 | 30.7 | 28.2 | 28.4 | 27.1 | | 21.3 | 19.2 | |
| 30 | | | 30.2 | | | 29.1 | | 29.6 | 27.7 | | 28.5 | 26.0 | | 27.1 | 24.8 | | 18.4 | |
| 32 | | | | | | 27.0 | | | 25.7 | | 26.4 | 24.1 | | 25.6 | 22.9 | | 17.6 | 16.0 |
| 34 | | | | | | | | | 23.8 | | | 22.4 | | | 21.3 | | 17.0 | 15.0 |
| 36 | | | | | | | | | | | | 20.9 | | | 19.9 | | 14.2 | |
| 38 | | | | | | | | | | | | | | | 18.6 | | | 13.4 |

| メインブーム長さ ジブ長さ 角度 作業半径(m) | 45.3m+3.5m 24m | | | 50.4m+3.5m 24m | | | 55.5m+3.5m 24m | | | 60.5m+3.5m 24m | | | 65.6m+3.5m 24m | |
|-----------------------------------|-------------------|------|------|-------------------|------|-----|-------------------|-----|-----|-------------------|-----|-----|-------------------|-----|
| | 82° | 75° | 68° | 82° | 75° | 68° | 82° | 75° | 68° | 82° | 75° | 68° | 82° | 75° |
| 18 | 16.6 | | | 12.2 | | | | | | | | | | |
| 20 | 16.5 | | | 12.2 | | | 9.0 | | | 6.3 | | | | |
| 22 | 16.5 | | | 12.2 | | | 9.0 | | | 6.2 | | | 3.4 | |
| 24 | 16.5 | | | 12.2 | | | 8.9 | | | 6.1 | | | 3.4 | |
| 26 | 16.5 | 15.8 | | 12.2 | | | 8.9 | | | 6.1 | | | 3.4 | |
| 28 | 16.5 | 15.5 | | 12.2 | | | 8.9 | | | 6.0 | | | 3.3 | |
| 30 | 16.5 | 15.0 | | 12.2 | 11.2 | | 8.9 | | | 6.0 | | | 3.3 | |
| 32 | | 14.4 | | | 10.8 | | | 8.0 | | 6.0 | | | 3.3 | |
| 34 | | 14.0 | | | 10.5 | | | 7.8 | | | 5.3 | | | |
| 36 | | 13.6 | 11.9 | | 10.2 | | | 7.5 | | | 5.3 | | | 2.7 |
| 38 | | | 11.2 | | | 8.3 | | 7.3 | | | 5.2 | | | 2.7 |
| 40 | | | 10.7 | | | 7.8 | | | | | 5.1 | | | 2.7 |
| 42 | | | | | | 7.4 | | | 5.3 | | | | | |
| 44 | | | | | | | | | 5.0 | | | 3.3 | | |
| 46 | | | | | | | | | | | | 3.2 | | |

54305

起伏式ジブ定格総荷重表 TN

LTM 1400NX



14.9m-65.6m

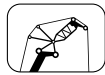

82°/75°/68°
30m

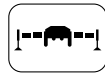

8.9m×8.53m

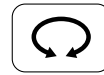

360°

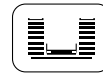

100t

| メインブーム長さ ジブ長さ | 14.9m+3.5m 30m | | | 20.0m+3.5m 30m | | | 25.0m+3.5m 30m | | | 30.1m+3.5m 30m | | | 35.2m+3.5m 30m | | | 40.3m+3.5m 30m | | |
|------------------|-------------------|------|------|-------------------|------|------|-------------------|------|------|-------------------|------|------|-------------------|------|------|-------------------|------|------|
| 角度 | 82° | 75° | 68° | 82° | 75° | 68° | 82° | 75° | 68° | 82° | 75° | 68° | 82° | 75° | 68° | 82° | 75° | 68° |
| 作業半径(m) | | | | | | | | | | | | | | | | | | |
| 13 | 35.7 | | | | | | | | | | | | | | | | | |
| 14 | 35.1 | | | 33.2 | | | | | | | | | | | | | | |
| 16 | 34.2 | | | 32.9 | | | 29.8 | | | 25.8 | | | | | | | | |
| 18 | 33.2 | | | 32.2 | | | 29.8 | | | 25.7 | | | 22.3 | | | | 17.7 | |
| 20 | 32.4 | 31.9 | | 31.5 | 31.2 | | 29.5 | | | 25.5 | | | 22.2 | | | | 17.6 | |
| 22 | 31.7 | 30.9 | | 31.0 | 30.3 | | 29.2 | 28.7 | | 25.5 | | | 22.2 | | | | 17.5 | |
| 24 | 31.3 | 30.1 | 29.8 | 30.6 | 29.6 | | 28.8 | 28.1 | | 25.5 | 24.8 | | 22.2 | | | | 17.4 | |
| 26 | 31.2 | 29.4 | 28.8 | 30.5 | 29.1 | 28.7 | 28.7 | 27.6 | | 25.5 | 24.8 | | 22.2 | 21.4 | | | 17.4 | |
| 28 | 31.2 | 29.0 | 28.0 | 30.5 | 28.6 | 27.9 | 28.7 | 27.2 | 26.9 | 25.5 | 24.7 | | 22.2 | 21.4 | | | 17.4 | 16.7 |
| 30 | 27.9 | 29.0 | 27.3 | 30.5 | 28.5 | 27.3 | 28.7 | 27.0 | 26.3 | 25.5 | 24.5 | | 22.2 | 21.4 | | | 17.4 | 16.3 |
| 32 | 20.9 | 29.0 | 27.1 | 25.9 | 28.2 | 26.7 | 28.7 | 26.9 | 25.4 | 25.5 | 24.4 | 23.7 | 22.2 | 21.4 | | | 17.4 | 15.9 |
| 34 | | 24.2 | 26.0 | | 26.3 | 24.9 | | 25.4 | 23.6 | 25.5 | 24.3 | 22.0 | 22.2 | 21.4 | 20.7 | | 17.4 | 15.4 |
| 36 | | | 24.2 | | | 23.2 | | 23.7 | 22.0 | | 22.7 | 20.5 | | 21.4 | 19.6 | | 14.9 | 13.3 |
| 38 | | | | | | 21.7 | | | 20.6 | | 21.2 | 19.2 | | 20.6 | 18.4 | | 14.5 | 12.6 |
| 40 | | | | | | | | | 19.3 | | | 18.0 | | | 17.2 | | 14.1 | 12.0 |
| 42 | | | | | | | | | | | | 16.9 | | | 16.2 | | | 11.5 |
| 44 | | | | | | | | | | | | | | | 15.2 | | | 11.0 |

| メインブーム長さ ジブ長さ | 45.3m+3.5m 30m | | | 50.4m+3.5m 30m | | | 55.5m+3.5m 30m | | | 60.5m+3.5m 30m | | | 65.6+3.5 30m |
|------------------|-------------------|------|------|-------------------|-----|-----|-------------------|-----|-----|-------------------|-----|-----|-----------------|
| 角度 | 82° | 75° | 68° | 82° | 75° | 68° | 82° | 75° | 68° | 82° | 75° | 68° | 82° |
| 作業半径(m) | | | | | | | | | | | | | |
| 20 | 13.1 | | | 10.1 | | | | | | | | | |
| 22 | 13.1 | | | 10.0 | | | 7.1 | | | 4.3 | | | |
| 24 | 13.0 | | | 9.9 | | | 7.1 | | | 4.2 | | | 1.8 |
| 26 | 13.0 | | | 9.9 | | | 7.0 | | | 4.1 | | | 1.8 |
| 28 | 13.0 | | | 9.8 | | | 7.0 | | | 4.1 | | | 1.8 |
| 30 | 13.0 | 12.6 | | 9.8 | | | 6.9 | | | 4.0 | | | 1.7 |
| 32 | 13.0 | 12.5 | | 9.8 | 9.3 | | 6.9 | | | 4.0 | | | 1.7 |
| 34 | 13.0 | 12.3 | | 9.8 | 9.1 | | 6.9 | 6.3 | | 4.0 | | | 1.7 |
| 36 | 13.0 | 11.9 | | 9.8 | 8.8 | | 6.9 | 6.2 | | 4.0 | 3.4 | | 1.7 |
| 38 | | 11.6 | 10.3 | | 8.6 | | | 6.2 | | 4.0 | 3.4 | | 1.7 |
| 40 | | 11.3 | 9.8 | | 8.3 | | | 6.0 | | | 3.4 | | |
| 42 | | 11.1 | 9.4 | | 8.1 | 6.7 | | 5.8 | | | 3.3 | | |
| 44 | | | 8.9 | | | 6.4 | | 5.7 | 4.4 | | 3.3 | | |
| 46 | | | 8.6 | | | 6.1 | | | 4.1 | | 3.3 | | |
| 48 | | | | | | 5.8 | | | 3.9 | | | 2.5 | |
| 50 | | | | | | | | | 3.7 | | | 2.4 | |
| 52 | | | | | | | | | | | | 2.2 | |

54405

起伏式ジブ定格総荷重表 TN

LTM 1400NX

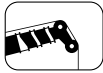

14.9m-60.5m

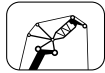

82°/75°/68°
36m

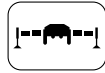

8.9m×8.53m



360°

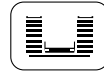

100t

| メインブーム長さ ジブ長さ 作業半径(m) | 14.9m+3.5m 36m | | | 20.0m+3.5m 36m | | | 25.0m+3.5m 36m | | | 30.1m+3.5m 36m | | | 35.2m+3.5m 36m | | |
|-----------------------------|-------------------|------|------|-------------------|------|------|-------------------|------|------|-------------------|------|------|-------------------|------|------|
| | 82° | 75° | 68° | 82° | 75° | 68° | 82° | 75° | 68° | 82° | 75° | 68° | 82° | 75° | 68° |
| 16 | 28.0 | | | 26.1 | | | | | | | | | | | |
| 18 | 27.4 | | | 25.9 | | | 23.6 | | | 20.6 | | | 18.1 | | |
| 20 | 26.8 | | | 25.8 | | | 23.4 | | | 20.5 | | | 17.9 | | |
| 22 | 26.2 | 25.9 | | 25.4 | | | 23.3 | | | 20.4 | | | 17.8 | | |
| 24 | 25.7 | 25.2 | | 25.0 | 24.6 | | 23.3 | 22.8 | | 20.3 | | | 17.8 | | |
| 26 | 25.2 | 24.6 | | 24.6 | 24.1 | | 23.2 | 22.7 | | 20.3 | 19.7 | | 17.8 | | |
| 28 | 24.9 | 24.1 | 23.8 | 24.4 | 23.6 | | 23.0 | 22.4 | | 20.3 | 19.6 | | 17.8 | 17.2 | |
| 30 | 24.2 | 23.6 | 23.1 | 24.1 | 23.3 | 23.0 | 22.7 | 22.1 | | 20.3 | 19.6 | | 17.8 | 17.2 | |
| 32 | 23.3 | 23.3 | 22.6 | 23.2 | 22.9 | 22.4 | 22.1 | 21.8 | 21.5 | 20.3 | 19.6 | | 17.8 | 17.1 | |
| 34 | 22.3 | 22.8 | 22.1 | 22.3 | 22.8 | 22.0 | 21.3 | 21.6 | 21.1 | 20.2 | 19.6 | 19.2 | 17.8 | 17.1 | |
| 36 | 21.3 | 22.2 | 21.9 | 21.4 | 22.2 | 21.7 | 20.5 | 21.5 | 20.7 | 19.9 | 19.6 | 19.0 | 17.8 | 17.1 | 16.7 |
| 38 | | 21.3 | 21.7 | 20.7 | 21.5 | 21.5 | 19.8 | 20.8 | 20.4 | 19.3 | 19.6 | 18.8 | 17.8 | 17.1 | 16.8 |
| 40 | | 19.9 | 21.1 | | 20.7 | 20.2 | | 20.1 | 19.2 | 19.0 | 19.5 | 17.8 | 17.8 | 17.1 | 16.9 |
| 42 | | | 19.9 | | | 19.0 | | 19.5 | 18.0 | | 18.6 | 16.8 | | 17.1 | 15.9 |
| 44 | | | | | | 17.9 | | | 17.0 | | 17.5 | 15.8 | | 16.9 | 14.9 |
| 46 | | | | | | | | | 16.0 | | | 14.9 | | | 14.1 |
| 48 | | | | | | | | | | | | 14.1 | | | 13.3 |
| 50 | | | | | | | | | | | | | | | 12.6 |

| メインブーム長さ ジブ長さ 作業半径(m) | 40.3m+3.5m 36m | | | 45.3m+3.5m 36m | | | 50.4m+3.5m 36m | | | 55.5m+3.5m 36m | | | 60.5m+3.5m 36m | | |
|-----------------------------|-------------------|------|------|-------------------|------|-----|-------------------|-----|-----|-------------------|-----|-----|-------------------|-----|-----|
| | 82° | 75° | 68° | 82° | 75° | 68° | 82° | 75° | 68° | 82° | 75° | 68° | 82° | 75° | 68° |
| 20 | 14.4 | | | | | | | | | | | | | | |
| 22 | 14.3 | | | 10.5 | | | 8.1 | | | | | | | | |
| 24 | 14.3 | | | 10.4 | | | 8.0 | | | 5.2 | | | 2.7 | | |
| 26 | 14.2 | | | 10.4 | | | 8.0 | | | 5.1 | | | 2.6 | | |
| 28 | 14.2 | | | 10.3 | | | 8.0 | | | 5.1 | | | 2.5 | | |
| 30 | 14.2 | 13.7 | | 10.3 | | | 7.9 | | | 5.0 | | | 2.5 | | |
| 32 | 14.2 | 13.6 | | 10.3 | 10.0 | | 7.9 | | | 5.0 | | | 2.5 | | |
| 34 | 14.2 | 13.5 | | 10.3 | 10.0 | | 7.9 | 7.4 | | 4.9 | | | 2.4 | | |
| 36 | 14.2 | 13.2 | | 10.3 | 10.1 | | 7.9 | 7.3 | | 4.9 | 4.4 | | 2.4 | | |
| 38 | 14.2 | 13.0 | | 10.3 | 10.0 | | 7.9 | 7.3 | | 4.9 | 4.3 | | 2.4 | 1.9 | |
| 40 | 14.2 | 12.6 | 11.3 | 10.3 | 9.8 | | 7.9 | 7.2 | | 4.9 | 4.3 | | 2.4 | 1.9 | |
| 42 | | 12.3 | 10.8 | 10.3 | 9.6 | 8.5 | 7.9 | 7.0 | | 4.9 | 4.3 | | 2.4 | 1.9 | |
| 44 | | 12.0 | 10.3 | | 9.4 | 8.2 | | 6.9 | | | 4.3 | | 2.4 | 1.8 | |
| 46 | | 11.8 | 9.9 | | 9.2 | 7.8 | | 6.7 | 5.5 | | 4.3 | | | 1.8 | |
| 48 | | | 9.5 | | 9.1 | 7.5 | | 6.5 | 5.2 | | 4.3 | 3.4 | | 1.8 | |
| 50 | | | 9.1 | | | 7.2 | | | 5.0 | | 4.3 | 3.2 | | 1.8 | |
| 52 | | | | | | 7.0 | | | 4.7 | | | 3.0 | | 1.8 | 1.6 |
| 54 | | | | | | | | | 4.5 | | | 2.9 | | | 1.6 |
| 56 | | | | | | | | | | | | 2.7 | | | 1.6 |
| 58 | | | | | | | | | | | | | | | 1.4 |

54505

起伏式ジブ定格総荷重表 TN

LTM 1400NX



14.9m-35.2m

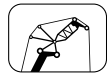

82°/75°/68°
78m

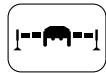

8.9m×8.53m



360°



100t

| メインブーム長さ ジブ長さ 角度 作業半径(m) | 14.9m+3.5m 78m | | | 20.0m+3.5m 78m | | | 25.0m+3.5m 78m | | | 30.1m+3.5m 78m | | | 35.2m+3.5m 78m | | |
|-----------------------------------|-------------------|-----|-----|-------------------|-----|-----|-------------------|-----|-----|-------------------|-----|-----|-------------------|-----|-----|
| | 82° | 75° | 68° | 82° | 75° | 68° | 82° | 75° | 68° | 82° | 75° | 68° | 82° | 75° | 68° |
| 28 | 5.7 | | | | | | | | | | | | | | |
| 30 | 5.7 | | | 5.3 | | | 4.9 | | | | | | | | |
| 32 | 5.6 | | | 5.3 | | | 4.9 | | | 4.0 | | | 3.0 | | |
| 34 | 5.6 | | | 5.3 | | | 4.8 | | | 3.9 | | | 2.9 | | |
| 36 | 5.5 | | | 5.2 | | | 4.8 | | | 3.9 | | | 2.8 | | |
| 38 | 5.4 | | | 5.1 | | | 4.7 | | | 3.8 | | | 2.7 | | |
| 40 | 5.3 | 5.1 | | 5.0 | | | 4.6 | | | 3.7 | | | 2.7 | | |
| 42 | 5.2 | 5.1 | | 5.0 | 4.8 | | 4.6 | 4.3 | | 3.6 | | | 2.6 | | |
| 44 | 5.2 | 5.1 | | 4.9 | 4.8 | | 4.5 | 4.3 | | 3.6 | 3.4 | | 2.6 | | |
| 46 | 5.1 | 5.0 | | 4.8 | 4.8 | | 4.5 | 4.3 | | 3.6 | 3.5 | | 2.6 | 2.4 | |
| 48 | 5.0 | 5.0 | | 4.8 | 4.7 | | 4.4 | 4.3 | | 3.6 | 3.5 | | 2.6 | 2.5 | |
| 50 | 5.0 | 4.9 | 4.5 | 4.7 | 4.7 | | 4.4 | 4.3 | | 3.6 | 3.5 | | 2.6 | 2.5 | |
| 52 | 4.9 | 4.8 | 4.6 | 4.7 | 4.6 | 4.2 | 4.3 | 4.2 | | 3.6 | 3.6 | | 2.6 | 2.5 | |
| 54 | 4.9 | 4.8 | 4.7 | 4.7 | 4.6 | 4.3 | 4.3 | 4.2 | 3.8 | 3.6 | 3.6 | | 2.6 | 2.6 | |
| 56 | 4.9 | 4.8 | 4.7 | 4.6 | 4.5 | 4.4 | 4.3 | 4.2 | | 3.6 | 3.5 | 3.3 | 2.6 | 2.6 | |
| 58 | 4.8 | 4.8 | 4.7 | 4.6 | 4.5 | 4.4 | 4.3 | 4.1 | 3.9 | 3.6 | 3.5 | 3.4 | 2.6 | 2.6 | |
| 60 | 4.8 | 4.7 | 4.7 | 4.6 | 4.4 | 4.3 | 4.3 | 4.1 | 3.9 | 3.6 | 3.5 | 3.4 | 2.6 | 2.6 | 2.5 |
| 62 | 4.8 | 4.7 | 4.6 | 4.6 | 4.4 | 4.3 | 4.2 | 4.0 | 3.9 | 3.6 | 3.5 | 3.4 | 2.6 | 2.7 | 2.6 |
| 64 | 4.8 | 4.7 | 4.5 | 4.6 | 4.4 | 4.3 | 4.2 | 4.0 | 3.9 | 3.6 | 3.5 | 3.4 | 2.6 | 2.7 | 2.6 |
| 66 | 4.8 | 4.6 | 4.4 | 4.6 | 4.4 | 4.3 | 4.2 | 4.0 | 3.9 | 3.6 | 3.5 | 3.4 | 2.6 | 2.7 | 2.7 |
| 68 | 4.8 | 4.6 | 4.4 | 4.6 | 4.4 | 4.3 | 4.2 | 4.0 | 3.9 | 3.6 | 3.5 | 3.4 | 2.6 | 2.7 | 2.6 |
| 70 | 4.7 | 4.6 | 4.4 | 4.5 | 4.4 | 4.3 | 4.2 | 4.0 | 3.9 | 3.6 | 3.5 | 3.4 | 2.6 | 2.6 | 2.6 |
| 72 | 4.7 | 4.6 | 4.4 | 4.5 | 4.4 | 4.3 | 4.2 | 4.0 | 3.9 | 3.6 | 3.5 | 3.3 | 2.6 | 2.6 | 2.6 |
| 74 | 4.7 | 4.6 | 4.4 | 4.5 | 4.4 | 4.3 | 4.2 | 4.0 | 3.9 | 3.6 | 3.5 | 3.3 | 2.6 | 2.6 | 2.6 |
| 76 | 4.7 | 4.6 | 4.4 | 4.5 | 4.4 | 4.3 | 4.2 | 4.0 | 3.9 | 3.6 | 3.5 | 3.3 | 2.6 | 2.6 | 2.6 |
| 78 | 4.7 | 4.6 | 4.4 | 4.5 | 4.4 | 4.3 | 4.2 | 4.0 | 3.9 | 3.6 | 3.5 | 3.3 | 2.6 | 2.6 | 2.6 |
| 80 | | 4.6 | 4.4 | | 4.4 | 4.3 | 4.2 | 4.0 | 3.9 | 3.6 | 3.5 | 3.3 | 2.6 | 2.6 | 2.6 |
| 82 | | 4.6 | 4.4 | | 4.4 | 4.3 | 4.2 | 4.0 | 3.9 | 3.6 | 3.5 | 3.3 | 2.6 | 2.6 | 2.6 |
| 84 | | | 4.4 | | | 4.3 | | 4.0 | 3.9 | | 3.5 | 3.3 | | 2.6 | 2.6 |
| 86 | | | | | | 4.3 | | | 3.9 | | 3.5 | 3.3 | | 2.6 | 2.6 |
| 88 | | | | | | | | | 3.9 | | | 3.3 | | | 2.6 |
| 90 | | | | | | | | | | | | | | | 2.6 |

55205

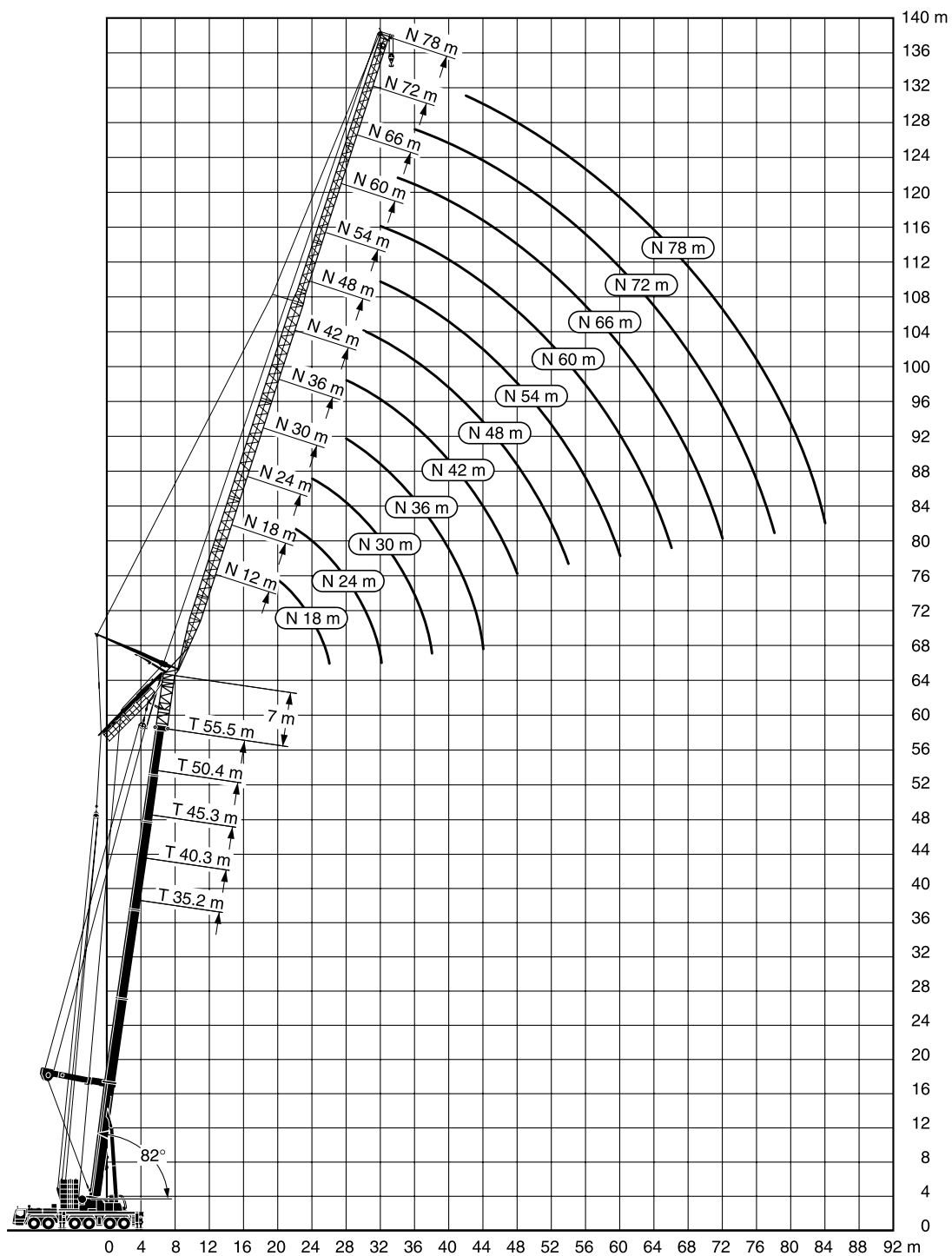

注意

- 1 定格総荷重はフックブロック、玉掛ワイヤー等の自重を含みます。
また、下記の条件が考慮されていませんのでクレーンの操作には充分気をつけてください。
① 地盤の強度、地震による影響
② 作業速度に応じた動荷重および台風または強風による影響等
- 2 本機は水平に設置して、クレーン作業を行ってください。
- 3 作業半径は、クレーンの旋回中心から荷重の重心までの水平距離です。
- 4 メインブームの定格総荷重は補助ジブを取り除いた状態での値です。
- 5 メインブーム70m仕様で200トンを超える定格総荷重の場合は、特殊吊装置が必要です。

起伏式ジブ(ガイ、エクセンダー仕様) 定格総荷重表 TYVEN LTM 1400NX



| メインブーム長さ | | 35.2m+7m | | | 40.3m+7m | | | 45.3m+7m | | |
|----------|--|----------|------|------|----------|------|------|----------|-----|------|
| ジブ長さ | | 12m | | | 12m | | | 12m | | |
| 角度 | | 82° | 75° | 68° | 82° | 75° | 68° | 82° | 75° | 68° |
| 作業半径(m) | | | | | | | | | | |
| 12 | | 55.1 | | | | | | | | |
| 13 | | 57.0 | | | | | | | | |
| 14 | | 56.0 | | | 49.9 | | | | | |
| 16 | | 51.6 | | | 48.8 | | | 44.1 | | |
| 18 | | | | | 45.2 | | | 43.0 | | |
| 20 | | | 45.1 | | | | | | | |
| 22 | | | 40.9 | | | | | | | |
| 24 | | | | | | 36.4 | | | | |
| 26 | | | | 30.7 | | | | | | |
| 28 | | | | | | | 23.0 | | | |
| 30 | | | | | | | | | | 18.5 |

64103



| メインブーム長さ | | 35.2m+7m | | | 40.3m+7m | | | 45.3m+7m | | | 50.4m+7m | | | 55.5m+7m | | | 60.5m+7m | | | 65.6m+7m | | |
|----------|--|----------|------|------|----------|-----|------|----------|-----|------|----------|-----|-----|----------|-----|-----|----------|-----|-----|----------|-----|------|
| ジブ長さ | | 18m | | | 18m | | | 18m | | | 18m | | | 18m | | | 18m | | | 18m | | |
| 角度 | | 82° | 75° | 68° | 82° | 75° | 68° | 82° | 75° | 68° | 82° | 75° | 68° | 82° | 75° | 68° | 82° | 75° | 68° | 82° | 75° | 68° |
| 作業半径(m) | | | | | | | | | | | | | | | | | | | | | | |
| 14 | | 37.8 | | | | | | | | | | | | | | | | | | | | |
| 16 | | 41.3 | | | | | | | | | | | | | | | | | | | | |
| 18 | | 44.1 | | | 40.2 | | | | | | | | | | | | | | | | | |
| 20 | | 44.2 | | | 41.0 | | | 37.1 | | | | | | | | | | | | | | |
| 22 | | 41.4 | | | 40.1 | | | 36.7 | | | | | | 28.1 | | | | | | 24.3 | | |
| 24 | | | 41.6 | | 37.5 | | | 36.0 | | | | | | 27.6 | | | | | | 23.8 | | 21.1 |
| 26 | | | 38.2 | | 35.1 | | 34.5 | 34.2 | | | | | | 27.1 | | | | | | 23.4 | | 20.7 |
| 28 | | | 35.2 | | | | 31.7 | | | 29.3 | | | | 26.5 | | | | | | 22.9 | | 20.1 |
| 30 | | | 32.6 | | | | 29.4 | | | 27.0 | | | | 26.4 | | | | | | | | |
| 32 | | | | 29.1 | | | | | | 25.1 | | | | 25.0 | | | | | | 24.0 | | |
| 34 | | | | 27.0 | | | | | | | | | | 23.8 | | | | | | 22.3 | | |
| 36 | | | | 25.2 | | | 20.5 | | | | | | | | | | | | | 18.4 | | |
| 38 | | | | | | | 19.0 | | | | | | | | | | | | | 17.8 | | |
| 40 | | | | | | | | | | | 16.7 | | | | | | | | | | | 15.6 |
| 42 | | | | | | | | | | | 15.5 | | | | | | | | | | | 14.9 |
| 44 | | | | | | | | | | | | | | | | | | | | | | 14.6 |
| | | | | | | | | | | | | | | | | | | | | | | 8.1 |
| | | | | | | | | | | | | | | | | | | | | | | 8.3 |
| | | | | | | | | | | | | | | | | | | | | | | 8.2 |

64202











| メインブーム長さ | | 35.2m+7m | | | 40.3m+7m | | | 45.3m+7m | | | 50.4m+7m | | | 55.5m+7m | | | 60.5m+7m | | | 65.6m+7m | | |
|----------|--|----------|------|------|----------|------|------|----------|-----|------|----------|-----|-----|----------|-----|-----|----------|-----|-----|----------|-----|------|
| ジブ長さ | | 24m | | | 24m | | | 24m | | | 24m | | | 24m | | | 24m | | | 24m | | |
| 角度 | | 82° | 75° | 68° | 82° | 75° | 68° | 82° | 75° | 68° | 82° | 75° | 68° | 82° | 75° | 68° | 82° | 75° | 68° | 82° | 75° | 68° |
| 作業半径(m) | | | | | | | | | | | | | | | | | | | | | | |
| 16 | | 31.1 | | | | | | | | | | | | | | | | | | | | |
| 18 | | 33.2 | | | 32.1 | | | | | | | | | | | | | | | | | |
| 20 | | 35.7 | | | 34.0 | | | 30.5 | | | | | | | | | | | | | | |
| 22 | | 36.6 | | | 33.6 | | | 30.7 | | | | | | | | | | | | | | |
| 24 | | 35.7 | 35.5 | | 32.4 | | | 30.2 | | | | | | | | | | | | | | |
| 26 | | 33.7 | 33.8 | | 30.6 | 30.0 | | 29.7 | | | | | | | | | | | | | | 18.2 |
| 28 | | 31.7 | 32.2 | | 28.9 | 28.6 | | 28.9 | | | | | | | | | | | | | | 17.8 |
| 30 | | | 30.6 | | 27.2 | 27.2 | | 27.4 | | | | | | | | | | | | | | 17.4 |
| 32 | | | 29.0 | 25.8 | | 25.9 | | | | 27.0 | | | | | | | | | | | | 16.9 |
| 34 | | | 27.2 | 24.2 | | 24.6 | | | | 25.7 | | | | | | | | | | | | 16.2 |
| 36 | | | | 22.8 | | | 22.1 | | | 24.3 | | | | | | | | | | | | 16.2 |
| 38 | | | | 21.5 | | | 20.5 | | | 22.8 | | | | | | | | | | | | 13.8 |
| 40 | | | | | | | 19.2 | | | | 16.6 | | | | | | | | | | | 13.1 |
| 42 | | | | | | | | | | | 15.5 | | | | | | | | | | | 12.6 |
| 44 | | | | | | | | | | | 14.5 | | | | | | | | | | | 12.0 |
| 46 | | | | | | | | | | | | | | | | | | | | | | 7.2 |
| 48 | | | | | | | | | | | | | | | | | | | | | | 7.2 |
| 50 | | | | | | | | | | | | | | | | | | | | | | 7.2 |

64301









起伏式ジブ (ガイ、エクセンダー仕様) 定格総荷重表 TYVEN

LTM 1400NX

 35.2m-65.6m
  3.5m
  E
 
 82°/75°/68° 30m
  8.9m x 8.53m
  360°
  140t
  Y-ガイ

| メインブーム長さ ジブ長さ 作業半径(m) | 35.2m+7m 30m | | | 40.3m+7m 30m | | | 45.3m+7m 30m | | | 50.4m+7m 30m | | | 55.5m+7m 30m | | | 60.5m+7m 30m | | | 65.6m+7m 30m | | | |
|-----------------------------|-----------------|------|------|-----------------|------|-----|-----------------|------|-----|-----------------|------|-----|-----------------|------|------|-----------------|------|-----|-----------------|------|-----|--|
| | 82° | 75° | 68° | 82° | 75° | 68° | 82° | 75° | 68° | 82° | 75° | 68° | 82° | 75° | 68° | 82° | 75° | 68° | 82° | 75° | 68° | |
| 18 | 26.5 | | | | | | | | | | | | | | | | | | | | | |
| 20 | 27.8 | | | 27.5 | | | | | | | | | | | | | | | | | | |
| 22 | 29.4 | | | 28.3 | | | 25.5 | | | 23.3 | | | | | | | | | | | | |
| 24 | 30.4 | | | 28.2 | | | 25.5 | | | 23.0 | | | 20.2 | | | 17.8 | | | | | | |
| 26 | 30.2 | | | 27.7 | | | 25.2 | | | 22.7 | | | 20.0 | | | 17.5 | | | | | | |
| 28 | 29.6 | 29.5 | | 27.0 | | | 24.8 | | | 22.3 | | | 19.6 | | | 17.2 | | | 15.4 | | | |
| 30 | 28.0 | 28.2 | | 25.5 | 25.2 | | 24.4 | | | 21.9 | | | 19.3 | | | 16.8 | | | 14.8 | | | |
| 32 | 26.4 | 26.8 | | 24.2 | 23.9 | | 23.8 | 23.5 | | 21.5 | | | 18.9 | | | 16.5 | | | 14.5 | | | |
| 34 | 24.9 | 25.5 | | 22.8 | 22.8 | | 22.6 | 22.4 | | 21.1 | 20.7 | | 18.5 | | | 16.2 | | | 14.2 | | | |
| 36 | | 24.3 | 22.4 | 21.5 | 21.7 | | 21.5 | 21.3 | | 20.2 | 19.7 | | 18.2 | 17.6 | | 15.8 | 15.3 | | 13.8 | | | |
| 38 | | 23.1 | 21.1 | 20.6 | 19.4 | | 20.4 | 20.4 | | 19.5 | 18.8 | | 17.9 | 17.3 | | 15.5 | 15.0 | | 13.4 | 12.7 | | |
| 40 | | 21.9 | 19.9 | 19.7 | 18.3 | | 19.5 | 17.4 | | 18.0 | 18.0 | | 16.8 | 16.8 | | 14.6 | 14.6 | | 12.1 | 11.5 | | |
| 42 | | | 18.8 | | 17.3 | | 18.6 | 16.5 | | 17.2 | 17.2 | | 16.1 | 16.1 | | 14.0 | 14.0 | | 11.5 | 11.0 | | |
| 44 | | | 17.8 | | 16.4 | | | 15.6 | | 16.4 | 14.2 | | 15.4 | 15.4 | | 13.4 | 13.4 | | 11.0 | 10.5 | | |
| 46 | | | | | 15.6 | | | 14.8 | | | 13.5 | | | | 12.3 | | | | 10.5 | 10.0 | | |
| 48 | | | | | | | | 14.1 | | | 12.8 | | | | 11.6 | | 6.4 | 6.4 | 10.0 | 9.5 | | |
| 50 | | | | | | | | | | | 12.1 | | | | 11.0 | | 6.4 | 6.4 | 9.5 | 9.0 | 4.8 | |
| 52 | | | | | | | | | | | | | | | 10.5 | | 6.3 | 6.3 | 9.0 | 8.5 | 4.9 | |
| 54 | | | | | | | | | | | | | | | | | 6.0 | 6.0 | 8.5 | 8.0 | 4.9 | |
| 56 | | | | | | | | | | | | | | | | | | | 8.0 | 7.5 | 4.8 | |

64401

 35.2m-65.6m
  3.5m
  E
 
 82°/75°/68° 36m
  8.9m x 8.53m
  360°
  140t
  Y-ガイ

| メインブーム長さ ジブ長さ 作業半径(m) | 35.2m+7m 36m | | | 40.3m+7m 36m | | | 45.3m+7m 36m | | | 50.4m+7m 36m | | | 55.5m+7m 36m | | | 60.5m+7m 36m | | | 65.6m+7m 36m | | | |
|-----------------------------|-----------------|------|------|-----------------|------|------|-----------------|------|-----|-----------------|------|-----|-----------------|------|------|-----------------|------|-----|-----------------|------|-----|--|
| | 82° | 75° | 68° | 82° | 75° | 68° | 82° | 75° | 68° | 82° | 75° | 68° | 82° | 75° | 68° | 82° | 75° | 68° | 82° | 75° | 68° | |
| 20 | 22.2 | | | | | | | | | | | | | | | | | | | | | |
| 22 | 23.1 | | | 22.5 | | | 17.1 | | | | | | | | | | | | | | | |
| 24 | 24.1 | | | 23.0 | | | 19.4 | | | 18.6 | | | | | | | | | | | | |
| 26 | 24.8 | | | 23.2 | | | 21.0 | | | 19.2 | | | 16.8 | | | 14.7 | | | | | | |
| 28 | 24.5 | | | 23.1 | | | 21.1 | | | 19.1 | | | 16.8 | | | 14.7 | | | 12.8 | | | |
| 30 | 24.1 | 23.6 | | 22.8 | | | 20.9 | | | 18.8 | | | 16.6 | | | 14.5 | | | 12.7 | | | |
| 32 | 23.2 | 23.6 | | 22.3 | 21.7 | | 20.6 | | | 18.6 | | | 16.3 | | | 14.2 | | | 12.5 | | | |
| 34 | 22.2 | 23.0 | | 21.2 | 20.7 | | 20.3 | 19.9 | | 18.3 | | | 16.1 | | | 13.9 | | | 12.2 | | | |
| 36 | 21.2 | 22.0 | | 20.2 | 19.7 | | 20.0 | 19.7 | | 18.0 | 17.5 | | 15.8 | | | 13.7 | | | 12.0 | | | |
| 38 | 20.3 | 21.0 | 20.5 | 19.2 | 18.9 | | 19.7 | 19.3 | | 17.7 | 17.3 | | 15.5 | 15.0 | | 13.4 | 12.9 | | 11.7 | | | |
| 40 | 19.4 | 20.1 | 19.7 | 18.2 | 18.0 | 17.2 | 18.9 | 18.5 | | 17.4 | 17.0 | | 15.2 | 14.8 | | 13.1 | 12.7 | | 11.4 | | | |
| 42 | | 19.3 | 18.7 | 17.2 | 16.6 | 18.0 | 17.7 | 17.7 | | 16.3 | 16.3 | | 15.0 | 14.6 | | 12.9 | 12.5 | | 11.2 | 10.5 | | |
| 44 | | 18.4 | 17.7 | 16.5 | 15.9 | | 17.0 | 15.2 | | 15.6 | 15.2 | | 14.7 | 14.3 | | 12.6 | 12.3 | | 10.9 | 10.1 | | |
| 46 | | 17.5 | 16.8 | 15.8 | 15.3 | | 16.3 | 14.4 | | 15.0 | 13.0 | | 13.9 | 13.9 | | 12.0 | 12.0 | | 9.7 | 9.7 | | |
| 48 | | | 16.0 | 14.6 | 14.6 | | 15.7 | 13.7 | | 14.4 | 12.3 | | 13.4 | 13.4 | | 11.3 | 11.3 | | 9.3 | 9.3 | | |
| 50 | | | 15.2 | 13.9 | 13.9 | | 13.0 | 13.0 | | 13.8 | 11.7 | | 12.8 | 12.8 | 10.5 | 10.4 | 3.7 | | 8.9 | 8.9 | | |
| 52 | | | | 13.2 | 13.2 | | | 12.4 | | | 11.1 | | | | 10.0 | 9.4 | 3.8 | | 8.5 | 8.5 | | |
| 54 | | | | | | | | 11.8 | | | 10.5 | | | | 9.5 | 8.6 | 3.9 | | 8.2 | 8.2 | 4.2 | |
| 56 | | | | | | | | | | | 10.0 | | | | 9.1 | 8.6 | 3.8 | | 8.5 | 8.5 | 4.3 | |
| 58 | | | | | | | | | | | | | | | 8.6 | 8.6 | 3.7 | | 8.2 | 8.2 | 4.2 | |
| 60 | | | | | | | | | | | | | | | | | 3.5 | | 8.0 | 8.0 | 4.1 | |
| 62 | | | | | | | | | | | | | | | | | | | 7.5 | 7.5 | 3.9 | |

64501

起伏式ジブ(ガイ、エクセンダー仕様) 定格総荷重表 TYVEN

LTM 1400NX



| メインブーム長さ ジブ長さ | 35.2m+7m 42m | | | 40.3m+7m 42m | | | 45.3m+7m 42m | | | 50.4m+7m 42m | | | 55.5m+7m 42m | | | 60.5m+7m 42m | | | 65.6m+7m 42m | | |
|------------------|-----------------|------|------|-----------------|------|------|-----------------|------|------|-----------------|-----|-----|-----------------|-----|-----|-----------------|-----|-----|-----------------|-----|-----|
| | 82° | 75° | 68° | 82° | 75° | 68° | 82° | 75° | 68° | 82° | 75° | 68° | 82° | 75° | 68° | 82° | 75° | 68° | 82° | 75° | 68° |
| 22 | 20.0 | | | 18.0 | | | | | | | | | | | | | | | | | |
| 24 | 20.4 | | | 18.5 | | | 16.2 | | | | | | | | | | | | | | |
| 26 | 20.5 | | | 18.9 | | | 17.0 | | | | | | | | | | | | | | |
| 28 | 20.3 | | | 19.0 | | | 17.3 | | | | | | | | | | | | | | |
| 30 | 19.8 | | | 19.0 | | | 17.3 | | | | | | | | | | | | | | |
| 32 | 19.2 | 19.2 | | 18.7 | | | 17.3 | | | | | | | | | | | | | | |
| 34 | 18.5 | 19.2 | | 18.4 | 18.3 | | 17.1 | | | | | | | | | | | | | | |
| 36 | 17.6 | 18.5 | | 17.9 | 18.0 | | 16.9 | 16.5 | | | | | | | | | | | | | |
| 38 | 16.7 | 17.7 | | 17.0 | 17.2 | | 16.6 | 16.4 | | | | | | | | | | | | | |
| 40 | 16.0 | 16.9 | | 16.3 | 16.4 | | 16.4 | 16.2 | | | | | | | | | | | | | |
| 42 | 15.2 | 16.1 | 15.5 | 15.5 | 15.7 | | 15.8 | 16.0 | | | | | | | | | | | | | |
| 44 | 14.5 | 15.4 | 14.9 | 14.8 | 15.0 | 14.0 | 15.1 | 15.4 | | | | | | | | | | | | | |
| 46 | 13.9 | 14.8 | 14.3 | 14.2 | 14.3 | 13.5 | 14.4 | 14.8 | 13.9 | | | | | | | | | | | | |
| 48 | | 14.1 | 13.8 | | 13.7 | 13.0 | 13.9 | 14.1 | 13.4 | 14.0 | | | | | | | | | | | |
| 50 | | 13.4 | 13.2 | | 13.1 | 12.5 | | 13.6 | 12.8 | | | | | | | | | | | | |
| 52 | | 12.6 | 12.7 | | 12.5 | 12.0 | | 13.1 | 12.2 | | | | | | | | | | | | |
| 54 | | | 12.2 | | | 11.6 | | 12.6 | 11.6 | | | | | | | | | | | | |
| 56 | | | 11.7 | | | 11.1 | | 11.1 | 11.1 | | | | | | | | | | | | |
| 58 | | | | | | 10.7 | | | 10.6 | | | | | | | | | | | | |
| 60 | | | | | | | | | 10.1 | | | | | | | | | | | | |
| 62 | | | | | | | | | | | | | | | | | | | | | |
| 64 | | | | | | | | | | | | | | | | | | | | | |
| 66 | | | | | | | | | | | | | | | | | | | | | |
| 68 | | | | | | | | | | | | | | | | | | | | | |

64601



| メインブーム長さ ジブ長さ | 35.2m+7m 48m | | | 40.3m+7m 48m | | | 45.3m+7m 48m | | | 50.4m+7m 48m | | | 55.5m+7m 48m | | | 60.5m+7m 48m | | | 65.6m+7m 48m | | |
|------------------|-----------------|------|------|-----------------|------|------|-----------------|------|------|-----------------|------|------|-----------------|-----|-----|-----------------|-----|-----|-----------------|-----|-----|
| | 82° | 75° | 68° | 82° | 75° | 68° | 82° | 75° | 68° | 82° | 75° | 68° | 82° | 75° | 68° | 82° | 75° | 68° | 82° | 75° | 68° |
| 24 | 16.1 | | | 14.3 | | | | | | | | | | | | | | | | | |
| 26 | 16.5 | | | 14.8 | | | 13.7 | | | | | | | | | | | | | | |
| 28 | 16.6 | | | 15.3 | | | 14.1 | | | | | | | | | | | | | | |
| 30 | 16.6 | | | 15.5 | | | 14.3 | | | | | | | | | | | | | | |
| 32 | 16.4 | | | 15.6 | | | 14.3 | | | | | | | | | | | | | | |
| 34 | 16.2 | 15.6 | | 15.7 | | | 14.3 | | | | | | | | | | | | | | |
| 36 | 16.0 | 15.6 | | 15.6 | 15.0 | | 14.2 | | | | | | | | | | | | | | |
| 38 | 15.9 | 15.5 | | 15.5 | 15.0 | | 14.2 | 13.9 | | | | | | | | | | | | | |
| 40 | 15.7 | 15.5 | | 15.4 | 15.0 | | 14.1 | 13.8 | | | | | | | | | | | | | |
| 42 | 15.6 | 15.4 | | 15.3 | 14.9 | | 13.9 | 13.7 | | | | | | | | | | | | | |
| 44 | 15.1 | 14.7 | 13.9 | 15.0 | 14.3 | | 13.7 | 13.5 | | | | | | | | | | | | | |
| 46 | 14.4 | 14.1 | 13.4 | 14.3 | 13.7 | | 13.6 | 13.4 | | | | | | | | | | | | | |
| 48 | 13.7 | 13.5 | 12.9 | 13.7 | 13.1 | 12.1 | 13.4 | 13.0 | | | | | | | | | | | | | |
| 50 | 13.0 | 13.0 | 12.5 | 13.0 | 12.5 | 11.7 | 13.1 | 12.4 | 11.5 | 11.9 | 11.7 | | | | | | | | | | |
| 52 | 12.3 | 12.4 | 12.0 | 12.4 | 12.0 | 11.2 | 12.5 | 11.9 | 11.1 | 11.8 | 11.5 | 10.5 | | | | | | | | | |
| 54 | | 11.9 | 11.5 | | 11.5 | 10.8 | 11.8 | 11.5 | 10.7 | 11.6 | 11.1 | 10.0 | 10.1 | 9.8 | | | | | | | |
| 56 | | 11.3 | 11.1 | | 11.0 | 10.4 | | 11.0 | 10.3 | | | | | | | | | | | | |
| 58 | | 10.6 | | | 10.5 | 10.0 | | 10.5 | 9.9 | | | | | | | | | | | | |
| 60 | | | 10.3 | | | 9.7 | | 10.1 | 9.5 | | | | | | | | | | | | |
| 62 | | | 9.9 | | | 9.3 | | | 9.2 | | | | | | | | | | | | |
| 64 | | | | | | 8.9 | | | 8.8 | | | | | | | | | | | | |
| 66 | | | | | | | | | 8.5 | | | | | | | | | | | | |
| 68 | | | | | | | | | | | | | | | | | | | | | |
| 70 | | | | | | | | | | | | | | | | | | | | | |
| 72 | | | | | | | | | | | | | | | | | | | | | |
| 74 | | | | | | | | | | | | | | | | | | | | | |

64701

起伏式ジブ(ガイ、エクセンダー仕様) 定格総荷重表 TYVEN

LTM 1400NX

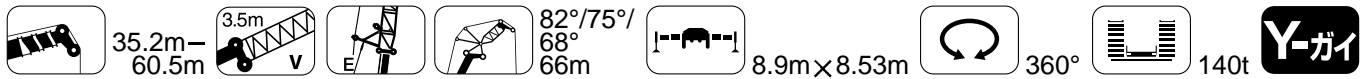

| メインブーム長さ ジブ長さ 角度 | 35.2m+7m 66m | | | 40.3m+7m 66m | | | 45.3m+7m 66m | | | 50.4m+7m 66m | | | 55.5m+7m 66m | | | 60.5m+7m 66m | |
|------------------------|-----------------|-----|-----|-----------------|-----|-----|-----------------|-----|-----|-----------------|-----|-----|-----------------|-----|-----|-----------------|-----|
| | 82° | 75° | 68° | 82° | 75° | 68° | 82° | 75° | 68° | 82° | 75° | 68° | 82° | 75° | 68° | 82° | 75° |
| 28 | 8.3 | | | | | | | | | | | | | | | | |
| 30 | 8.3 | | | 7.2 | | | 6.8 | | | | | | | | | | |
| 32 | 8.4 | | | 7.4 | | | 6.9 | | | | | | | | | | |
| 34 | 8.5 | | | 7.5 | | | 7.0 | | | | | | 3.9 | | | 3.0 | |
| 36 | 8.5 | | | 7.7 | | | 7.1 | | | | | | 4.4 | | | 4.0 | |
| 38 | 8.5 | | | 7.7 | | | 7.2 | | | | | | 5.0 | | | 4.1 | |
| 40 | 8.5 | | | 7.8 | | | 7.2 | | | | | | 5.1 | | | 4.2 | |
| 42 | 8.5 | 8.0 | | 7.9 | | | 7.1 | | | | | | 5.2 | | | 4.4 | |
| 44 | 8.4 | 8.1 | | 7.9 | 7.7 | | 7.1 | 7.2 | | | | | 5.3 | | | 4.4 | |
| 46 | 8.3 | 8.1 | | 7.8 | 7.8 | | 7.1 | 7.2 | | | | | 5.3 | | | 4.4 | |
| 48 | 8.2 | 8.1 | | 7.8 | 7.8 | | 7.0 | 7.2 | | | 6.3 | | 5.3 | | | 4.4 | |
| 50 | 8.2 | 8.0 | | 7.8 | 7.8 | | 7.0 | 7.1 | | | 6.2 | 6.2 | 5.3 | 5.2 | | 4.4 | |
| 52 | 8.1 | 8.0 | | 7.8 | 7.8 | | 7.0 | 7.1 | | | 6.2 | 6.2 | 5.2 | 5.1 | | 4.3 | 3.7 |
| 54 | 8.0 | 7.9 | 7.3 | 7.8 | 7.7 | | 6.9 | 7.0 | | | 6.1 | 6.1 | 5.2 | 5.1 | | 4.3 | 3.8 |
| 56 | 8.0 | 7.8 | 7.4 | 7.7 | 7.7 | 6.9 | 6.9 | 6.9 | | | 6.1 | 6.0 | 5.2 | 5.0 | | 4.3 | 3.8 |
| 58 | 7.9 | 7.8 | 7.4 | 7.6 | 7.7 | 7.0 | 6.8 | 6.9 | 6.4 | | 6.0 | 6.0 | 5.1 | 5.0 | | 4.2 | 3.8 |
| 60 | 7.9 | 7.8 | 7.2 | 7.5 | 7.6 | 6.7 | 6.6 | 6.8 | 6.4 | 6.0 | 5.9 | | 5.1 | 4.9 | | 4.2 | 3.8 |
| 62 | 7.8 | 7.5 | 6.9 | 7.4 | 7.4 | 6.5 | 6.5 | 6.7 | 6.1 | 5.9 | 5.8 | 4.8 | 5.0 | 4.8 | | 4.1 | 3.7 |
| 64 | 7.6 | 7.2 | 6.7 | 7.3 | 7.1 | 6.3 | 6.4 | 6.7 | 5.9 | 5.9 | 5.8 | 4.9 | 5.0 | 4.8 | | 4.0 | 3.6 |
| 66 | 7.2 | 6.9 | 6.4 | 7.2 | 6.8 | 6.0 | 6.2 | 6.5 | 5.7 | 5.7 | 5.7 | 4.9 | 4.9 | 4.7 | 1.2 | 4.0 | 3.6 |
| 68 | 6.8 | 6.6 | 6.2 | 7.0 | 6.5 | 5.8 | 6.0 | 6.2 | 5.4 | 5.6 | 5.7 | 4.9 | 4.8 | 4.6 | 1.4 | 3.9 | 3.4 |
| 70 | | 6.4 | 6.3 | 6.6 | 6.2 | 5.6 | 5.8 | 5.9 | 5.2 | 5.3 | 5.6 | 4.8 | 4.6 | 4.6 | 1.5 | 3.9 | 3.2 |
| 72 | | | 6.0 | 5.7 | 5.9 | 5.3 | 5.6 | 5.7 | 5.0 | 5.1 | 5.4 | 4.6 | 4.4 | 4.5 | 1.5 | 3.6 | 3.0 |
| 74 | | | 5.7 | 5.5 | 5.7 | 5.1 | 5.4 | 4.8 | 4.6 | | 5.2 | 4.4 | 4.5 | 1.6 | 3.4 | 2.7 | |
| 76 | | | 5.2 | 5.2 | 5.4 | 4.9 | 4.9 | 4.6 | 4.6 | | 4.9 | 4.2 | 4.4 | 1.6 | | 2.5 | |
| 78 | | | | 5.0 | | 4.7 | | 4.9 | 4.4 | | 4.7 | 4.0 | 4.4 | 1.6 | | 2.1 | |
| 80 | | | | | | 4.5 | | | 4.2 | | 4.4 | 3.8 | 4.1 | 1.5 | | 1.8 | |
| 82 | | | | | | 4.3 | | | 4.0 | | | 3.6 | | 1.3 | | 1.3 | |
| 84 | | | | | | | | | 3.7 | | | 3.2 | | | | | |
| 86 | | | | | | | | | | | | 2.6 | | | | | |

65001

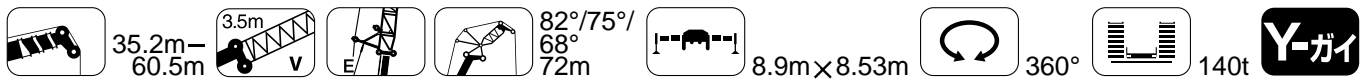

| メインブーム長さ ジブ長さ 角度 | 35.2m+7m 72m | | | 40.3m+7m 72m | | | 45.3m+7m 72m | | | 50.4m+7m 72m | | | 55.5m+7m 72m | | 60.5m+7m 72m | |
|------------------------|-----------------|-----|-----|-----------------|-----|-----|-----------------|-----|-----|-----------------|-----|-----|-----------------|-----|-----------------|-----|
| | 82° | 75° | 68° | 82° | 75° | 68° | 82° | 75° | 68° | 82° | 75° | 68° | 82° | 75° | 82° | 75° |
| 30 | 6.5 | | | | | | | | | | | | | | | |
| 32 | 6.5 | | | 5.6 | | | 5.1 | | | | | | | | | |
| 34 | 6.6 | | | 5.7 | | | 5.3 | | | | | | 2.9 | | | |
| 36 | 6.6 | | | 5.8 | | | 5.4 | | | | | | 3.2 | | | 1.6 |
| 38 | 6.6 | | | 5.9 | | | 5.5 | | | | | | 3.5 | | | 2.2 |
| 40 | 6.7 | | | 6.0 | | | 5.5 | | | | | | 3.8 | | | 2.6 |
| 42 | 6.6 | | | 6.0 | | | 5.6 | | | | | | 3.8 | | | 3.0 |
| 44 | 6.6 | | | 6.1 | | | 5.6 | | | | | | 3.9 | | | 3.1 |
| 46 | 6.5 | 6.0 | | 6.1 | 5.8 | | 5.6 | | | | | | 4.0 | | | 3.2 |
| 48 | 6.5 | 6.2 | | 6.1 | 5.9 | | 5.5 | 5.5 | | | | | 4.0 | | | 3.2 |
| 50 | 6.4 | 6.2 | | 6.1 | 6.0 | | 5.5 | 5.6 | | | | | 4.0 | | | 3.3 |
| 52 | 6.4 | 6.2 | | 6.1 | 6.0 | | 5.5 | 5.6 | | | | | 4.0 | 4.0 | | 3.3 |
| 54 | 6.3 | 6.2 | | 6.1 | 6.0 | | 5.4 | 5.6 | | | | | 3.9 | 4.0 | | 3.2 |
| 56 | 6.3 | 6.2 | 5.3 | 6.0 | 6.0 | | 5.4 | 5.5 | | | | | 3.9 | 3.9 | | 3.2 |
| 58 | 6.2 | 6.1 | 5.4 | 6.0 | 6.0 | | 5.3 | 5.5 | | | | | 3.9 | 3.9 | | 2.9 |
| 60 | 6.1 | 6.1 | 5.5 | 5.9 | 6.0 | 5.1 | 5.3 | 5.4 | | | | | 3.9 | 3.8 | | 2.9 |
| 62 | 6.1 | 6.1 | 5.6 | 5.8 | 5.9 | 5.2 | 5.2 | 5.4 | 4.8 | | | | 3.8 | 3.7 | | 2.9 |
| 64 | 6.0 | 6.0 | 5.7 | 5.7 | 5.9 | 5.3 | 5.1 | 5.3 | 4.9 | 4.6 | | | 3.8 | 3.7 | | 2.9 |
| 66 | 6.0 | 6.0 | 5.7 | 5.7 | 5.9 | 5.4 | 5.0 | 5.3 | 4.9 | 4.5 | | | 3.7 | 3.8 | | 3.0 |
| 68 | 5.9 | 6.0 | 5.6 | 5.6 | 5.8 | 5.2 | 4.8 | 5.2 | 4.9 | 4.4 | | | 3.8 | 3.7 | | 3.0 |
| 70 | 5.8 | 5.9 | 5.4 | 5.5 | 5.8 | 5.0 | 4.7 | 5.2 | 4.6 | 4.3 | | | 3.8 | 3.7 | | 2.9 |
| 72 | 5.7 | 5.6 | 5.2 | 5.4 | 5.5 | 4.8 | 4.6 | 5.2 | 4.5 | 4.2 | | | 3.8 | 3.5 | | 2.9 |
| 74 | 5.6 | 5.4 | 5.0 | 5.3 | 5.3 | 4.6 | 4.4 | 5.0 | 4.3 | 4.0 | | | 3.7 | 3.4 | | 2.5 |
| 76 | 5.3 | 5.1 | 4.8 | 5.2 | 5.0 | 4.4 | 4.3 | 4.8 | 4.1 | 3.9 | | | 3.6 | 3.2 | | 2.4 |
| 78 | | 4.9 | 4.6 | | 4.8 | 4.2 | 4.1 | 4.6 | 3.9 | 3.7 | | | 4.1 | 3.5 | | 2.1 |
| 80 | | 4.6 | 4.4 | | 4.6 | 4.1 | | 4.3 | 3.7 | 3.7 | | | 4.1 | 3.3 | | 1.9 |
| 82 | | 4.2 | 4.2 | | 4.3 | 3.9 | | 4.1 | 3.6 | | | | 3.9 | 3.2 | | 1.6 |
| 84 | | | 4.0 | | | 3.7 | | 3.8 | 3.4 | | | | 3.7 | 3.1 | | 1.4 |
| 86 | | | | | | 3.5 | | | 3.3 | | | | 3.4 | 2.9 | | |
| 88 | | | | | | 3.3 | | | 3.1 | | | | | 2.8 | | |
| 90 | | | | | | | | | 2.9 | | | | | 2.5 | | |
| 92 | | | | | | | | | | | | | | 2.0 | | |

65101

起伏式ジブ (ガイ、エクセンダー仕様) 定格総荷重表 TYVEN

LTM 1400NX

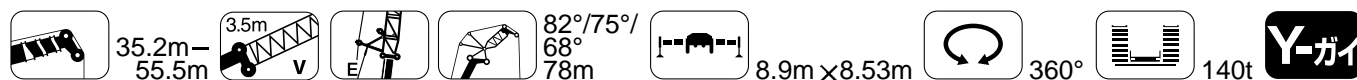

| メインブーム長さ ジブ長さ 角度 作業半径(m) | 35.2m+7m 78m | | | 40.3m+7m 78m | | | 45.3m+7m 78m | | | 50.4m+7m 78m | | | 55.5m+7m 78m | |
|-----------------------------------|-----------------|-----|-----|-----------------|-----|-----|-----------------|-----|-----|-----------------|-----|-----|-----------------|-----|
| | 82° | 75° | 68° | 82° | 75° | 68° | 82° | 75° | 68° | 82° | 75° | 68° | 82° | 75° |
| 32 | 4.8 | | | | | | | | | | | | | |
| 34 | 4.9 | | | | | | | | | | | | | |
| 36 | 4.9 | | | 4.5 | | | 3.6 | | | | | | | |
| 38 | 5.0 | | | 4.6 | | | 3.8 | | | | | | | |
| 40 | 4.9 | | | 4.6 | | | 3.9 | | | 2.8 | | | | |
| 42 | 4.9 | | | 4.6 | | | 4.0 | | | 3.0 | | | 1.3 | |
| 44 | 4.8 | | | 4.6 | | | 4.1 | | | 3.2 | | | 1.6 | |
| 46 | 4.8 | 4.5 | | 4.6 | | | 4.1 | | | 3.3 | | | 1.8 | |
| 48 | 4.8 | 4.6 | | 4.6 | 4.3 | | 4.1 | | | 3.4 | | | 2.1 | |
| 50 | 4.7 | 4.6 | | 4.5 | 4.4 | | 4.1 | 4.0 | | 3.4 | | | 2.4 | |
| 52 | 4.7 | 4.7 | | 4.5 | 4.5 | | 4.0 | 4.1 | | 3.5 | | | 2.6 | |
| 54 | 4.7 | 4.7 | | 4.4 | 4.5 | | 4.0 | 4.2 | | 3.5 | 3.6 | | 2.7 | 2.9 |
| 56 | 4.6 | 4.8 | | 4.4 | 4.6 | | 3.9 | 4.2 | | 3.5 | 3.6 | | 2.7 | 2.8 |
| 58 | 4.6 | 4.8 | | 4.4 | 4.6 | | 3.9 | 4.2 | | 3.5 | 3.5 | | 2.7 | 2.8 |
| 60 | 4.5 | 4.8 | 3.9 | 4.3 | 4.6 | | 3.8 | 4.1 | | 3.4 | 3.5 | | 2.7 | 2.7 |
| 62 | 4.5 | 4.7 | 4.0 | 4.2 | 4.6 | | 3.7 | 4.1 | | 3.4 | 3.4 | | 2.7 | 2.7 |
| 64 | 4.4 | 4.7 | 4.1 | 4.2 | 4.6 | | 3.7 | 4.0 | 3.4 | 3.3 | 3.4 | | 2.7 | 2.6 |
| 66 | 4.4 | 4.6 | 4.2 | 4.1 | 4.5 | | 3.6 | 4.0 | 3.5 | 3.2 | 3.3 | | 2.7 | 2.6 |
| 68 | 4.3 | 4.6 | 4.2 | 4.0 | 4.5 | | 3.5 | 4.0 | 3.6 | 3.2 | 3.3 | 2.5 | 2.6 | 2.6 |
| 70 | 4.3 | 4.5 | 4.3 | 4.0 | 4.4 | | 3.4 | 3.9 | 3.6 | 3.1 | 3.3 | 2.6 | 2.5 | 2.5 |
| 72 | 4.2 | 4.5 | 4.3 | 3.9 | 4.3 | | 3.3 | 3.9 | 3.6 | 3.0 | 3.2 | 2.7 | 2.4 | 2.5 |
| 74 | 4.1 | 4.5 | 4.3 | 3.8 | 4.1 | 3.4 | 3.2 | 3.9 | 3.6 | 2.9 | 3.2 | 2.8 | 2.3 | 2.5 |
| 76 | 4.1 | 4.4 | 4.2 | 3.8 | 3.9 | 3.3 | 3.1 | 3.8 | 3.5 | 2.7 | 3.2 | 2.8 | 2.2 | 2.4 |
| 78 | 4.0 | 4.4 | 4.0 | 3.7 | 3.7 | 3.1 | 3.0 | 3.8 | 3.4 | 2.6 | 3.1 | 2.8 | 2.1 | 2.4 |
| 80 | 4.0 | 4.2 | 3.8 | 3.6 | 3.5 | 3.0 | 2.8 | 3.8 | 3.2 | 2.5 | 3.1 | 2.7 | 2.0 | 2.3 |
| 82 | 3.9 | 4.0 | 3.7 | 3.5 | 3.4 | 2.9 | 2.7 | 3.7 | 3.1 | 2.3 | 3.1 | 2.7 | 1.8 | 2.3 |
| 84 | | 3.8 | 3.5 | | 3.1 | 2.1 | | 3.5 | 2.9 | 2.2 | 3.0 | 2.6 | 1.6 | 2.3 |
| 86 | | 3.5 | 3.3 | | 2.9 | 1.4 | | 3.3 | 2.8 | | 3.0 | 2.5 | | 2.3 |
| 88 | | 3.2 | 3.2 | | 2.7 | | | 3.2 | 2.7 | | 3.0 | 2.3 | | 2.2 |
| 90 | | | 3.0 | | | | | 2.9 | 2.6 | | 2.8 | 2.2 | | 2.2 |
| 92 | | | 2.9 | | | | | | 2.4 | | 2.6 | 2.1 | | 2.2 |
| 94 | | | | | | | | | 2.3 | | | 2.0 | | |
| 96 | | | | | | | | | 2.1 | | | 1.7 | | |

65201

主部材寸法

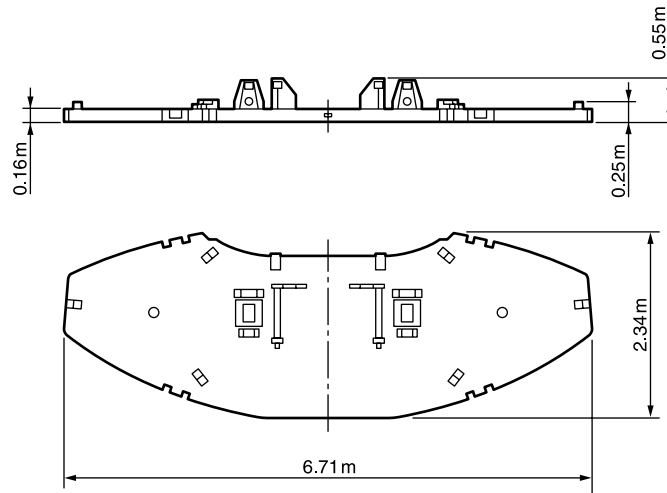

カウンタウエイト 15.0t

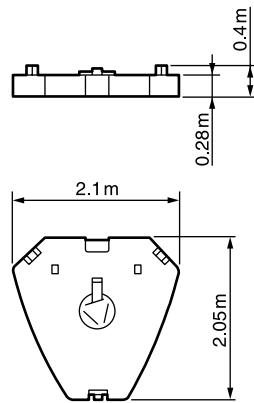

カウンタウエイト 5.0t

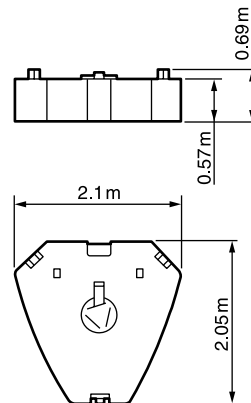

カウンタウエイト 10.0t

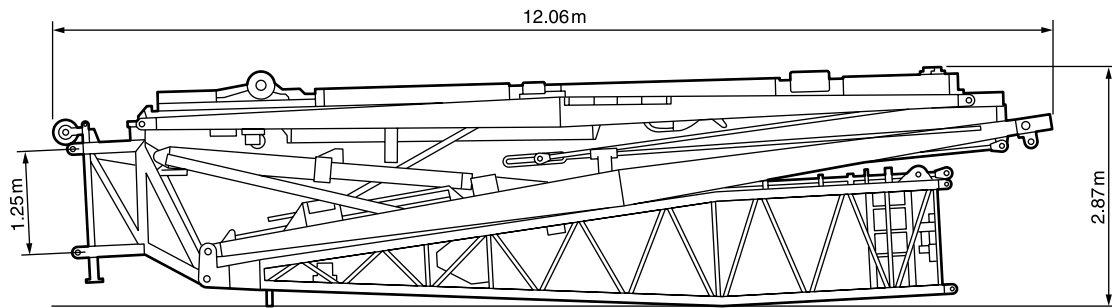

起伏ジブ基部 8.0t 幅 2.01m

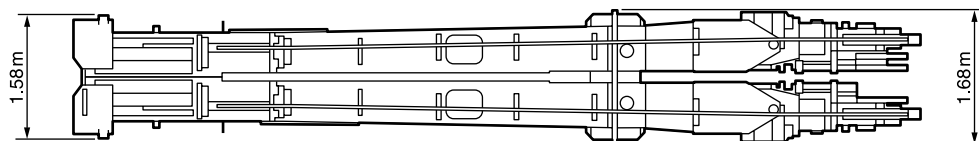
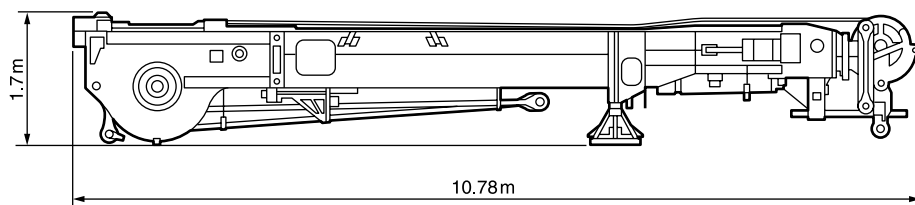

TY-ガイ (輸送用装置付) 14.0t

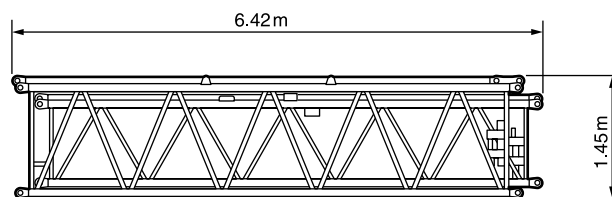

中間ジブ 6m 1.5t 幅 1.73m

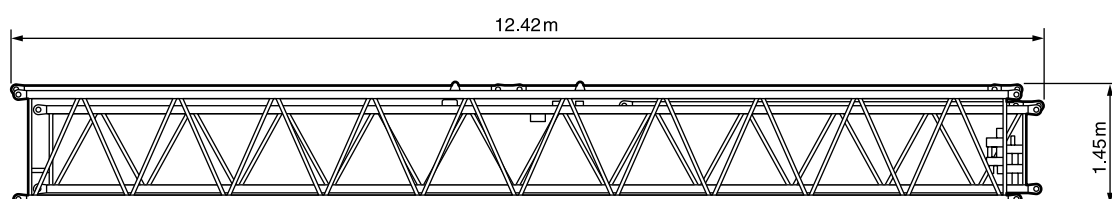

中間ジブ 12m 2.7t 幅 1.73m

主寸法

LTM 1400NX

外観寸法

単位：mm

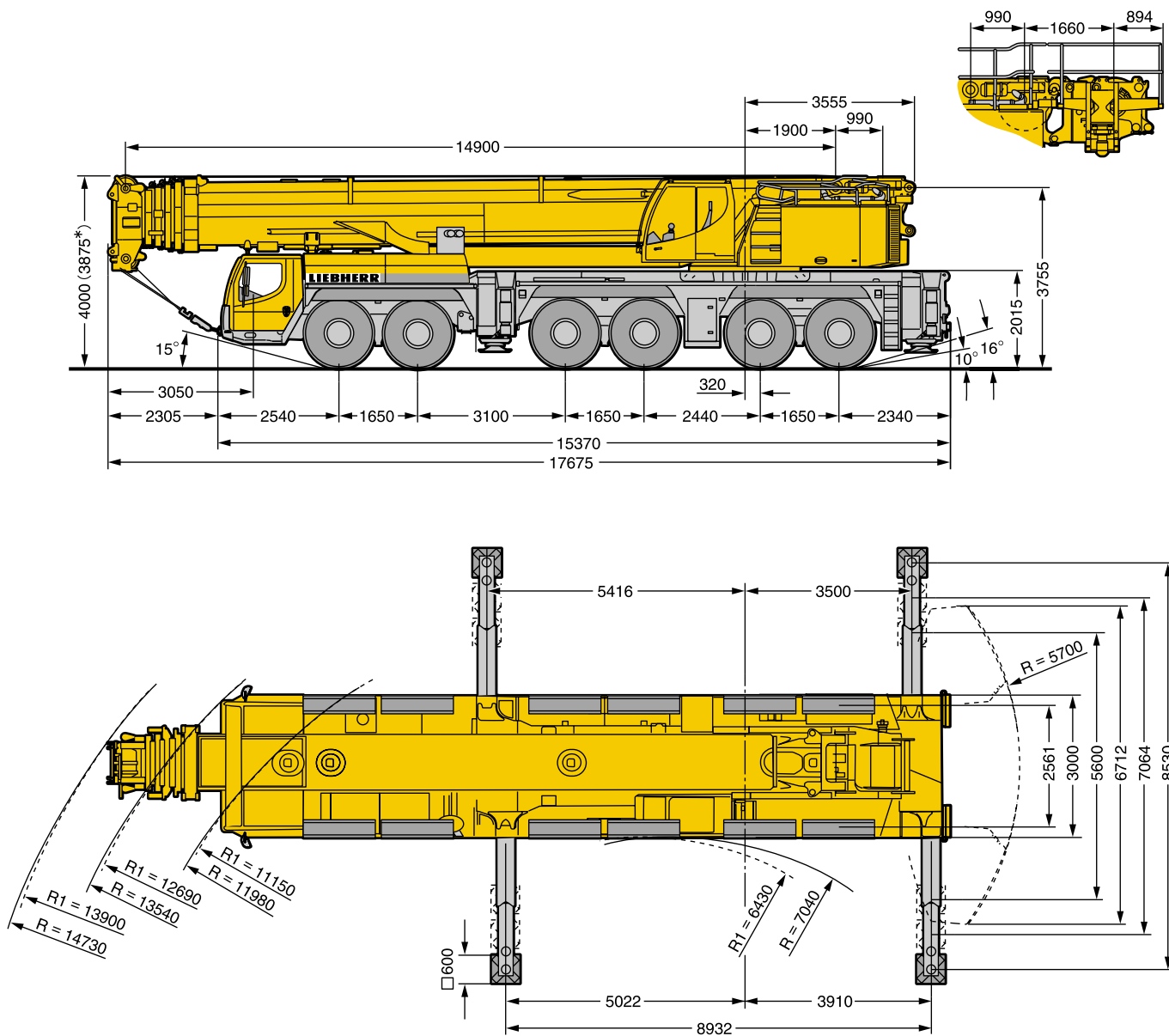

*サスペンションを125mm下げた状態
R1 = 全輪ステアリング時

リープヘル・ジャパン株式会社

〒230-0053 横浜市鶴見区大黒町5番39号

TEL 045-505-8687 (営業)

045-505-8689 (サービス)

FAX 045-505-8683

なお、本仕様は予告なく変更することがあります。

TD 180.00.DEFISR01.2009

2010.2.2000

Courtesy of Crane.Market