

# Pipelayers

**RL 44**  
Litronic®

**RL 54**  
Litronic®

**RL 64**  
Litronic®

Engine output:	175 kW / 238 HP	210 kW / 286 HP	275 kW / 374 HP
Max. lift capacity:	45.900 kg 101,192 lb	70.000 kg 154,323 lb	90.800 kg 200,179 lb

**LIEBHERR**

*Courtesy of Machine.Market*

# **RL 44**

Litronic®

---

Engine output: 175 kW / 238 HP  
Operating weight: 35.100 kg / 77,382 lb  
Max. lift capacity: 45.900 kg / 101,192 lb

# **RL 54**

Litronic®

---

Engine output: 210 kW / 286 HP  
Operating weight: 45.900 kg / 101,192 lb  
Max. lift capacity: 70.000 kg / 154,323 lb

# **RL 64**

Litronic®

---

Engine output: 275 kW / 374 HP  
Operating weight: 58.800 kg / 129,632 lb  
Max. lift capacity: 90.800 kg / 200,179 lb

## **Performance**

High Performance and Innovative Technology: These are the trademarks of the generation 4 of Liebherr pipelayers. The high lifting capacity, the powerful Liebherr construction machinery engine in conjunction with an innovative hydrostatic travel drive as well as precision hydraulics ensure maximum productivity even under the most difficult operating conditions. Whether laying pipe on a slope or in extremely soft soil – Liebherr pipelayers will impress you with their outstanding performance capabilities.

## **Reliability**

Liebherr pipelayers have been developed to meet requirements at construction sites around the world and designed throughout for a long service life. Whether at low temperatures in Siberia or in hot desert regions, the rugged and time-tested construction of Liebherr pipelayers provides maximum reliability and availability.

## **Comfort**

Liebherr's generation 4 of pipelayers offers the operator a generously dimensioned working environment designed on the basis of the latest ergonomic principles. The spacious comfort cab assures optimum visibility of the working area and surroundings. Thanks to its intuitive single-lever control, the machine can be manoeuvred with precision and literally by fingertip.

## **Economy**

Clear economic benefits – the Liebherr advantage: Like all other Liebherr equipment, these pipelayers are characterised by their service friendliness. This reduces both downtime and maintenance costs. The Liebherr diesel engines combine high performance and economy – the combination of an efficient drive system and load-sensing hydraulics guarantees minimum fuel consumption.

## **Safety**

Safety is always a priority at Liebherr! Accordingly, all pipelayers have a well-thought-out safety concept. Important details such as the ROPS cab, the boom-positioning cylinder, the automatic parking brake, optional load moment limiting and the extremely precise hydraulics make Liebherr pipelayers among the safest.



**The Liebherr diesel engine features the latest technology**

- Using electronically modelled output and torque curves, the engine provides sufficient power for travel and working hydraulics.

**Hydrostatic travel drive**

- Each side of the drive has a separate and closed hydraulic circuit. This allows each side of the undercarriage to be controlled independently and steplessly.



**Excellent manoeuvrability**

- All steering commands from the operator are transmitted precisely to both sides of the undercarriage. Turning on the spot is thus possible even with maximum load.
- This function can be used to easily slew heavy pipes to the side.

# Performance

Liebherr pipelayers are designed to provide maximum performance and handle the most difficult jobs. High lifting forces, outstanding manoeuvrability and heavy-duty components in the travel and working hydraulics ensure peak performance when laying pipelines.

## Powerful and stepless travel drive

In combination with the innovative hydrostatic travel drive, the powerful Liebherr diesel engine provides maximum power in every situation. Whether transporting pipe on soft soil, lowering the pipeline when travelling uphill, or when pulling heavy pipe-bending machines - the hydrostatic travel drive reliably provides the required power.

### Stepless and precise control of the travel speed

The travel drive makes it possible to travel without jerky movements and extremely precisely without shifting gears. This reduces vibrations when transporting pipe and provides essentially millimetre-accurate joining during pre-assembly.

### Power for travelling on slopes

The hydrostatic travel drive allows the operator to manoeuvre the machine easily and with maximum precision even on steep slopes. The safety brake (parking brake) opens and closes automatically – it is impossible for the machine to roll away on the slope!

## High stability

The compact arrangement of the travel drive components results in an extremely low centre of gravity for the machine. Through use of the extra-long undercarriage, Liebherr pipelayers offer maximum stability, especially on inclines.

## High lifting capacities

Thanks to the favourable weight distribution / centre of gravity, the extended position of the counterweight and the extra long undercarriage, maximum lifting capacities are available over the entire working range.

### Extra-long undercarriage

- The long undercarriage used in Liebherr pipelayers increases the stability of the machine, especially when working in soft soil or on slopes.

### Long boom

- Long booms are optionally available for all Liebherr pipelayers. These permit an even greater working range.



**Powerful winch drive  
with maximum visibility  
of the drum**

- Stepless speed control
- Precise load positioning
- Quick drop function
- Automatically activated holding brake with a wear-free, wet multi-disc brake design



**Powerful working  
cylinders**

- Millimetre-accurate control of the boom
- No dangerous shaking of the boom when travelling
- Maintenance-free design

# Reliability

## Intelligent hydraulics

### Sensitive and precise

Very precise control of the boom and winch. Pipe is placed with millimetre accuracy – this is a major benefit when connecting pipes during pre-assembly as well as when repairing the pipeline.

### Powerful winch drive

The hydraulically powered winch permits stepless and precise speed control of the load hook. The load is lowered reliably without any loss of force. As soon as the winch stops moving, the automatic safety brake is activated and holds the load securely.

### Powerful working cylinders

The Liebherr boom-positioning cylinder stabilises heavy loads in every position.

### Load-Independent Flow Distribution (LIFD)

All joystick motions are converted precisely into the corresponding machine motion by the Liebherr hydraulic controls regardless of the load being moved.

## Rear equipment

### Towing attachment

Liebherr pipelayers come with a rugged, towing attachment bolted to the rear as a standard feature.

### Drawbar

To pull heavy equipment (e.g. large bending machines), a drawbar is optionally available.

### Rear winch

A hydrostatically operated winch can be attached to the rear of the main frame on all Liebherr pipelayers. This increases the versatility of the equipment on the construction site.

### High ground clearance

- Liebherr pipelayers offer extremely high ground clearance. This makes it possible to work even under harsh weather conditions.

### Low ground pressure

- Thanks to the very wide track shoes and extra long undercarriage, Liebherr pipelayers apply very low ground pressure.
- It is thus possible to work closer to the pipeline trench, permitting in turn use of the higher lifting capacity.

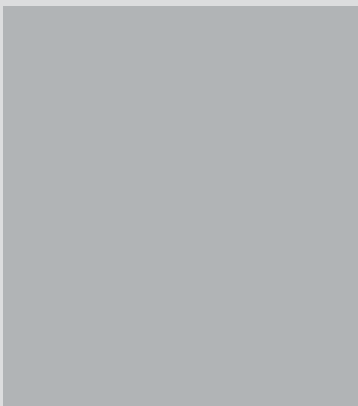

**Maintenance-friendly design**

- Wide-opening engine compartment doors provide easy access to the centralised maintenance points.

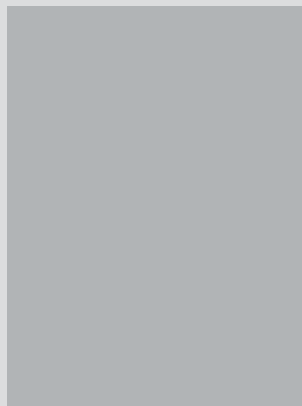

**Protected components**

- Maintenance-free batteries
- Sealed containers protect batteries and on-board electronics.



# Economy

Liebherr pipelayers are known for providing maximum economy. Accordingly, when the machines were being designed, special attention was devoted to ensuring long component service lives, low service costs and low fuel consumption.

## Low service costs

**Maximum accessibility to all maintenance points** All service points on the diesel engine are centralised, readily accessible on one side of the machine. Separate containers for the batteries, the electronics and the on-board tools offer the best protection, while providing easy and quick access.

**Unmatched oil change intervals** Liebherr oils and lubricants are specially formulated for the harsh operating conditions of pipelayers. Thanks to the special properties of these oils, achievable oil change intervals can be as much as four times longer than those for conventional oils. This lowers the amount of service required, reduces the amount of oil used and protects the environment.

## Low fuel consumption

The Liebherr diesel engine runs at a constant low speed – in an economical range – regardless of the travel speed. The result is exceptionally low fuel consumption.

**Economical hydraulics** The load-sensing on-demand controls supply only the exact amount of oil needed. This protects the components and saves fuel.

**Innovative cooling system** The hydrostatically powered fan regulates the cooling capacity to meet requirements, regardless of the diesel engine rpm. This ensures optimal cooling capacity and saves fuel.

### Tilting operator cab

- The standard tilting operator cab provides fast and easy access to all important components of the travel drive and hydraulics.

### Components and spare parts logistics

- The main components of Liebherr pipelayers are identical to those used in the crawler tractors, greatly simplifying maintenance and repair as well as spare parts supply.

### Long intervals between oil changes

- When Liebherr hydraulic fluids are used, oil changes are not needed until after 6,000 operating hours or a maximum of 4 years with regular oil analyses - when biodegradable Liebherr Plus hydraulic fluids are used, up to after 8,000 operating hours or up to 4 years.



#### **Boom can be lowered to ground level**

- For easy disassembly and reassembly, the boom on the RL 54 and RL 64 can be lowered to ground level by means of cylinders.
- The detent pin between the lifting cylinder and boom can be shifted horizontally by means of a positioning mechanism for disassembly and re-assembly.
- Once the boom cylinder has been uncoupled, it is brought into the transport position.

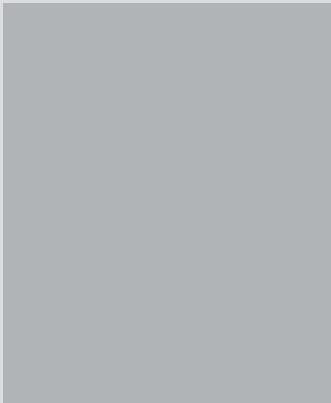

#### **Optimised transport dimensions**

- Liebherr pipelayers are designed to internationally accepted transport widths.
- Use of detachable brackets make small and thus economical transport dimensions possible.

# Economy

## Short conversion times

**Easy assembly and disassembly of the boom as well as the counterweights**

The boom can be dismantled quickly and lifting cylinder folded into the transport position. The hook block can be stowed in the left storage compartment above the undercarriage. The individual counterweight plates can be disassembled and loaded, so that the Liebherr pipelayer can be transported by lorry to the next construction site.

## Maximum functionality

**High-performance hydraulic connection for generator operation (option)**

All Liebherr pipelayers can be fitted with powerful hydraulic connections to operate generators to provide electric power and electricity for welding.

**Hydraulic connection for pipe facing (option)**

An additional hydraulic circuit provided at the engine bonnet permits connection of pipe facing equipment.

**Liebherr pipelayers as multifunctional units (option)**

Pipelayers can also be fitted with a telescopic crane for transporting welding tents, as well as with power generators or compressors for pipe welding.

**Winch (option)**

A winch with three-roller fairlead and stepless control can be attached to the rear of Liebherr pipelayers.

## LiDAT (option)

LiDAT is a data transmission and positioning system which – by using the latest data transmission technology – can provide information on the machine location and its operation. Updated data can be retrieved several times daily and displayed in a web browser. Among other things, LiDAT can gather especially important information such as the equipment leaving a predefined zone or messages about specific operating states or individual parameters.

### Liebherr pipelayers as multifunctional units

- Liebherr pipelayers can be fitted with numerous auxiliary attachments for maintenance and rehabilitation tasks. The Liebherr pipelayer fulfils several functions, thus reducing the number of different machines needed on the construction site. This reduces the customer's operating costs considerably.

### Efficient conveyor belt shifter

Liebherr pipelayers are used around the world as conveyor belt shifters. Various customer-specific solutions simplify the operator's work considerably:

- Potentiometer for fine steering
- Hydraulic operation of all belt shifter functions
- Satellite-aided direction command and much more

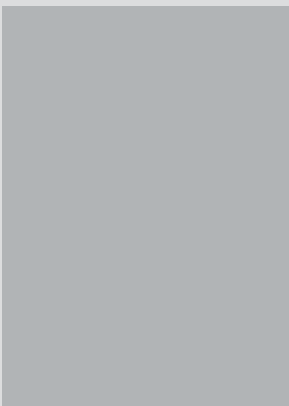

#### **Intuitive and precise single-joystick operation**

- Stepless control of the travel speed of the undercarriage on both sides up to turning on the spot (360°).
- Precision control function: 3-position rocker switch for fast, moderately sensitive or extremely sensitive motion control.
- Working in column: If several pipelayers are operating in unison, the required maximum travel speed required can be programmed via push-button.
- Memory function: All travel settings are retained after the machine is restarted.

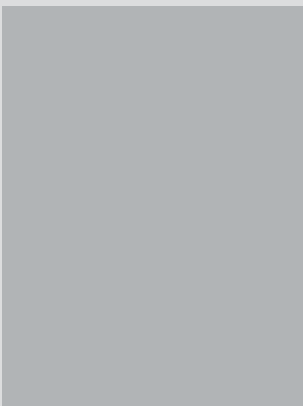

#### **Exceptional visibility of the working area**

- Large windows and the simultaneously slewing rope grab\* ensure very good visibility of the working area.

\* on RL 54 and RL 64

# Comfort

The new working environment offers exceptional operator comfort. With its generous space, the acoustically insulated and ergonomically designed cab provides the perfect conditions for fatigue-free and concentrated work. Outstanding visibility simplifies safe and precise movement of load as well.

## Intuitive single-joystick control

With one operating joystick each, the boom with winch and the entire travel drive can be controlled precisely and easily – including the „counter-rotation“ function. The logical operating concept requires only minimum training.

## Deluxe cab

**Digital instrument display** All instruments and operating controls are organised logically and easily reached. The front-mounted display instruments inform the operator about the current operating state of the pipelayer.

**Operator's seat angled toward the working area** The operator's seat has been angled 15° to the left toward the boom. This gives the operator the best view of the load being moved as well as of the pipelayers working in the column ahead and behind.

**Low noise level** Thanks to effective sound insulation and the quiet Liebherr diesel engines, the noise level of Liebherr pipelayers is especially low and less than legally mandated limits.

**Powerful heating and optional air-conditioning** Liebherr offers a powerful coolant-based heating system that – when used in conjunction with the optional air-conditioning system – creates a comfortable environment. A number of individually adjustable air vents supply the cab interior with fresh air and keep the temperature level constant from foot level to head region.

**Auxiliary heater** For extremely low ambient temperatures, a programmable auxiliary heater is optionally available.

## Perfect all-round visibility

**View to the right** Instead of a second winch, Liebherr uses a lifting cylinder for the boom. The right side of the machine is also kept very low, ensuring good visibility all-round.

**View to undercarriages on both sides** The ability to view the undercarriage on both sides is a major benefit for the operator, especially on narrow construction sites, when crossing bridges, or even when loading onto a transport trailer.

### Exemplary comfort

- To prevent operator strain, ergonomics received special attention when designing the cab.
- The large and lightly tinted cab windows offer the best view of the machine's surroundings.
- Angling the operator seat 15° to the left facilitates visual contact with the machine operator at the rear.

### View of the boom tip

- The integrated dormer window gives the operator a direct view of the boom tip and the position of the hook block.
- This makes passing beneath power lines simpler and safer.



**Torsion-resistant  
main frame**

- Use of high-quality steel grades as well as the box construction ensure that the main frame can withstand maximum loads over the long term.



**Key technologies  
from Liebherr**

- Hydraulic cylinders manufactured at Liebherr guarantee durability and reliability.
- Liebherr travel drives feature a double mechanical seal. A special sensor system monitors the condition of the seals and informs the operator of the condition.

# Reliability

Time-tested and proven technology as well as high material and manufacturing quality ensure maximum reliability even under the harshest conditions.

## Liebherr quality

### Rugged and well-thought-out design

The main frame is constructed using a proven box design. This gives it extremely high torsional stiffness and results in optimal absorption of the forces it encounters. Components subjected to high loads are manufactured from cast steel.

### Wear-free travel drive

The proven hydrostatic Liebherr travel drive does not need components such as a torque converter, manual gearbox differential steering or steering couplings. Standardised hydraulic pumps and motors operate reliably and practically without any wear.

### Long-lasting final drives

The heavy-duty final drives are extremely rugged and designed to handle maximum loads. Double mechanical seals with automatic monitoring for leaks ensure reliable operation.

### Hydrostatic fan drive

The hydrostatically powered fan regulates the cooling capacity to meet requirements. This allows the engine to reach the optimal operating temperature faster.

### Wide-meshed radiator

This prevents dirt build-up on the radiator.

### Hinged radiator guard

When working in environments with air high dust contamination levels, the hinged radiator guard provides fast access for cleaning.

### High-quality wiring

The wear-resistant, braided PVC-fibre cable sleeving with a Teflon core provides maximum protection against mechanical damage. Moisture uptake is also prevented.

### Low-temperature operation (option)

Liebherr pipelayers can be fitted with a variety of features to permit operation at low temperatures, e.g. preheating of the engine coolant, battery preheating, auxiliary cab heater, electrically heated fuel water separator or insulated windows.

### Endurance-tested components

- Component dimensions are established on the basis of finite element analysis and optimised for the loads encountered.
- All are subjected to intense endurance tests in the field. Only those parts that meet Liebherr's high quality standards are used in the machines.

### State-of-the-art cooling system

- Electronically controlled suction fans regulate the operating temperature of both the hydraulic oil and engine coolant. The individual components are kept within the ideal temperature range at all times – this protects the components and extends the service life.
- The cooling air is drawn in from clean regions, reducing contamination from dust particles.
- A reversible fan for cleaning the radiator automatically in environments with a high dust level in the air is available as an option.



**Numerous handholds on the machine**

- In keeping with the company's high safety standards, Liebherr pipe-layers feature numerous handholds.

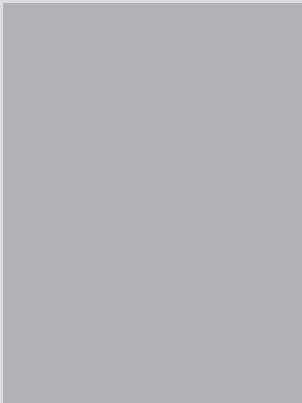

**Safe access to the cab**

- Ergonomically designed non-slip steps give the operator safe access to the cab.

**Pipe protection on the boom (option)**

- Heavy-duty rubber strips bolted to the boom protect the pipe against damage.



# Safety

Safety is a priority at Liebherr, which is why all pipelayers are based on a well-thought-out safety concept that sets standards in pipeline construction.

<b>Cab with integrated ROPS protection</b>	Liebherr pipelayer cabs come with integrated roll-over protection as a standard feature. This provides convenient and good visibility to the working area.
<b>Hydraulic cylinder for boom positioning</b>	Instead of a second winch, Liebherr installs a boom cylinder on all pipelayer models. This cylinder is maintenance-free and also prevents unintentional folding of the boom in critical situations.
<b>Logical joystick control</b>	All primary machine movements can be initiated intuitively and without reaching for another operating lever. This allows the operator to focus his attention on the load being moved at all times. Safety on the construction site is increased considerably as a result.
<b>Precision when travelling on slopes</b>	Liebherr pipelayers always move with no loss of traction. This prevents the machine's rolling away unintentionally, especially when travelling on slopes. When the machine is no longer moving, an automatically activated parking brake provides additional safety. Thanks to the hydrostatic system, the operator can control braking simply by eliminating any joystick deflection.
<b>Hose-break protection</b>	The boom cylinder on all Liebherr pipelayers features hose-break protection that prevents lowering of the boom in the event of pipe breakage.
<b>Overload warning device with automatic power cut-off (option)</b>	This monitoring function helps the operator recognise and avoid critical load situations. If the machine approaches the permissible load limit, automatic load-sensing power cut-off prevents further moment-increasing motions.
<b>Free-fall function</b>	If the operator must lower the load quickly, it is possible to switch the winch to free-fall.
<b>Backup alarm</b>	Liebherr pipelayers can be fitted with an audible alarm to signal when the machine is backing up.

## Automatic lift kick out

- When being raised, the hook block is stopped automatically just before coming into contact with the roller.

## Overload warning device with power cut-off

- The display in the cab informs the operator audibly and visually of the pipelayer's current load state.

## Well-thought-out lighting concept

- Numerous individually adjustable lights guarantee excellent illumination of the entire working area during multi-shift operation.

# Basic machine



## Engine

	RL 44	RL 54	RL 64
Liebherr diesel engine	D 936 L A6	D 936 L A6	D 946 L A6
	Emission regulations according to 97/68/EC, 2004/26/EC Stage IIIA and EPA/CARB Tier 3		
Rating (ISO 9249)	175 kW/238 HP	210 kW/286 HP	275 kW/374 HP
Rating (SAE J1349)	175 kW/235 HP	210 kW/282 HP	275 kW/368HP
Rated speed	1,800 1/min	1,800 1/min	1,800 1/min
Displacement	10.5 l / 641 in <sup>3</sup>	10.5 l / 641 in <sup>3</sup>	12 l / 733 in <sup>3</sup>
Design	6 cylinder in-line-engine (wet-sleeve) water-cooled, turbocharged, intercooled		
Injection system	Direct fuel injection, pump-line-nozzle system, electronic control		
Lubrication	Force-feed lubrication, engine lubrication in an inclined position up to 45°		
Operating voltage	24 V	24 V	24 V
Alternator 80 A	80 A	80 A	80 A
Starter	7.8 kW/11 HP	7.8 kW/11 HP	7.8 kW/11 HP
Batteries	2 x 170 Ah/12 V	2 x 180 Ah/12 V	2 x 225 Ah/12 V
Air cleaner	Dry-type air cleaner with safety element, aspirated pre-cleaner, service gauge in cab		
Cooling system	Combi radiator, comprising a radiator for water and charge air, hydrostatic fan drive		



## Travel drive, control

	RL 44	RL 54	RL 64
Transmission system	Infinitely variable hydrostatic travel drive, independent drive for each frame		
Travel speed*	Continuously variable		
Speed range 1 (reverse)	0– 4.0 km/h / 2.5 mph (4.8 km/h / 2.9 mph)		
Speed range 2 (reverse)	0– 6.5 km/h / 4.0 mph (7.8 km/h / 4.8 mph)		
Speed range 3 (reverse)	0–10.5 km/h / 6.5 mph (10.5 km/h / 6.5 mph)		
	* Pre-adjusted, all speed ranges can be customised on the travel joystick (memory function)		
Drawbar pull	300 kN at 1.7 km/h / 1.1 mph	387 kN at 1.6 km/h / 1.0 mph	510 kN at 1.5 km/h / 0.9 mph
Electronic control	Electronic engine speed sensing control (load sensing feature) automatically adjusts travel speed and drawbar pull to match changing load conditions		
Steering	Hydrostatic		
Service brake	Wear-free, hydrostatic (dynamic braking)		
Automatic park brake	Wear-free, wet multiple-disc brakes, automatically applied with neutral joystick position		
Cooling system	Hydraulic oil cooler integrated in combi radiator	Separate hydraulic oil cooler hydrostatically driven and thermostatically controlled	
Filter system	Micro cartridge filters in replenishing pressure circuit		
Final drive	Heavy-duty combination spur gear with planetary final drives, double sealed with electronic seal-integrity indicator		
Control	Single-lever for all travel and steering motions, as well as for counter rotation		



## Operator's cab

	RL 44	RL 54	RL 64
Cab	Resiliently mounted cab with positive pressure ventilation, can be tilted with hand pump 40° to the rear. With ROPS Rollover Protective Structure (ISO 3471)		
Operator's seat	Comfort seat, adjustable to operator's weight		
Monitoring	Combined analogue / LC display, automatic monitoring, display of abnormal operating conditions		



## Undercarriage

	RL 44	RL 54	RL 64
Design	Track frame, rigid		
Mount	Elastic components at a separate pivot		
Chains	Lubricated, single-bar grouser shoes, track chain tension via grease tensioner and hydraulic cylinders		
Links, each side	43	45	48
Track rollers/ carrierrollers	8/2 each side	9/2 each side	9/2 each side
Sprocket segments	5 each side	5 each side	5 each side
Track shoes	914 mm / 36"	914 mm / 36"	914 mm / 36"
	711 mm / 28"	914 mm / 36"	914 mm / 36"



## Hydraulic system

	RL 44	RL 54	RL 64
System	Load Sensing proportional pump flow control		
Pump type	Swash plate, variable displacement piston pump		
Pump flow max.	283 l/min / 62.3 gpm		
Pressure limitation	280 bar / 4,060 PSI		
Control valve	3 segments, expandable to 4		
Filter system	Return filter with magnetic rod in the hydraulic tank		
Control	Single joystick for hoist winch and adjustable boom cylinder, free fall device of hook in case of danger. Further single joystick for counterweight.		



## Hydraulic winch

	RL 44	RL 54	RL 64
Hoist winch	Variable flow hydraulic pump		
Safety brake	Spring-loaded disk brake holds the load safely in any position		
Drum diameter	254 mm/10"	254 mm/10"	254 mm/10"
Drum length	279 mm/10.98"	274 mm/10.79"	279 mm/10.98"
Flange diameter	610 mm/24"	610 mm/24"	610 mm/24"
Cable diameter	20 mm/0.8"	20 mm/0.8"	20 mm/0.8"
Cable length	65 m/71.08 yd	80 m/87.49 yd	100 m/109.36 yd
Hook block	2 sheaves	3 sheaves	4 sheaves
Hook speed (up,down)	0–30.2 m/min, 0–99 ft/min	0–20.0 m/min, 0–66 ft/min	0–16.0 m/min, 0–52 ft/min
Security	Free fall device		



## Drawbar pull

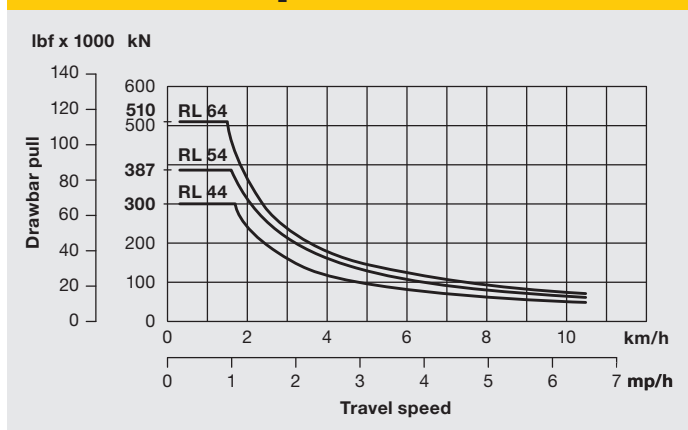

Usable drawbar pull will depend on traction and weight of pipelayer

# Basic machine



## Noise emission

	RL 44	RL 54	RL 64
Operator sound exposure (ISO 6396:2008)	$L_{pA} = 78$ dB(A) (emission at the operator's position)	$L_{pA} = 78$ dB(A) (emission at the operator's position)	$L_{pA} = 78$ dB(A) (emission at the operator's position)
Exterior sound pressure (2000/14/EC)	$L_{wA} = 108$ dB(A) (emission in the environment)	$L_{wA} = 108$ dB(A) (emission in the environment)	$L_{wA} = 108$ dB(A) (emission in the environment)



## Refill capacities in Imp. Gallons

	RL 44	RL 54	RL 64
Fuel tank	400 l/88 gallons	535 l/117.7 gallons	650 l/143 gallons
Cooling system	55 l/12.1 gallons	62 l/13.6 gallons	74 l/16.3 gallons
Engine oil with oil filters	43 l/9.5 gallons	43 l/9.5 gallons	43 l/9.5 gallons
Splitter box	3.1 l/0.7 gallons	6.5 l/1.4 gallons	6.3 l/1.4 gallons
Hydraulic tank	126 l/27.7 gallons	169 l/37.2 gallons	215 l/47.3 gallons
Final drive, left	21 l/4.6 gallons	19.5 l/4.3 gallons	26 l/5.7 gallons
Final drive, right	14 l/3.1 gallons	19.5 l/4.3 gallons	26 l/5.7 gallons

# Dimensions and weights

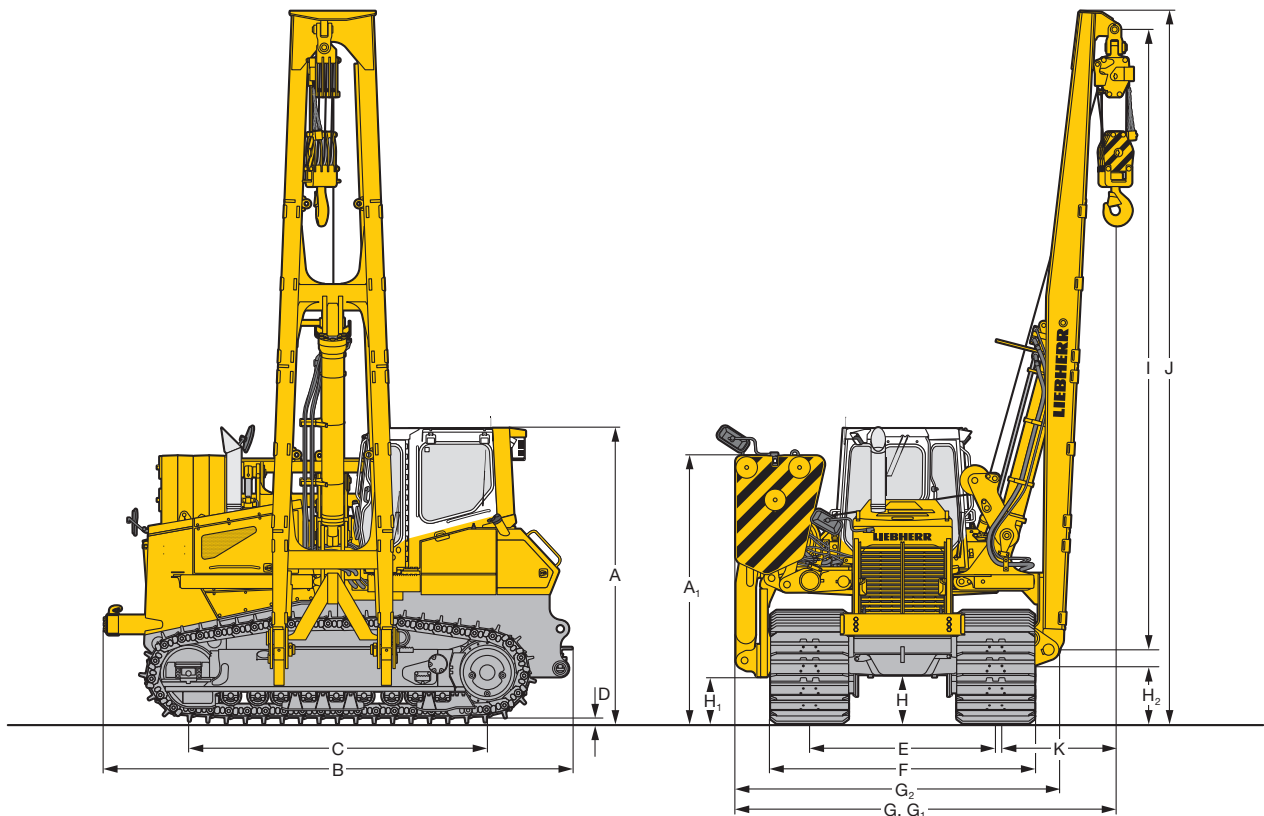

Dimensions		RL 44		RL 54		RL 64	
		Standard	Optional	Standard	Optional	Standard	Optional
	Boom	6,000 mm	7,320 mm	7,300 mm	8,500 mm	8,500 mm	10,500 mm
A	Height over cab	3,226 / 10'7"		3,464 / 11'4"		3,555 / 11'8"	
A1	Height over counterweight	2,876 / 9'5"		3,068 / 10'1"		3,543 / 11'7"	
B	Overall length	5,146 / 16'11"		5,446 / 17'10"		5,795 / 19'0"	
C	Distance idler/sprocket center	3,315 / 10'11"		3,504 / 11'6"		3,610 / 11'10"	
D	Height of grousers	71.5 / 2.81"		71 / 2.8"		84 / 3.31"	
E	Track gauge	2,075 / 6'10"		2,180 / 7'2"		2,510 / 8'3"	
F	Total width over undercarriage	2,887 / 9'6"		3,094 / 10'2"		3,348 / 11'0"	
G	Width (counterweight retracted)	4,104 / 13'6"		3,785 / 12'5"		5,651 / 18'6"	
G1	Width (counterweight extended)	5,745 / 18'10"		5,544 / 18'2"		7,291 / 23'11"	
G2	Width (console to boom)	3,565 / 11'8"		3,785 / 12'5"		4,245 / 14'0"	
H	Ground clearance	461 / 1'6"		501 / 1'8"		552 / 1'10"	
H1	Ground clearance of console	573 / 1'11"		548 / 1'10"		565 / 1'10"	
H2	Ground clearance of boom	674 / 2'3"		747 / 2'5"		682 / 2'3"	
I	Boom length	6,000 / 19'8"	7,320 / 24'	7,300 / 23'11"	8,500 / 27'11"	8,500 / 27'11"	10,500 / 34'5"
J	Total height	6,999 / 1'6"	7,319 / 24'	8,281 / 27'2"	9,481 / 31'1"	9,515 / 31'3"	11,515 / 37'9"
K	Distance (outer edge of chain link to hook)	1,178 / 3'10"		1,200 / 3'11"		1,380 / 4'6"	
	Operating weight	35,100/77,382	35,360/77,955	45,900/101,192	46,133/101,706	58,800/129,632	59,349/130,842
	Counterweight without frame	5,030 / 11,089		9,534 / 21,019		12,000 / 26,455	
	Counterweight	7,222 / 15,922		12,730 / 28,065		15,985 / 35,241	
	Weight of standard boom	1,701 / 3,750	1,961 / 4,323	2,264 / 4,991	2,497 / 5,505	3,305 / 7,286	3,854 / 8,497

# Dimensions and weights

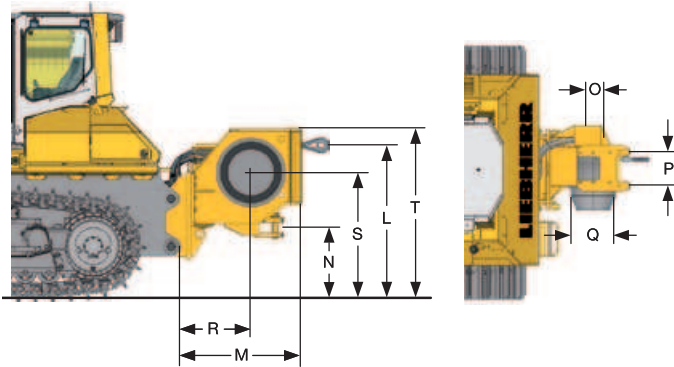

## Winch

		RL 44	RL 54	RL 64	
L	Height, cable exit	mm/ft-in	1,571 / 5'2"	1,565 / 5'2"	1,608 / 5'3"
M	Overall length	mm/ft-in	1,203 / 3'11"	1,200 / 3'11"	1,180 / 3'10"
N	Height drawbar	mm/ft-in	763 / 2'6"	757 / 2'6"	800 / 2'7"
O	Drum diameter	mm/ft-in	318 / 1'1"	318 / 1'1"	318 / 1'1"
P	Coiling width	mm/ft-in	337 / 1'1"	337 / 1'1"	337 / 1'1"
Q	Flange diameter	mm/ft-in	610 / 2'0"	610 / 2'0"	610 / 2'0"
R	Distance to center of drum	mm/ft-in	696 / 2'3"	639 / 2'1"	673 / 2'2"
S	Height of drum center	mm/ft-in	1,314 / 4'4"	1,308 / 4'3"	1,351 / 4'5"
T	Total height	mm/ft-in	1,763 / 5'9"	1,757 / 5'9"	1,800 / 5'11"
Max. line pull		kN/lb		577 / 129,669	
Max. line speed		m/min / yd/min		0 - 30 / 32.81	
Cable diameter		mm/ft-in		28 / 1.1"	
Cable length		mm/in		60 / 65.62	
Weight		kg/lb	2,565 / 5,655	2,600 / 5,732	2,650 / 5,842

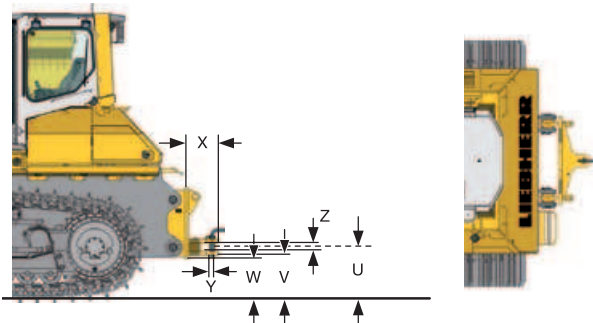

## Drawbar, rigid

		RL 44	RL 54	RL 64	
U	Height of drawbar	mm/ft-in	542 / 1'9"	576 / 1'11"	620 / 2'0"
V	Ground clearance below drawbar	mm/ft-in	454 / 1'6"	474 / 1'7"	517 / 1'8"
W	Ground clearance below drawbar suspension	mm/ft-in	429 / 1'5"	424 / 1'5"	467 / 1'6"
X	Overall length	mm/ft-in	413 / 1'4"	435 / 1'5"	455 / 1'6"
Y	Pin diameter	mm/in	50 / 1.97"	60 / 2.36"	60 / 2.36"
Z	Size of opening	mm/in	95 / 3.74"	105 / 4.13"	105 / 4.13"
Weight		kg/lb	212 / 467	460 / 1'6"	577 / 1,272

# Transport dimensions and weights

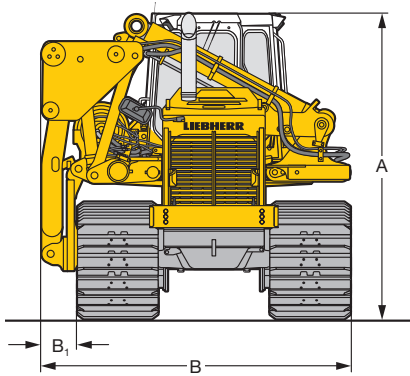

Pos. 1

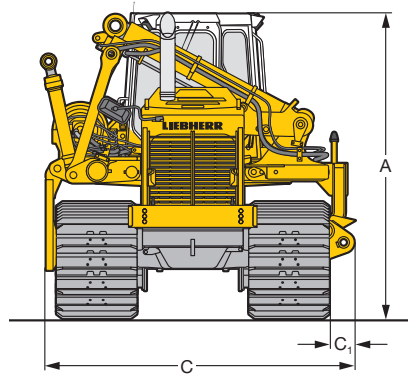

Pos. 2

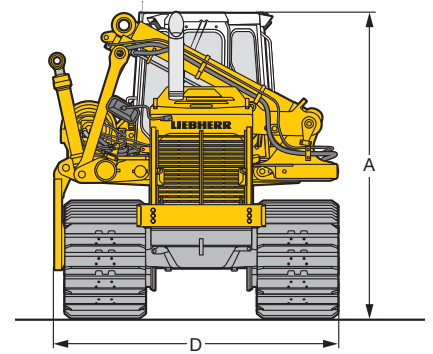

Pos. 3

## Transport dimensions, displayed position

		RL 44	RL 54	RL 64
A Total height	mm/ft-in	3,467/11'4"	3,464 / 11'4"	3,639/11'11"
B Overall width	mm/ft-in	3,283/10'9"	3,500 / 11'6"	3,935/12'11"
B <sub>1</sub> Width (from console to left track)	mm/ft-in	395 / 1'4"	406 / 1'4"	481 / 1'7"
Weight (Pos. 1)	kg/lb	27,898/61,504	33,656 / 74,199	42,590/93,895
C Overall width	mm/ft-in	3,189/10'6"	3,497 / 11'6"	3,824/12'7"
C <sub>1</sub> Width (from console to right track)	mm/in	192 / 7.56"	285 / 11.22"	327 / 12.87"
Weight (Pos. 2)	kg/lb	26,555/58,544	31,690 / 69,864	40,102/88,410
D Overall width	mm/ft-in	2,997/9'10"	3,212 / 10'6"	3,497/11'6"
Weight (Pos. 3)	kg/lb	26,084/57,505	31,023 / 68,394	39,219/86,463

# Lift capacity RL 44 (ISO 8813)

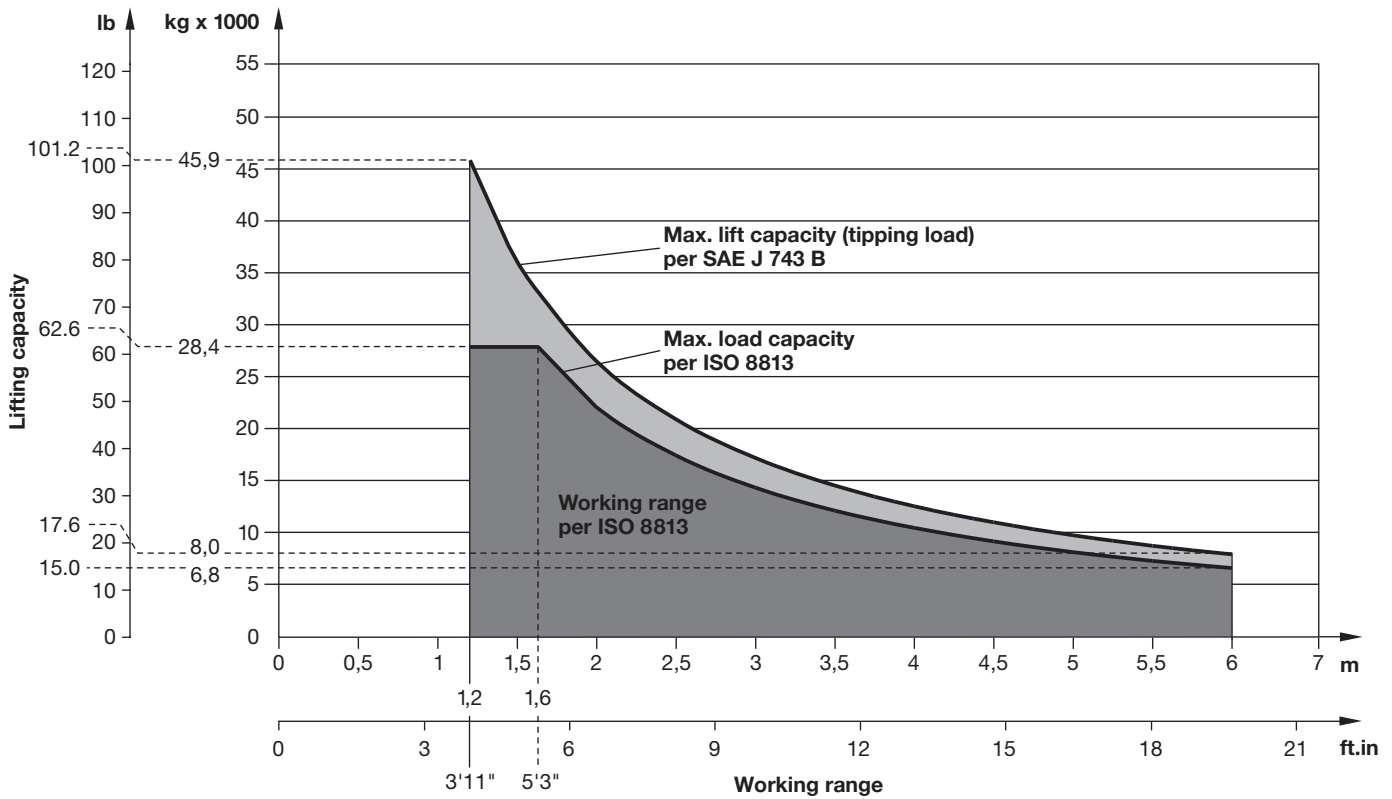

# Ground pressure RL 44 (ISO 8813)

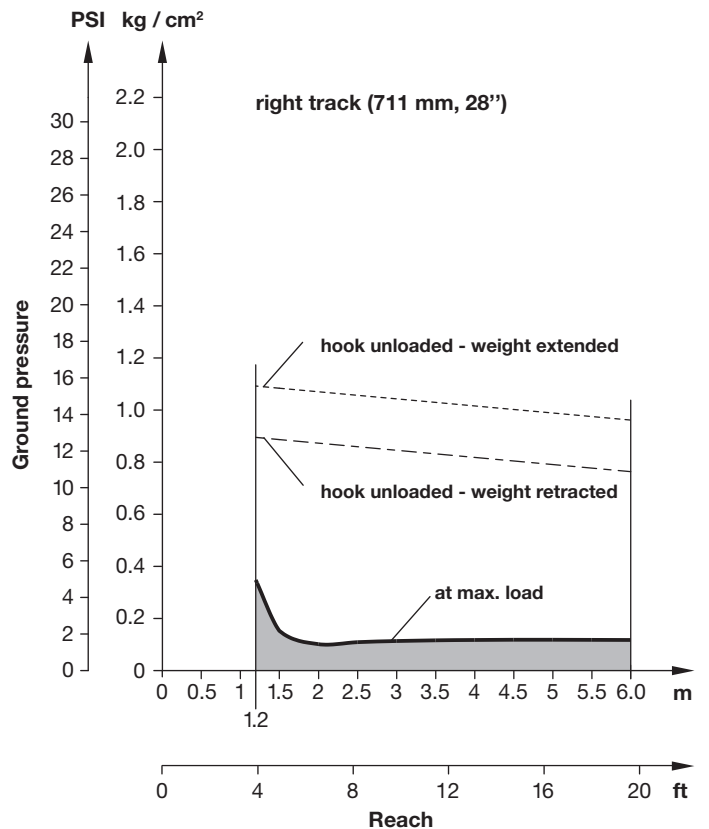
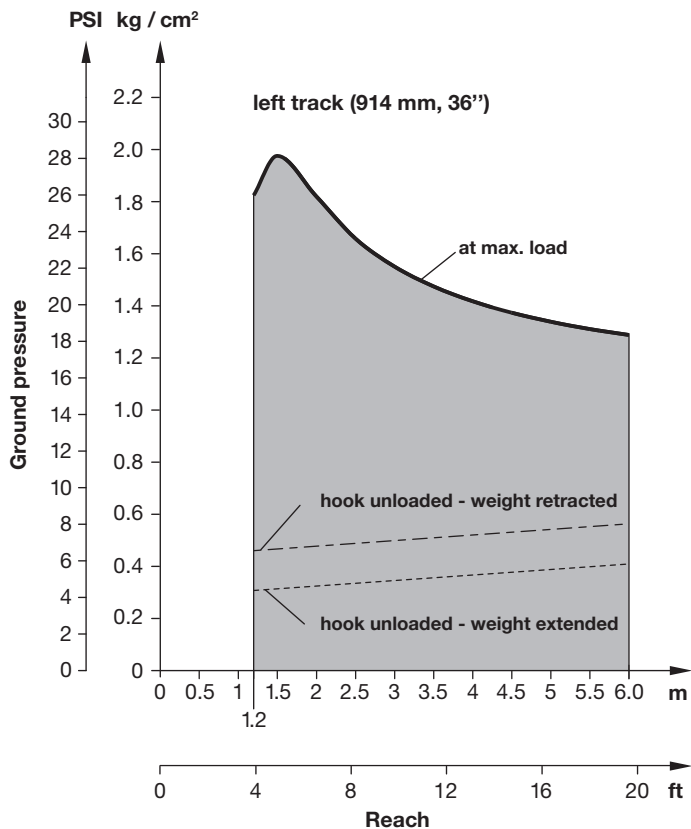

With standard boom 6,000 mm / 19'8"

# Lift capacity RL 54 (ISO 8813)

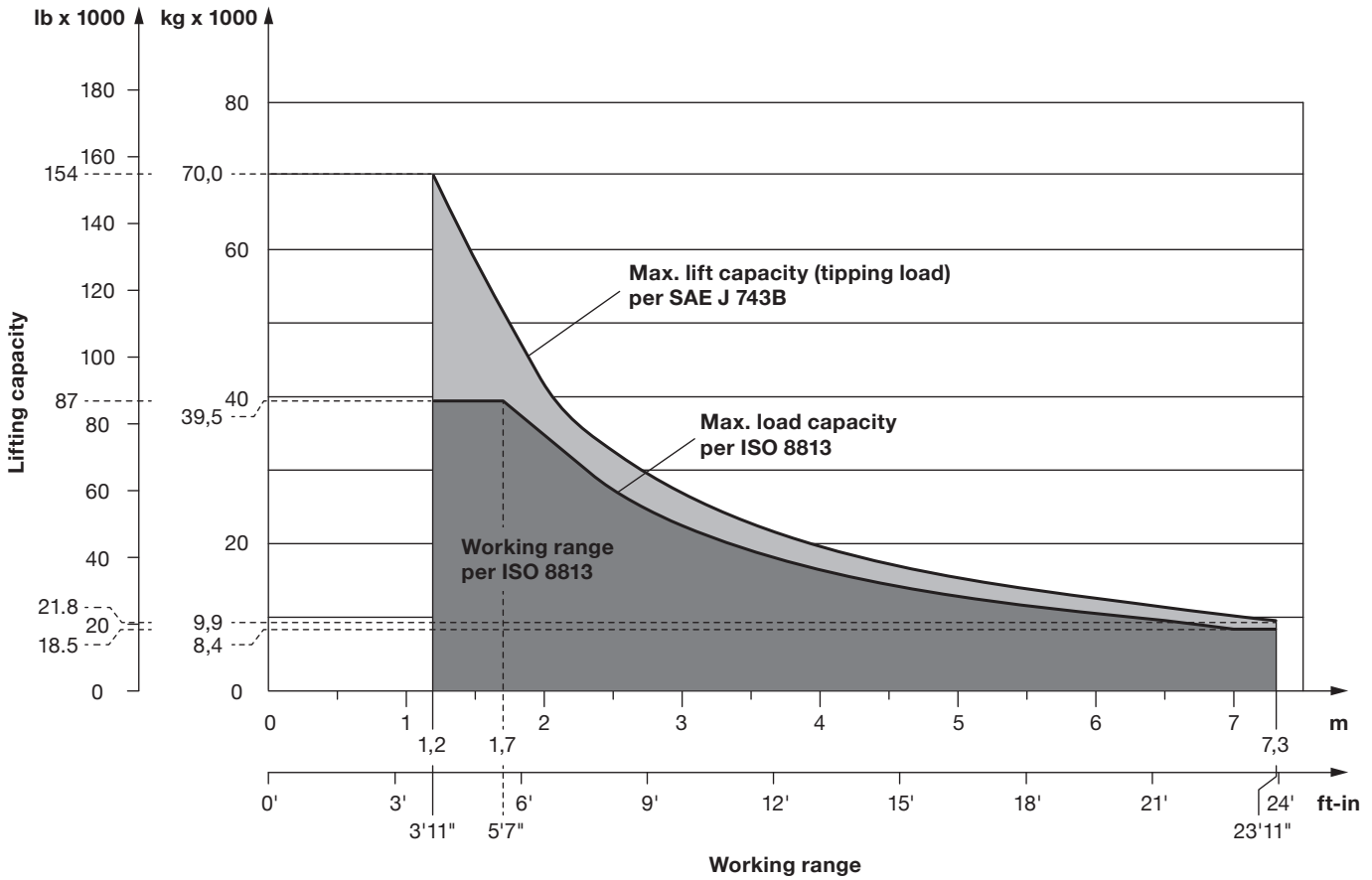

# Ground pressure RL 54 (ISO 8813)

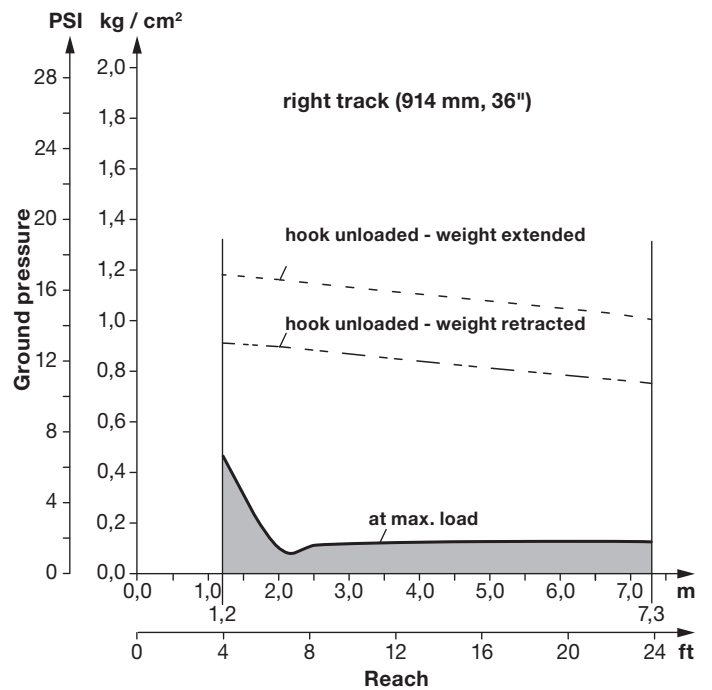
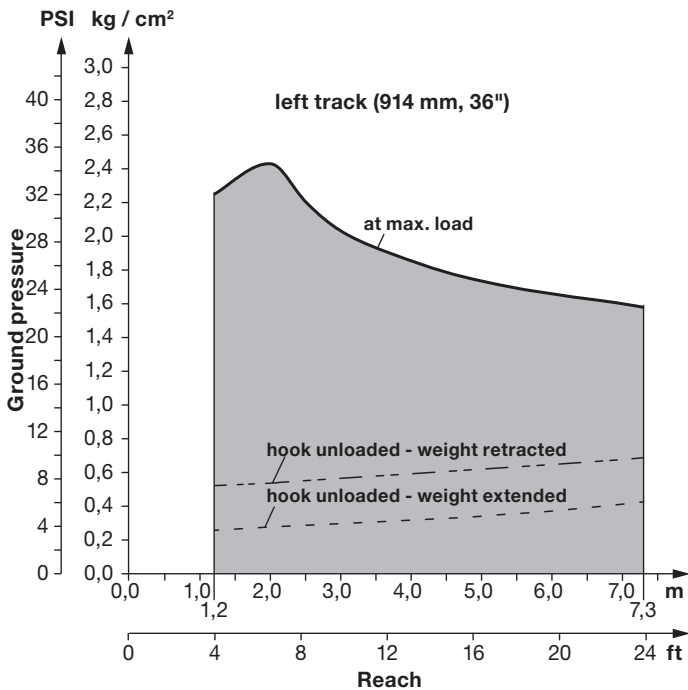

With standard boom 7,300 mm / 23'11"

# Lift capacity RL 64 (ISO 8813)

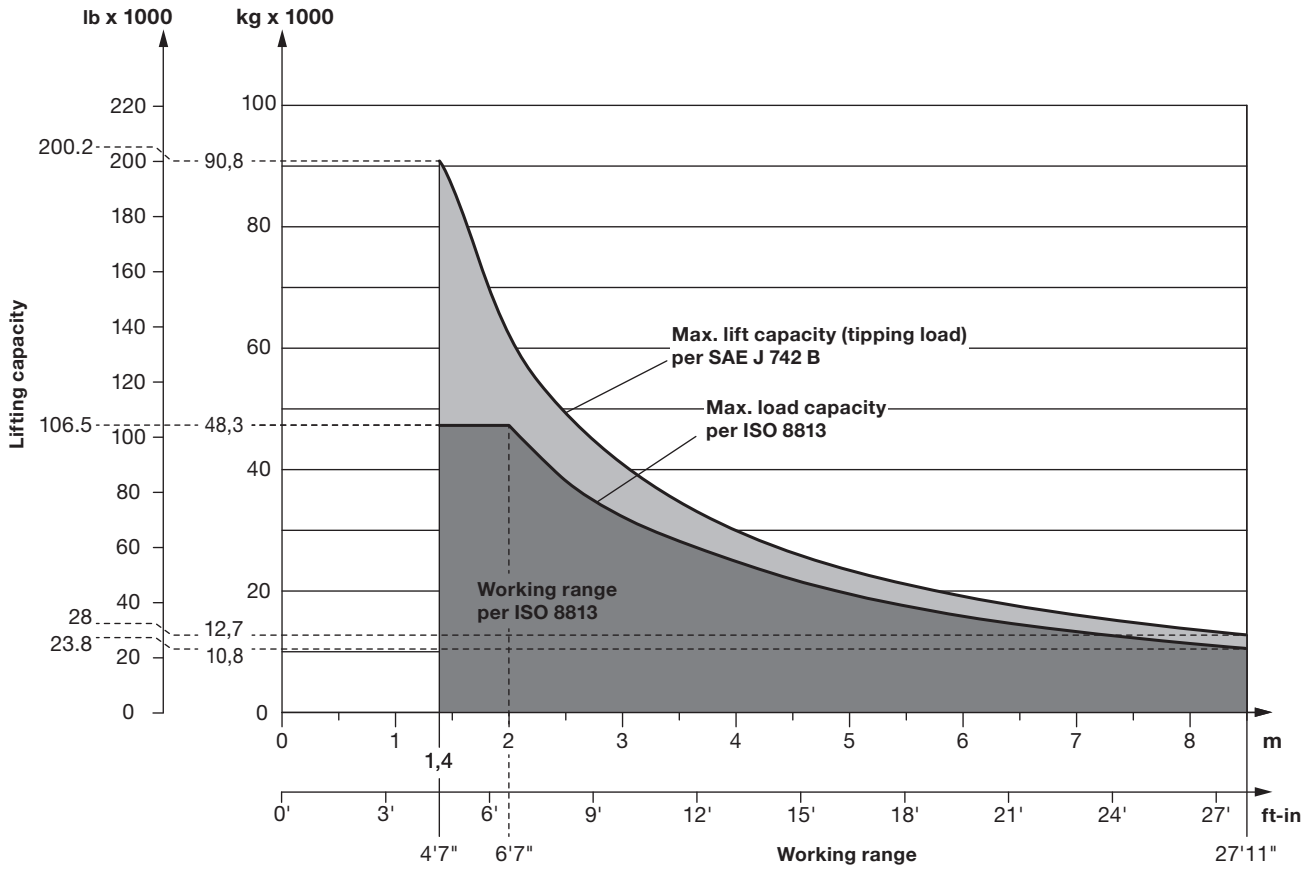

# Ground pressure RL 64 (ISO 8813)

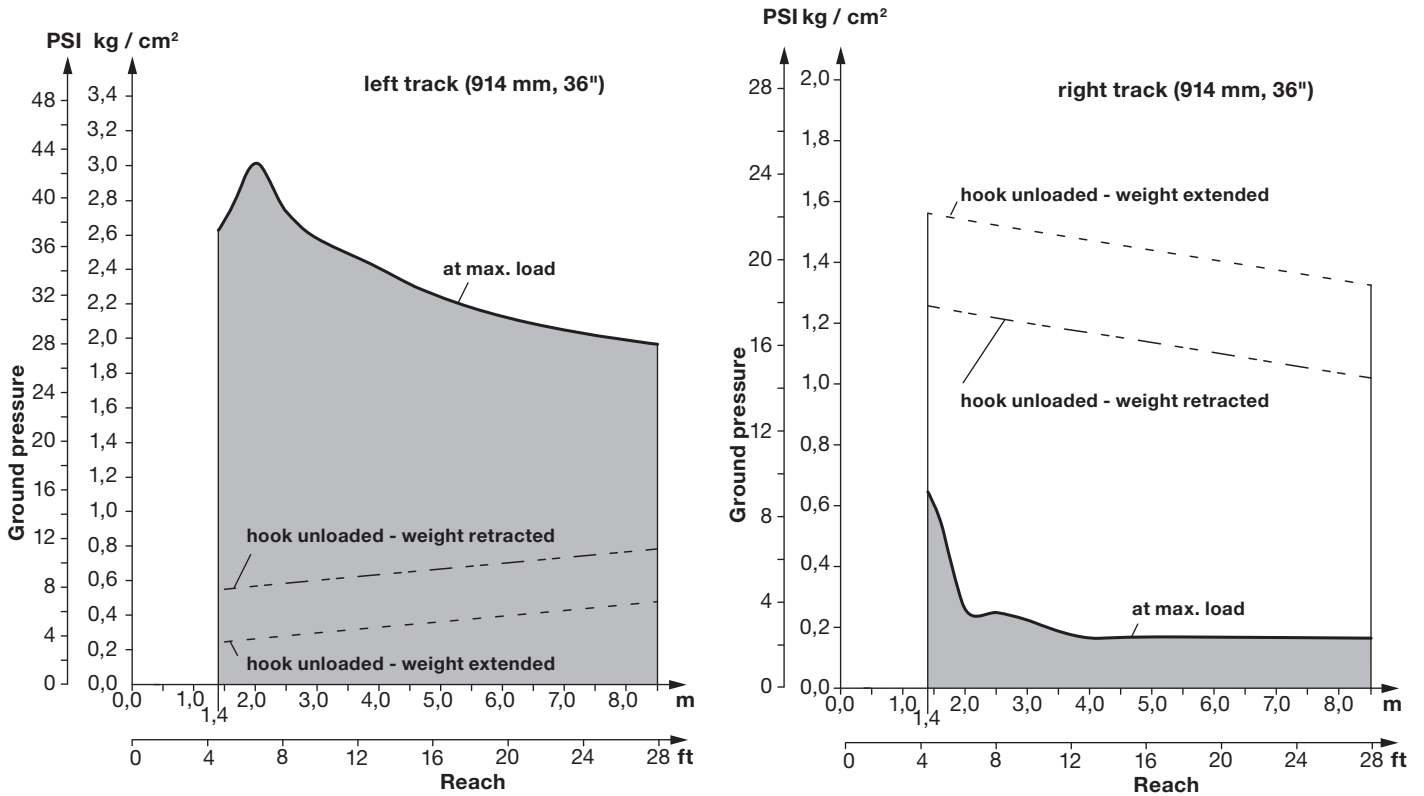

With standard boom 8,500 mm / 27'11"



# Equipment



## Basic machine

Tow switch	•
Towing hitch rear	•
Towing lug front	•
Battery compartment, lockable	•
Belly pans, heavy-duty	•
Radiator, wide-meshed	•
Radiator guard, heavy-duty	•
Radiator guard, hinged	•
Liebherr diesel engine	•
Fan, hydraulically driven	•
Fan guard	•
Engine cover, perforated	•
Engine doors, perforated	•
Engine doors, hinged, lockable	•
Fuel water separator	•
Air filter dry-type, dual step	•
Pre-cleaner with automatic dust ejector	•
Toolkit	•
-40°C kit	+
Refuelling pump, electric	+
GOST labelling	+
LiDAT Plus – Data transmission system	+
Lugs for crane lifting	+
Special paint	+
Fuel water separator with electric heater	+



## Travel drive

Parking brake, automatic	•
Function control, automatic	•
Control, single joystick	•
Load limit control, electronic	•
Electronic control	•
Travel control 3-speed ranges	•
Hydrostatic travel drive	•
Oil cooler	•
Final drives with planetary gear	•
Safety lever	•
Emergency stop	•
Inching brake pedal	+



## Undercarriage

Track frame, closed	•
Sprocket segments, bolted	•
Master link, two-piece	•
Tracks oil lubricated	•
Track frame, rigid	•
Pivot shaft, separate	•
Track guide centre part	+
Track guard	+



## Electrical system

Starter motor	•
Working lights, front, 2 units	•
Working lights, rear, 2 units	•
Working lights, side 2 units	•
Working light, winch, 2 units	•
Batteries, cold start, 2 units	•
Battery main switch, mechanical	•
On-board system 24 V	•
Alternator 80 A	•
Back-up alarm	•
Horn	•
Beacon	+
Start lock, electronic	+
Additional lights, rear	+



## Operator's cab

Storage compartment front	•
Armrests 3D adjustable	•
Pressurised cab	•
Operator's seat, 6-way adjustable	•
Dome light	•
Coat hook	•
ROPS	•
Rear mirror, inside	•
Safety glass, tinted	•
Windshield wiper left door and left window	•
Windshield wipers front, rear	•
Dormer window	•
Sun visor front	•
Socket 12 V	•
Warm water heating	•
Operator's seat, air-suspended	+
Fire extinguisher in cabine	+
Air conditioning	+
FM radio	+
Radio installation kit	+
Windshield wiper dormer window	+
Extension, seat back	+



## Control and warning lights

Control travel speed range (digital)	•
Control engine coolant temperature (analogue)	•
Fuel gauge (analogue)	•
Hour meter (analogue)	•
Warning light battery charging	•
Warning light diesel engine	•
Warning light electronic travel control system	•
Warning light travel drive seal, each side	•
Warning light parking brake	•
Warning light pump replenishing pressure	•
Warning light oil return filter	•
Warning light air filter	•
Warning light heater Diesel engine	•
Main warning light	•
Warning hydraulic oil temperature	+
Overload warning system	+



## Hydraulic system

Hydraulic control counterweight	•
Hydraulic control winch and boom	•
Variable flow pump, load sensing	•
Oil filter with strainer in hydraulic tank	•
Free fall device	•
Hydraulic servo control	•
Control valve for 1 circuit	+
Hydraulic tank oil level control	+



## Attachments

Boom RL 44 6,000 mm/19'8"	•
Boom RL 54 7,300 mm/23'11"	•
Boom RL 64 8,500 mm/27'11"	•
Counterweight	•
Hook with rope	•
Boom RL 44 7,320 mm/24'	+
Boom RL 54 8,500 mm/27'11"	+
Boom RL 64 10,500 mm/34'5"	+
Boom protection strips	+
Drawbar rear, rigid	+
Counterweight, rear	+
Winch rear	+

• = standard

+ = option

Änderungen vorbehalten.

Options and/or special attachments, supplied by vendors other than Liebherr, are only to be installed with the knowledge and approval of Liebherr to retain warranty.

# The Liebherr Group of Companies



## Wide Product Range

The Liebherr Group is one of the largest construction equipment manufacturers in the world. Liebherr's high-value products and services enjoy a high reputation in many other fields. The wide range includes domestic appliances, aerospace and transportation systems, machine tools and maritime cranes.

## Exceptional Customer Benefit

Every product line provides a complete range of models in many different versions. With both their technical excellence and acknowledged quality, Liebherr products offer a maximum of customer benefits in practical application.

## State-of-the-art Technology

To provide consistent, top quality products, Liebherr attaches great importance to each product area, its components and core technologies. Important modules and components are developed and manufactured in-house, for instance the entire drive and control technology for construction equipment.

## Worldwide and Independent

Hans Liebherr founded the Liebherr family company in 1949. Since that time, the enterprise has steadily grown to a group of more than 130 companies with over 38,000 employees located on all continents. The corporate headquarters of the Group is Liebherr-International AG in Bulle, Switzerland. The Liebherr family is the sole owner of the company.

[www.liebherr.com](http://www.liebherr.com)

## Liebherr-Werk Telfs GmbH

Hans Liebherr-Straße 35, A-6410 Telfs

☎ +43 50809 6-100, Fax +43 50809 6-7772

[www.liebherr.com](http://www.liebherr.com), E-Mail: [lwt.marketing@liebherr.com](mailto:lwt.marketing@liebherr.com)

[www.facebook.com/LiebherrConstruction](https://www.facebook.com/LiebherrConstruction)

*Courtesy of Machine.Market*