

# LOCATELLI

CRANE



GRIL 55.50  
MEDIUM DUTY



## CARRO

### TELAIO

Scatolato con nervature interne costruito con acciai ad alta resistenza.

### STABILIZZATORI

Quattro stabilizzatori idraulici movimentati da cilindri orizzontali e martinetti con valvole di blocco. Escursione travi in tre posizioni: 0%, 50% e 100%. Piedi di appoggio facilmente removibili. Comandi ed indicatore di livello posti in cabina.

### MOTORE

Diesel, turbo intercooler a controllo elettronico e raffreddamento ad acqua. Filtro aspirazione aria a secco con cartuccia di sicurezza e indicatore di intasamento.

### TRASMISSIONE

Convertitore di coppia con cambio Powershift con sei marce in avanti e sei retromarce.

### POMPE IDRAULICHE

Ad ingranaggi azionata dalla presa di forza sul convertitore.

### ASSALI

Anteriore: traente/sterzante con differenziale e mozzi con riduzioni planetarie, montato rigidamente sul telaio.

Posteriore: traente/sterzante con differenziale e mozzi con riduzioni planetarie, oscillante per l'impiego fuoristrada o bloccato in posizione orizzontale per l'impiego su gomme.

### STERZO

Anteriore: azionato idraulicamente tramite il volante.

Posteriore: azionato idraulicamente con interruttore elettrico, indipendente dall'assale anteriore, con indicatore di allineamento ruote.

Quattro modalità di sterzata: solo ruote anteriori, solo ruote posteriori, coordinata, a granchio.

### FRENI

Servizio/Emergenza: pneumatico a doppio circuito indipendente azionato a pedale su tutte le ruote.

Stazionamento: con cilindro a molla agenti sulle ruote anteriori.

### PNEUMATICI

Tipo "fuoristrada", montati in singolo.

### IMPIANTO ELETTRICO

Due batterie da 12V / 160A. Avviamento e illuminazione a 24 V.

## CARRIER

### CARRIER FRAME

Box section frame with internal ribs fabricated from high-strength steel.

### OUTRIGGERS

Four hydraulic outriggers moved by horizontal cylinders and jacks with hold valves. Excursion of the beams in three positions: 0%, 50% and 100%. Easily removable floats. Controls and bull's eye spirit level placed in the cabin.

### ENGINE

Diesel, turbo intercooler, electronically controlled and water cooling. Dry type air cleaner with safety cartridge and clogging indicator.

### TRANSMISSION

Torque converter with Powershift gearbox with six forward gears and six reverse gears.

### HYDRAULIC PUMPS

Gear type, driven from power-take-offs mounted on torque converter.

### AXLES

Front: drive/steer axle with differential and hubs with planetary reduction, rigidly mounted on the carrier frame.

Rear: drive/steer axle with differential and hubs with planetary reduction, pivot for off-road use or locked in a horizontal position for the use on tyres.

### STEERING

Front: hydraulically operated by steering wheel.

Rear: hydraulically operated by an electrical switch, independent from the front axle, with wheel alignment indicator.

Four steering modes: only front wheels, only rear wheels, coordinated, crab.

### BRAKES

Service/Emergency: dual independent pneumatic circuit operated by pedal acting on all wheels.

Parking: with spring cylinder acting on the front wheels.

### TYRES

"Off-road" type, single mounted.

### ELECTRICAL EQUIPMENT

Two 12V / 160A batteries. Starting and lighting at 24 V.

## CHASSIS

### CHASSIS

Structure en acier à haute résistance, entièrement soudée.

### STABILISATEURS

Quatre stabilisateurs hydraulique à 4 poutres horizontales et 4 vérins verticaux munis de clapets anti-retour. Extensions des poutres en trois positions : 0%, 50% et 100%. Patins de calage amovibles. Commandes et jauge en cabine.

### MOTEUR

Diesel turbo avec intercooler, refroidissement à eau. Filtre à air à sec muni de cartouche de sécurité et indicateur de colmatage.

### TRANSMISSION

Ensemble convertisseur de couple et boîte Powershift à 6 rapports AV et 6 AR.

### POMPES HYDRAULIQUES

A engrenages entraînées par prise de force sur le convertisseur.

### ESSIEUX

Avant: moteur et directeur avec différentiel et réduction planétaire, monté rigide sur châssis.

Arrière: moteur et directeur avec différentiel et réduction planétaire articulé sur châssis pour une utilisation hors route ou verrouillage en position horizontale pour une utilisation sur roues.

### DIRECTION

Avant: Hydraulique commandée par le volant. Arrière: Commande hydraulique avec interrupteur électrique, indépendant de l'essieu antérieur, avec indicateur d'alignement des roues.

Quatre modes de direction: uniquement roues antérieures, uniquement roues postérieures, coordonnées, en crabe.

### FREINS

Service/Emergence: pneumatique à double circuit indépendant commandé par pédale agissant sur toutes les roues.

Parking: Avec cylindre à ressort agissant sur l'essieu AV.

### PNEUS

Type tout-terrain montés simple AV et AR.

### CIRCUIT ELECTRIQUE

Deux batteries de 12V / 160A. Démarrage et éclairage 24 V.

## TORRETTA

### STRUTTURA TORRETTA

Costruita con piastre e profilati in acciaio ad alta resistenza.

### BRACCIO TELESCOPICO

A sezioni scatolate azionato idraulicamente e sincronizzato. Sistema di sfilamento proporzionale.

### SOLLEVAMENTO BRACCIO

Cilindro idraulico a doppio effetto con valvola di blocco.

### ARGANO PRINCIPALE

Motore idraulico a pistoni accoppiato a riduttore a riduzione epicicloidale. Tamburo scanalato. Freno negativo a dischi multipli e valvola di controbilanciamento.

### ROTAZIONE TORRETTA

Motore idraulico accoppiato a riduttore a riduzione epicicloidale. Freno di rotazione negativo a dischi multipli. Sistema di rotazione libera. Rotazione continua a 360°. Inserimento manuale del perno di bloccaggio della rotazione in cabina.

### CABINA

Costruita in acciaio e sospesa elasticamente sul lato sinistro della torretta. Ampi vetri di sicurezza a visibilità panoramica con possibilità di apertura vetri anteriore e posteriore. Due lava/tergicristalli elettrici. Sedile ergonomico scorrevole e regolabile in altezza, in profondità e secondo il peso dell'operatore. Cintura di sicurezza. Riscaldamento indipendente.

### COMANDI GRU

Manipolatori idraulici integrati nei braccioli del sedile dell'operatore per il comando indipendente o simultaneo dei movimenti gru. Interruttori elettrici per il comando degli stabilizzatori, della marcia veloce dell'argano e della rotazione libera.

### DISTRIBUTORI

Distributori idraulici individuali che garantiscono la combinazione simultanea dei movimenti della gru. Sistema centralizzato per il controllo delle pressioni idrauliche.

### COMANDI TRASLAZIONE GRU

Volante per il comando della sterzata ruote anteriori. Interruttore elettrico per la sterzata indipendente delle ruote posteriori.

Cambio manuale e freno di parcheggio. Interruttore elettrico per il comando delle marce lente e veloci con inserimento automatico delle 2 o 4 ruote motrici. Strumentazione di allarme motore.

### LIMITATORE DI CARICO

Limitatore con display 8" touchscreen a colori con grafica personalizzabile. Sistema anti-two block con allarme acustico e visivo e bloccaggio dei movimenti gru. Sistema di riconoscimento angolo e sfilo braccio. Trasduttori di pressione sul cilindro di sollevamento. Riconoscimento automatico della configurazione degli stabilizzatori.

### DISPOSITIVI DI SICUREZZA

Fincorsa discesa gancio. Dispositivo di taglio movimenti. Valvole di blocco su tutti i cilindri. Valvole di massima pressione su tutti i circuiti idraulici.

## UPPER STRUCTURE

### UPPER STRUCTURE FRAME

Fabricated with high-strength steel plates and profiles.

### TELESCOPIC BOOM

Box sections hydraulically operated and synchronised. Proportional extension system.

### BOOM ELEVATION

Double acting hydraulic cylinder with hold valve.

### MAIN HOIST

Gear hydraulic motor coupled to a reduction planetary gear. Grooved drum. Multi-disc negative brake and counterbalancing valve.

### SLEWING

Hydraulic motor coupled to a double reduction planetary gear. Slewing multi-disc negative brake. Free slewing system. 360° non-stop rotation. Manual engagement of the slewing lock-pin from the cabin.

### CABIN

Fabricated in steel and elastically suspended on the left side of the turret. Wide safety panoramic view windscreens with possibility of opening front and rear window panes. Two electric screen washers/wipers. Ergonomic sliding seat adjustable in height, depth and according to the operator's weight. Safety belt. Independent heating.

### CRANE CONTROLS

Hydraulic joysticks integrated in the armrests of the operator's seat for independent or simultaneous control of the crane manoeuvres. Electric switches for the control of the outriggers, the hoist fast speed and the free slewing.

### DISTRIBUTORS

Individual hydraulic distributors that ensure the simultaneous combination of crane operations. Centralized system for the hydraulic pressures control.

### TRAVEL CONTROLS

Steering wheel for the control of the front steering axle. Electric switch for independent steering of the rear wheels.

Manual gearshift and parking brake. Electric switch for the control of the low and high range speeds with automatic engagement of the 2 or 4 wheel drive. Engine alarm instrumentation.

### LOAD MOMENT INDICATOR

LMI with 8" touchscreen colours display with customizable graphics. Anti-two-block system with acoustic and visual alarm and locking of the crane movements. Boom angle and extension recognition system. Pressure transducers on the hoisting cylinder. Automatic detection of the outrigger configuration.

### SAFETY DEVICES

Hook descending limit device. Motion cut device. Hold valves on all cylinders. Pressure relief valves on all hydraulic circuits.

## PARTIE TOURNANTE

### TOURELLE

Construction en acier à haute résistance, entièrement soudée.

### FLECHE

A sections en caisson actionnés hydrauliquement et synchronisés. Système d'extension proportionnel.

### RELEVAGE DE FLECHE

Cylindre hydraulique à double effet avec valve de blocage.

### TREUIL

Hydraulique avec motoréducteur hydraulique à réduction planétaire. Tambour rainuré. Frein multidisques automatique et valve régulatrice.

### ORIENTATION

Moteur hydraulique avec réducteur planétaire à double réduction. Frein multidisques négatif. Dispositif de rotation libre de la tourelle. Orientation continuée à 360°. Broche de verrouillage de la tourelle commandée manuellement depuis la cabine.

### CABINE

Construite en acier et suspendue et montée sur la tourelle sur des amortisseurs sur le coté gauche; grande visibilité avec verres de sécurité avec possibilité d'ouverture des vitres antérieures et postérieures. Deux essuies glaces électriques. Siège coulissant et réglable en hauteur et profondeur selon le poids de l'opérateur. Ceinture de sécurité. Chauffage indépendant.

### COMMANDES DE TRAVAIL GRUE

Manipulateurs hydrauliques montés sur les accoudoirs du siège de l'opérateur pour la commande indépendante ou simultanée des mouvements de la grue. Interrupteurs électriques pour le contrôle des stabilisateurs, de la marche rapide du treuil et de l'orientation libre.

### DISTRIBUTEURS

Distributeurs hydrauliques séparés, assurent la combinaison simultanée des mouvements de la grue. Système centralisé pour le contrôle des pressions hydrauliques.

### COMMANDES DE DEPLACEMENT

Volant pour la direction des roues AV. Interrupteur électrique pour la direction indépendante des roues AR. Boite de vitesse manuelle et frein à main. Interrupteur électrique pour la commande des vitesses lente et rapide avec insertion automatique des 2 ou 4 roues motrices. Instrumentation allarme moteur.

### LIMITEUR DE CHARGE

CEC avec display 8" touchscreen à couleurs avec graphique personnalisable. Système anti-two block avec allarme acoustique et visuelle et blocage des mouvements de la grue. Système de reconnaissance angle et dépliage de la flèche. Transducteur de pression sur vérin de soulèvement. Reconnaissance automatique de la configuration des stabilisateurs.

### DISPOSITIFS DE SECURITE

Limiteurs de fin course du crochet. Clapets anti-retour sur tous les vérins. Limiteurs de pression sur tous les circuits hydrauliques.

o Le specifiche dei prodotti sono soggette a modifiche senza obbligo di preavviso. Le fotografie sono a solo scopo illustrativo.

o Products specifications are subject to change without notice or obligation. Photographs are for illustrative purposes only.

o Les spécifications des produits sont sujets à modification sans avis ou obligation. Les photographies sont uniquement pour illustration.

Courtesy of Crane.Market

# GRIL 55.50 >>



## PORTATE BRACCIO TELESCOPICO - LIFTING CAPACITIES TELESCOPIC BOOM - CAPACITES DE LEVAGE FLECHE TELESCOPIQUE



100%



9,5 - 37,2 m



5 t



360°



m	9,5 m	13,0 m	15,5 m	19,9 m	23,2 m	26,8 m	29,2 m	31,7 m	34,2 m	37,2 m	m
3,0	50,0	42,2	32,6	19,7	19,4						3,0
3,5	41,8	37,3	28,5	20,0	18,3	16,5					3,5
4,0	36,4	33,1	25,8	20,0	17,3	15,5	14,0				4,0
4,5	33,2	30,3	24,1	20,5	16,4	14,8	13,7	10,9			4,5
5,0	27,8	26,7	22,5	20,7	15,5	14,2	13,0	10,6		6,5	5,0
6,0	22,1	21,7	19,9	21,0	14,0	13,0	11,8	9,6	9,3	6,4	6,0
7,0		17,6	17,3	18,3	12,7	11,8	10,8	9,0	8,8	5,9	7,0
8,0		14,3	13,9	15,5	11,6	11,0	10,0	8,4	8,3	5,3	8,0
9,0		11,1	10,8	12,2	10,7	10,2	9,2	7,9	7,7	4,8	9,0
10,0			8,7	9,9	9,9	9,5	8,3	7,4	7,2	4,5	10,0
12,0			5,8	7,2	8,0	7,6	7,2	6,5	6,3	3,8	12,0
14,0				5,3	6,2	5,8	5,3	6,0	5,5	3,2	14,0
16,0				4,0	5,0	4,5	4,0	4,6	4,2	2,9	16,0
18,0					3,9	3,6	3,1	3,7	3,3	2,4	18,0
20,0						2,8	2,4	3,0	2,5	2,1	20,0
22,0							2,2	1,8	2,3	1,8	22,0
24,0								1,3	1,8	1,5	24,0
26,0									1,4	1,1	26,0
28,0										0,8	28,0
30,0										0,5	30,0
32,0										0,4	32,0



100%



9,5 - 37,2 m



5 t



360°



m	9,5 m	13,0 m	15,5 m	19,9 m	23,2 m	26,8 m	29,2 m	31,7 m	34,2 m	37,2 m	m
2,5	55,0										2,5
3,0	50,0	42,2	32,6	19,7	19,4						3,0
3,5	41,8	37,3	28,5	20,0	18,3	16,5					3,5
4,0	36,4	33,1	25,8	20,0	17,3	15,5	14,0				4,0
4,5	33,2	30,3	24,1	20,5	16,4	14,8	13,7	10,9			4,5
5,0	27,8	26,7	22,5	20,7	15,5	14,2	13,0	10,6		6,5	5,0
6,0	22,1	21,7	19,9	21,0	14,0	13,0	11,8	9,6	9,3	6,4	6,0
7,0		17,6	17,3	18,3	12,7	11,8	10,8	9,0	8,8	5,9	7,0
8,0		14,8	13,9	15,5	11,6	11,0	10,0	8,4	8,3	5,3	8,0
9,0		12,1	11,4	12,2	10,7	10,2	9,2	7,9	7,7	4,8	9,0
10,0			9,4	10,1	9,9	9,5	8,3	7,4	7,2	4,5	10,0
12,0			6,4	7,5	8,0	7,6	7,2	6,5	6,3	3,8	12,0
14,0				5,8	6,5	6,2	5,8	6,0	5,5	3,2	14,0
16,0				4,4	5,2	4,8	4,4	4,9	4,5	2,9	16,0
18,0					4,2	3,9	3,4	3,7	3,6	2,4	18,0
20,0						3,1	2,7	3,2	2,7	2,1	20,0
22,0							2,5	2,0	2,5	1,8	22,0
24,0								1,5	1,9	1,7	24,0
26,0									1,5	1,2	26,0
28,0										0,8	28,0
30,0										0,5	30,0
32,0										0,4	32,0

o Le specifiche dei prodotti sono soggette a modifiche senza obbligo di preavviso. Le fotografie sono a solo scopo illustrativo.

o Products specifications are subject to change without notice or obligation. Photographs are for illustrative purposes only.

o Les spécifications des produits sont sujets à modification sans avis ou obligation. Les photographies sont uniquement pour illustration.

Courtesy of Crane.Market

## DIAGRAMMA DI LAVORO - WORKING DIAGRAM - DIAGRAMME DE TRAVAIL

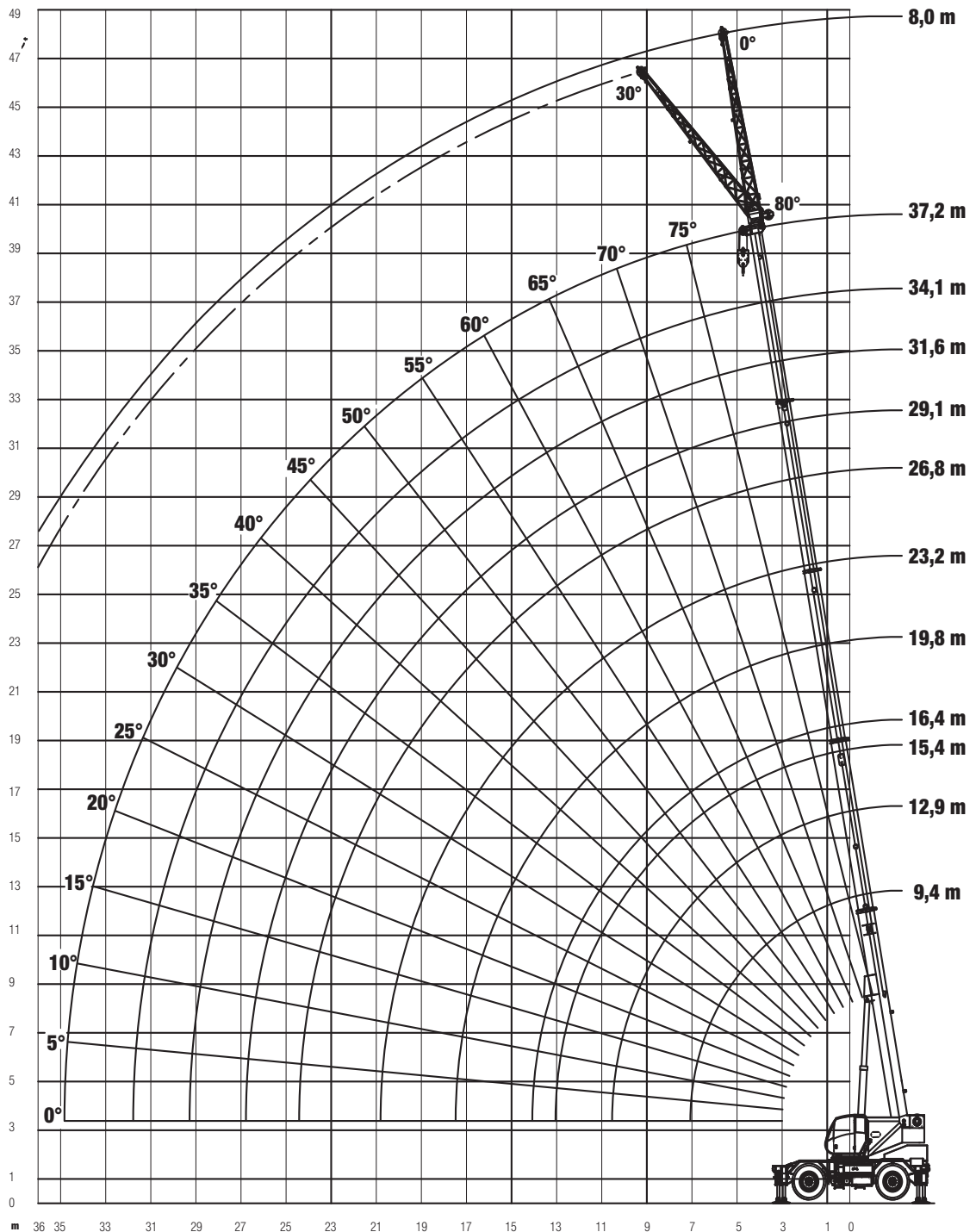
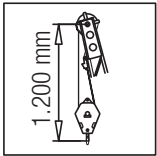
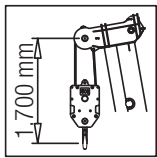

### NOTE SULLA TABELLA DI PORTATE

- Le portate sono indicate in tonnellate (t).
- Il peso dei bozzelli, delle prolunghe e di eventuali accessori deve essere detratto dalle portate indicate in tabella per ottenere il carico netto sollevabile.
- I raggi di lavoro sono misurati dal centro della ralla di rotazione.
- Per ulteriori dettagli consultare il manuale d'uso dell'autogru.

### NOTES TO LOAD CHARTS

- Lifting capacities are given in tonnes (t).
- The weight of the hookblocks, of the extensions and of any accessory must be deducted from the rate indicated in the charts to get the net lifting load.
- Working radius is measured from the center of the slewing ring.
- For further details refer to the operator's manual of the crane.

### NOTES AU TABLEAU DE CHARGE

- Les capacités de levage sont données en tonnes (t).
- Le poids des moufles, des extensions et de tout accessoire doit être déduit de la valeur indiquée dans le tableau pour obtenir la charge de levage net.
- Rayon de travail sont mesurés à partir du centre de la couronne d'orientation.
- Pour plus de détails consulter le manuel de l'opérateur de la grue.

## PORTATE SU GOMMA - LIFTING CAPACITIES ON TYRES - CAPACITES SUR PNEUS



m	0 km/h			3 km/h			m
	360°			0°			
	9,50 m	16,4 m	23,2 m	9,50 m	16,4 m	23,2 m	
3,0	11,6			16,0			3,0
3,5	9,9			14,6	13,0		3,5
4,0	8,5			13,0	12,0	11,0	4,0
4,5	7,5			11,8	11,0	10,5	4,5
5,0	6,6	7,2		10,7	10,0	10,0	5,0
6,0	5,1	5,8	5,9	8,9	9,0	8,9	6,0
7,0		4,5	4,7		7,6	7,5	7,0
8,0		3,7	3,9		6,4	6,4	8,0
9,0		2,9	3,2		5,5	5,5	9,0
10,0		2,3	2,6		4,5	4,6	10,0
12,0		1,3	1,7		3,4	3,5	12,0
13,0			1,4			3,1	13,0
14,0			1,0			2,7	14,0
15,0			0,8			2,4	15,0
16,0			0,5			2,1	16,0
17,0						1,9	17,0
18,0						1,6	18,0

## PORTATE PROLUNGA - LIFTING CAPACITIES BOOM EXTENSION - CAPACITES DE LEVAGE FLECHETTE



m	9,4 m		26,8 m		27,2 m		m
	8 m		8 m		8 m		
	0°	30°	0°	30°	0°	30°	
2,5	3,1						2,5
3,0	3,0						3,0
3,5	2,9						3,5
4,0	2,8						4,0
4,5	2,7		3,5				4,5
5,0	2,5	1,2	3,4		2,6		5,0
6,0	2,3	1,1	3,3		2,6		6,0
7,0	2,1	1,0	3,1		2,6		7,0
8,0	1,7	1,0	3,0	1,2	2,6		8,0
9,0	1,4	0,9	3,0	1,2	2,5		9,0
10,0	1,2	0,9	2,9	1,1	2,2	1,2	10,0
12,0	0,7	0,8	2,5	1,0	1,9	1,2	12,0
14,0			2,3	1,0	1,7	1,1	14,0
16,0			2,1	1,0	1,4	1,0	16,0
18,0			1,7	0,9	1,2	1,0	18,0
20,0			1,4	0,8	1,0	1,0	20,0
22,0			1,2	0,8	0,8	0,9	22,0
24,0			0,9	0,8	0,7	0,9	24,0
26,0			0,7	0,6	0,5	0,8	26,0
28,0					0,4	0,8	28,0
30,0						0,8	30,0
32,0						0,6	32,0

### DATI TECNICI - SPECIFICATIONS - CARACTERISTIQUES

	Lunghezza braccio Boom length Longeur flèche	Altezza massima Maximum height Hauteur maximale	Sezioni Sections Segments	Angolo di inclinazione Luffing angle Plage de relevage	Sollevamento / abbassamento Raising / lowering Relevage / abaissement	Estensione / retrazione Extension / retraction Extension / retraction			
	9,4m - 37,2m	40,0m	5	0° / +80°	62s / 90s	74s / 59s			
	Portata totale Total flow rate Flux totale		Serbatoio Tank capacity Capacite reservoir		Rotazione torretta 360° Upperstructure slewing 360° Rotation tourelle 360°				
	380L/min		545L		18s				
		Velocità Speed Vitesse	Diametro fune Rope diameter Diametre cable	Lunghezza fune Rope length Longeur cable	Tiro massimo Line pull Traction du cable	Configurazione Configuration Configuration			
		110 m/min	16 mm	175 m	49,1 kN	Standard			
		62 m/min	15 mm	120 m	39,2 kN	Optional			
	Portata CE Capacity CE Capacite CE	Portata 85% Capacity 85% Capacite 85%	Carrucole Sheaves Poulies	Taglie Lines Brins	Peso Weight Poids	Configurazione Configuration Configuration			
	50 t	55 t	5	11	570kg	Standard			
	15 t	15 t	1	3	290 kg	Optional			
	5 t	5 t	0	1	100 kg	Optional			
	Peso totale Totale Weight Poids total		Peso assale anteriore Weight on frontal axle Poids sur essieu avant		Peso assale posteriore Weight on rear axle Poids sur essieu arriere				
	33,1 t		15,7 t		17,4 t				
	Motore Engine Moteur	Modello Model Model	Cilindri Cylinders Cylindres	Potenza nominale Rated power Puissance nominale	Coppia massima Max torque Couple maximale	Serbatoio Tank capacity Capacite reservoir			
	CUMMINS	QSB 6.7	6	119kW@2200rpm(Tier IIIA) 118kW@2200rpm(Tier IVF)	732 Nm@1500rpm(Tier IIIA) 841 Nm@1500rpm(Tier IVF)	200L			
		<b>F1</b>	<b>F2</b>	<b>F3</b>	<b>R1</b>	<b>R2</b>	<b>R3</b>		
	4x4	3,6 km/h	7,9 km/h	18,4 km/h	3,6 km/h	7,9 km/h	18,4 km/h	16.00 x 25	70%
	4x2	7,2 km/h	15,6 km/h	36,4 km/h	7,2 km/h	15,6 km/h	36,4 km/h	16.00 x 25	17%
	Accessori sollevamento Lifting options Accessoires de levage			Accessori confort e speciali Confort and special options Accessoires confort et speciales					
	Naso	Heavy duty jib	Runner	Condizionatore	Air conditioning	Climatisation			
	Prolunga singola	Single jib	Flechette	Kit alte temperature	High temperatures kit	Kit hautes temperatures			
	Prolunga doppia	Double jib	Flechette double	Tropicalizzazione	Tropicalization	Tropicalisation			
	Argano ausiliario	Auxiliary hoist	Treuil auxiliaire	Kit climi freddi	Cold climate kit	Kit climat froid			
	Ganci compatti	Compact hooks	Crochets compacts	Ruota di scorta	Spare wheel	Roue de secours			
	Fari di lavoro	Working lights	Phares de travail	Kit raffineria	Refinery kit	Kit raffinerie			

### SIMBOLI - SYMBOLS - SYMBOLES

	Braccio telescopico Telescopic boom Flèche télescopique		Raggio Radius Portée		Argano ausiliario Auxiliary hoist Treuil auxiliaire		Marcia Gear Rapport
	Sfilo braccio Boom telescoping Télescopage de flèche		Contrappeso Counterweight Contrepoids		Prolunga braccio Boom extension Rallonge de flèche		Gamma lenta Low range Gamme basse
	Elevazione braccio Boom elevation Relevage de flèche		Bozzello Hookblock Crochet moufle		Stabilizzatori Outriggers Calage		Gamma veloce High range Gamme haute
	Rotazione Slewing Orientation		Argano principale Main hoist Treuil principal		Pneumatici Tyres Pneumatiques		Motore Engine Moteur

o Le specifiche dei prodotti sono soggette a modifiche senza obbligo di preavviso. Le fotografie sono a solo scopo illustrativo.

o Products specifications are subject to change without notice or obligation. Photographs are for illustrative purposes only.

o Les spécifications des produits sont sujets à modification sans avis ou obligation. Les photographies sont uniquement pour illustration.

Courtesy of Crane.Market

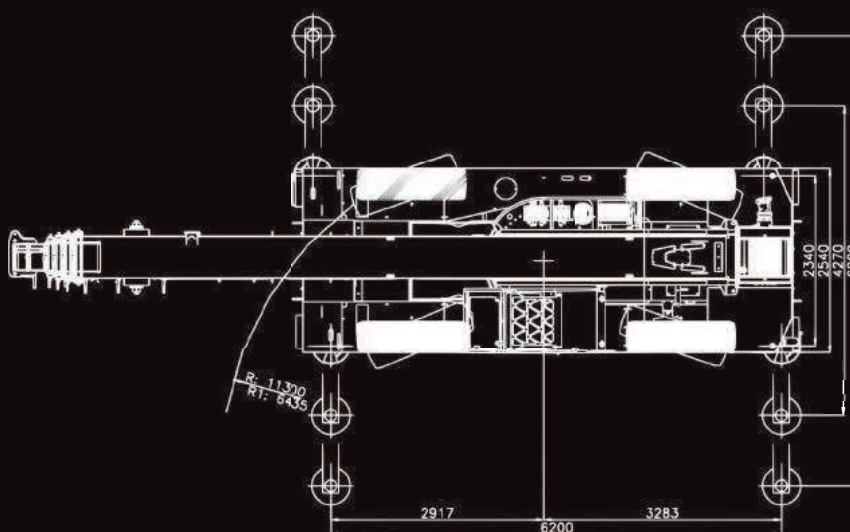
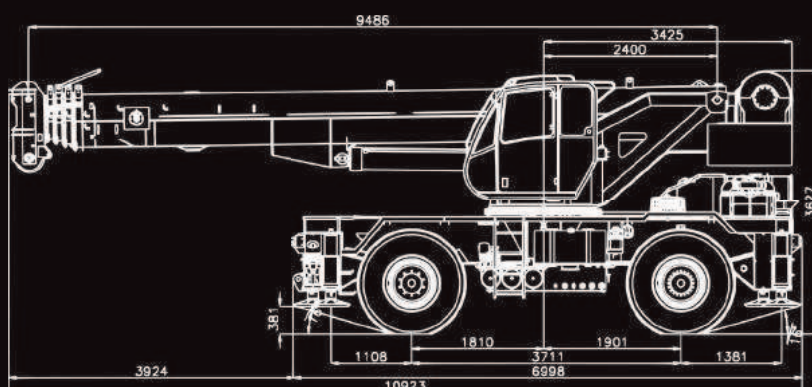
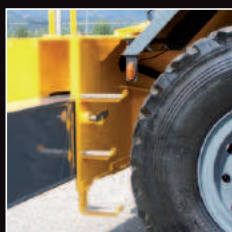
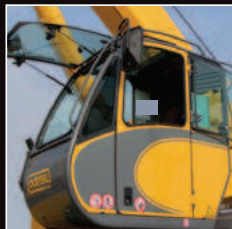

» [www.locatell Crane.com](http://www.locatell Crane.com)

LOCATELLI CRANE srl

Via Lombardia n. 32 - 24030 Mapello (BG) - Italy - Tel. +39 035 4945066 - Fax +39 035 4945549 - info@locatell Crane.com