

**Manitex**



# TC400

**40-ton (36,3 mt) TELESCOPIC CRANE**  
**TC400 SERIES PRODUCT GUIDE**



















# CONTENTS

















Crane Features .....	4
TC400 Chassis Data - S Models .....	5
TC400 Chassis Data - SHL Models .....	6
Outrigger Extension.....	7
Sub Frame .....	7
Electrical System .....	7
4077S Load Chart: Main Boom .....	8
4077S Boom Diagram .....	9
4077SHL Load Chart: Main Boom.....	10
4077SHL Boom Diagram .....	11
40100S Load Chart: Main Boom and Jib .....	12
40100S Boom Diagram .....	13
40100SHL Load Chart: Main Boom and Jib.....	14
40100 SHL Boom Diagram .....	15
40124S Load Chart: Main Boom and Jib .....	16
40124S Boom Diagram .....	17
40124SHL Load Chart: Main Boom and Jib.....	18
40124SHL Boom Diagram .....	19
Area of Operation .....	20
Reeving Diagram.....	20
LMI Codes .....	21
Warning, Information & Definitions .....	21
Technical Descriptions .....	22-23
Options .....	23

Effective Date: September 1, 2013  
 This document is non-contractual. This document is supplied for reference use only. We are constantly making improvements to our products and reserve the right that specification, equipment, and prices are all subject to change without notice or obligation.  
 The photographs, and /or images in this document are for illustrative purposes only and may include optional equipment and accessories and may not include all standard equipment.  
 Refer to the appropriate Operator's Manual and Load Charts for instructions on the proper use of this equipment to determine allowable crane lifting capacities, assembly and operating procedures.  
 Failure to follow the appropriate operator's manual or load chart(s) when using our equipment or to otherwise act irresponsibly may result in serious injury or death.  
 The only warranty applicable to our equipment is the standard written warranty applicable to the particular product and sale. Manitex makes no other warranty, expressed or implied.  
 Products and services listed may be trademarks, service marks or trade-names of Manitex International and /or its subsidiaries in the USA and other countries.  
 All rights are reserved. Manitex® is a registered trademark of Manitex International, Inc. in the USA and many other countries.  
 Copyright 2013 Manitex Inc. Manitex Inc, Georgetown Texas, 78626



# KEY

	Operator aids
	Cab
	Heating / Air conditioning
	Controls
	Hoist speed
	1 - Main hoist 2 - Auxiliary winch 3 - Recovery winch
	Rope length
	Rope - standard/optional
	Rope diameter
	Permissible line pull
	Maximum line pull
	Slewing / Allowable slewing range
	Slewing gears
	Slewing brake
	Outriggers / Lifting on outriggers
	2-Person man basket
	Counterweight
	Radio remote control

	Hook block
	Distance from hook to head sheave pin
	Hook and ball
	Hydraulics
	Boom elevation angle
	Max. boom length with extension
	Boom with extension retracted
	Boom angle
	Telescoping mode
	Working radius
	Boom length
	Hydraulic actuated boom
	Full power mechanical synchronized
	Boom head / Hook block dimension
	Main boom with auxiliary head
	Tip height



## THE TC400 SERIES TELESCOPIC CRANES

### Versatile. Affordable. User friendly.

The TC400 series telescopic cranes are built to meet the wide-ranging needs of owner operators who may use it for residential construction one day and bridge work the next. No matter what the task, the 40-ton line of telescopic crane is designed to get you to the job and on the job quickly.

With it, you can:

- Travel to and between job sites at highway speed on a commercial chassis
- Set up quickly with radio outrigger controls
- Operate comfortably and confidently in its tiltable cab

### Other features include:

- 40-ton capacity @ 5 ft. radius
- 3, 4 & 5-section proportional boom
- Optional telescopic jib
- 187 ft. maximum tip height (with optional telescopic jib)
- Tiltable cab
- Out-and-down outriggers
- Remote outrigger controls

### RADIO OUTRIGGER CONTROLS

Operate the outriggers remotely, with a clear view of the machine, using radio outrigger controls we call ROC Solid.

### TWO-SPEED PLANETARY HOIST

Increase productivity and minimize downtime. The two-speed planetary hoist lets you change line speed on the fly and minimize rope stacking.

### REMOTE WINCH CONTROL

Lower and raise the hook block quickly. With remote winch control on the TC400 series, the winch can be operated from any location. (OPTIONAL)



Operator cab tilts from 0° to 20° for a comfortable, clear view of the load.

### INCREASE PROFITABILITY

The versatile TC400 series is designed to help both owners and operators make the most of their investment.

- Travel to and between jobs at highway speed.
- Minimize maintenance costs with replaceable, self-lubricating boom slider pads and sealed, multi-disc wet brakes on the hoist and swing system.
- Minimize repair costs with its front stabilizer and first-up auto retract feature that prevents drive-away damage.



# TC400 SERIES CHASSIS DATA: S MODELS

## TC400 Series S Dimensions

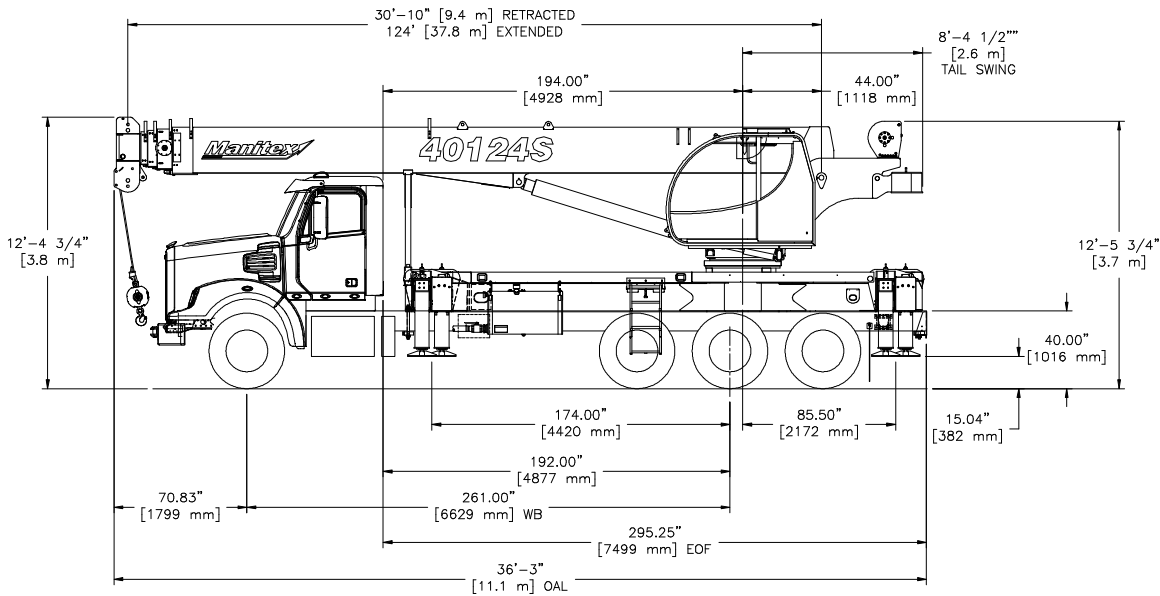

## Auxiliary Winch

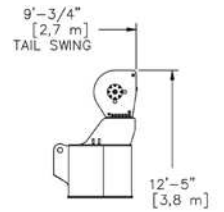

## Auxiliary Sheave Head

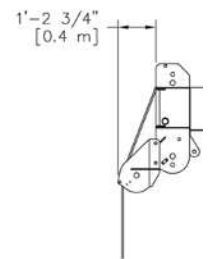

## CHASSIS DATA

S Models	
Wheel Base (WB)	261 in. (6,639 mm)
Cab to Tandem (CT)	192 in. (4,877 mm)
Cab to End of Frame (EOF)	295 in. (7,493 mm)
Nominal frame W	34 in. (864 mm)
Frame section modulus at 180/360° area of operation*	25.0 in <sup>3</sup> , 110,000 psi, 758,422 kPa

\* Frame selection modulus at 360° area of operation requires front bumper stabilizer.

## TRUCK AXLE WEIGHTS

Model	4077S	40100S	40124S
Front axle (GW)	18,000 lbs. (8,165 kg)	18,000 lbs. (8,165 kg)	20,000 lbs. (9,072 kg)
Rear axle	40,000 lbs. (18,144 kg)	40,000 lbs. (18,144 kg)	40,000 lbs. (18,144 kg)
Min. truck axle W - Front**	8,000 lbs. (3,629 kg)	8,000 lbs. (3,629 kg)	9,200 lbs. (4,173 kg)
Min. truck axle W - Rear**	8,300 lbs. (3,765 kg)	8,300 lbs. (3,765 kg)	8,300 lbs. (3,765 kg)

\*\* Minimum chassis weight is required to meet 85% stability requirements. Chassis data is general - not for engineering. Some dimensions depend on truck selection.

## CRANE WEIGHTS

Model	4077S	40100S	40124S
Crane	28,895 lbs. (13,107 kg)	30,965 lbs. (14,045 kg)	32,385 lbs. (14,690 kg)
Jib fixed	830 lbs. (376 kg)	830 lbs. (376 kg)	830 lbs. (376 kg)
Jib telescopic	1,720 lbs. (780 kg)	1,720 lbs. (780 kg)	1,720 lbs. (780 kg)
Flatbed 8 ft.	825 lbs. (374 kg)	825 lbs. (374 kg)	825 lbs. (374 kg)
Flatbed 10 ft.	1,000 lbs. (454 kg)	1,000 lbs. (454 kg)	1,000 lbs. (454 kg)

Notes: Additional axles required for federal bridge legal configuration - consult Manitex. Manitex highly recommends the addition of a front stabilizer and it may be required on some installations - consult Manitex.

Data published herein is intended as a guide only. Crane operation is subject to machine specific load charts and information.



# TC400 SERIES CHASSIS DATA: SHL MODELS

## TC400 Series SHL Dimensions

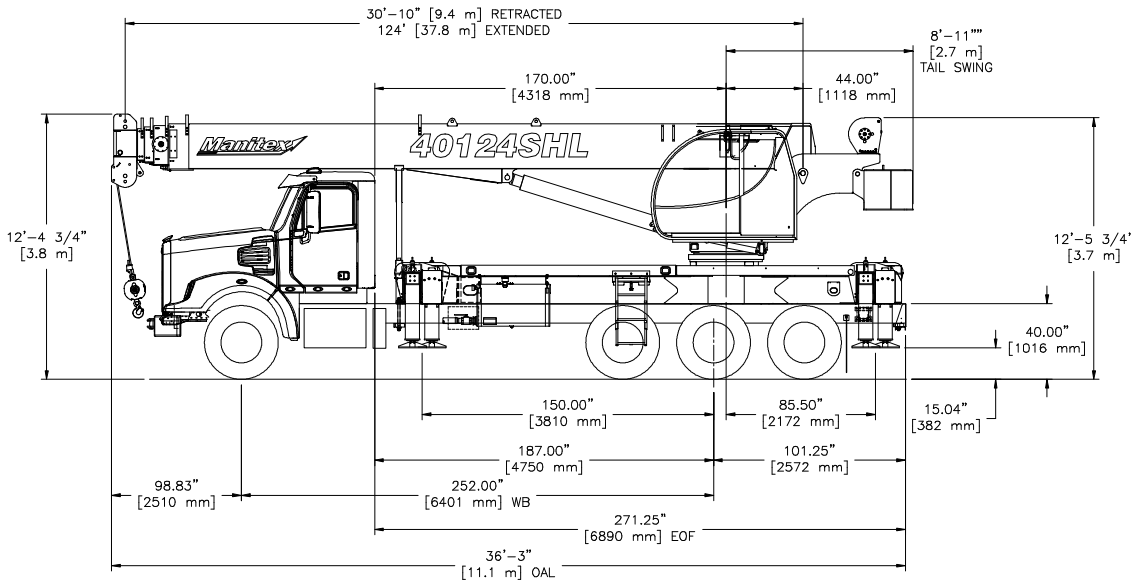

## Auxiliary Winch

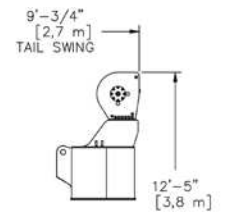

## Auxiliary Sheave Head

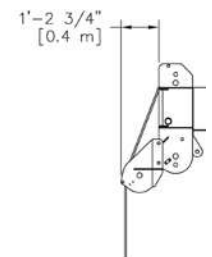

## CHASSIS DATA

SHL Models	
Wheel Base (WB)	252 in. (6,401 mm)
Cab to Tandem (CT)	187 in. (4,750 mm)
Cab to End of Frame (EOF)	271 in. (6,883 mm)
Nominal frame length	34 in. (864 mm)
Frame section modulus at 180/360° area of operation*	25.0 in <sup>3</sup> , 110,000 psi 758,422 kPa

\* Frame selection modulus at 360° area of operation requires front bumper stabilizer.

## TRUCK AXLE WEIGHT

Model	4077SHL	40100SHL	40124SHL
Front axle (GW)	20,000 lbs. (9,072 kg)	20,000 lbs. (9,072 kg)	20,000 lbs. (9,072 kg)
Rear axle	44,000 lbs. (19,958 kg)	44,000 lbs. (19,958 kg)	44,000 lbs. (19,958 kg)
Min. truck axle weight - Front**	9,800 lbs. (4,445 kg)	9,800 lbs. (4,445 kg)	9,800 lbs. (4,445 kg)
Min. truck axle weight - Rear**	8,000 lbs. (3,629 kg)	8,000 lbs. (3,629 kg)	8,000 lbs. (3,629 kg)

\*\* Minimum chassis weight is required to meet 85% stability requirements. Chassis data is general - not for engineering. Some dimensions depend on truck selection.

## CRANE WEIGHTS

Model	4077SHL	40100SHL	40124SHL
Crane	34,995 lbs. (15,873 kg)	37,065 lbs. (16,812 kg)	38,485 lbs. (17,457 kg)
Jib fixed	830 lbs. (376 kg)	830 lbs. (376 kg)	830 lbs. (376 kg)
Jib telescopic	1,720 lbs. (780 kg)	1,720 lbs. (780 kg)	1,720 lbs. (780 kg)
Flatbed 8 ft.	825 lbs. (374 kg)	825 lbs. (374 kg)	825 lbs. (374 kg)
Flatbed 10 ft.	1,000 lbs. (454 kg)	1,000 lbs. (454 kg)	1,000 lbs. (454 kg)

Notes: Additional axles required for federal bridge legal configuration - consult Manitex. Manitex highly recommends the addition of a front stabilizer and it may be required on some installations - consult Manitex.

Data published herein is intended as a guide only. Crane operation is subject to machine specific load charts and information.

# OUTRIGGER EXTENSION

## Full Extension

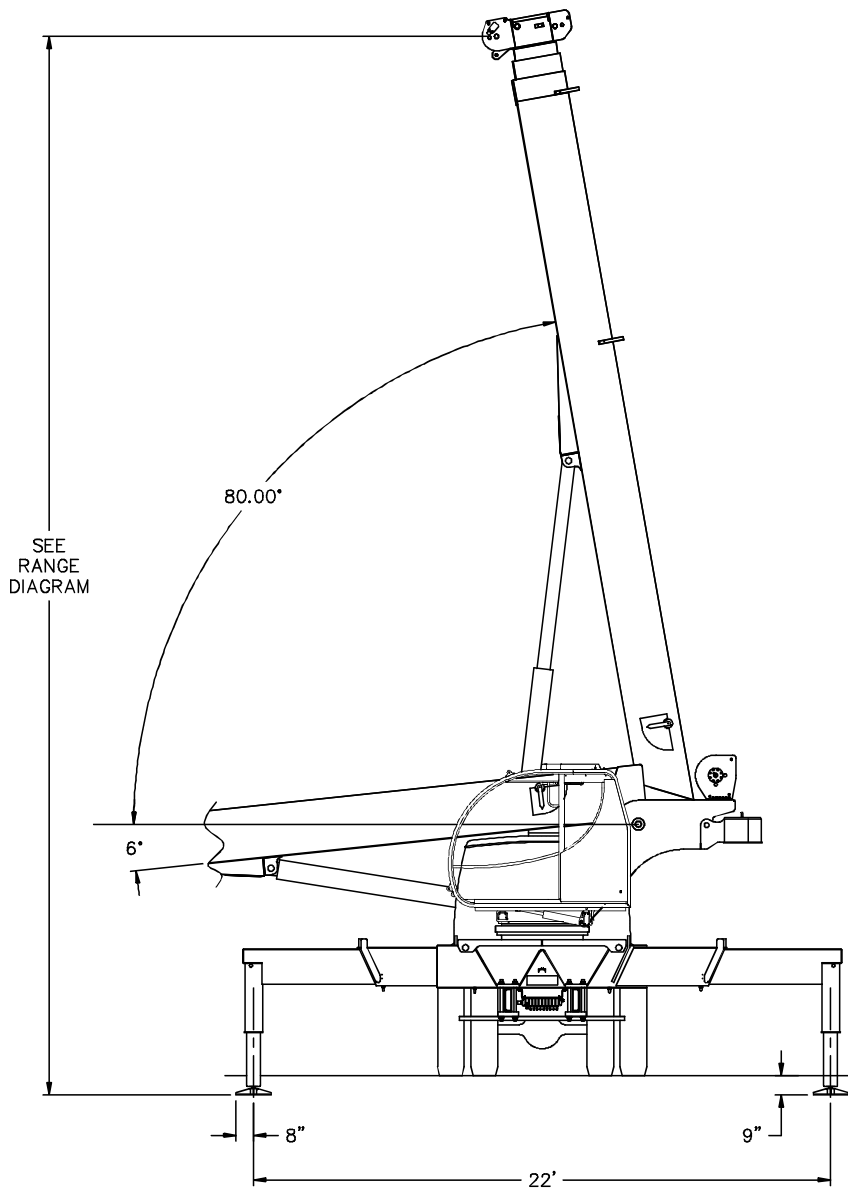

## Middle Extension

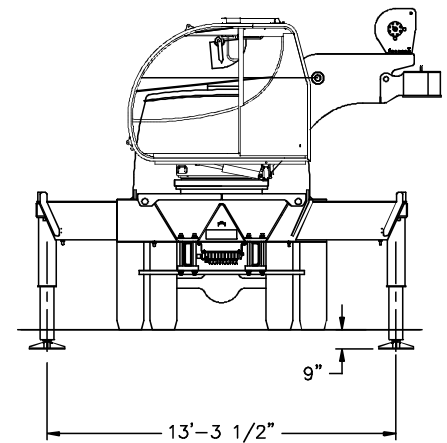

## Full Retraction

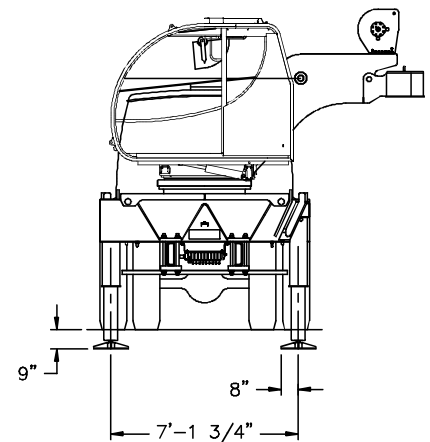

## SUB FRAME

- Pedestal sub-frame and stabilizers are mounted to chassis by threaded rods and clamp plates
- Sub-frame: Torsion resistant, rigid 4-plate design mounted under crane full length of truck frame
- Rear under-ride protection: Standard on factory mounted cranes

## ELECTRICAL SYSTEM

- State-of-the-art, weather-resistant components throughout
- Hermetically sealed enclosure includes power in relays and circuit status LEDs







Data published herein is intended as a guide only. Crane operation is subject to machine specific load charts and information.

# 4077S LOAD CHART: Main Boom

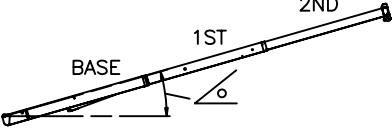
Lifting Capacities 3-section Boom 30.5 ft. - 76.8 ft.  
Full Outrigger Extension

 22 ft. (100%)

 360° Continuous

MAIN BOOM LOAD RATINGS IN LBS. WITH OUTRIGGERS PLACED AS SHOWN AND THE CRANE LEVEL										
LMI CODE #1										
 (ft.)	Loaded Boom Angle (deg)	Boom Length and Marker (lbs.)								
			A		B		C		D	
		30.5 ft.		40 ft.		52 ft.		64 ft.		76.8 ft.
5	75	80,000								
8	69	61,760	74	55,500	79	47,500				
10	65	53,930	71	50,920	76	47,500	80	38,000		
12	61	48,090	68	45,240	74	42,760	78	35,050	80	28,410
15	54	41,110	64	38,890	71	36,570	75	30,890	78	25,500
20	41	31,330	55	31,330	65	29,590	70	25,850	74	21,670
25	21	22,670	46	23,080	58	23,320	65	21,930	70	18,870
30			34	17,220	51	17,460	60	17,580	66	16,470
35			16	13,420	44	13,690	55	13,810	62	13,890
40					34	10,950	49	11,100	58	11,190
45					22	8,790	42	8,960	53	9,050
50							35	7,360	48	7,450
55							25	6,110	43	6,210
60							7	5,090	36	5,230
65									29	4,420
70									19	3,740

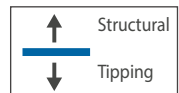

**NOTES:**

- All loads rated at 360° pick
- Loads based on crane on outriggers
- All "on outriggers" loads are based on 85% tipping
- Loads above heavy line are based on structural rating
- Loads below heavy line are based on tipping rating

Data published herein is intended as a guide only. Crane operation is subject to machine specific load charts and information.





# 4077S BOOM DIAGRAM

## - FULLY EXTENDED OUTRIGGER CONFIGURATION -

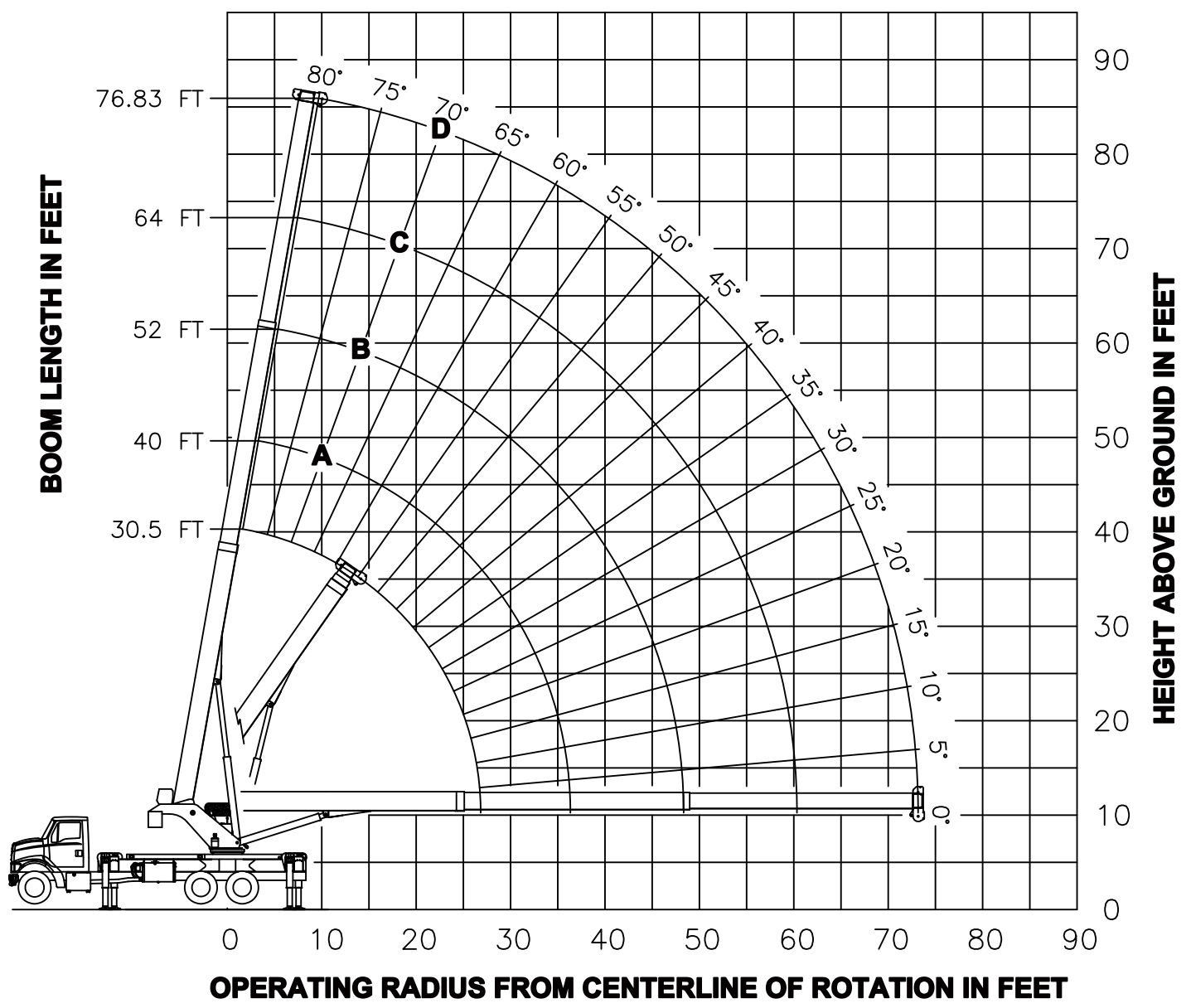

Data published herein is intended as a guide only. Crane operation is subject to machine specific load charts and information.

# 4077SHL LOAD CHART: Main Boom





Lifting Capacities 3-section Boom 30.5 ft. - 76.8 ft.  
Full Outrigger Extension

 22 ft. (100%)

 360° Continuous

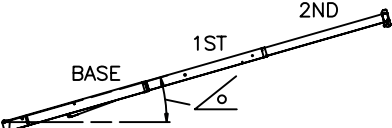
**MAIN BOOM LOAD RATINGS IN LBS. WITH OUTRIGGERS PLACED AS SHOWN AND THE CRANE LEVEL**

LMI CODE #4

 (ft.)	Loaded Boom Angle (deg)	Boom Length and Marker (lbs.)								
			A		B		C		D	
				30.5 ft.		40 ft.		52 ft.		64 ft.
5	75	80,000								
8	69	61,760	74	55,500	79	47,500				
10	65	53,930	71	50,920	76	47,500	80	38,000		
12	61	48,090	68	45,240	74	42,760	78	35,050	80	28,410
15	54	41,110	64	38,890	71	36,570	75	30,890	78	25,500
20	41	33,020	55	31,330	65	29,590	70	25,850	74	21,670
25	21	25,700	46	26,330	58	24,750	65	21,930	70	18,870
30			34	20,490	51	20,730	60	19,000	66	16,470
35			16	16,100	44	16,380	55	16,500	62	14,540
40					34	13,340	49	13,470	58	12,950
45					22	11,090	42	11,230	53	11,300
50							35	9,510	48	9,590
55							25	8,140	43	8,230
60							7	7,000	36	7,120
65									29	6,200
70									19	5,420

↑ Structural  
↓ Tipping

**NOTES:**

- All loads rated at 360° pick
- Loads based on crane on outriggers
- All "on outriggers" loads are based on 85% tipping
- Loads above heavy line are based on structural rating
- Loads below heavy line are based on tipping rating

Data published herein is intended as a guide only. Crane operation is subject to machine specific load charts and information.



# 4077SHL BOOM DIAGRAM

## - FULLY EXTENDED OUTRIGGER CONFIGURATION -

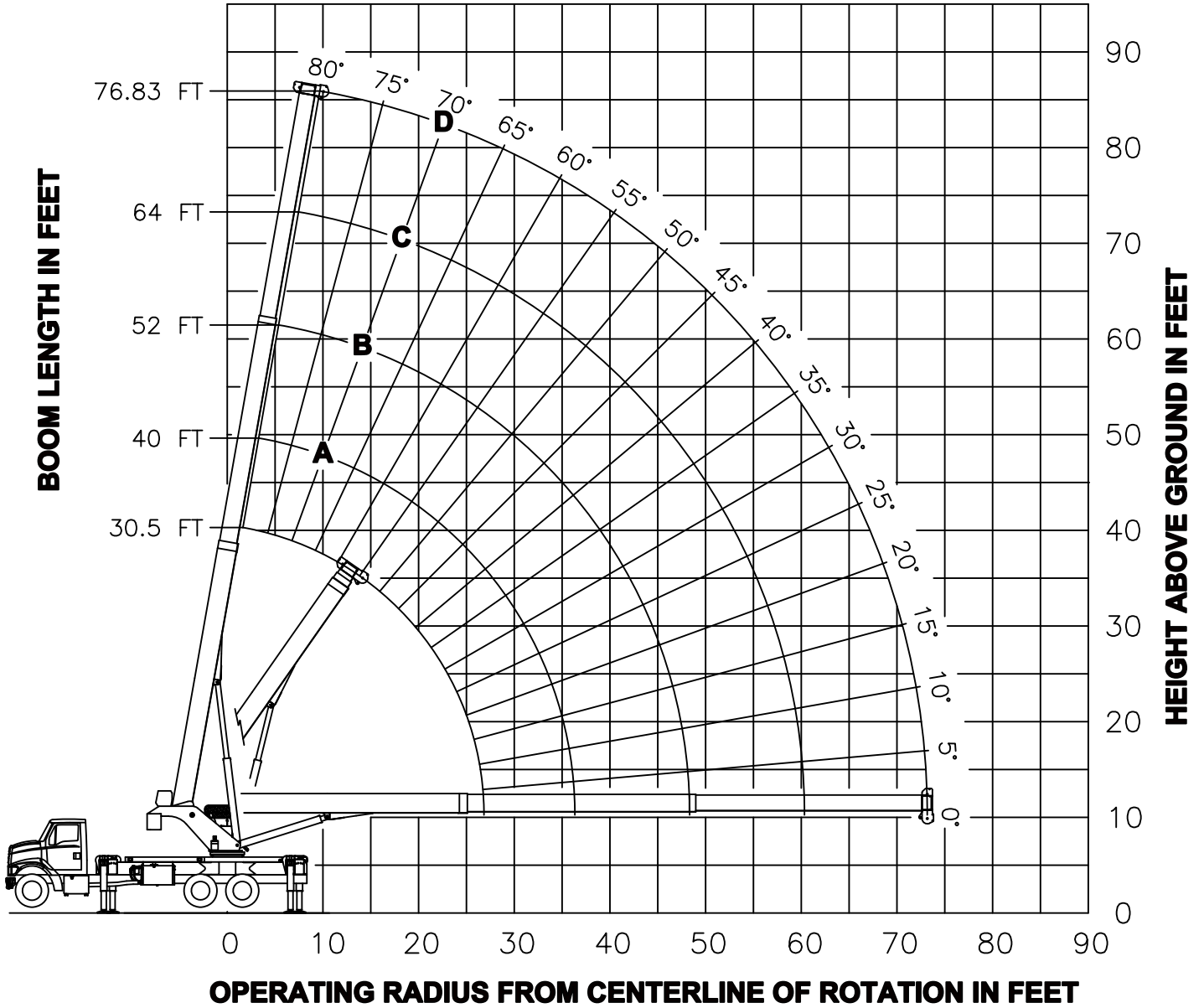

Data published herein is intended as a guide only. Crane operation is subject to machine specific load charts and information.

# 40100S LOAD CHART: Main Boom and Jib

Lifting Capacities 4-section Boom 30.5 ft. - 100 ft.  
1 or 2-section Jib 31 ft. - 55 ft. - Full Outrigger Extension



Load Ratings in (lbs.) with Outriggers and Stabilizers Extended										Jib Load Ratings in (lbs.) with Outriggers and Stabilizers Extended							
LMI Code #1										LMI Code #32							
Loaded Boom Angle (ft.)	Boom length & Marker									Loaded Boom Angle (ft.)	Fixed Jib		Telescopic Jib				
		A (lbs.)		B (lbs.)		C (lbs.)		D (lbs.)			LMI Code #7	LMI Code #13					
	30.5 ft.	52 ft.	68 ft.	84 ft.	100 ft.					See Warning Note: 4	See Warning Note: 4	See Warning Note: 4	See Warning Note: 4				
5	74	80,000															
8	68	61,000															
10	64	52,860	76	31,500													
12	60	47,000	73	31,500	78	31,500											
15	53	40,280	70	31,500	76	31,500	79	23,700									
20	40	30,660	64	28,680	71	26,820	76	20,600	79	14,000							
25	20	22,380	58	23,230	67	22,160	72	18,300	76	13,500							
30			51	17,230	62	17,450	69	15,870	73	12,820	77	7,300	77	7,000			
35			43	13,370	57	13,590	65	13,720	70	11,380	75	7,100	75	6,800	78	4,000	
40			34	10,660	52	10,910	61	11,030	67	10,160	40	73	6,620	73	6,240	76	3,850
45			22	8,440	46	8,710	57	8,850	64	8,940	45	71	6,060	71	5,670	74	3,700
50					39	7,060	52	7,200	60	7,290	50	69	5,550	69	5,150	73	3,550
55					32	5,790	48	5,930	57	6,010	55	66	5,100	66	4,690	71	3,310
60					22	4,760	43	4,910	53	4,990	60	64	4,680	64	4,210	69	3,090
65							37	4,080	49	4,160	65	61	4,210	61	3,740	67	2,900
70							31	3,390	45	3,470	70	59	3,800	59	3,330	65	2,710
75							22	2,800	40	2,890	75	56	3,200	56	2,800	63	2,550
80							7	2,280	35	2,390	80	53	2,690	53	2,290	61	2,400
85									30	1,960	85	50	2,250	50	1,850	59	2,270
90									22	1,580	90	47	1,870	47	1,460	56	2,080
95									11	1,230	95	43	1,530	43	1,120	54	1,820
100											100	40	1,230	40	820	52	1,510
105											105	36	960	36	550	49	1,240
110											110					46	990
115											115					43	770
120											120					40	560
	590 lbs.	350 lbs.	270 lbs.	220 lbs.	180 lbs.	Fixed Jib		Deductions for Stowed Jib									
	890 lbs.	530 lbs.	400 lbs.	330 lbs.	280 lbs.	Telescopic Jib											

**NOTES:**

- All loads rated at 360° pick
- Loads based on crane on outriggers
- All "on outriggers" loads are based on 85% tipping
- Loads above heavy line are based on structural rating
- Loads below heavy line are based on tipping rating

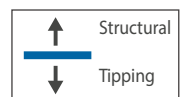

Data published herein is intended as a guide only. Crane operation is subject to machine specific load charts and information.



# 40100S BOOM DIAGRAM

## - FULLY EXTENDED OUTRIGGER CONFIGURATION -

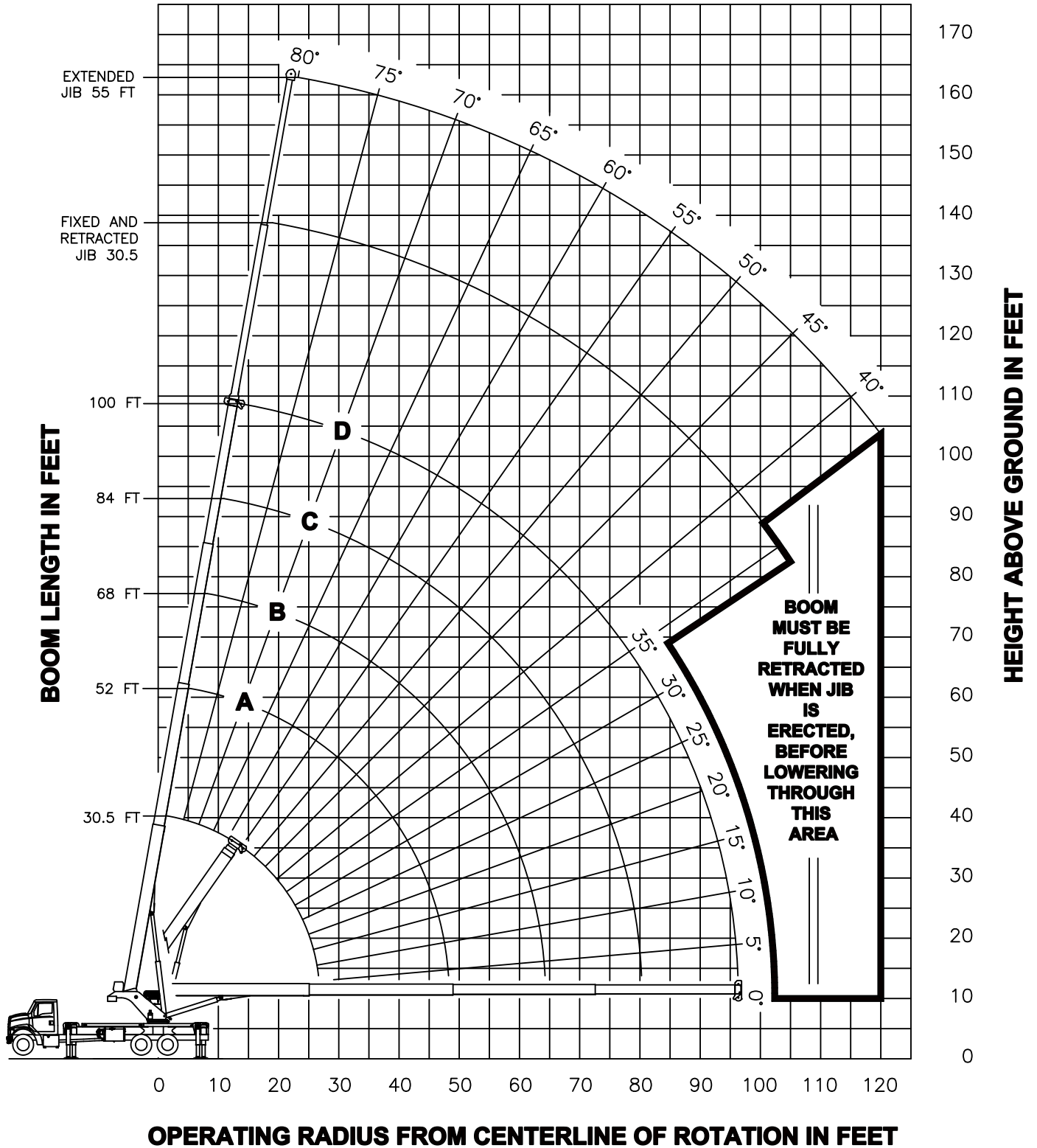

Data published herein is intended as a guide only. Crane operation is subject to machine specific load charts and information.

# 40100SHL LOAD CHART: Main Boom and Jib

Lifting Capacities 4-section Boom 30.5 ft. - 100 ft.  
1 or 2-section Jib 31 ft. - 55 ft. - Full Outrigger Extension

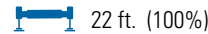

Load Ratings in (lbs.) with Outriggers and Stabilizers Extended										Jib Load Ratings in (lbs.) with Outriggers and Stabilizers Extended						
LMI Code #1										LMI Code #32						
Loaded Boom Angle (ft.)	Boom length & Marker									Loaded Boom Angle (ft.)	Fixed Jib		Telescopic Jib			
		A (lbs.)		B (lbs.)		C (lbs.)		D (lbs.)			LMI Code #7	LMI Code #13				
	30.5 ft.	52 ft.	68 ft.	84 ft.	100 ft.						Jib Length for All Boom Lengths	Jib Length for All Boom Lengths	Jib Length for All Boom Lengths	Jib Length for All Boom Lengths		
5	74	80,000									See Warning Note: 4	See Warning Note: 4	See Warning Note: 4	See Warning Note: 4		
8	68	61,000									30.5 ft.	30.5 ft.	55 ft.			
10	64	52,860	76	31,500						10						
12	60	47,000	73	31,500	78	31,500				12						
15	53	40,280	70	31,500	76	31,500	79	23,700		15						
20	40	31,870	64	28,680	71	26,820	76	20,600	79	14,000						
25	20	24,430	58	23,830	67	22,160	72	18,300	76	13,500						
30			51	20,400	62	19,080	69	15,870	73	12,820	77	7,300	77	7,000		
35			43	15,980	57	16,200	65	13,950	70	11,380	75	7,100	75	6,800		
40			34	12,890	52	13,110	61	12,350	67	10,160	73	6,620	73	6,240		
45			22	10,610	46	10,840	57	10,960	64	9,370	71	6,060	71	5,670		
50					39	9,090	52	9,220	60	8,430	69	5,550	69	5,150		
55					32	7,710	48	7,830	57	7,620	66	5,100	66	4,690		
60					22	6,580	43	6,710	53	6,790	64	4,680	64	4,210		
65							37	5,780	49	5,860	65	4,210	61	3,740		
70							31	5,000	45	5,070	70	3,800	59	3,330		
75							22	4,320	40	4,410	75	3,440	56	2,970		
80							7	3,730	35	3,830	80	3,120	53	2,660		
85									30	3,320	85	2,840	50	2,370		
90									22	2,880	90	2,590	47	2,120		
95									11	2,470	95	2,350	43	1,890		
100											100	2,150	40	1,690		
105											105	1,960	36	1,500		
110											110	1,760	32	1,300		
115											115	1,500	27	1,090		
120											120	1,270	21	850		
125											125	1,040	13	630		
	590 lbs.		350 lbs.		270 lbs.		220 lbs.		180 lbs.		Fixed Jib		Deductions for Stowed Jib			
	890 lbs.		530 lbs.		400 lbs.		330 lbs.		280 lbs.		Telescopic Jib					

**NOTES:**

- All loads rated at 360° pick
- Loads based on crane on outriggers
- All "on outriggers" loads are based on 85% tipping
- Loads above heavy line are based on structural rating
- Loads below heavy line are based on tipping rating

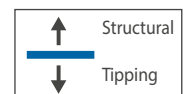

Data published herein is intended as a guide only. Crane operation is subject to machine specific load charts and information.





# 40100SHL BOOM DIAGRAM

## - FULLY EXTENDED OUTRIGGER CONFIGURATION -

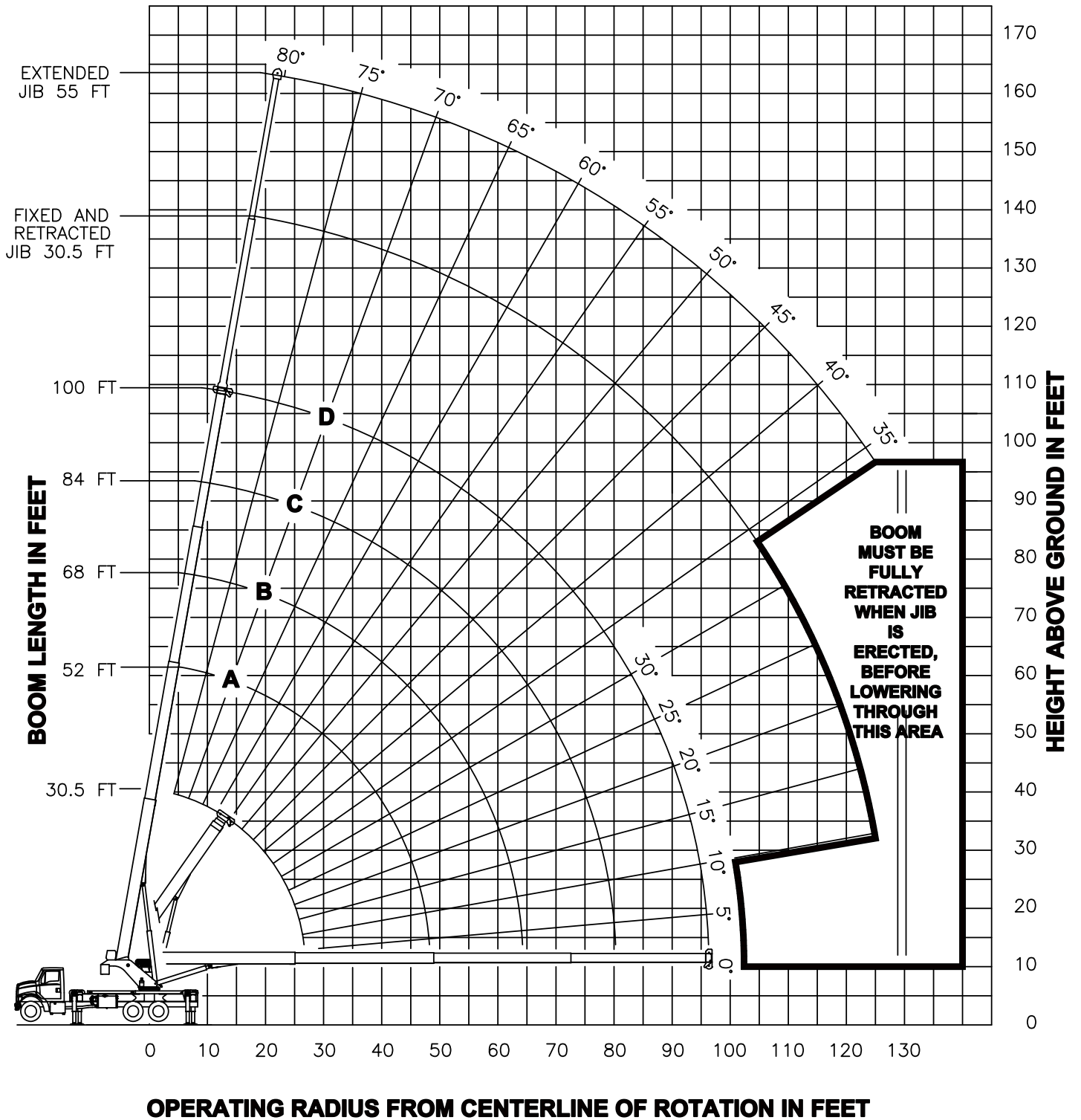

Data published herein is intended as a guide only. Crane operation is subject to machine specific load charts and information.









# 40124S LOAD CHART: Main Boom and Jib

Lifting Capacities 5-section Boom 30.8 ft. - 123.5 ft.

 22 ft. (100%)

 360° Continuous

1 or 2-section Jib 31 ft. - 55 ft. - Full Outrigger Extension

MAIN BOOM LMI CODE 1																		
ft.	30.833 ft.		47 ft. (A)		58 ft. (B)		69 ft. (C)		80 ft. (D)		91 ft. (E)		102 ft. (F)		113 ft. (G)		123.5 ft. (H)	
		Load Capacity (lbs.)		Load Capacity (lbs.)		Load Capacity (lbs.)		Load Capacity (lbs.)		Load Capacity (lbs.)		Load Capacity (lbs.)		Load Capacity (lbs.)		Load Capacity (lbs.)		Load Capacity (lbs.)
5	75	80,000																
8	69	60,500																
10	64	52,500	74	25,000														
12	60	46,600	72	25,000	76	25,000	79	25,000										
15	53	39,600	68	25,000	73	25,000	76	25,000	79	21,500								
20	40	30,300	61	25,000	67	25,000	72	23,900	75	19,700	78	17,100	79	14,500				
25	22	23,070	53	23,760	62	22,840	67	21,650	71	18,200	74	15,850	77	13,500	78	10,910	80	8,450
30			45	18,430	56	18,670	63	18,720	67	16,250	71	14,530	74	12,820	76	10,430	78	8,150
35			36	14,200	49	14,450	58	14,600	63	14,540	68	12,960	71	11,380	73	9,540	75	7,800
40			22	10,880	42	11,190	52	11,370	59	11,490	64	11,570	68	10,160	71	8,680	73	7,280
45					34	8,820	47	9,000	55	9,110	60	9,190	65	9,250	68	8,040	71	6,780
50					23	7,030	40	7,230	50	7,340	56	7,420	61	7,480	65	7,260	68	6,160
55							34	5,850	45	5,970	52	6,050	58	6,110	62	6,150	65	5,540
60							24	4,750	39	4,880	48	4,960	54	5,020	59	5,060	62	5,000
65							6	3,810	33	3,980	43	4,070	51	4,130	56	4,170	59	4,200
70									25	3,230	38	3,330	47	3,390	53	3,430	57	3,460
75									12	2,580	32	2,700	42	2,760	49	2,800	54	2,830
80											25	2,150	37	2,220	45	2,270	51	2,300
85											15	1,670	32	1,750	41	1,800	47	1,840
90													26	1,340	37	1,400	44	1,430
95													17	970	32	1,030	40	1,070
100															26	710	36	750
105																		
110																		
115																		

DEDUCTIONS FROM MAIN BOOM CAPACITIES FOR STOWED JIBS - SFJ = Stowed Fixed Jib, STJ = Stowed Telescopic Jib

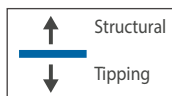

<b>SFJ</b>	450 lbs.	300 lbs	240 lbs.	200 lbs.	180 lbs.	160 lbs.	140 lbs.	130 lbs	120 lbs.
<b>STJ</b>	840 lbs	560 lbs.	450 lbs.	380 lbs.	330 lbs.	290 lbs.	260 lbs.	230 lbs.	210 lbs.





**NOTES:**

- All loads rated at 360° pick
- Loads based on crane on outriggers
- All "on outriggers" loads are based on 85% tipping
- Loads above heavy line are based on structural rating
- Loads below heavy line are based on tipping rating

Data published herein is intended as a guide only. Crane operation is subject to machine specific load charts and information.

JIB LOAD CAPACITIES						
ft.	31 ft. Fixed Jib LMI code #32		30.5 ft. Tele. Jib LMI Code #7		55 ft. Tele. Jib LMI code #13	
		Load Capacity (lbs.)		Load Capacity (lbs.)		Load Capacity (lbs.)
30	80	4,000	79.5	3,300		
35	78	3,850	77.5	3,300	79.5	2,450
40	76	3,700	76	3,300	78	2,450
45	74	3,550	74	3,300	76.5	2,450
50	72	3,400	72	3,300	75	2,450
55	70	3,250	70.5	3,300	73	2,450
60	68	3,080	68.5	3,300	71.5	2,450
65	66	2,910	66.5	3,070	70	2,420
70	64	2,750	64.5	2,750	68	2,260
75	62	2,600	62	2,380	66	2,110

JIB LOAD CAPACITIES						
ft.	31 ft. Fixed Jib LMI code #32		30.5 ft. Tele. Jib LMI Code #7		55 ft. Tele. Jib LMI code #13	
		Load Capacity (lbs.)		Load Capacity (lbs.)		Load Capacity (lbs.)
80	60	2,460	60	2,050	64.5	1,940
85	58	2,260	58	1,660	63	1,750
90	55	1,850	55.5	1,250	61	1,580
95	53	1,490	53	890	59	1,440
100	51	1,170	50.5	570	57	1,260
105	48	880			55	970
110	45	620			53	710
115						
120						
125						

# 40124S BOOM DIAGRAM

## - FULLY EXTENDED OUTRIGGER CONFIGURATION -

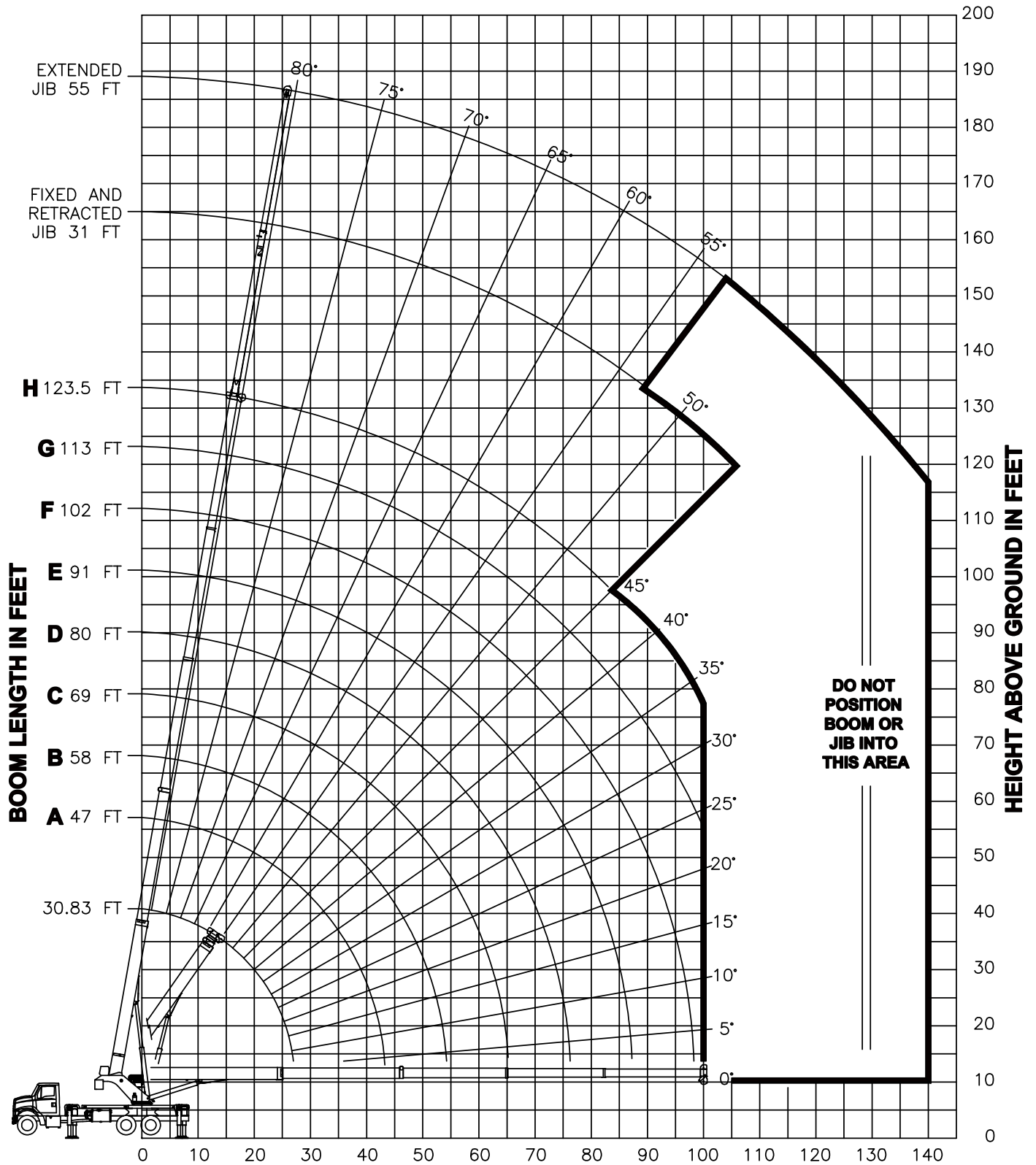











Data published herein is intended as a guide only. Crane operation is subject to machine specific load charts and information.

# 40124SHL LOAD CHART: Main Boom and Jib

Lifting Capacities 5-section Boom 30.8 ft. - 123.5 ft.  
1 or 2-section Jib 31 ft. - 55 ft. - Full Outrigger Extension

 22 ft. (100%)

 360° Continuous

MAIN BOOM LMI CODE 1																		
 (ft.)	30.8 ft.		47 ft. (A)		58 ft. (B)		69 ft. (C)		80 ft. (D)		91 ft. (E)		102 ft. (F)		113 ft. (G)		123.5 ft. (H)	
		Load Capacity (lbs.)		Load Capacity (lbs.)		Load Capacity (lbs.)		Load Capacity (lbs.)		Load Capacity (lbs.)		Load Capacity (lbs.)		Load Capacity (lbs.)		Load Capacity (lbs.)		Load Capacity (lbs.)
5	75	80,000																
8	69	60,500																
10	64	52,500	74	25,000														
12	60	46,600	72	25,000	76	25,000	79	25,000										
15	53	39,600	68	25,000	73	25,000	76	25,000	79	21,500								
20	40	31,330	61	25,000	67	25,000	72	23,900	75	19,700	78	17,100	79	14,500				
25	22	24,100	53	24,010	62	22,840	67	21,650	71	18,200	74	15,850	77	13,500	78	10,910	80	8,450
30			45	20,260	56	19,550	63	18,720	67	16,250	71	14,530	74	12,820	76	10,430	78	8,150
35			36	15,850	49	16,100	58	16,130	63	14,540	68	12,960	71	11,380	73	9,540	75	7,800
40			22	12,630	42	12,900	52	13,060	59	13,070	64	11,610	68	10,160	71	8,680	73	7,280
45					34	10,540	47	10,700	55	10,800	60	10,600	65	9,370	68	8,040	71	6,780
50					23	8,720	40	8,890	50	9,000	56	9,070	61	8,430	65	7,260	68	6,160
55							34	7,460	45	7,570	52	7,640	58	7,620	62	6,550	65	5,540
60							24	6,280	39	6,400	48	6,480	54	6,530	59	5,930	62	5,000
65							6	5,270	33	5,430	43	5,510	51	5,570	56	5,380	59	4,520
70									25	4,610	38	4,700	47	4,760	53	4,790	57	4,090
75									12	3,900	32	4,010	42	4,060	49	4,100	54	3,700
80											25	3,400	37	3,470	45	3,510	51	3,350
85											15	2,860	32	2,940	41	2,990	47	3,020
90													26	2,480	37	2,530	44	2,560
95													17	2,060	32	2,120	40	2,150
100															26	1,750	36	1,790
105															18	1,410	31	1,460
110																	26	1,160
115																	19	880

DEDUCTIONS FROM MAIN BOOM CAPACITIES FOR STOWED JIBS - SFJ = Stowed Fixed Jib, STJ = Stowed Telescopic Jib



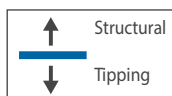

<b>SFJ</b>	450 lbs.	300 lbs	240 lbs.	200 lbs.	180 lbs.	160 lbs.	140 lbs.	130 lbs	120 lbs.
<b>STJ</b>	840 lbs	560 lbs.	450 lbs.	380 lbs.	330 lbs.	290 lbs.	260 lbs.	230 lbs.	210 lbs.







**NOTES:**

- All loads rated at 360° pick
- Loads based on crane on outriggers
- All "on outriggers" loads are based on 85% tipping
- Loads above heavy line are based on structural rating
- Loads below heavy line are based on tipping rating

Data published herein is intended as a guide only. Crane operation is subject to machine specific load charts and information.

JIB LOAD CAPACITIES						
 (ft.)	31 ft. Fixed Jib LMI code #32		30.5 ft. Tele. Jib LMI Code #7		55 ft. Tele. Jib LMI code #13	
		Load Capacity (lbs.)		Load Capacity (lbs.)		Load Capacity (lbs.)
30	80	4,000	79.5	3,300		
35	78	3,850	77.5	3,300	79.5	2,450
40	76	3,700	76	3,300	78	2,450
45	74	3,550	74	3,300	76.5	2,450
50	72	3,400	72	3,300	75	2,450
55	70	3,250	70.5	3,300	73	2,450
60	68	3,080	68.5	3,300	71.5	2,450
65	66	2,910	66.5	3,070	70	2,420
70	64	2,750	64.5	2,750	68	2,260
75	62	2,600	62	2,380	66	2,110

JIB LOAD CAPACITIES						
 (ft.)	31 ft. Fixed Jib LMI code #32		30.5 ft. Tele. Jib LMI Code #7		55 ft. Tele. Jib LMI code #13	
		Load Capacity (lbs.)		Load Capacity (lbs.)		Load Capacity (lbs.)
80	60	2,460	60	2,050	64.5	1,940
85	58	2,320	58	1,760	63	1,750
90	55	2,170	55.5	1,500	61	1,580
95	53	1,930	53	1,260	59	1,440
100	51	1,720	50.5	1,050	57	1,280
105	48	1,530	48	850	55	1,100
110	45	1,350			53	930
115	43	1,200			51	770
120	40	1,020				
125	36	800				

# 40124SHL BOOM DIAGRAM

## - FULLY EXTENDED OUTRIGGER CONFIGURATION -

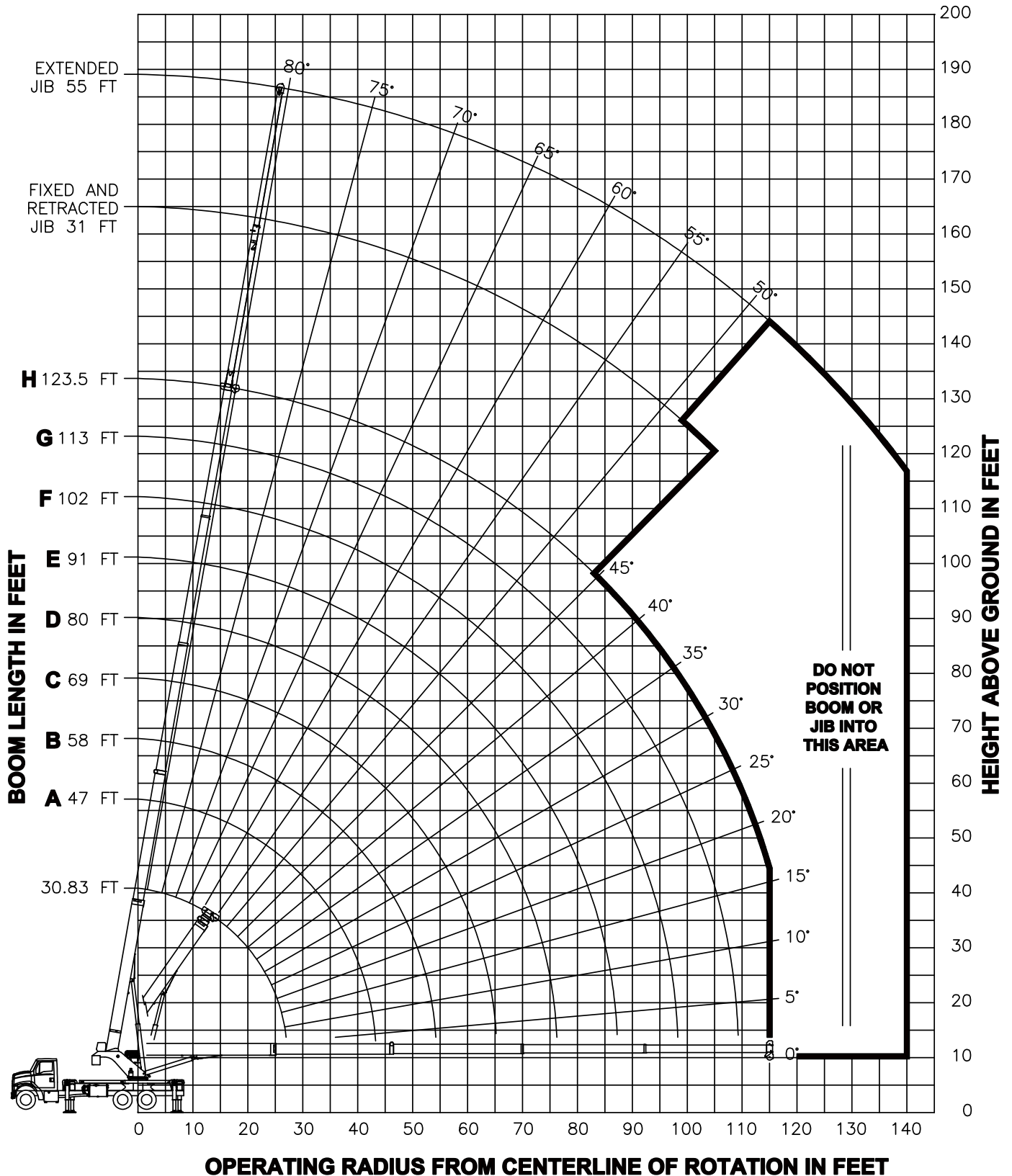

Data published herein is intended as a guide only. Crane operation is subject to machine specific load charts and information.

# AREA OF OPERATION

In order to take advantage of full 360° rotation, the front bumper stabilizer must be set in accordance to the manual before working in this area and machine must be level.

If a front bumper stabilizer was not supplied, then the front tires must be in contact with the ground before working in this area.

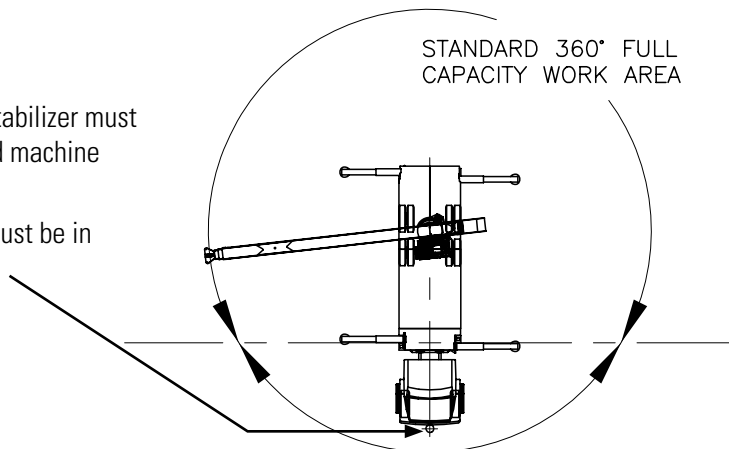

## Deductions from rated loads for load handling devices supplied by Manitex

Auxiliary block	50 lbs. (22.7 kg)
Overhaul ball	See overhaul ball mfr. nameplate
Load blocks	See load block mfr. nameplate
Hose reel	260 lbs. (117.9 kg)
Swing around jib (stowed)	See load chart

**WARNING:** Lifting off the main boom point while the jib is erected is not intended nor approved.

# REEVING DIAGRAM

ALLOWABLE LINE PULL								<b>WARNING</b>
1 PART LINE	2 PART LINE	3 PART LINE	4 PART LINE	5 PART LINE	6 PART LINE	7 PART LINE	8 PART LINE	
								<p>ANTI-TWO-BLOCK SYSTEM MUST BE IN GOOD OPERATING CONDITION BEFORE OPERATING CRANE.</p> <p>REFER TO THE OWNER'S MANUAL.</p> <p>KEEP AT LEAST 3 WRAPS OF LOAD LINE ON THE DRUM AT ALL TIMES.</p>
9500 LBS	19000 LBS	28500 LBS	38000 LBS	47500 LBS	57000 LBS	66500 LBS	76000 LBS	
10000 LBS	20000 LBS	30000 LBS	40000 LBS	50000 LBS	60000 LBS	70000 LBS	80000 LBS	5/8" 6 X 25 IWRC (3.5:1 SF) – 35000 LBS MIN BREAKING STRENGTH

Data published herein is intended as a guide only. Crane operation is subject to machine specific load charts and information.



# LMI OPERATING CODES

Code	Crane Configuration	Outrigger Configuration	Area of Operation
#1	Main Boom	Fully Extended	Full 360°
#32	Fixed Jib	Fully Extended	Full 360°
#7	Telescopic Jib - Retracted	Fully Extended	Full 360°
#13	Telescopic Jib - Extended	Fully Extended	Full 360°
#25	Personnel lifting platform on main boom	Fully Extended	Full 360°
#33	Personnel lifting platform on fixed jib	Fully Extended	Full 360°
#26	Personnel lifting platform on tele. jib - retracted	Fully Extended	Full 360°
#29	Personnel lifting platform on tele. jib - extended	Fully Extended	Full 360°
#4	Main Boom	Mid Extension	Full 360°
#34	Fixed Jib	Mid Extension	Full 360°
#19	Telescopic Jib - retracted	Mid Extension	Full 360°
#22	Telescopic Jib - extended	Mid Extension	Full 360°
#5	Main Boom	Fully Retracted	Full 360°

## Warning

1. The operator must read and understand the owner's manual before operating the crane.
2. Positioning or operation of crane beyond areas shown on these charts is not intended or approved except where specified in owner's manual.
3. Loaded boom angles at specified boom lengths give only an approximation of the operating radius. The boom angle before loading should be greater to account for deflections. Do not exceed the operating radius for rated loads.
4. The operating radius shown in the jib rating chart is for fully extended boom only. When boom is not fully extended, use only loaded boom angle to determine load rating of jib.
5. For boom angles not shown on jib load rating chart, use rating of next lower boom angle.
6. For boom lengths not shown, use rating of next shorter or longer boom length, whichever is less. For radii not shown, use rating of next longer radius.
7. Crane load ratings on outriggers are based on freely suspended loads with the machine leveled and standing on a firm uniform supporting surface. No attempt shall be made to move a load horizontally on the ground in any direction.
8. Practical working loads depend on supporting surface, wind, and other factors affecting stability such as hazardous surroundings, experience of personnel, and proper handling, all of which must be taken into account by the operator.
9. The maximum load which may be telescoped is limited by hydraulic pressure, boom angle, and boom lubrication. It is safe to attempt to telescope any load within the limits of the load rating chart. Boom must be fully retracted against boom stops at all times when lifting minimum boom length capacity loads.
10. Lifting off the main boom point while the swing around jib is erected is not intended or approved.

## Information

1. Deductions must be made from rated loads for stowed jib, optional attachments, hooks, and load blocks (See deduction chart on page 8). Weights of slings and all other load handling devices shall be considered a part of the load.
2. Load ratings above the blue line are structurally limited capacities. Load ratings below the blue line are stability limited capacities and do not exceed 85% of tipping.

## Definitions

1. Operating radius is the horizontal distance from the axis of rotation to the center of the vertical hoist line or tackle with load applied.
2. Loaded boom angle as shown in the column head by  is the included angle between the horizontal and longitudinal axes of the boom base after lifting rated load at rated radius.

# TECHNICAL DESCRIPTIONS

## Boom



Boom lengths: Proportional boom

- 3-section 77 ft. (23,5 m)
- 4-section 100 ft. (30,1 m)
- 5-section 124 ft. (37,8 m)

5-sheave quick reeve boom point

Self lubricating slider pads



Max. tip height 4077S/SHL: 86 ft. (26,2 m)

Max. tip height 40100S/SHL: 108.7 ft. (33,1)

Max. tip height 40124S/SHL: 131.8 ft. (40,2)



Boom angle (min/max): -6° / 80°

## Rotation



Ball-bearing swing circle with external gear

Double-reduction planetary gearbox driven by hydraulic motor



Slewing brake: Spring-applied pressure released automatic brake



Slewing speed: 1.5 - 2 rpm. (nominal)

Boom rotation: 360° continuous

## Outriggers



Outriggers: Out-and-down style

FBS - Front Bumper Stabilizer (optional)

Outrigger monitoring system (for verification only)

Outrigger motion alarm

Full extension

- Front and rear: 22 ft. (6,7 m)

Middle extension

- Front and rear: 14.3 ft. (4,4 m)

Full retraction

- Front and rear: 7.1 ft. (2,2 m)



ROC Solid - Radio operated handheld controller for outrigger and FBS setup

## Operator aids



- Wired LMI with crane function cut-offs for overload protection
- Wired anti-two block system

## Hoist, Rope and Hook



Maximum theoretical line speed:

453 fpm (138 mpm)



Maximum theoretical bottom-layer line pull:

13,050 lbs. (5,919 kg)



Main winch cable diameter: 5/8 in.

(15,9 mm) rotation resistant



Line length: 380 ft. (115,8 m)



Main winch: Bent axis 2-speed hydraulic motor (activated electrically)



Load block: 5T (4.5 mt) capacity hook with heavy-duty swivel and weight is provided for single line operation.

## Hydraulics



8-bolt direct mounted PTO and SAE C output (factory mounted units only)

3-section vane pump, SAE C input

Hydraulic reservoir capacity:

115 gal. (435 L)

Pump sections @ 2000 rpm with 100 psi

- Shaft end pump: 41.67 gpm (158 lpm)
- Center pump: 28.3 gpm (107 lpm)
- Cover end pump: 11.7 gpm (44 lpm)

## Tiltable Cab/Cab Controls



Standard features:

Curved glass, 0° to 20° cab tilt, Automotive door, heated cloth seat, 8 seat adjustments, lumbar support and adjustable head rest, sliding windows, rear pop out window, top hinged hatch, standard diesel fired heater, retractable sun screen, 12 volt DC outlet, E-coated cab (10 year rust warranty)



Controls:

PLC crane controller, CANBUS communication, J1939 truck engine communication capability, electronic hand and foot throttle, Hirschmann/PAT iScout D3 LMI system

# OPTIONS

## Boom

### Max. Tip Height



- 4077S and 4077SHL
- Max. tip height: 86 ft. (26,2 m)
- 40100S & 40100SHL
- Max tip height: 108.7 ft. (33,1m)
- 40124S & 40124SHL
- Max. tip height: 131.8 ft. (40,2 m)

### Jibs

- 40100S, 40100SHL, 40124S & 40124SHL
- 1-section fixed jib: 30.5 ft. (9,3 m)
  - 2-sections telescopic jib: 30.5 ft (9,3 m) - 55 ft. (16,8 m)

### Max. Tip Height with Extension



- 40100S & 40100SHL
- Max tip height with extension: 163.5 ft. (49,8 m)
  - Max tip height with extension retracted: 139.3 ft. (42,4 m)
- 40124S & 40124SHL
- Max. tip height with extension: 186.7 ft. (56,9 m)
  - Max. tip height with extension retracted: 163 ft. (49,7 m)

### Max. Boom Length



- 4077S
- Max. boom length 76.8 ft. (23,4 m)



- 40100S
- Max. boom length with extension: 155 ft. (47,2 m)
- 40124S & 40124SHL
- Max boom length with extension: 178.5 ft. (54,4 m)



- 40100S
- Max. boom length with extension retracted: 130.5 ft. (39,8 m)
- 40124S & 40124SHL
- Max boom length with extension retracted: 154 ft. (46,9 m)

### Bulkhead

24 in. (607 mm) bulkhead

## Hoist and Hook



- Auxiliary winch same as main winch, includes rooster sheave
- Wireline options available
- 2nd overhaul ball available
- 3rd wrap limiter main and auxiliary winch



- Auxiliary lower sheave block for 2-8 part lines
- Load blocks 1-3, 1-6, 2-6 part lines

## Hydraulics



- Hose reel – boom mounted.
- Front Bumper Stabilizer (FBS)

## Cab



- Air conditioner
- Engine monitoring system
- Video camera (1 or 2)
- Cab weather band radio system
- Wireless wind speed indicator

## Operator Aids



- 4-function radio remote crane control system either with paddles or joy sticks
- 900 Mhz
  - 433 Mhz
- Remote Winch Control System for main and auxiliary winches

## 2-person Basket



- Consult Manitex for specific application and rating
- 2-person gravity level basket
  - 2-person rotating steel basket
  - 2-person quick attach rotating basket

## Tool Boxes & Flatbed

- 24 in. L x 18 in. W x 18 in. H  
(610 mm L x 457 mm W x 457 mm H)
- 48 in. L x 24 in. W x 24 in. H  
(1,219 mm L x 610 mm W x 610 mm H)
- 8 ft. (2,4 m) flatbed - wood or steel
- 10 ft. (3 m) flatbed - wood or steel

**Manitex**



# TC400

40-ton (36,3 mt) TELESCOPIC CRANE  
TC400 SERIES PRODUCT GUIDE

**UPTIME**

UPTIME is the Manitex commitment to complete support of thousands of units working every day.

**MANITEX**

3000 South Austin Avenue  
Georgetown, Texas 78626

1-877-314-3390 | [www.Manitex.com](http://www.Manitex.com)