

DIESEL ENGINE PLATFORMS

The answer to PERSONNEL LIFTING REQUIREMENTS



www.manitou.com

Courtesy of Crane.Market

Total Flexibility with MANITOU



INDEX //

Scissor platforms	p. 4
Articulated platforms	p. 8
Telescopic platforms	p. 16
MANITOU services	p. 22
Technical specification	p. 24

Diesel Platforms



As a world leader in all-terrain loading and lifting equipment, MANITOU is known for the **innovation, safety and quality** of its machinery. MANITOU designs and manufactures equipment specifically adapted to the needs of their clients in construction, agriculture and industry. **Reliability, performance and simplicity** of MANITOU machines produce equipment of high added value. So, naturally, the brand has put all its expertise, and that of its distribution chain, to the development of **Diesel-engine platforms for the construction industry.**

You will find a **wide choice of lifting platforms**, each of them corresponding perfectly to the requirements of your business. Whatever the terrain and the application you will have the after sales support to maximise your Manitou diesel platforms efficiency.

**Diesel platforms:
8 models available**



Scissor platforms



3 MODELS AVAILABLE:





(100SC)



(120SC)



(140SC)



Compactness together with high performance.

You have easy access to your building sites thanks to the **compact size** of the Manitou scissor platforms. These **compact and sturdy** models offer, considering their size, impressive working at height capacity and a **large working area**. They are simple to operate and so you gain in flexibility and operating comfort.

“ I have a **mobile workshop** at height. ”



Scissor platforms

100SC/120SC

Ease of handling

Several factors mean that Scissor platforms are **very simple to handle**. Their compactness allows you to **manoeuvre in cluttered spaces**, inside and out. You ascend the machine easily with the help of **large anti-slip steps** and a **gate**. Even when working at height your control of the machine and its movement provide complete safety with **the aid of the intuitive ergonomic control panel**. And you can **control the platform extension** (with the extension on rollerwheels locked in the secured position).



All terrain capability and Safety

Whatever condition the ground is in, you can work with no problem with the aid of the four driving wheels and an axle oscillation. In addition, you can deploy the stabilisers with the control panel located in the basket. In transport position **they are retracted automatically** to avoid damage. The overload indicator informs you the permitted weight so that all is under control.



Robust construction and minimal maintenance

Gradual take up of drive reducing pitching motion. The scissor platform's covers are easily opened. When maintenance is required they provide **easy access** to the engine and hydraulic compartments. The motor itself is mounted on a swiveling base. You will gain invaluable time.



Preferred working areas for **SC** models

- First phase (scaffolding, cladding)
- Second phase (painting, airconditioning, heating insulation...)
- Cleaning, sandblasting
- Event Operations
- ...



Commercial buildings



Event Management

Articulated platforms



4 MODELS AVAILABLE:





(160ATJ)

(160ATJ+)

(180ATJ)

(200ATJ)



You get round all obstacles, even on steep ground.

If you work mainly out of doors, on uneven or steeply sloping ground, this range is the ideal solution. **Height, load, reach, speed of elevation...** The MANITOU Diesel engine articulated platforms are the answer to all your building needs. From 16 to 20 metres, and from 230 to 400 kg (with our 160 ATJ+), you can find **the platform which is most suited to your needs.**



“I can take on all kinds of **very different operations.**”

Articulated platforms

160ATJ/160ATJ+/180ATJ/200ATJ

All Terrain Capability

With **three steering modes, hydrostatic transmission, 2 heavy duty axles, 4 wheel drive, and unrivalled protection over obstacles** on all types of ground. Even a gradient of 40% is within its capabilities and can easily **go round and over obstacles**. The **oscillating axle** (optional) will cope with all the ground irregularities. Your mobility and safety are ensured, whatever the type of terrain.

Efficiency and Productivity

You can reach the most inaccessible areas with ease, whether you are at 16 or 20 metres. Our models offer **the best reach capacity on the market**, equal to the needs of most building sites. Thereby you have access to an **ideal working area without needing to move your machine**. You make the most of your working time and thus your productivity.



160 ATJ New generation

You will find the improvements that have been made to the standard model:

- **easier operation of the controls to allow** you a better control of the power required, thereby significantly reducing polluting emissions, noise and fuel consumption.
- solid wheels, more environmentally friendly than foam filled or polyurethane tyres.

18" wheels are available as an option for use on very restricted site applications, where space is at a premium.



160 ATJ +

- Large basket (2.40 x 0.90 m) and basket capacity (400 kg including 3 people).
- Large storage area for tools and equipment.



Most suitable operating areas for **ATJ** models

- First phase (framework, cladding)
- Second phase (painting, heating and air conditioning)
- Cleaning and sand blasting
- Pruning
- Event Operations
- Airport/Port maintenance
- ...



Framework



Cleaning windows

**“ I have the freedom
for smooth
and precise
movements. ”**



Articulated platforms

160ATJ/160ATJ+/180ATJ/200ATJ



Speed

You really save time at each lift. The raising of the platform consists of **four movements** (spreading of the arms, activation of the telescopic equipment and the turret rotation) which can be done **simultaneously**. So you reach your working area in **40 seconds flat**. Moreover, due to its size and weight, the machine is **easily transportable by lorry** from one job to the next, You do not waste a minute.

Robustness

With the ATJ platform, you can work at height with total peace of mind. The **heavy duty arms** increase the machines rigidity and add to **the comfort of use at height**. The control box is protected by a cover against dirty operations such as painting, high pressure cleaning. The **cover equally acts as protection** against extreme weather or acts of vandalism, and keeps your machine in good condition to maintain its resale value.



Working comfort

The ergonomic control box is designed to **facilitate manoeuvring** and to avoid accidents. The raising of the platform and the travel mode movement levers are located distinctly on the control panel. With your right hand, you can use all the moving control functions. **You are the master of the mobility of your machine**. The spacious basket with its grid design floor provides you with comfort and good visibility to ground level. It is fitted with double handrails to protect the operator's hands, but also has a solid toolbox. With MANITOU, comfort and safety go hand-in-hand.

Most suitable operating areas for ATJ models

- First phase (framework, cladding)
- Second phase (painting, heating and air conditioning)
- Cleaning and sand blasting
- Pruning
- Event Operations
- Airport/Port maintenance
- ...



Tree pruning



Sporting events

**“I have a workface of
almost 360 degrees
without needing to move.”**



Articulated platforms

160ATJ/160ATJ+/180ATJ/200ATJ

Safety

In accordance with **European directives**, ATJ platforms have all the **necessary systems of protection**:

- **dead man's pedal** to avoid incorrect operator actions e.g. in case of the operator's drowsiness or illness
- **safety valves** on the lifting controls
- **control panel in the basket and also on the ground** (to help out an operator in difficulty)
- **weight control, leaning angle detector**
- negative braking
- electric **emergency pump**
- puncture proof tyres

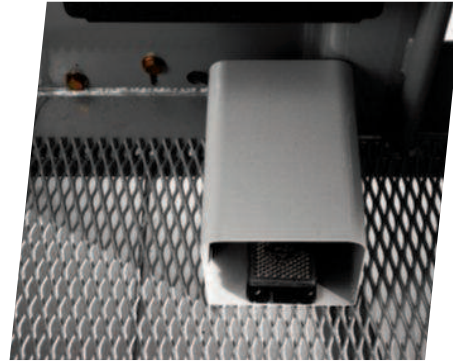

Simplified maintenance

The **integrated bus CAN technology** enables you to **verify speedily the state** of your machine. A monitor provides immediate feedback on the platform highlighting any service action required. The MANITOU dealer can assist with the diagnostics. By opening the cover, technicians have **easy access to all service points and major components**. You thus significantly **reduce your maintenance and non-activity costs**.



Most suitable operating areas for ATJ models

- First phase (framework, cladding)
- Second phase (painting, heating and air conditioning)
- Cleaning and sand blasting
- Pruning
- Event Operations
- Airport/Port maintenance
- ...



Port maintenance



Airports

Telescopic platforms



1 MODEL AVAILABLE:





(280TJ)

You can reach the heights.

Manitou Diesel Platforms with telescopic jibs are ideal for **working at height**. They have shown themselves to be indispensable for operations which demand a **significant reach span**, such as on major building construction sites. They are equipped with **high specification components** providing excellent reach and rough terrain capability for maximum safety and efficiency, with a controlled working speed... you are assured of the ability to work in all site conditions in total confidence.



**“ I work
on large sites with
confidence. ”**



Telescopic platforms

280TJ

All terrain capability

With their different **steering systems**, TJ models can get **round and over obstacles** on every kind of ground. These platforms are significantly lighter and more compact than most of the competition leading to less ground damage and greater ease of transportation. Reinforced floors, an oscillating axle, 4 wheel drive and a differential block guarantee maximum mobility and speed on all surfaces.



Rapidity and safety of movements

You will really save time. The raising of the platform is effected in **proportional simultaneous movements**, offering **speed and flexibility**. You reach your working area fast and efficiently. Electronic control of the movements also allows rapidity of forward movement of the fixed basket in the air (the speed of movement of the basket is the same, whether the telescopic element is extended or not).



Excellent reach capability

Our platforms are equipped with a pivot system at the foot of the jib which provides an impressive reach capability. With the aid of the telescopic facility you can work **at increasing height levels with ease**. The machine also has an **automatic system for the lifting and telescopic movements**, which allows you to make **vertical and horizontal movements** (for instance along a ceiling).



Most suitable operating areas for TJ models

- First phase (framework)
- Cleaning, sandblasting
- Tree pruning
- Sporting events
- Shipyards
- ...



Construction and Industrial



Shipyards

Scissor platforms

Articulated platforms

Telescopic platforms

“Working at heights such as this has become a necessity in my job.”



Telescopic platforms

280TJ

Working comfort

With a **full specification basket** and with **the capacity to load up to 350 kg**, you can lift up to **THREE operators with their equipment**. You thus increase your **productivity** by reducing the number of passes. **The storage area (1.80 m)** allows you to store tools and equipment. The TJ models also have **intuitive and ergonomic controls**.

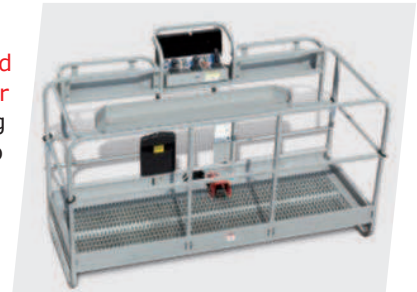

Maintenance and safety

All the expertise developed and tested with ATJ (articulated) models is in evidence with the telescopic platforms: **bus CAN technology** and all the **protection systems** in accordance with European safety directives (electric emergency pump, Dead Man's Pedal etc).

The engine, placed on a swiveling base, allows mechanics easy access to all parts and all service points.



Energy saving

On board system giving you power on demand. Manitou allows you to optimise engine power and complies to international emission regulations while consuming less fuel.

Most suitable operating areas for TJ models

- First phase (frames)
- Cleaning, sandblasting
- Tree pruning
- Sporting events
- Shipyards
- ...



Tree pruning



Cleaning

Scissor platforms

Articulated platforms

Telescopic platforms

Services MANITOU

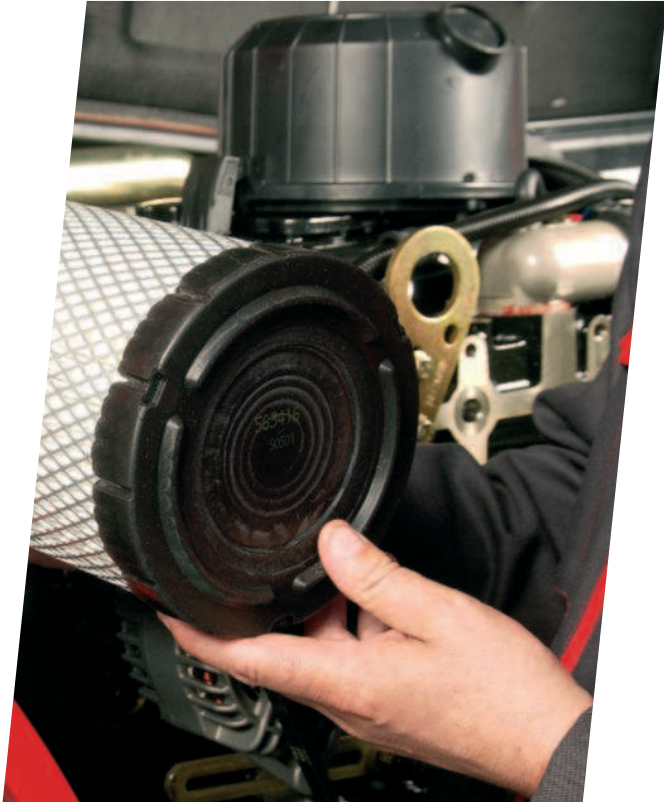

First Class Parts and Service Support

The MANITOU Dealer network is at your service! In addition to geographical proximity, you can rely on the technical expertise and advice of your MANITOU agents, at the time of purchase, and throughout the life of your machine. To help you work in the best possible conditions, MANITOU provides you with the best possible speed of delivery of spare parts for your equipment.





Responsive and technical expertise

For the technical support on your equipment you can rely on experienced professionals! You also can have the peace of mind of every MANITOU owner by calling on MANITOU experts, regularly retrained over the range of our products and available to answer your questions, whether you are an owner-operator or hirer. Maintenance and repair works are carried out on site following a simple telephone call, and in the time-frame agreed, According to your system of management you can plan and spread your maintenance charges and benefit from our offers of maintenance contract and/or extension of guarantee.

Made-to-measure financing to protect your budget









You can plan the purchase of your platform with peace of mind using the MANITOU financing schemes. You have access to solutions that are simple and adapted to your needs and to the season. If you wish to make a speedy investment without exceeding your available funds, you should consider asking us for a tailor-made approach which takes your financial situation into account.

* Manitou finance solutions available in certain countries.



“ I can count on the reliability of the MANITOU equipment and their personnel. ”

100SC

	100 SC
 Working height	9.90 m
Platform height	7.90 m
 Capacity	680 kg
Number of persons (indoor/outdoor)	4/4
Basket (width and length)	2.79 x 1.60 m
 1. Overall width	1.75 m
2. Overall length	3.76 m
3. Overall height	2.59 m
4. Overall length (with extension)	4.61 m
5. Overall height when folded	1.92 m
6. Ground clearance	0.24 m
7. Wheelbase	2.29 m
Inside turning circle	2.11 m
Outside turning circle	4.60 m
 Speed of forward movement	5.6 kph
Working speed	0.5 kph
Lifting/Lowering time of ascent/descent	26/33 secs
 Maximum slope accessible	40 %
 Tyres	26 x 12 x 380
Driving wheels	4
Steering/directional wheels	2
 Weight (varies according to options & standards of the country)	3701 kg
 Engine	KUBOTA D1105
Power	25 HP
Environmental noise (LwA)	105 dB

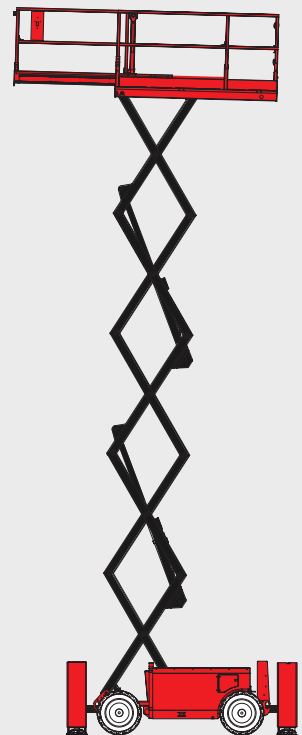
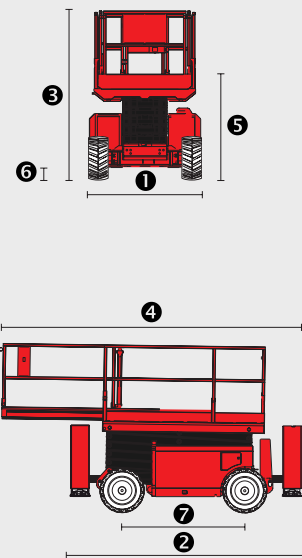









Standard equipment

- Oscillating front axle
- Proportional levers
- Outriggers with automatic levelling
- Anti slip protection
- Access gate for platform
- Folding guardrails
- Removable control box
- Audible and visual display alarm for excessive slope
- Descent Alarm
- Flashing lights
- Foam filled tyres
- On Board Diagnostics
- Hour meter
- Horn
- Beacon
- Audible and visual display alarm for excessive slope
- Predisposition 230V

Optional equipment

- Predisposition compressed air
- Predisposition of water
- Working light
- Biodegradable oil
- Warning Alarm for all movements
- Non Marking tyres
- Certificate of verification
- Safety harness

120SC

	120 SC
 Working height	11.96 m
Platform height	9.96 m
 Capacity	454 kg
Number of persons (indoor/outdoor)	4/2
Basket (width and length)	2.79 x 1.60 m
 1. Overall width	1.75 m
2. Overall length	3.76 m
3. Overall height	2.59 m
4. Overall length (with extension)	4.61 m
5. Overall height when folded	1.92 m
6. Ground clearance	0.24 m
7. Wheelbase	2.29 m
Inside turning circle	2.11 m
Outside turning circle	4.60 m
 Speed of forward movement	5.6 kph
Working speed	0.5 kph
Lifting/Lowering time of ascent/descent	42/28 secs
 Maximum slope accessible	35%
 Tyres	26 x 12 x 380
Driving wheels	4
Steering/directional wheels	2
 Weight (varies according to options & standards of the country)	3882 kg
 Engine	KUBOTA D1105
Power	25 HP
Environmental noise (LwA)	105 dB

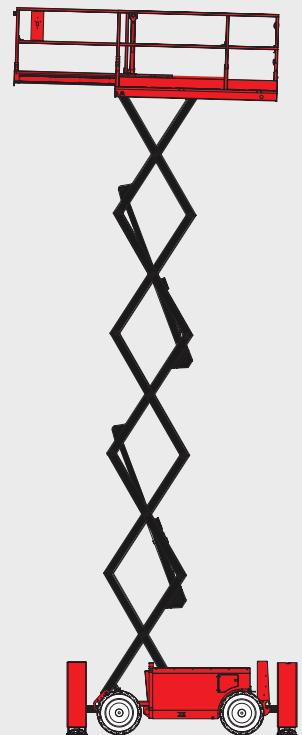
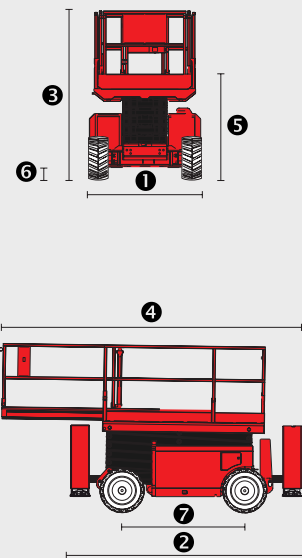

Standard equipment

- Oscillating front axle
- Proportional levers
- Outriggers with automatic levelling
- Anti slip protection
- Access gate for platform
- Folding guardrails
- Removable control box
- Audible and visual display alarm for excessive slope
- Descent Alarm
- Flashing lights
- Foam filled tyres
- On Board Diagnostics
- Hour meter
- Horn
- Beacon
- Audible and visual display alarm for excessive slope
- Predisposition 230V

Optional equipment

- Predisposition compressed air
- Predisposition of water
- Working light
- Biodegradable oil
- Warning Alarm for all movements
- Non Marking tyres
- Certificate of verification
- Safety harness









This brochure describes versions and configuration options for MANITOU products which may be fitted with different equipment. The equipment described in this brochure may be standard, optional or not available depending on version. MANITOU reserves the right to change the specifications shown and described at any time and without prior warning. The manufacturer is not liable for the specifications given. For more information, contact your MANITOU dealer. Non-contractual document. Product descriptions may differ from actual products. List of specifications is not comprehensive. The logos and visual identity of the company are the property of MANITOU and may not be used without authorisation. All rights reserved. The photos and diagrams contained in this brochure are provided for information only.

MANITOU BF SA - Limited company with board of directors - Share capital: 39,547,824 euros - 857 802 508 RCS Nantes



FT039EN_A_0313_120SC.indd

140SC

		140 SC
	Working height	14.20 m
	Platform height	12.20 m
	Capacity	363 kg
	Number of persons (indoor/outdoor)	3/2
	Basket (width and length)	2.79 x 1.60 m
	1. Overall width	1.75 m
	2. Overall length	3.76 m
	3. Overall height	2.74 m
	4. Overall length (with extension)	4.61 m
	5. Overall height when folded	2.08 m
	6. Ground clearance	0.24 m
	7. Wheelbase	2.29 m
	Inside turning circle	2.11 m
	Outside turning circle	4.60 m
	Speed of forward movement	5.6 kph
	Working speed	0.5 kph
	Lifting/Lowering time of ascent/descent	69/46 secs
	Maximum slope accessible	35%
	Tyres	26 x 12 x 380
	Driving wheels	4
	Steering/directional wheels	2
	Weight (varies according to options & standards of the country)	5039 kg
	Engine	KUBOTA D1105
	Power	25 HP
	Environmental noise (LWA)	105 dB

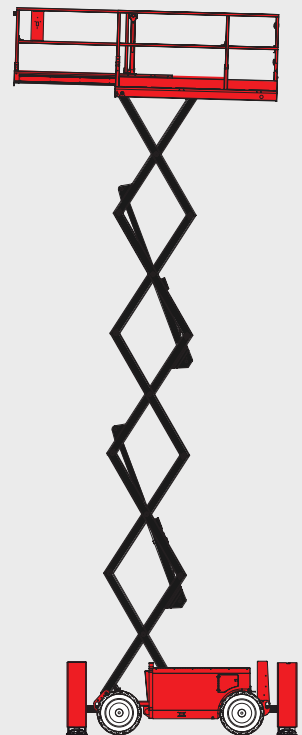
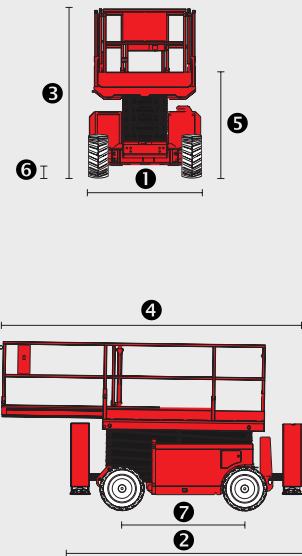

Standard equipment

- Oscillating front axle
- Proportional levers
- Outriggers with automatic levelling
- Anti slip protection
- Access gate for platform
- Folding guardrails
- Removable control box
- Audible and visual display alarm for excessive slope
- Descent Alarm
- Flashing lights
- Foam filled tyres
- On Board Diagnostics
- Hour meter
- Horn
- Beacon
- Audible and visual display alarm for excessive slope
- Predisposition 230V

Optional equipment

- Predisposition compressed air
- Predisposition of water
- Working light
- Biodegradable oil
- Warning Alarm for all movements
- Non Marking tyres
- Certificate of verification
- Safety harness

This brochure describes versions and configuration options for MANITOU products which may be fitted with different equipment. The equipment described in this brochure may be standard, optional or not available depending on version. MANITOU reserves the right to change the specifications shown and described at any time and without prior warning. The manufacturer is not liable for the specifications given. For more information, contact your MANITOU dealer. Non-contractual document. Product descriptions may differ from actual products. List of specifications is not comprehensive. The logos and visual identity of the company are the property of MANITOU and may not be used without authorisation. All rights reserved. The photos and diagrams contained in this brochure are provided for information only.

MANITOU BF SA - Limited company with board of directors - Share capital: 39,547,824 euros - 857 802 508 RCS Nantes



160 ATJ

		160 ATJ
	Working height	16.01 m
	Platform height	14.01 m
	Articulation height	7.38 m
	Outreach	8.30 m
	Jib tilting	+70°/-70°
	Basket rotation	+90°/-90°
	Turret rotation	350°
	Capacity	230 kg
	Number of persons (indoor/outdoor)	2/2
	Basket (width and length)	1.80 x 0.80 m
	1. Overall width	2.30 m
	2. Overall length	6.53 m
	3. Overall height	2.37 m
	4. Overall length when folded	4,44 m
	5. Overall height when folded	2.61 m
	6. Inside turning circle	1.39 m
	7. Outside turning circle	3.71 m
	8. Turning Radius (basket)	5.94 m
	9. Ground clearance	35.5 cm
	10. Wheelbase	2.20 m
	Speed of forward movement	6 kph
	Working speed	0.80 kph
	Maximum slope accessible	40 %
	Maximum tilt	5° - 9%
	Tyres	16.5"
	Driving wheels	4
	Steering/directional wheels	4
	Weight	6160 kg
	<small>(varies according to options & standards of the country)</small>	
	Engine	KUBOTA V1505-E3B
	Power	35.1 HP
	Environmental noise (LwA)	101 dB

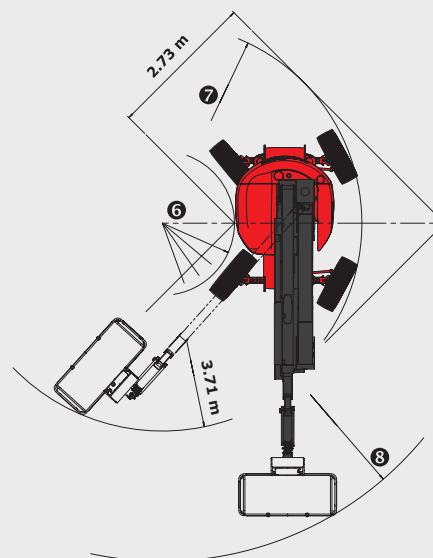
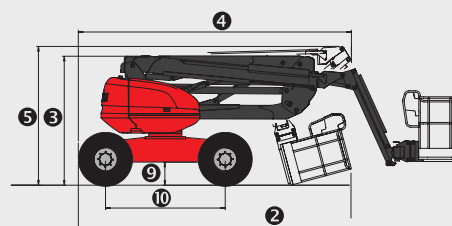
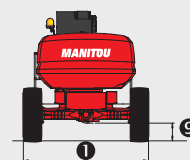
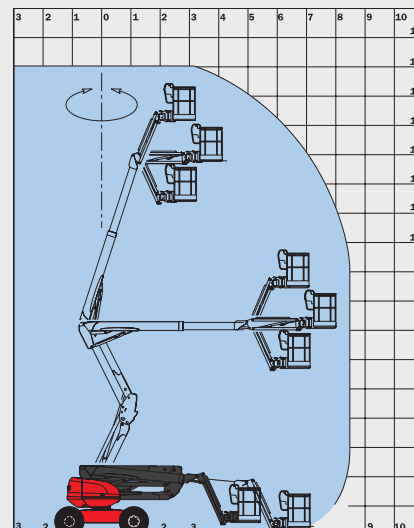

Standard equipment

Proportional levers
4 simultaneous movements
4 wheel drive
4 wheel steer
Wheels crab position
Solidair Tyres
Differential Lock
Front Axle limited slip differential
On Board Diagnostics
Hour meter
Fuel gauge with low level warning
Tool box
Protective cover with optional locking
Horn
Beacon
Audible and visual display alarm for excessive slope
Code Protected Machine Set Up
Hooks for sling loading/lifting
Electric Pump
Predisposition 230V
Dead man pedal

Optional equipment

2 Wheel steer
Oscillating Axle
Continuous Rotation
Onboard generator (3.50 kVA)
230V power input with differential circuit-breaker
Predisposition of water
Working light
Special paint
Biodegradable oil
Warning Alarm for all movements
Warning Travel Alarm
Catalytic Converter
Spark Arrester and overrun valve
Anti Theft code
18" Wheels
Certificate of verification
Safety harness
High capacity battery

This brochure describes versions and configuration options for MANITOU products which may be fitted with different equipment. The equipment described in this brochure may be standard, optional or not available depending on version. MANITOU reserves the right to change the specifications shown and described at any time and without prior warning. The manufacturer is not liable for the specifications given. For more information, contact your MANITOU dealer. Non-contractual document. Product descriptions may differ from actual products. List of specifications is not comprehensive. The logos and visual identity of the company are the property of MANITOU and may not be used without authorisation. All rights reserved. The photos and diagrams contained in this brochure are provided for information only.

MANITOU BF SA - Limited company with board of directors - Share capital: 39,547,824 euros - 857 802 508 RCS Nantes



FT041EN_A_0313_160ATJ.indd

160 ATJ +

		160 ATJ +
	Working height	16.25 m
	Platform height	14.25 m
	Articulation height	7.00 m
	Jib tilting	+70°/-70°
	Basket rotation	+90°/-90°
	Turret rotation	350°
	Capacity	400 kg
	Number of persons (indoor/outdoor)	2/2
	Basket (width and length)	2.30 x 0.93 m
	1. Overall width	2.30 m
	2. Overall length	6.93 m
	3. Overall height	2.37 m
	4. Overall length when folded	4.94 m
	5. Overall height when folded	2.70 m
	6. Inside turning circle	1.32 m
	7. Outside turning circle	3.68 m
	8. Turning Radius (basket)	6.39 m
	9. Ground clearance	42.5 cm
	10. Wheelbase	2.20 m
	Speed of forward movement	6 kph
	Working speed	0.80 kph
	Maximum slope accessible	40 %
	Maximum tilt	5° - 9 %
	Tyres	18"
	Driving wheels	4
	Steering/directional wheels	4
	Weight	8100 kg
	<small>(varies according to options & standards of the country)</small>	
	Engine	KUBOTA V2403-M
	Power	45 HP
	Environmental noise (LwA)	101 dB

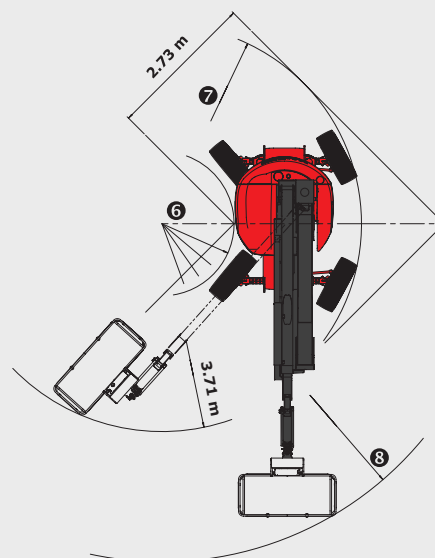
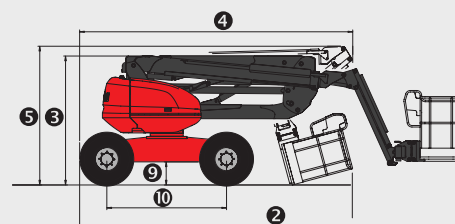
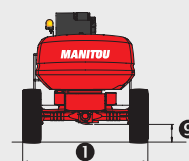
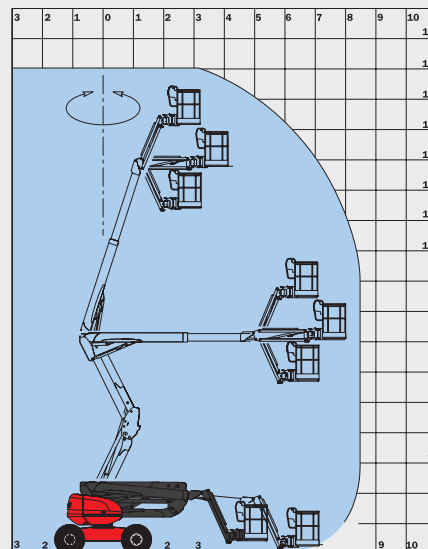

Standard equipment

- Large Basket
- Proportional levers
- 4 simultaneous movements
- 4 wheel drive
- 4 wheel steer
- Wheels crab position
- Foam filled tyres
- Differential Lock
- Front Axle limited slip differential
- On Board Diagnostics
- Hour meter
- Fuel gauge with low level warning
- Tool box
- Protective cover with optional locking
- Horn
- Beacon
- Audible and visual display alarm for excessive slope
- Code Protected Machine Set Up
- Hooks for sling loading/lifting
- Electric Pump
- Predisposition 230V
- Dead man pedal

Optional equipment

- Oscillating Axle
- Continuous Rotation
- Onboard generator (3.50 kVA)
- Onboard generator (5.50 kVA)
- High capacity battery
- 230V power input with differential circuit-breaker
- Predisposition compressed air
- Predisposition of water
- Working light
- Special paint
- Biodegradable oil
- Warning Alarm for all movements
- Warning Travel Alarm
- Catalytic Converter
- Spark Arrester and overrun valve
- Anti Theft code
- 20" Wheels
- Non Marking tyres
- Certificate of verification
- Safety harness
- High capacity battery

This brochure describes versions and configuration options for MANITOU products which may be fitted with different equipment. The equipment described in this brochure may be standard, optional or not available depending on version. MANITOU reserves the right to change the specifications shown and described at any time and without prior warning. The manufacturer is not liable for the specifications given. For more information, contact your MANITOU dealer. Non-contractual document. Product descriptions may differ from actual products. List of specifications is not comprehensive. The logos and visual identity of the company are the property of MANITOU and may not be used without authorisation. All rights reserved. The photos and diagrams contained in this brochure are provided for information only.

MANITOU BF SA - Limited company with board of directors - Share capital: 39,547,824 euros - 857 802 508 RCS Nantes



180 ATJ

		180 ATJ
	Working height	17.65 m
	Platform height	15.65 m
	Articulation height	7.15 m
	Outreach	10.60 m
	Jib tilting	+70°/-70°
	Basket rotation	+90°/-90°
	Turret rotation	350°
	Capacity	230 kg
	Number of persons (indoor/outdoor)	2/2
	Basket (width and length)	1.80 x 0.80 m
	1. Overall width	2.30 m
	2. Overall length	7.77 m
	3. Overall height	2.37 m
	4. Overall length when folded	5.77 m
	5. Overall height when folded	2.53 m
	6. Inside turning circle	1.32 m
	7. Outside turning circle	3.66 m
	8. Turning Radius (basket)	6.87 m
	9. Ground clearance	42.5 cm
	10. Wheelbase	2.20 m
	Speed of forward movement	6 kph
	Working speed	0.80 kph
	Maximum slope accessible	40 %
	Maximum tilt	5° - 9 %
	Tyres	18"
	Driving wheels	4
	Steering/directional wheels	4
	Weight	8090 kg
	<small>(varies according to options & standards of the country)</small>	
	Engine	KUBOTA V2403-M
	Power	45 HP
	Environmental noise (LwA)	101 dB

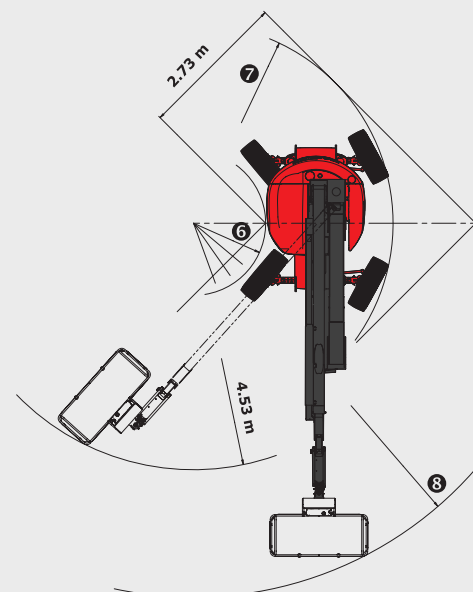
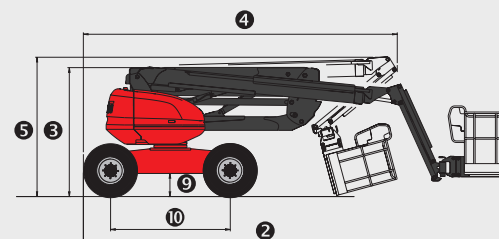
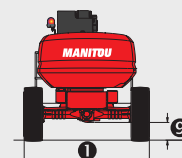
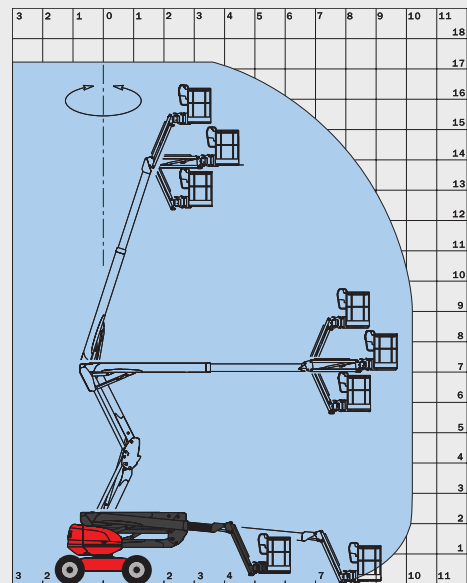

Standard equipment

Proportional levers
4 simultaneous movements
4 wheel drive
4 wheel steer
Wheels crab position
Foam filled tyres
Differential Lock
Front Axle limited slip differential
On Board Diagnostics
Hour meter
Fuel gauge with low level warning
Tool box
Protective cover with optional locking
Horn
Beacon
Audible and visual display alarm for excessive slope
Code Protected Machine Set Up
Hooks for sling loading/lifting
Electric Pump
Predisposition 230V
Dead man pedal

Optional equipment

Oscillating Axle
Continuous Rotation
Wide Basket (2m10 x 0m80) with 20"
Onboard generator (3.50 kVA)
230V power input with differential circuit-breaker
Predisposition compressed air
Predisposition of water
Working light
Special paint
Biodegradable oil
Warning Alarm for all movements
Warning Travel Alarm
Catalytic Converter
Spark Arrester and overrun valve
Anti Theft code
20" Wheels
Non Marking tyres
Certificate of verification
Safety harness
High capacity battery

This brochure describes versions and configuration options for MANITOU products which may be fitted with different equipment. The equipment described in this brochure may be standard, optional or not available depending on version. MANITOU reserves the right to change the specifications shown and described at any time and without prior warning. The manufacturer is not liable for the specifications given. For more information, contact your MANITOU dealer. Non-contractual document. Product descriptions may differ from actual products. List of specifications is not comprehensive. The logos and visual identity of the company are the property of MANITOU and may not be used without authorisation. All rights reserved. The photos and diagrams contained in this brochure are provided for information only.

MANITOU BF SA - Limited company with board of directors - Share capital: 39,547,824 euros - 857 802 508 RCS Nantes



FT043EN_A_0313_180ATJ.indd

200 ATJ

		200 ATJ
	Working height	20.00 m
	Platform height	18.00 m
	Articulation height	8.00 m
	Outreach	12.00 m
	Jib tilting	+70°/-70°
	Basket rotation	+90°/-90°
	Turret rotation	355°
	Capacity	230 kg
	Number of persons (indoor/outdoor)	2/2
	Basket (width and length)	2.10 x 0.80 m
	1. Overall width	2.40 m
	2. Overall length	8.50 m
	3. Overall height	2.70 m
	4. Overall length when folded	6.30 m
	5. Overall height when folded	3.15 m
	6. Inside turning circle	1.30 m
	7. Outside turning circle	3.95 m
	8. Turning Radius (basket)	7.45 m
	9. Ground clearance	43 cm
	10. Wheelbase	2.40 m
	Speed of forward movement	4.70 kph
	Working speed	0.80 kph
	Maximum slope accessible	40 %
	Maximum tilt	5° - 9%
	Tyres	20"
	Driving wheels	4
	Steering/directional wheels	4
	Weight	10 000 kg
	<small>(varies according to options & standards of the country)</small>	
	Engine	KUBOTA V2403-M
	Power	45 HP
	Environmental noise (LWA)	101 dB

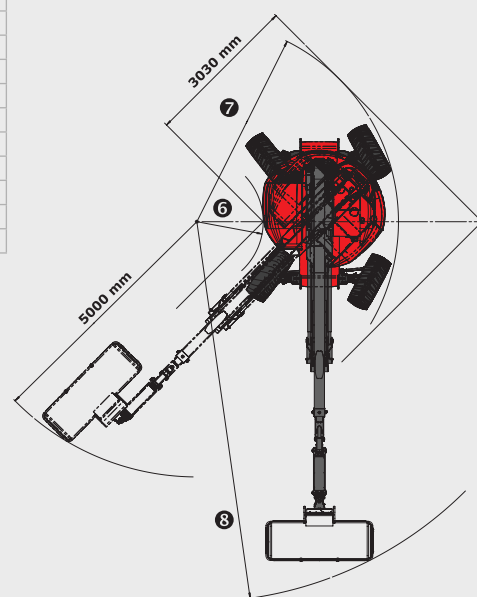
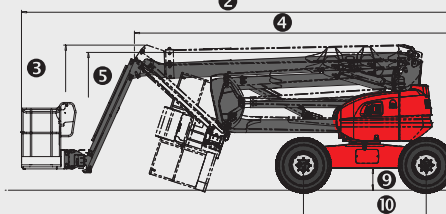
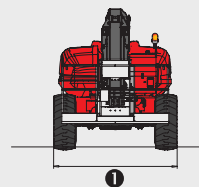
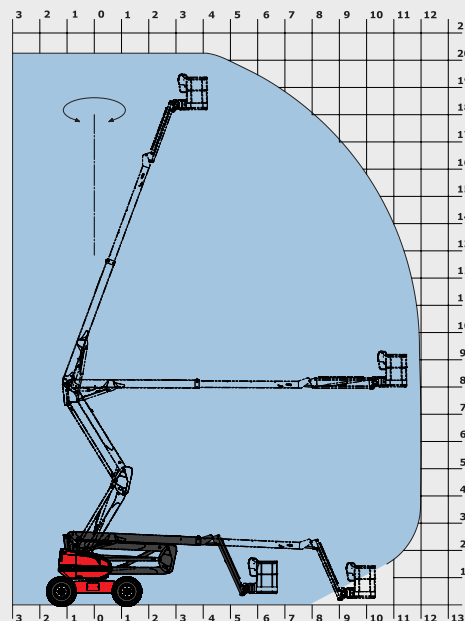

Standard equipment

- Proportional levers
- 4 simultaneous movements
- 4 wheel drive
- 4 wheel steer
- Wheels crab position
- Foam filled tyres
- Differential Lock
- Front Axle limited slip differential
- On Board Diagnostics
- Hour meter
- Fuel gauge with low level warning
- Tool box
- Protective cover with optional locking
- Horn
- Beacon
- Audible and visual display alarm for excessive slope
- Code Protected Machine Set Up
- Hooks for sling loading/lifting
- Electric Pump
- Predisposition 230V
- Dead man pedal

Optional equipment









- Oscillating Axle
- Continuous Rotation
- Onboard generator (3.50 kVA)
- Onboard generator (5 kVA)
- 230V power input with differential circuit-breaker
- Predisposition compressed air
- Predisposition of water
- Working light
- Special paint
- Biodegradable oil
- Warning Alarm for all movements
- Warning Travel Alarm
- Catalytic Converter
- Spark Arrester and overrun valve
- Anti Theft code
- Certificate of verification
- Safety harness
- High capacity battery

This brochure describes versions and configuration options for MANITOU products which may be fitted with different equipment. The equipment described in this brochure may be standard, optional or not available depending on version. MANITOU reserves the right to change the specifications shown and described at any time and without prior warning. The manufacturer is not liable for the specifications given. For more information, contact your MANITOU dealer. Non-contractual document. Product descriptions may differ from actual products. List of specifications is not comprehensive. The logos and visual identity of the company are the property of MANITOU and may not be used without authorisation. All rights reserved. The photos and diagrams contained in this brochure are provided for information only.

MANITOU BF SA - Limited company with board of directors - Share capital: 39,547,824 euros - 857 802 508 RCS Nantes



280 TJ

		280 TJ
	Working height	27.75 m
	Platform height	25.75 m
	Outreach	21.45 m
	Jib tilting	+70°/-70°
	Basket rotation	+90°/-90°
	Turret rotation	continuous
	Capacity	350 kg (3 pers.) 240 kg (2 pers.)
	Basket (width and length)	2.30 x 0.90 m
	1. Overall width	2.43 m
	2. Overall length	11.35 m
	3. Overall height	2.75 m
	4. Overall length when folded	8.04 m
	5. Overall height when folded	2.72 m
	6. Inside turning circle	2.00 m
	7. Outside turning circle	4.33 m
	8. Turning Radius (basket)	9.75 m
	9. Ground clearance	43 cm
	10. Wheelbase	2.80 m
	Speed of forward movement	4.70 kph
	Working speed	0.80 kph
	Maximum slope accessible	40 %
	Maximum tilt	4°
	Tyres	385/45-28
	Driving wheels	4
	Steering/directional wheels	4
	Weight (varies according to options & standards of the country)	16 500 kg
	Engine	KUBOTA V2403-M
	Power	45 HP
	Environmental noise (LWA)	105 dB

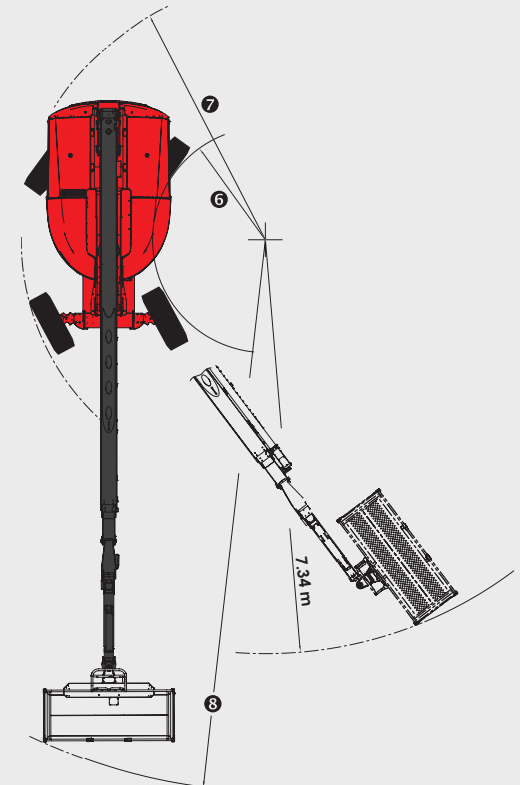
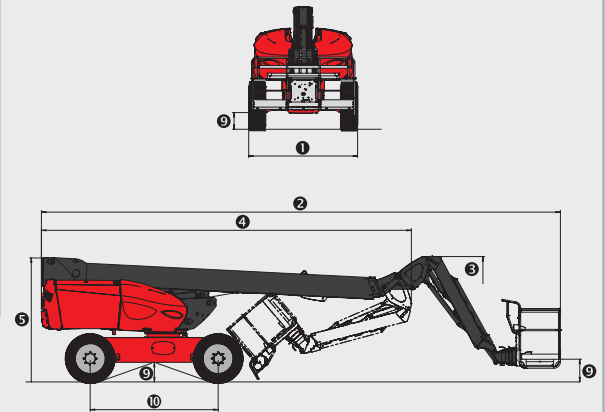
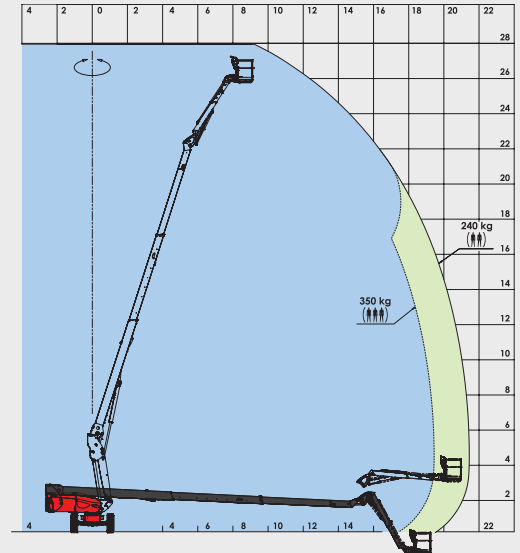

Standard equipment

Telescopic Jib
Oscillating front axle
Continuous Rotation
Large Basket
Proportional levers
4 simultaneous movements
4 wheel drive
4 wheel steer
Wheels crab position
Mouvements X/Y (horizontaux, verticaux)
Foam filled tyres
Differential Lock
Front Axle limited slip differential
On Board Diagnostics
Hour meter
Fuel gauge with low level warning
Tool box
Protective cover with optional locking
Horn
Beacon
Audible and visual display alarm for excessive slope
Code Protected Machine Set Up
Hooks for sling loading/lifting
Electric Pump
Predisposition 230V
Dead man pedal

Optional equipment

Onboard generator (5 kVA)
230V power input with differential circuit-breaker
Predisposition compressed air
Predisposition of water
Working light
Special paint
Biodegradable oil
Warning Alarm for all movements
Warning Travel Alarm
Catalytic Converter
Spark Arrester and overrun valve
Anti Theft code
Certificate of verification
Safety harness

This brochure describes versions and configuration options for MANITOU products which may be fitted with different equipment. The equipment described in this brochure may be standard, optional or not available depending on version. MANITOU reserves the right to change the specifications shown and described at any time and without prior warning. The manufacturer is not liable for the specifications given. For more information, contact your MANITOU dealer. Non-contractual document. Product descriptions may differ from actual products. List of specifications is not comprehensive. The logos and visual identity of the company are the property of MANITOU and may not be used without authorisation. All rights reserved. The photos and diagrams contained in this brochure are provided for information only.

MANITOU BF SA - Limited company with board of directors - Share capital: 39,547,824 euros - 857 802 508 RCS Nantes



Your nearest **MANITOU** dealer:



Head office:
B.P. 249 - 430 rue de l'Aubinière - 44158 Ancenis Cedex - France
Tel: 00 33 (0)2 40 09 10 11 - Fax: 00 33 (0)2 40 09 10 97
www.manitou.com