





# SMH 184

## Triverter 444

-  Gru automatica idraulica
-  Automatic hydraulic crane
-  Automatischer hydraulischer kran
-  Grúa automática hidráulica
-  Grue automatique hydraulique

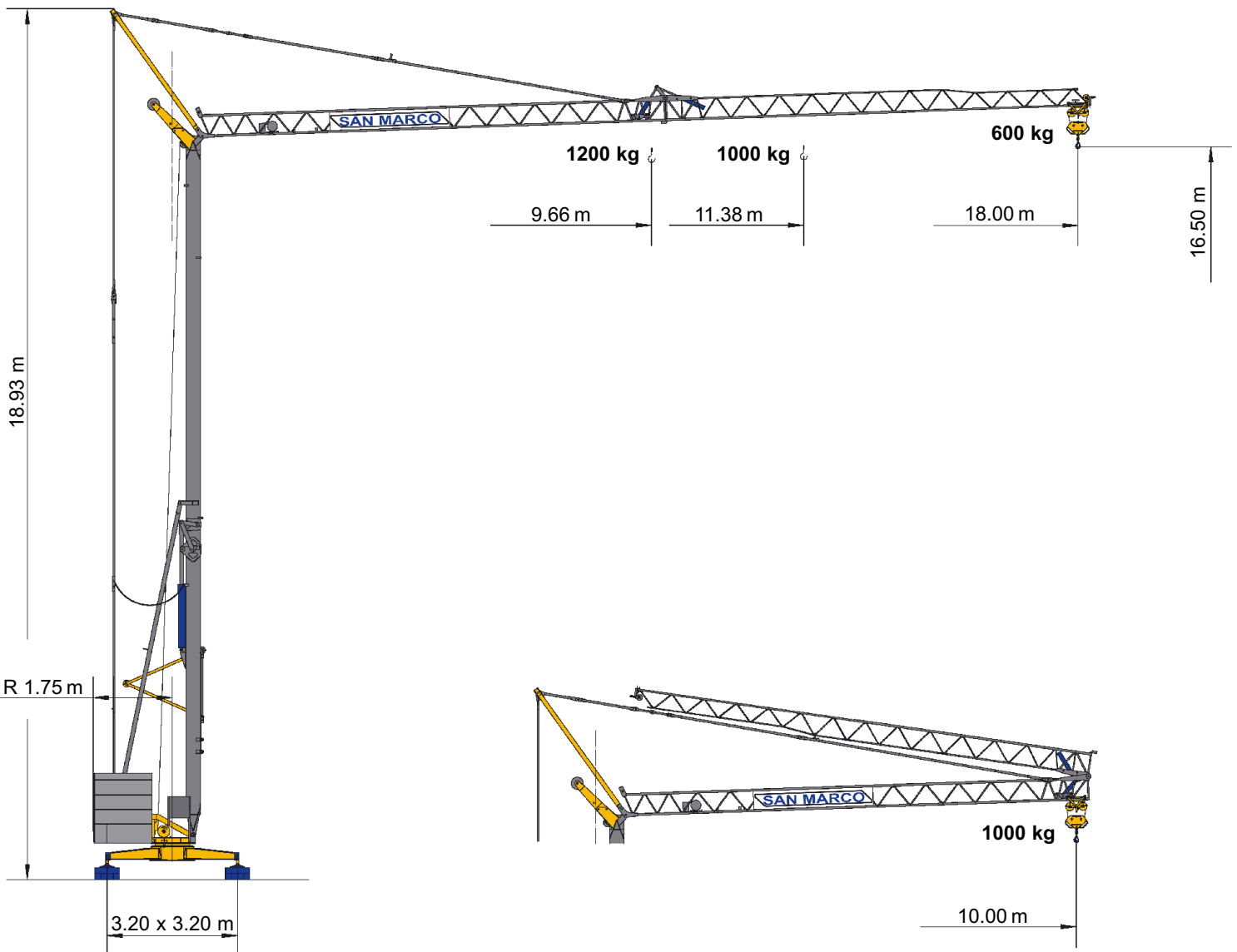
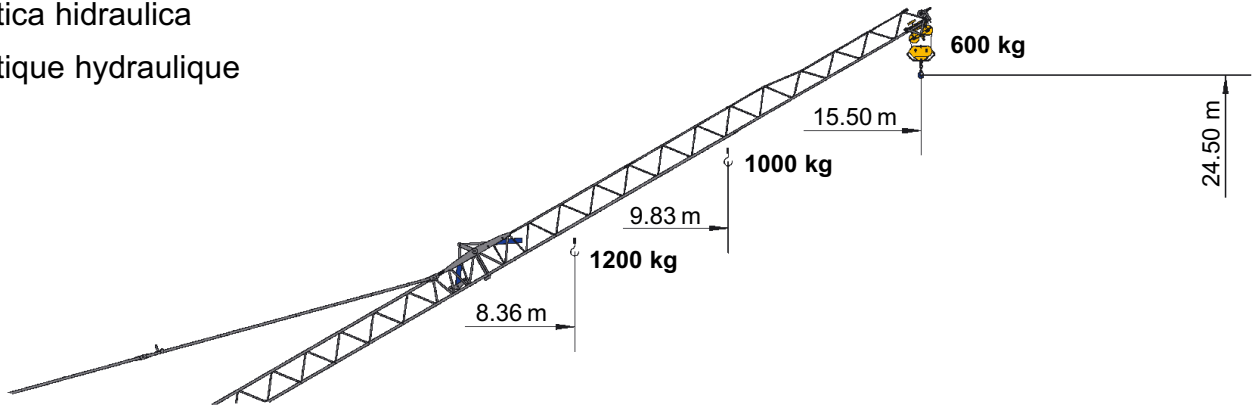

Gru automatica idraulica

Automatic hydraulic crane

Automatischer hydraulischer kran

Grua automatica hidraulica

Grue automatique hydraulique

 Montaggio

 Erection

 Montage

 Montaje

 Montage

	T	M
kW	1.5	1.8

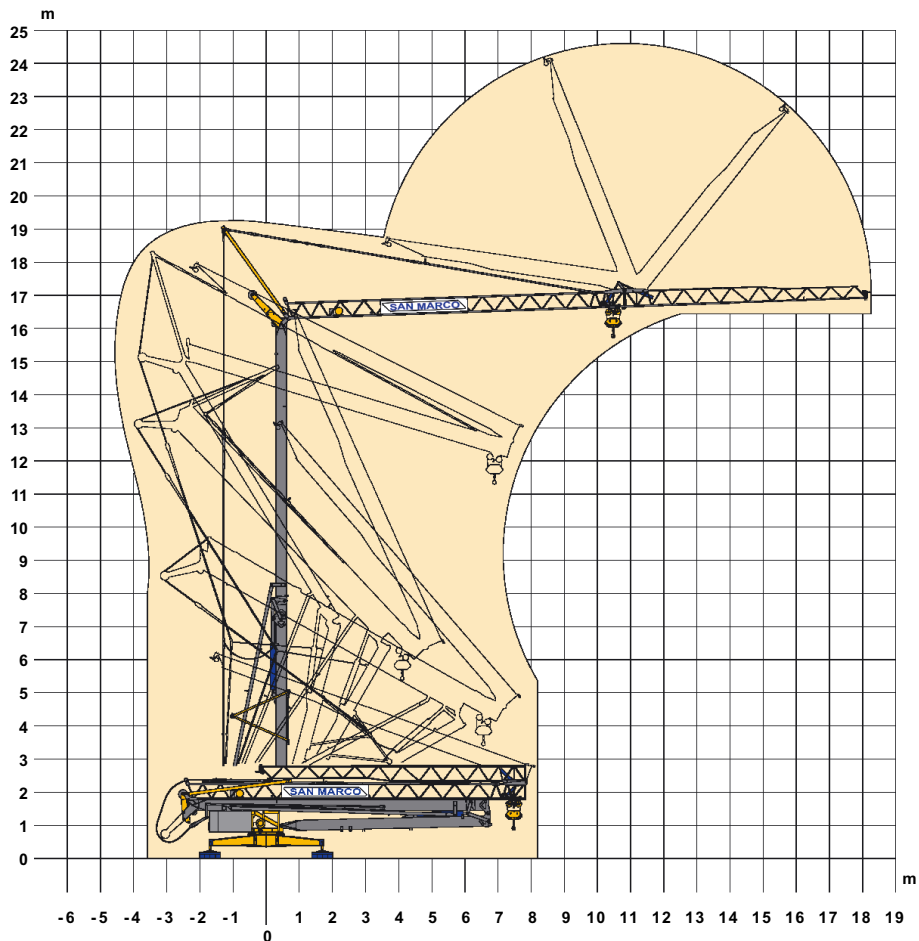



Freccia chiusa  
Closed jib  
Auslegerspitze zu  
Flecha plegada  
Flèche fermée



Kg	10.00 m
1000	

 Diagrammi di carico

 Loads diagrams

 Lastkurven

 Curvas de carga

 Courbes de charges

Braccio impennato  
Inclined jib  
Schrägestellter ausleger  
Flecha inclinada  
Flèche relevée



Carrello traslante  
Traversing trolley  
Verfahrbare laufkatze  
Carro distribuidor  
Chariot distributeur

Kg	18
1200	8.36 m
1100	9.03 m
1000	9.83 m
900	10.80 m
800	12.00 m
700	13.51 m
600	15.50 m





Braccio orizzontale  
Horizontal jib  
Waagerechter ausleger  
Flecha horizontal  
Flèche horizontale



Kg	18
1200	9.66 m
1100	10.44 m
1000	11.38 m
900	12.50 m
800	13.90 m
700	15.70 m
600	18.00 m

# SMH 184

## Triverter 444

-  Reazioni (F) - Pesì (P)
-  Reactions (F) - Loads (P)
-  Eckdrücke (F) - Krangewicht (P)
-  Reacciones (F) - Pesos (P)
-  Réactions (F) - Poids (P)

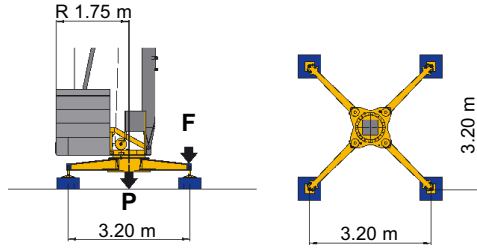





F	P
7.1 t	13.6 t

In servizio - In service - In betrieb - En servicio - En service

F	P
4.2 t	12.3 t

Fuori servizio - Out of service - Ausser betrieb - Fuera de servicio - Hors service





-  Alimentazione elettrica e potenza elettrica necessaria
-  Mains supply and power requirement
-  Netzstrom und anschlusswert
-  Alimentación eléctrica y potencia eléctrica necesaria
-  Réseau électrique et puissance électrique nécessaire

Variatore (Inverter)  
Speed controller  
Unrichter  
Variador  
Variateur

Senza variatore (Inverter) \*  
Without speed controller \*  
Ohne unrichter \*  
Sin variador \*  
Sans variateur \*

	T	M
V	380 (±5%)	220 (±5%)
Hz	50	50
kW	5	3-6

	T *	M *
V	380 (±5%)	220 (±5%)
Hz	50	50
kW	5	3-6

-  Carrello
-  Trolley
-  Katzfahren
-  Carro
-  Chariot

Variatore (Inverter)  
Speed controller  
Unrichter  
Variador  
Variateur

				
m/min	7	14	21	28
kW	0.75			

Senza variatore (Inverter) \*  
Without speed controller \*  
Ohne unrichter \*  
Sin variador \*  
Sans variateur \*

	T *	M *
		
m/min	28	
kW	0.75	





-  Sollevamento
-  Hoisting
-  Heben
-  Elevación
-  Levage

Variatore (Inverter)  
Speed controller  
Unrichter  
Variador  
Variateur

	T				M			
								
m/min	6.5	13	18.5	26	6.5	13	18.5	22
kg	1200	1200	800	600	1200	1200	800	600
kW	4				4			

Senza variatore (Inverter) \*  
Without speed controller \*  
Ohne unrichter \*  
Sin variador \*  
Sans variateur \*

	T *			M *	
					
m/min	6	12	24	11	22
kg	1200	1200	600	1000	500
kW	1.5	2.2	3.0	1.7	1.7

-  Rotazione - Variatore (Inverter)
-  Slewing - Speed controller
-  Schwenken - Unrichter
-  Orientación - Variador
-  Orientation - Variateur

				
rpm	0.25	0.5	0.75	0.9
kW	1.1			

\* A richiesta  
On request  
Auf Wunsch  
Sobre demanda  
Sur demande

**M** Monofase  
Single-phase  
Einphasig  
Monofasica  
Monophase

**T** Trifase  
3phase  
Dreiphasig  
Trifasica  
Triphase

 Media/grande velocità carrello  
Medium/major trolley speed  
Mittel/große katzgeschwindigkeit  
Velocidad media/gran velocidad carro  
Moyenne/grande vitesse chariot

 Lontano sbraccio (sx) - vicino sbraccio (dx)  
Distant jib (sx) - near jib (dx)  
Ausladung fern (sx) - ausladung nah (dx)  
Carro punta (sx) - carro torre (dx)  
Flèche lointain (sx) - flèche proche (dx)

 Rotazione sinistra (sx) - rotazione destra (dx)  
Left rotation (sx) - right rotation (dx)  
Drehung links (sx) - drehung rechts (dx)  
Giro izquierda (sx) - giro derecha (dx)  
Orientation gauche (sx) - orientation droite (dx)

 Salita sollevamento (sx) - discesa sollevamento (dx)  
Load block up (sx) - load block down (dx)  
Heben hebevorgang (sx) - senken hebevorgang (dx)  
Subida de gancho (sx) - bajada de gancho (dx)  
Montée levage (sx) - descente levage (dx)

 Media/grande velocità rotazione  
Medium/major rotation speed  
Mittel/große drehgeschwindigkeit  
Velocidad media/gran velocidad giro  
Moyenne/grande vitesse orientation

 Media/grande velocità sollevamento  
Medium/major hoisting speed  
Mittel/große hubgeschwindigkeit  
Velocidad media/gran velocidad elevacion  
Moyenne/grande vitesse orientation

P1 980 kg	P2 3970 kg
P1 + P2 4950 kg	

Con assali senza zavorra di montaggio  
With axles without ballast  
Mit transportachse ohne montiert Ballast  
Con ejes sin contrapeso de montaje  
Avec essieux sans lest de montage

- Trasporto
- Transportation
- Transport
- Transporte
- Transport

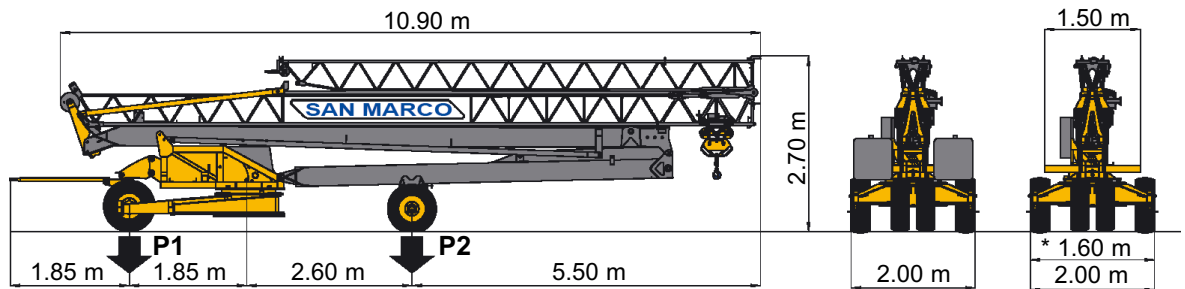

- Assali sterzanti - spostamento laterale (a richiesta) \*
- Steering axles - lateral displacement (on request) \*
- Steuerbare achsen - seitenzustellung (auf wunsch) \*
- Eje direccional - desplazamiento lateral (sobre demanda) \*
- Essieux pivotants - déplacement lateral (sur demande) \*



\* A richiesta  
On request  
Auf Wunsch  
Sobre demanda  
Sur demande

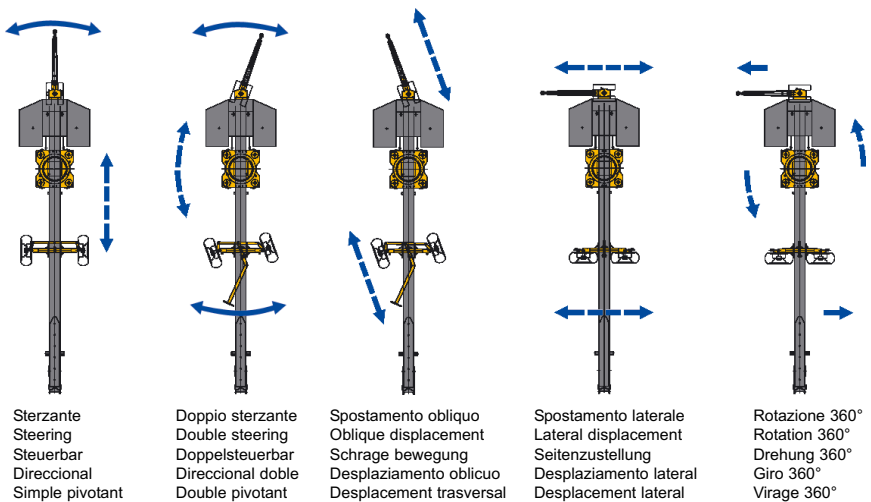

Strutture in acciaio ad alta resistenza per impiego a basse temperature • Zincatura torre e braccio con immersione a caldo secondo ISO 1461 • Bassa emissione acustica e livello di potenza sonora garantito e certificato • Possibilità di funzionamento a braccio impennato e carrello traslante • Climatizzazione termostatica dell'equipaggiamento elettrico per alte e basse temperature • Dispositivi di autolivellamento e autozavorramento

High resilience steel structures to be used at low temperature • Galvanised tower and jib with hot dipping in conformity ISO 1461 • Guaranteed and certified low acoustics emission and sound powers level • Possibility to work with inclined jib and traversing trolley • Automatic temperature control of electrical equipment for high and low temperatures • Full automatic devices for self levelling and ballast loader.

Strukturen aus besonders schlagfesten Stahl für den Einsatz bei niedrigen Temperaturen • Turm und Ausleger lt. ISO 1461 heißverzinkt • Niedriger Geräuschpegel und Schalleistungsniveau garantiert und zertifiziert • Möglichkeit mit schräggestellten Ausleger und Laufkatze bei Abwinkelung zu arbeiten • Thermostatgesteuerte Klimatisierung der elektrischen Ausrüstung für hohe und niedrige Temperaturen • Vorrichtungen zur Selbstnivellierung und Selbstballastierung.

Estructura en acero de alta resistencia para uso a bajas temperaturas • Zincado en caliente de la torre y flecha según normativa ISO 1461 • Baja emisión acústica y nivel de potencia sonora garantizada y certificada • Posibilidad de trabajar con flecha inclinada con carro desplazable a lo largo de toda la flecha • Climatización termostática del equipamiento eléctrico para bajas y altas temperaturas • Dispositivos de autonivelamiento y auto cargado del lastre.

Charpente en acier à haute résilience pour utilisation en température ambiante froide • Galvanisation à chaud mat et flèche par immersion selon ISO 1461 • Émission acoustique réduite et niveau de puissance sonore garantie avec certificat • Possibilité de travailler avec flèche relevée et chariot distributeur • Climatisation thermostatique de l'équipement électrique pour températures ambiante élevées ou basses • Dispositifs automatiques de mise à niveau et de lestage.

Conforme alle direttive CEE: 89/392; 91/368; 93/44; 93/68 e 98/37 direttiva macchine • Conforme alle direttive CEE: 2000/14 e 87/405 livello acustico • Conforme alle direttive CEE: 89/336 compatibilità magnetica • Conforme alle direttive CEE: 73/23 bassa tensione • Conforme al D.P.R. 27/4/55 n. 547 • Le nostre macchine sono protette da assicurazione per responsabilità civile prodotti senza termine • Specifiche suscettibili di variazioni senza preavviso.

In compliance with the EEC 89/392; 91/368; 93/44; 93/68 and 98/37 regulations • In compliance with the EEC 2000/14 and 87/405 regulations on noise levels • In compliance with the EEC 89/336 regulations on electromagnetic compatibility • In compliance with the EEC 73/23 regulations on electrical equipment • Machine covered by lifetime public liability insurance coverage • Specifications subject to modification without notice.

Gemäss EWG Richtlinien 89/392; 91/368; 93/44; 93/68 und 98/37 • Gemäss EWG Richtlinien 2000/14 und 87/405 über schall-leistungspegel • Gemäss EWG Richtlinie 89/336 über Elektromagnetische Verträglichkeit • Gemäss EWG Richtlinie 73/23 über Elektrische Ausrüstung • Maschine unter Produkt-Haftpflichtversicherungsschutz ohne Fristangabe • Obiges kann ohne Berstaendigung geaendert werden.

Conforme con las directivas CEE 89/392; 91/368; 93/44; 93/68 y 98/37 • Conforme con las directivas CEE 2000/14 y 87/405 sobre el nivel acustico • Conforme con la directiva CEE 89/336 sobre la compatibilidad magnetica • Conforme con la directiva CEE 73/23 sobre baja tension • Máquina protegida y asegurada por la responsabilidad civil de productos todo riesgo • Especificaciones sujetas a modificaciones sin previo aviso.

Conforme à les directives CEE 89/392; 91/368; 93/44; 93/68 et 98/37 • Conforme à les directives CEE 2000/14 et 87/405 sur le niveau acoustique • Conforme à la directive CEE 89/336 sur la compatibilité électromagnétique • Conforme à la directive CEE 73/23 sur l'équipement électrique • Machines assurées pour la responsabilité civile des produit sans échéance • Specifications susceptibles de modification sans avis préalable.

Timbro rivenditore • Reseller stamp • Einzelhändlerstempel • Estampilla del minorista • Timbre de détaillant

