

## Worldwide offices

**International** **TADANO LTD.**  
International Division  
4-12, Kamezawa 2-chome  
Sumida-Ku, Tokyo 130-0014, Japan  
Phone: +81-3-3621-7750  
Fax: +81-3-3621-7785  
E-mail: tdnihq@tadano.co.jp

**TADANO AMERICA CORPORATION**  
4242 West Greens Road  
Houston, TX 77066, USA  
Phone: +1-281-869-0030  
Fax: +1-281-869-0040  
E-mail: sales@tadano-cranes.com

**TADANO LTD. Middle East Representative Office**  
P.O.Box 18302, LOB15-323  
Jebel Ali Free Zone, Dubai, UAE  
Phone: +971-4-887-1353  
Fax: +971-4-887-1703  
E-mail: tadano@tadano.ae

**TADANO LTD. Beijing Office**  
Jing Guang Centre, Room 2905, Hu Jia Lou  
Chao Yang Qu  
Beijing, China  
Phone: +86-10-6597-3210  
Fax: +86-10-6597-3220  
E-mail: beijing@tadano.co.jp

**Europe** **TADANO FAUN GmbH**  
Faunberg 2  
91207 Lauf a. d. Pegnitz  
Germany  
Phone: +49-9123-955-0  
Fax: +49-9123-3085  
E-mail: info@tadanofaun.de

**TADANO SOUTH CHINA CO. LTD.**  
Room 1803, 18/F Seaview Commercial  
Building 21-24 Connaught Road West  
Hong Kong, China  
Phone: +852-2544-9310  
Fax: +852-2541-5828  
E-mail: hiwa@tadanosc.com

**TADANO Korea Co Ltd.**  
302, Koram Venture Town B/D  
907-1 Daechi-Dong, Gangnam-Ku  
Seoul 135-280, Korea  
Phone: +82-2-714-1600  
Fax: +82-2-3274-1304  
E-mail: tadano@korea.com

**TADANO Asia Pte Ltd.**  
11 Tuas View Crescent  
Multico Building  
Singapore 637643  
Phone: +65-6863-6901  
Fax: +65-6863-6902  
E-mail: Tdn-crane@tadanoasia.com

**TAIWAN TADANO LTD.**  
4F, No.50, Sung Chiang Road  
Taipei  
Taiwan  
Phone: +886-2-2523-1388  
Fax: +886-2-2523-3988  
E-mail: tadano@ms18.hinet.net

**TADANO FAUN HOLLAND B.V.**  
Antennestraat 6  
3903 LZ Veenendaal  
The Netherlands  
Phone: +31-318-546-700  
Fax: +31-318-542-282  
E-mail: info@tadano-faun.nl

Detaillierte Informationen über unsere Internationalen Händler und Service Niederlassungen finden Sie im Internet.  
For detailed information about our International Distributor and Service network, please refer to our homepages.

[www.tadano.co.jp](http://www.tadano.co.jp) + [www.tadanofaun.de](http://www.tadanofaun.de) + [www.tadanoamerica.com](http://www.tadanoamerica.com)

Herausgeber / Publisher:

**TADANO FAUN GmbH**  
P.O.Box 10 02 64  
91205 Lauf  
Germany



# ALL-TERRAIN ATF 160G-5

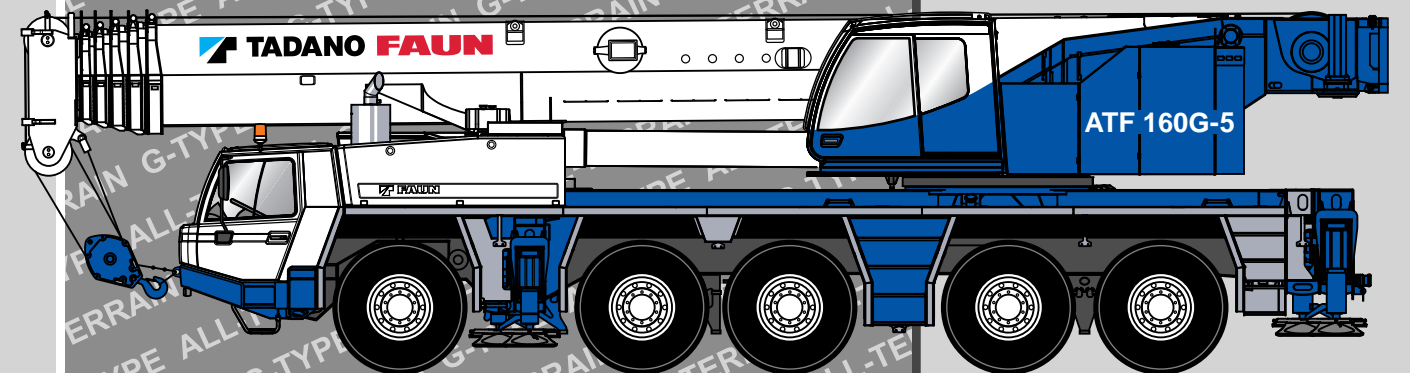

Maße (mm)  
 Dimensions (mm)  
 Dimensiones (mm)

**16.00 R 25**  
 (445/95 R 25)

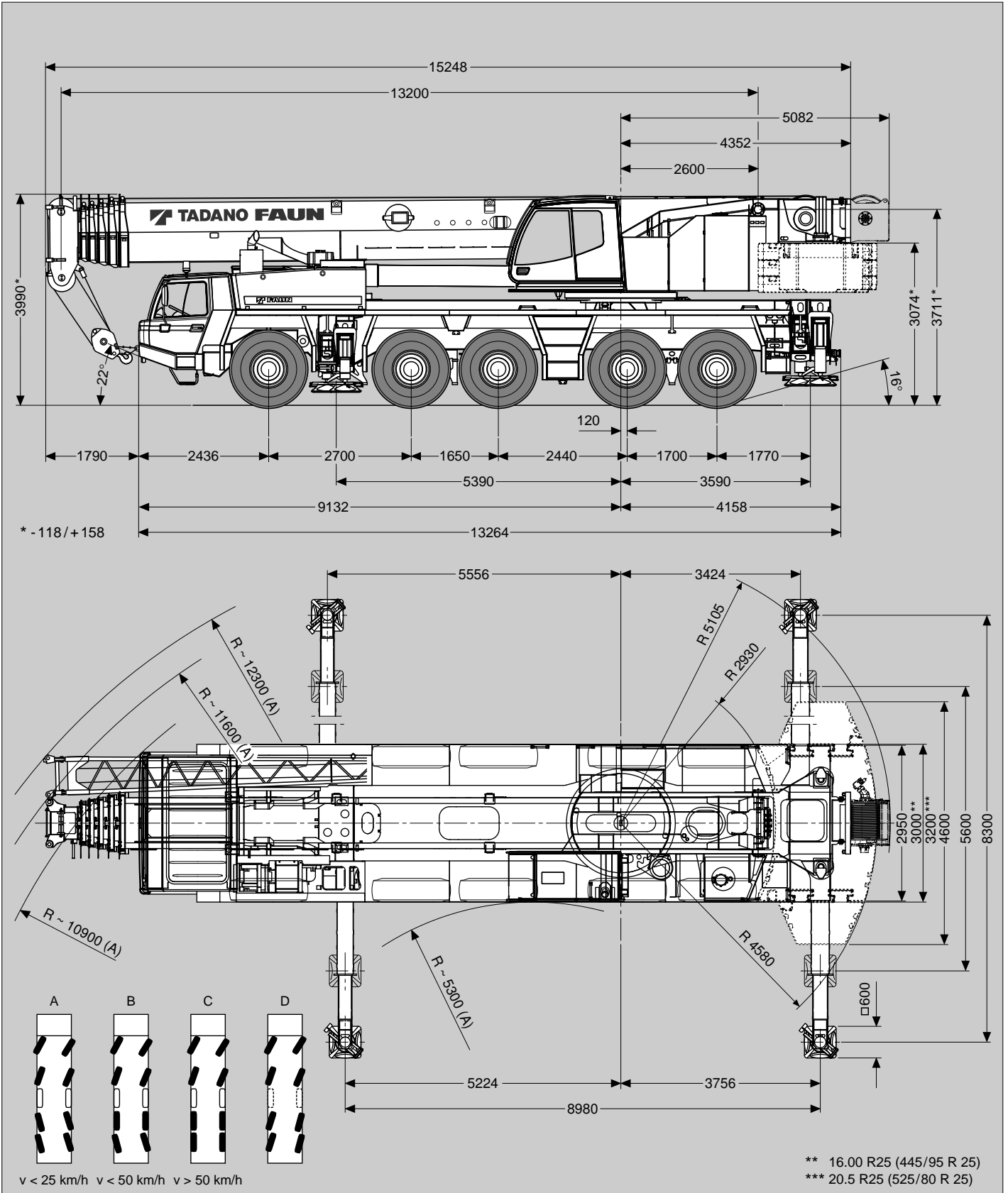

Gewichte / Geschwindigkeiten  
Weights / Working speeds  
Poids / Vitesses  
Pesos / Velocidades de trabajo

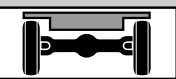
	Achse / Axle Essieu / Eje	1	2	3	4	5	Gesamtgewicht / Total weight Poids total / Peso total
	(t)	12	12	12	12	12	60*

\* Incl. 1 t Gegengewicht, 5,4 m / 13,2 m Auslegerverlängerung, 25 t Unterflasche, 10 t Hakengeschirr, Antrieb 10 x 8, Bereifung 16.00 R 25 (445/95 R 25).

\* Incl. 1 t counterweight, 5.4 m / 13.2 m boom extension, 25 t hook block, 10 t swivel hook, drive 10 x 8, tyres 16.00 R 25 (445/95 R 25).

\* Incl. de 1 t contrepoids, 5,4 m / 13,2 m fléchette, 25 t moufle, 10 t élingues, entraînement 10 x 8, pneus 16.00 R 25 (445/95 R 25).

\* Incl. contrapeso de 1 t, 5,4 m / 13,2 m plumin, 25 t gancho, 10 t gancho de bola, tracción 10 x 8, neumáticos 16.00 R 25 (445/95 R 25).

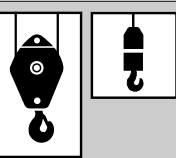
	Traglast / Lifting capacity / Force de levage / Capacidad de elevación	Rollen / Sheaves Pulies / Poleas	Stränge / Parts of line Brins / Ramales de cable	Gewicht / Weight Poid / Peso
	160 t*	9	19	1600 kg
	125 t*	7	15	1200 kg
	80 t*	5	11	800 kg
	63 t*	3	7	600 kg
	63 t	3	7	600 kg
	25 t	1	3	300 kg
10 t	–	1	300 kg	



\* Doppelhaken

\* Rams horn

\* Moufle avec crochet marin

\* Gancho doble

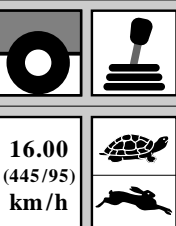







	1	2	3	4	5	6	7	8	9	10	11	12	13	14	15	16	R1	R2		
	3	3	4	4	5	7	8	9	11	14	17	20	24	30	35	42	3	3		> 61%*
	6	7	8	10	12	15	18	21	26	31	38	46	56	68	80	85	6	7		47%

\* Mit Geländeübersetzung

\* Off road range

\* Avec mode tout terrain

\* Con transmisión todo terreno

	<b>Stufenlos</b> Infinitely variable Progressivement variable Infinitamente variable	<b>Seil</b> Rope Câble Cable	<b>Max. Seilzug</b> Max. single line pull Effort maxi au brin simple Trio máximo por ramal
	0 - 130 m/min für einfachen Strang single line au brin simple ramal simple	21 mm / 310 m	85 kN
	0 - 130 m/min für einfachen Strang single line au brin simple ramal simple	21 mm / 250 m	85 kN
	0 - 1.8 min <sup>-1</sup>		
	-1.5° – +84° ca. 50 s approx. 50 s env. 50 s aproximadamente 50 s		
	13.2 m – 60.0 m ca. 400 s approx. 400 s env. 400 s aproximadamente 400 s		

Tragfähigkeiten  
Lifting capacities  
Capacités de levage  
Capacidades de elevación

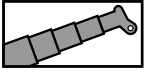

51 t

DIN/ISO

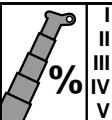
 m	13.2 m*	13.2 m	17.6 m	21.9 m	26.3 m	30.6 m	35.0 m	39.3 m	43.7 m	48.0 m	52.4 m	56.7 m	60.0 m	
3.0	160.0**	140.7**	120.0**	115.6**	89.1									
3.5	149.8**	129.6**	120.0**	115.6**	89.1	74.2								
4.0	138.7**	120.0**	120.0**	115.6**	89.1	73.1								
4.5	129.1**	111.6**	111.8**	111.5**	89.1	68.9	55.1							
5.0	120.5**	101.1	101.3	101.0	89.1	65.1	55.1							
6.0	99.7	88.8	89.0	88.6	89.1	58.6	53.5	41.4	33.4					
7.0	83.9	78.4	78.6	79.0	79.1	53.2	48.7	41.4	33.4	26.9				
8.0	72.1	70.0	70.2	72.0	71.4	48.6	45.1	41.4	33.4	26.9	21.6			
9.0	62.9	62.9	63.1	63.6	63.0	44.7	43.6	38.4	33.4	26.9	21.6	17.0		
10.0	50.6	50.6	55.7	56.8	56.2	41.4	41.6	35.7	32.3	26.9	21.6	17.0	14.0	
11.0			50.6	51.2	50.6	38.6	39.6	33.4	30.3	26.0	21.2	17.0	14.0	
12.0			46.0	46.5	46.0	35.8	37.6	31.2	28.3	25.1	20.9	17.0	14.0	
14.0			38.6	39.1	38.6	32.1	34.2	27.6	25.2	22.9	19.2	16.4	14.0	
16.0				32.2	31.5	29.1	31.3	24.6	22.5	21.0	17.6	15.1	14.0	
18.0				26.6	26.0	26.6	27.9	22.2	20.3	19.0	16.3	14.0	13.0	
20.0					21.8	24.3	23.6	20.1	18.4	17.3	15.1	13.0	12.2	
22.0					20.3	21.0	20.3	18.4	16.8	15.8	14.1	12.2	11.4	
24.0						18.3	17.6	16.9	15.4	14.5	13.2	11.4	10.7	
26.0						16.1	15.4	14.8	14.2	13.3	12.4	10.8	9.9	
28.0							13.6	13.2	12.9	12.3	11.7	10.1	9.0	
30.0							12.0	12.6	11.4	11.4	11.0	9.6	8.3	
32.0								11.4	10.0	10.2	10.2	9.1	7.6	
34.0								10.2	8.9	9.6	9.5	8.6	7.0	
36.0								9.2	8.5	9.0	8.5	8.2	6.5	
38.0									8.2	8.1	7.6	7.9	6.0	
40.0									7.8	7.3	7.3	7.2	5.4	
42.0										6.5	6.9	6.5	5.0	
44.0										6.0	6.3	5.9	4.6	
46.0											5.7	5.3	4.2	
48.0											5.2	4.7	3.9	
50.0												4.2	3.5	
52.0												3.8	3.2	
54.0													2.9	
56.0													2.6	
 %	I	0	0	0	0/0/46/0	0/0/46	0/0/93	0/46/93	0/93/46	0/46/93	0/93/46	46/93	93	100
	II	0	0	0/46	0/0/46/46	0/0/46	0/46/46	0/46/46	0/46/46	46/46/93	93/93/93	93/93	93	100
	III	0	0	0	0/0/0/46	0/46/46	0/46/46	46/46/46	93/46/46	93/46/46	93/93/93	93/93	93	100
	IV	0	0	0	0/46/0/0	46/46/0	93/46/0	93/46/46	93/46/46	93/93/46	93/46/93	93/93	93	100
	V	0	0	46/0	93/46/0/0	93/46/0	93/46/0	93/46/0	93/46/93	93/93/46	93/46/46	93/46	93	100

\* Nach hinten / \* Over rear / \* A l'arrière / \* Sobre la parte trasera

\*\* Mit Zusatzhubausrüstung / \*\* With additional lifting equipment / \*\* Avec équipement supplémentaire / \*\* Con equipo adicional

Hubhöhen  
Lifting heights  
Hauteurs de levage  
Alturas de elevación

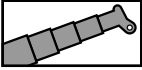

51 t

DIN/ISO

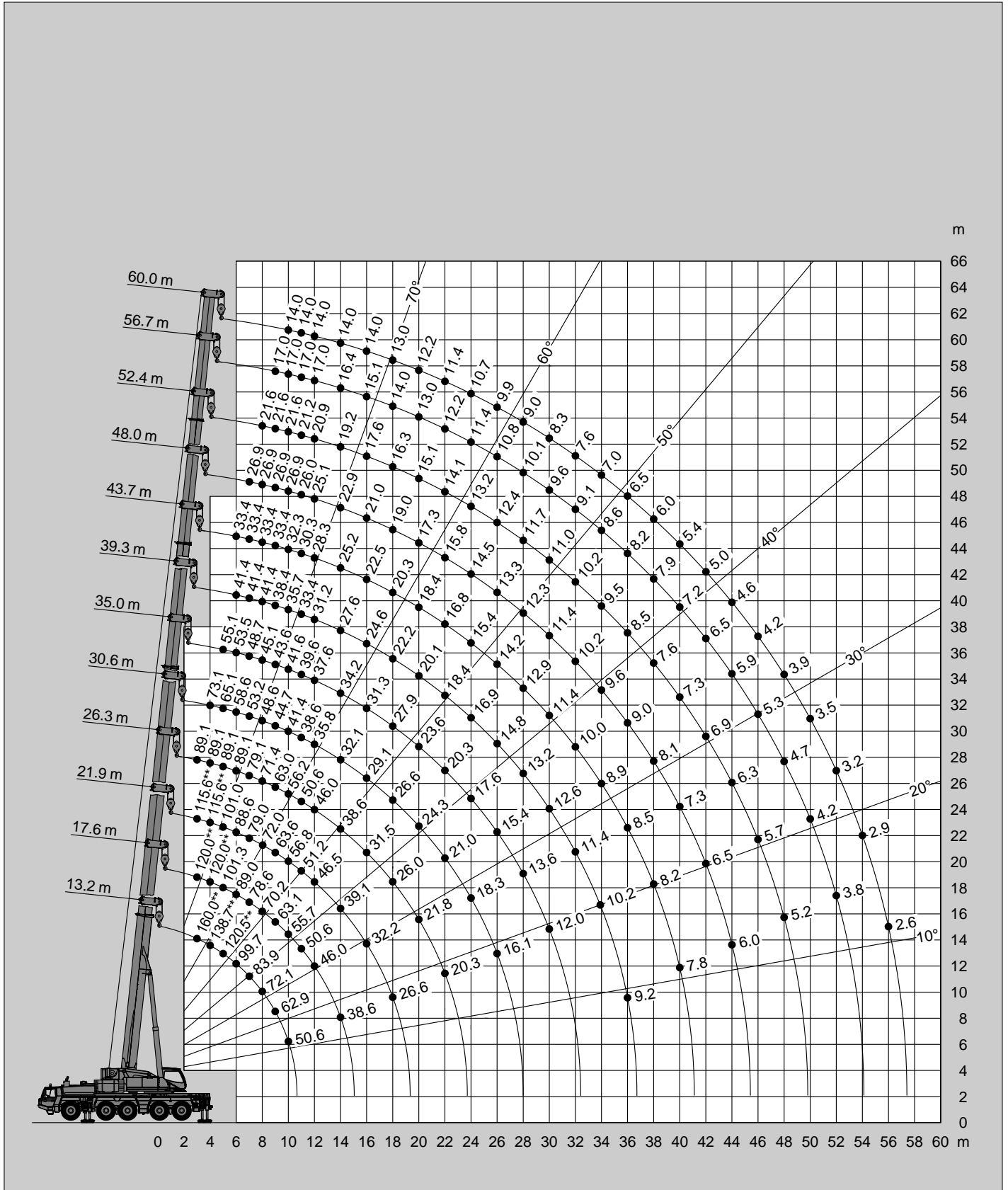

\*\* Mit Zusatzhubausrüstung / \*\* With additional lifting equipment / \*\* Avec équipement supplémentaire / \*\* Con equipo adicional

Tragfähigkeiten  
Lifting capacities  
Capacités de levage  
Capacidades de elevación

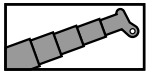

37 t

DIN/ISO

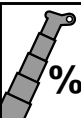
 m	13.2 m*	13.2 m	17.6 m	21.9 m	26.3 m	30.6 m	35.0 m	39.3 m	43.7 m	48.0 m	52.4 m	56.7 m	60.0 m	
3.0	160.0**	140.0**	120.0**	115.6**	89.1									
3.5	149.8**	129.0**	120.0**	115.6**	89.1	74.2								
4.0	132.8**	119.2**	120.0**	115.6**	89.1	73.1								
4.5	121.3**	110.4**	110.8**	111.0**	89.1	68.9	55.1							
5.0	109.2	100.3	100.5	99.8	89.1	65.1	55.1							
6.0	90.7	90.1	89.8	89.4	89.1	58.6	53.5	41.4	33.4					
7.0	77.4	77.0	77.2	77.8	77.1	53.2	48.7	41.4	33.4	26.9				
8.0	67.2	67.0	67.1	67.6	67.0	48.6	45.1	41.4	33.4	26.9	21.6			
9.0	59.3	59.3	59.1	59.7	59.1	44.7	43.6	38.4	33.4	26.9	21.6	17.0		
10.0	50.6	50.6	52.7	53.3	52.7	41.4	41.6	35.7	32.3	26.9	21.6	17.0	14.0	
11.0			47.0	48.0	47.2	38.6	39.6	33.4	30.3	26.0	21.2	17.0	14.0	
12.0			40.8	41.7	40.9	35.8	37.6	31.2	28.3	25.1	20.9	17.0	14.0	
14.0			31.4	32.3	31.6	32.1	33.7	27.6	25.2	22.9	19.2	16.4	14.0	
16.0				25.9	26.1	28.0	27.2	24.6	22.5	21.0	17.6	15.1	14.0	
18.0				21.7	23.5	23.2	22.4	21.7	20.3	19.0	16.3	14.0	13.0	
20.0					19.9	19.6	18.9	18.2	18.1	17.3	15.1	13.0	12.2	
22.0					17.0	16.7	16.0	15.9	15.3	15.5	14.1	12.2	11.4	
24.0						14.4	13.7	14.4	13.0	13.2	13.2	11.4	10.7	
26.0						12.5	11.8	12.5	11.1	12.0	11.8	10.8	9.9	
28.0							10.3	10.9	10.4	10.7	10.2	10.1	9.0	
30.0							9.0	9.6	9.9	9.4	9.4	9.3	8.3	
32.0								8.5	8.8	8.4	8.7	8.2	7.6	
34.0								7.5	7.8	7.9	7.7	7.2	7.0	
36.0								6.6	7.0	7.2	6.8	6.3	6.4	
38.0									6.7	6.4	6.1	5.6	5.6	
40.0									6.1	5.8	5.4	4.9	4.9	
42.0										5.2	4.8	4.3	4.3	
44.0										4.6	4.3	3.8	3.8	
46.0											3.8	3.3	3.3	
48.0											3.3	2.8	2.9	
50.0												2.4	2.5	
52.0												2.1	2.1	
54.0													1.7	
56.0													1.4	
 %	I	0	0	0	0/0/46/0	0/0/46	0/0/93	0/46/93	0/93/46	0/46/93	0/93/46	46/93	93	100
	II	0	0	0/46	0/0/46/46	0/0/46	0/46/46	0/46/46	0/46/46	46/46/93	93/93/93	93/93	93	100
	III	0	0	0	0/0/0/46	0/46/46	0/46/46	46/46/46	93/46/46	93/46/46	93/93/93	93/93	93	100
	IV	0	0	0	0/46/0/0	46/46/0	93/46/0	93/46/46	93/46/46	93/93/46	93/46/93	93/93	93	100
	V	0	0	46/0	93/46/0/0	93/46/0	93/46/0	93/46/0	93/46/93	93/93/46	93/46/46	93/46	93	100

\* Nach hinten / \* Over rear / \* A l'arrière / \* Sobre la parte trasera

\*\* Mit Zusatzhubausrüstung / \*\* With additional lifting equipment / \*\* Avec équipement supplémentaire / \*\* Con equipo adicional

Hubhöhen  
Lifting heights  
Hauteurs de levage  
Alturas de elevación

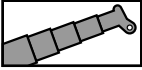

37t

DIN/ISO

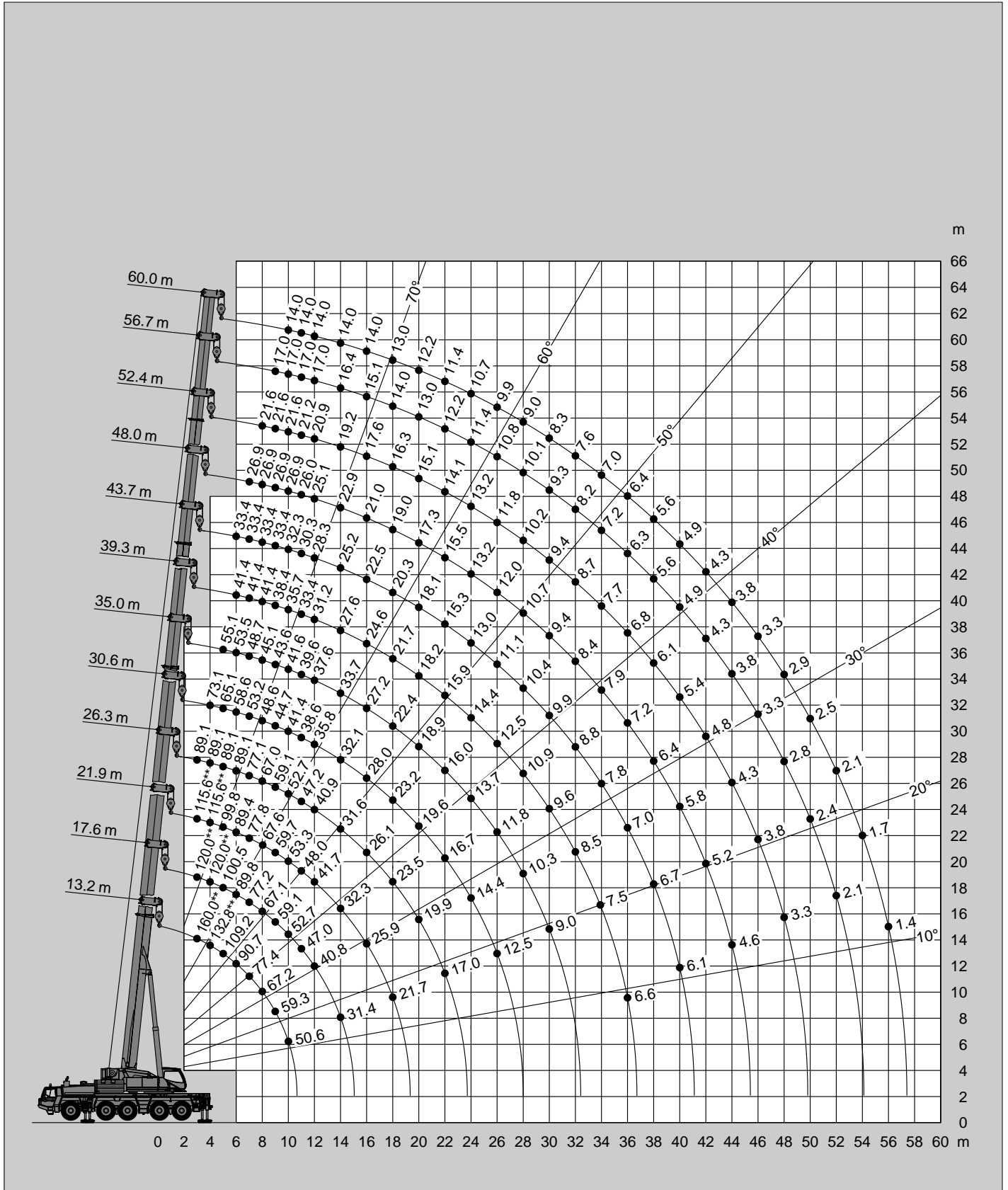

\*\* Mit Zusatzhubausrüstung / \*\* With additional lifting equipment / \*\* Avec équipement supplémentaire / \*\* Con equipo adicional

Tragfähigkeiten  
Lifting capacities  
Capacités de levage  
Capacidades de elevación

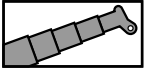

25 t

DIN/ISO

 m	13.2 m*	13.2 m	17.6 m	21.9 m	26.3 m	30.6 m	35.0 m	39.3 m	43.7 m	48.0 m	52.4 m	56.7 m	60.0 m
3.0	160.0**	140.0**	120.0**	115.6**	89.1								
3.5	149.8**	129.0**	120.0**	115.6**	89.1	74.2							
4.0	128.9**	119.2**	120.0**	115.6**	89.1	73.1							
4.5	114.7**	114.0**	114.5**	113.8**	89.1	68.9	55.1						
5.0	103.2	103.2	103.1	102.4	89.1	65.1	55.1						
6.0	85.8	85.8	85.6	86.2	85.5	58.6	53.5	41.4	33.4				
7.0	73.1	73.1	72.9	73.5	72.8	53.2	48.7	41.4	33.4	26.9			
8.0	63.5	63.5	63.3	63.8	63.2	48.6	45.1	41.4	33.4	26.9	21.6		
9.0	54.7	54.7	54.5	55.7	54.8	44.7	43.6	38.4	33.4	26.9	21.6	17.0	
10.0	45.0	45.0	45.0	46.0	45.2	41.4	41.6	35.7	32.3	26.9	21.6	17.0	14.0
11.0			37.9	38.9	38.1	37.7	39.6	33.4	30.3	26.0	21.2	17.0	14.0
12.0			32.7	33.7	32.9	35.6	35.2	31.2	28.3	25.1	20.9	17.0	14.0
14.0			26.0	26.1	28.3	28.0	27.2	26.4	25.2	22.9	19.2	16.4	14.0
16.0				22.5	22.7	22.3	21.6	20.8	20.7	21.0	17.6	15.1	14.0
18.0				18.3	18.5	18.2	17.4	18.2	16.6	16.9	16.3	14.0	13.0
20.0					15.4	15.1	14.4	15.1	13.6	14.8	14.3	13.0	12.2
22.0					13.0	12.7	12.0	12.7	12.6	12.4	12.1	12.2	11.4
24.0						10.8	10.1	10.8	11.2	10.8	11.0	10.5	10.5
26.0						9.2	9.4	9.2	9.6	9.9	9.5	8.9	9.0
28.0							8.9	8.1	8.9	8.5	8.2	7.6	7.7
30.0							8.1	7.6	7.8	7.4	7.1	6.5	6.6
32.0								7.0	6.8	6.5	6.1	5.6	5.6
34.0								6.2	6.0	5.7	5.3	4.8	4.8
36.0								5.4	5.3	4.9	4.6	4.1	4.1
38.0									4.7	4.3	3.9	3.5	3.5
40.0									4.1	3.7	3.4	2.9	2.9
42.0										3.2	2.9	2.4	2.4
44.0										2.8	2.4	2.0	2.0
46.0											2.0	1.6	1.6
48.0											1.7	1.2	1.2

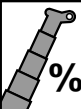
 %	I	II	III	IV	V								
I	0	0	0	0/0/46/0	0/0/46	0/0/93	0/46/93	0/93/46	0/46/93	0/93/46	46/93	93	100
II	0	0	0/46	0/0/46/46	0/0/46	0/46/46	0/46/46	0/46/46	46/46/93	93/93/93	93/93	93	100
III	0	0	0	0/0/0/46	0/46/46	0/46/46	46/46/46	93/46/46	93/46/46	93/93/93	93/93	93	100
IV	0	0	0	0/46/0/0	46/46/0	93/46/0	93/46/46	93/46/46	93/93/46	93/46/93	93/93	93	100
V	0	0	46/0	93/46/0/0	93/46/0	93/46/0	93/46/0	93/46/93	93/93/46	93/46/46	93/46	93	100

\* Nach hinten / \* Over rear / \* A l'arrière / \* Sobre la parte trasera

\*\* Mit Zusatzhubausrüstung / \*\* With additional lifting equipment / \*\* Avec équipement supplémentaire / \*\* Con equipo adicional



Hubhöhen  
Lifting heights  
Hauteurs de levage  
Alturas de elevación

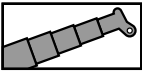

25t

DIN/ISO

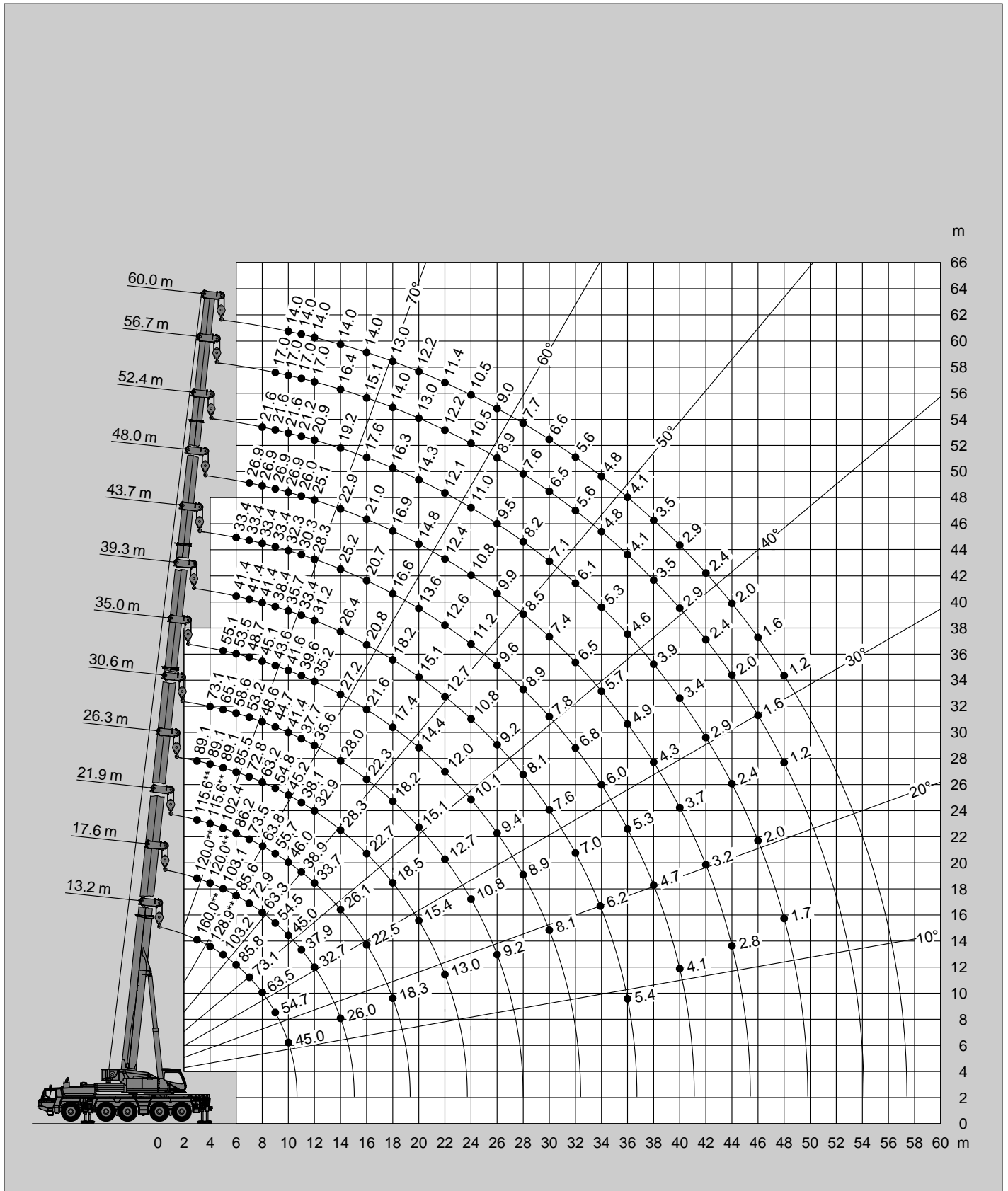

\*\* Mit Zusatzhubausrüstung / \*\* With additional lifting equipment / \*\* Avec équipement supplémentaire / \*\* Con equipo adicional

Tragfähigkeiten  
Lifting capacities  
Capacités de levage  
Capacidades de elevación

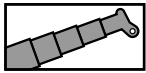

13 t

DIN/ISO

 m	13.2 m*	13.2 m	17.6 m	21.9 m	26.3 m	30.6 m	35.0 m	39.3 m	43.7 m	48.0 m	52.4 m	56.7 m	60.0 m
3.0	160.0**	140.0**	120.0**	115.6**	89.1								
3.5	138.5**	128.6**	120.0**	115.6**	89.1	74.2							
4.0	121.6**	118.7**	120.0**	115.6**	89.1	73.1							
4.5	108.2	108.2	108.0	107.3	89.1	68.9	55.1						
5.0	97.3	97.3	97.1	96.5	89.1	65.1	55.1						
6.0	80.8	80.8	80.6	81.2	80.5	58.6	53.5	41.4	33.4				
7.0	68.8	68.8	68.6	69.2	65.5	53.2	48.7	41.4	33.4	26.9			
8.0	53.4	53.4	53.3	54.6	53.6	48.6	45.1	41.4	33.4	26.9	21.6		
9.0	42.3	42.3	42.2	43.4	42.5	42.2	43.6	38.4	33.4	26.9	21.6	17.0	
10.0	34.5	34.5	34.4	35.5	36.9	38.2	37.2	35.7	32.3	26.9	21.6	17.0	14.0
11.0			29.5	31.2	32.5	32.1	31.1	30.2	30.1	26.0	21.2	17.0	14.0
12.0			26.4	27.7	27.9	27.5	26.6	25.7	25.6	25.1	20.9	17.0	14.0
14.0			19.7	20.9	21.1	20.7	19.9	20.8	19.0	19.3	19.2	16.4	14.0
16.0				16.3	16.5	16.2	15.4	16.2	16.0	15.9	15.3	15.1	14.0
18.0				13.2	14.0	12.9	12.8	13.0	13.4	13.7	13.2	12.6	12.7
20.0					11.6	10.7	11.8	11.2	11.6	11.2	10.8	10.2	10.3
22.0					9.7	9.8	10.0	9.9	9.7	9.3	8.9	8.3	8.4
24.0						8.3	8.5	8.3	8.2	7.8	7.4	6.8	6.9
26.0						7.1	7.2	7.1	6.9	6.5	6.1	5.6	5.6
28.0							6.2	6.0	5.9	5.5	5.1	4.6	4.6
30.0							5.3	5.1	5.0	4.6	4.3	3.7	3.8
32.0								4.4	4.2	3.9	3.5	3.0	3.0
34.0								3.7	3.6	3.2	2.9	2.4	2.4
36.0								3.2	3.0	2.7	2.3	1.8	1.8
38.0									2.5	2.2	1.8	1.3	1.3
40.0									2.1	1.7	1.4		
42.0										1.3			
44.0										1.0			

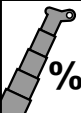

 %	I	II	III	IV	V								
I	0	0	0	0/0/46/0	0/0/46	0/0/93	0/46/93	0/93/46	0/46/93	0/93/46	46/93	93	100
II	0	0	0/46	0/0/46/46	0/0/46	0/46/46	0/46/46	0/46/46	46/46/93	93/93/93	93/93	93	100
III	0	0	0	0/0/0/46	0/46/46	0/46/46	46/46/46	93/46/46	93/46/46	93/93/93	93/93	93	100
IV	0	0	0	0/46/0/0	46/46/0	93/46/0	93/46/46	93/46/46	93/93/46	93/46/93	93/93	93	100
V	0	0	46/0	93/46/0/0	93/46/0	93/46/0	93/46/0	93/46/93	93/93/46	93/46/46	93/46	93	100

\* Nach hinten / \* Over rear / \* A l'arrière / \* Sobre la parte trasera

\*\* Mit Zusatzhubausrüstung / \*\* With additional lifting equipment / \*\* Avec équipement supplémentaire / \*\* Con equipo adicional

Hubhöhen  
Lifting heights  
Hauteurs de levage  
Alturas de elevación

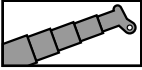

13t

DIN/ISO

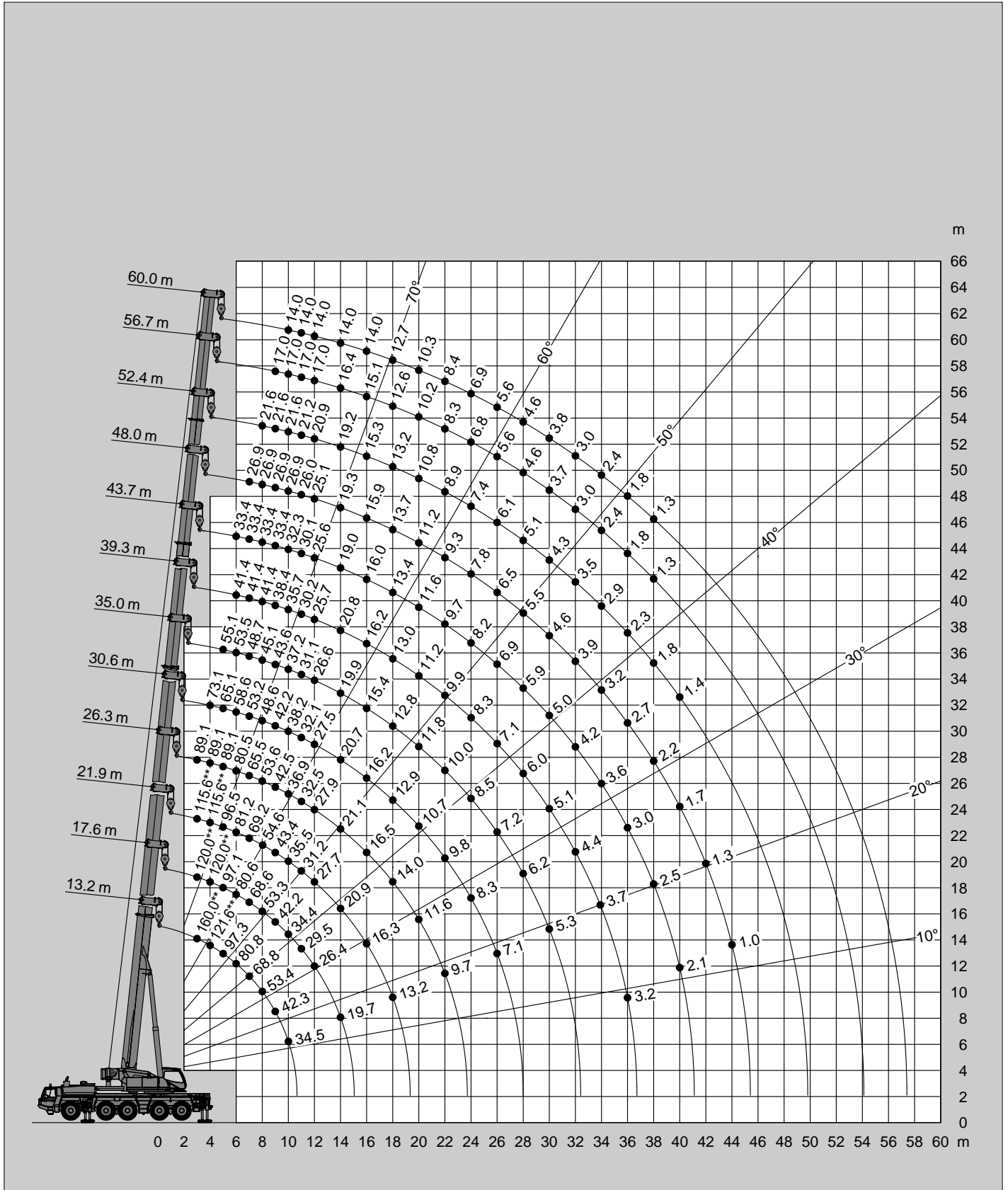

\*\* Mit Zusatzhubausrüstung / \*\* With additional lifting equipment / \*\* Avec équipement supplémentaire / \*\* Con equipo adicional

Tragfähigkeiten  
Lifting capacities  
Capacités de levage  
Capacidades de elevación

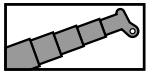

0 t

DIN/ISO

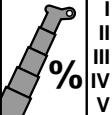
 m	13.2 m*	13.2 m	17.6 m	21.9 m	26.3 m	30.6 m	35.0 m	39.3 m	43.7 m	48.0 m	52.4 m	56.7 m	60.0 m
3.0	150.0**	140.0**	120.0**	115.6**	89.1								
3.5	129.4**	129.4**	120.0**	115.6**	89.1	74.2							
4.0	113.6**	113.6**	113.4**	112.6**	89.1	73.1							
4.5	101.0	101.0	100.8	100.3	89.1	68.9	55.1						
5.0	90.9	90.9	90.7	91.2	89.1	65.1	55.1						
6.0	72.9	72.9	72.8	74.6	73.1	58.6	53.5	41.4	33.4				
7.0	49.9	49.7	49.5	51.0	49.8	48.6	48.7	41.4	29.0	26.9			
8.0	37.1	36.0	35.9	38.4	41.5	40.9	39.6	38.3	24.3	23.0	21.6		
9.0	29.0	27.2	30.1	31.7	32.0	31.5	30.3	29.2	22.9	20.7	18.9	17.0	
10.0	23.2	21.2	24.0	25.4	25.6	25.2	24.1	25.2	21.6	19.0	17.6	16.1	14.0
11.0			19.6	20.9	21.1	20.7	19.7	20.8	20.4	16.6	15.4	14.0	13.6
12.0			16.4	18.2	18.9	17.5	17.4	17.5	18.0	14.6	13.5	12.3	11.9
14.0			11.7	13.0	14.0	14.3	14.4	14.2	14.0	11.5	10.6	9.5	9.3
16.0				9.8	10.7	11.0	11.1	10.9	10.7	9.2	8.4	7.5	7.3
18.0				7.5	8.4	8.6	8.8	8.6	8.4	7.4	6.7	5.8	5.7
20.0					6.6	6.8	7.0	6.8	6.6	6.0	5.4	4.5	4.4
22.0					5.3	5.5	5.6	5.5	5.3	4.9	4.3	3.5	3.4
24.0						4.4	4.5	4.4	4.2	3.8	3.4	2.6	2.5
26.0						3.5	3.6	3.5	3.3	2.9	2.5	1.9	1.8
28.0							2.9	2.7	2.6	2.2	1.8		
30.0							2.3	2.1	2.0	1.6			
32.0								1.6					
 %	I 0	0	0	0/0/46/0	0/0/46	0/0/93	0/46/93	0/93/46	0/46/93	0/93/46	46/93	93	100
	II 0	0	0/46	0/0/46/46	0/0/46	0/46/46	0/46/46	0/46/46	46/46/93	93/93/93	93/93	93	100
	III 0	0	0	0/0/0/46	0/46/46	0/46/46	46/46/46	93/46/46	93/46/46	93/93/93	93/93	93	100
	IV 0	0	0	0/46/0/0	46/46/0	93/46/0	93/46/46	93/46/46	93/93/46	93/46/93	93/93	93	100
	V 0	0	46/0	93/46/0/0	93/46/0	93/46/0	93/46/0	93/46/93	93/93/46	93/46/46	93/46	93	100

\* Nach hinten / \* Over rear / \* A l'arrière / \* Sobre la parte trasera

\*\* Mit Zusatzhubausrüstung / \*\* With additional lifting equipment / \*\* Avec équipement supplémentaire / \*\* Con equipo adicional

Hubhöhen  
Lifting heights  
Hauteurs de levage  
Alturas de elevación

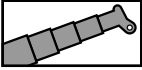

0t

DIN/ISO

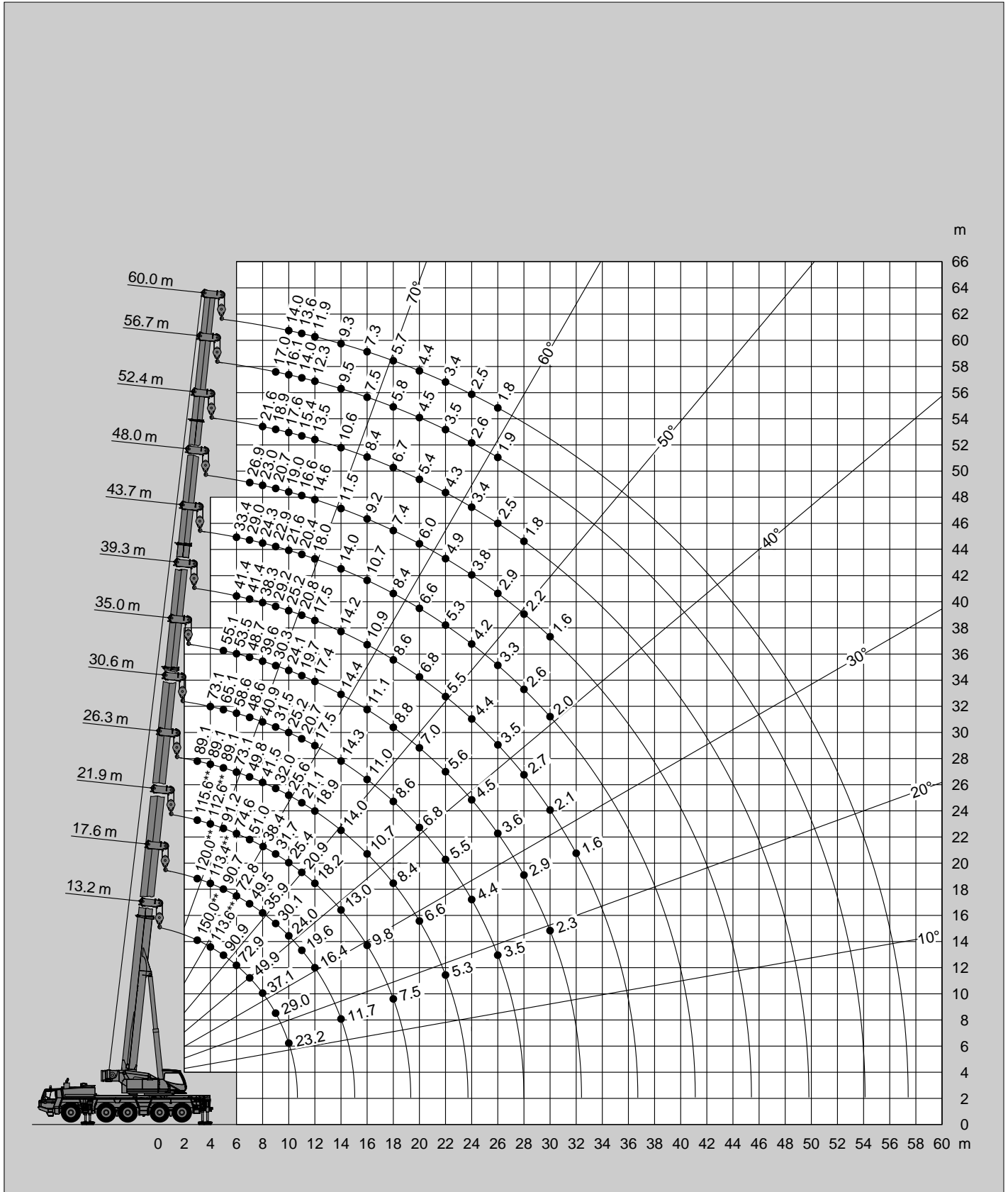

\*\* Mit Zusatzhubausrüstung / \*\* With additional lifting equipment / \*\* Avec équipement supplémentaire / \*\* Con equipo adicional

Tragfähigkeiten  
Lifting capacities  
Capacités de levage  
Capacidades de elevación

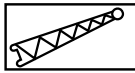
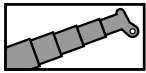

51t

DIN / ISO

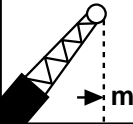
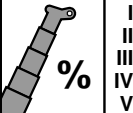
 m	13.2 m + 5.4 m			56.7 m + 5.4 m			60.0 m + 5.4 m		
	0°	20°	40°	0°	20°	40°	0°	20°	40°
3.0	33.2								
3.5	31.4	23.7							
4.0	30.6	22.5							
4.5	29.1	22.2	18.5						
5.0	28.4	21.6	18.2						
6.0	26.0	20.5	17.9						
7.0	24.5	19.8	17.5						
8.0	22.9	19.0	17.2						
9.0	21.6	18.5	16.9						
10.0	20.5	18.0	16.8	10.7					
11.0	19.6	17.5	16.8	10.3			9.6		
12.0	18.8	17.2	16.8	10.0	9.2		9.3	8.6	
14.0	17.5	16.8		9.4	8.7	8.2	8.7	8.1	7.7
16.0	16.8			8.8	8.2	7.8	8.2	7.7	7.3
18.0				8.4	7.8	7.5	7.8	7.3	7.0
20.0				7.9	7.5	7.2	7.4	7.0	6.7
22.0				7.5	7.2	6.9	7.0	6.7	6.4
24.0				7.2	6.9	6.6	6.7	6.4	6.2
26.0				6.8	6.6	6.4	6.4	6.1	6.0
28.0				6.5	6.3	6.2	6.1	5.9	5.8
30.0				6.3	6.0	5.9	5.8	5.6	5.5
32.0				6.0	5.8	5.7	5.6	5.4	5.3
34.0				5.8	5.6	5.5	5.4	5.2	5.1
36.0				5.6	5.4	5.3	5.2	5.0	5.0
38.0				5.4	5.2	5.2	5.0	4.9	4.8
40.0				5.2	5.1	5.0	4.9	4.7	4.7
44.0				4.9	4.8	4.8	4.6	4.5	4.4
48.0				4.7	4.6	4.6	4.3	4.2	4.2
52.0				3.8	3.9		3.8	3.9	3.9
56.0				3.0	2.9		3.0	3.0	
60.0							2.3	2.3	
 %	I	0			93			100	
	II	0			93			100	
	III	0			93			100	
	IV	0			93			100	
	V	0			93			100	

Hubhöhen  
Lifting heights  
Hauteurs de levage  
Alturas de elevación

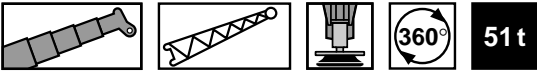

DIN/ISO

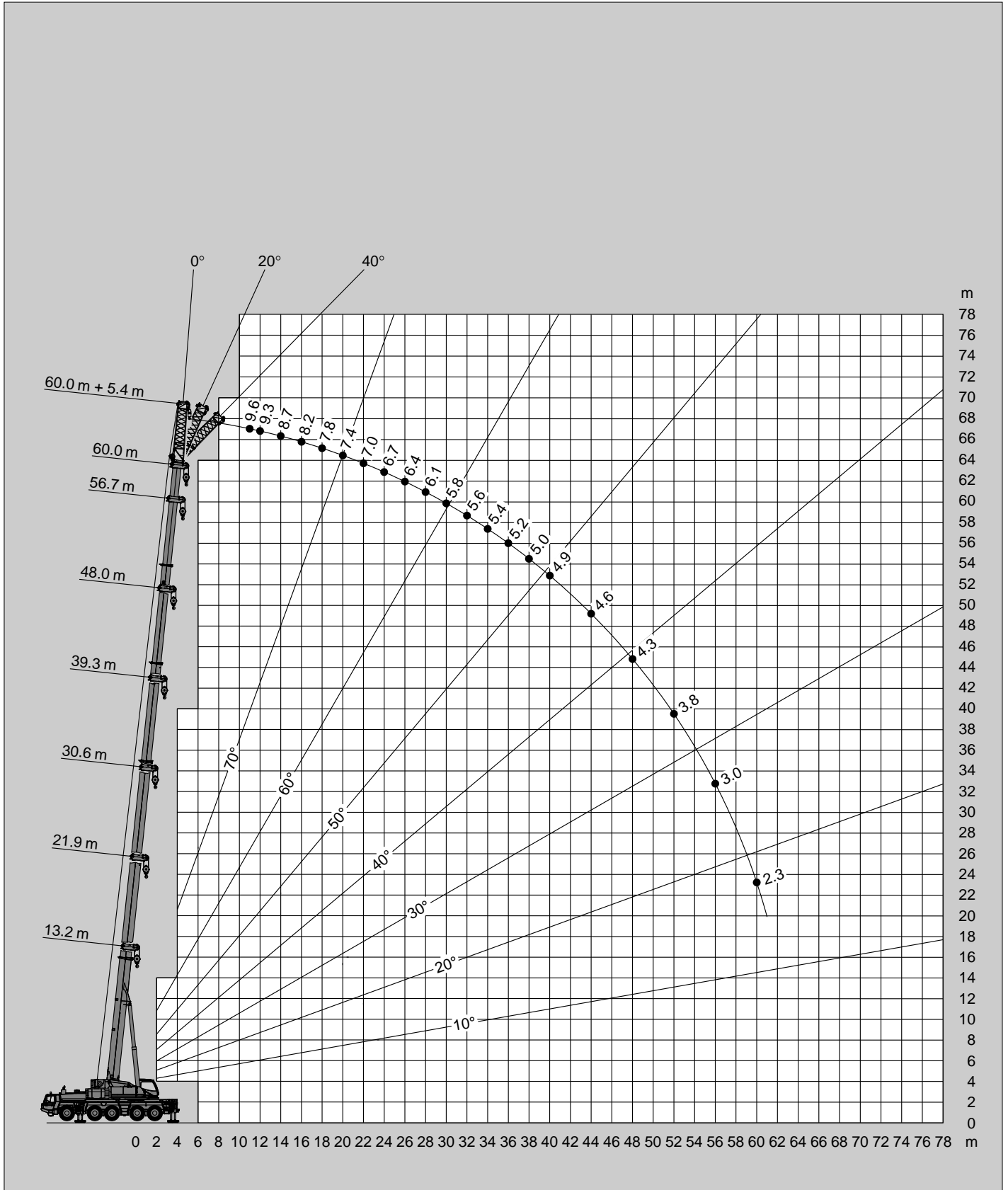

Tragfähigkeiten  
Lifting capacities  
Capacités de levage  
Capacidades de elevación

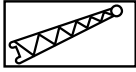
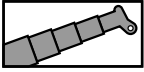

51t

DIN / ISO

m	60.0 m + 13.2 m			60.0 m + 19.2 m			60.0 m + 25.2 m			60.0 m + 31.2 m			60.0 m + 37.2 m		
	0°	20°	40°	0°	20°	40°	0°	20°	40°	0°	20°		0°		
12.0	6.3			4.8											
14.0	6.3			4.8			3.6			2.8					
16.0	6.3			4.8			3.6			2.8			2.1		
18.0	6.3	5.3		4.8			3.6			2.8			2.0		
20.0	6.0	5.2	4.4	4.8	4.4		3.6			2.8			1.9		
22.0	5.7	5.0	4.3	4.8	4.2		3.6			2.7			1.9		
24.0	5.5	4.9	4.2	4.6	4.0		3.6	3.1		2.7			1.8		
26.0	5.2	4.7	4.1	4.4	3.9	3.5	3.6	3.0		2.6			1.8		
28.0	5.0	4.5	4.1	4.2	3.7	3.4	3.6	2.9		2.5	2.0		1.7		
30.0	4.8	4.3	4.0	4.1	3.6	3.3	3.4	2.9	2.5	2.5	2.0		1.7		
32.0	4.6	4.2	3.9	3.9	3.4	3.2	3.3	2.8	2.5	2.4	1.9		1.6		
34.0	4.5	4.1	3.8	3.8	3.3	3.1	3.2	2.7	2.4	2.3	1.9		1.6		
36.0	4.3	3.9	3.7	3.6	3.2	3.0	3.0	2.7	2.4	2.3	1.8		1.5		
38.0	4.1	3.8	3.6	3.5	3.1	2.9	2.9	2.6	2.3	2.2	1.8		1.5		
40.0	4.0	3.7	3.5	3.4	3.0	2.8	2.8	2.5	2.3	2.2	1.8		1.4		
44.0	3.7	3.5	3.4	3.2	2.8	2.7	2.6	2.3	2.2	2.1	1.7		1.4		
48.0	3.5	3.3	3.2	3.0	2.7	2.6	2.5	2.2	2.1	2.0	1.6		1.3		
52.0	3.3	3.1	3.1	2.8	2.6	2.4	2.3	2.1	2.0	1.9	1.5		1.2		
56.0	3.1	3.0	2.9	2.6	2.4	2.3	2.2	2.0	1.9	1.8	1.4		1.2		
60.0	2.7	2.9	2.8	2.5	2.3	2.3	2.1	1.9	1.8	1.7	1.4		1.1		
64.0	2.1	2.2	2.1	2.3	2.2	2.2	1.9	1.7	1.7	1.6	1.3		1.1		
68.0	1.6	1.6	1.3	1.8	1.9	1.9	1.7	1.5	1.6	1.5	1.2		1.0		
72.0				1.3	1.3	1.2	1.4	1.3	1.5	1.4	1.2				
76.0							1.0	1.1	1.0	1.1	1.1				

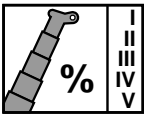

I	100			100			100			100			100		
II	100			100			100			100			100		
III	100			100			100			100			100		
IV	100			100			100			100			100		
V	100			100			100			100			100		

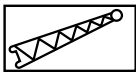
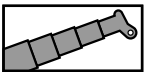

51t

DIN / ISO

m	56.7 m + 13.2 m			56.7 m + 19.2 m			56.7 m + 25.2 m			56.7 m + 31.2 m			56.7 m + 37.2 m		
	0°	20°	40°	0°	20°	40°	0°	20°	40°	0°	20°	40°	0°	20°	
11.0	7.5														
12.0	7.5			5.6			4.2								
14.0	7.5			5.6			4.2			3.2					
16.0	7.1	5.6		5.6			4.2			3.1			2.2		
18.0	6.7	5.4		5.6			4.2			3.0			2.1		
20.0	6.4	5.2	4.4	5.4	4.6		4.2			2.9			2.0		
22.0	6.1	5.1	4.3	5.1	4.4		4.0			2.9			2.0		
24.0	5.8	4.9	4.2	4.9	4.2		3.9	3.2		2.8			1.9		
26.0	5.6	4.8	4.2	4.7	4.1	3.7	3.8	3.1		2.7			1.9		
28.0	5.3	4.7	4.1	4.5	3.9	3.6	3.7	3.0		2.6	2.1		1.8		
30.0	5.1	4.5	4.0	4.3	3.8	3.5	3.6	2.9	2.5	2.6	2.0		1.7		
32.0	4.9	4.4	4.0	4.1	3.6	3.4	3.5	2.9	2.5	2.5	2.0		1.7	1.3	
34.0	4.7	4.3	3.9	4.0	3.5	3.2	3.3	2.8	2.4	2.4	1.9		1.6	1.3	
36.0	4.6	4.1	3.8	3.8	3.4	3.2	3.2	2.7	2.4	2.3	1.9	1.7	1.6	1.2	
38.0	4.4	4.0	3.8	3.7	3.3	3.1	3.1	2.7	2.3	2.3	1.8	1.6	1.5	1.2	
40.0	4.2	3.9	3.7	3.6	3.2	3.0	3.0	2.6	2.3	2.2	1.8	1.6	1.5	1.1	
44.0	4.0	3.7	3.6	3.3	3.0	2.8	2.8	2.4	2.2	2.1	1.7	1.5	1.4	1.1	
48.0	3.7	3.5	3.4	3.2	2.8	2.7	2.6	2.3	2.1	2.0	1.6	1.5	1.3	1.0	
52.0	3.5	3.4	3.3	3.0	2.7	2.6	2.4	2.2	2.1	1.9	1.6	1.4	1.2	1.0	
56.0	3.4	3.2	3.2	2.8	2.6	2.5	2.3	2.1	2.0	1.8	1.5	1.4	1.1		
60.0	2.8	2.9	2.8	2.7	2.5	2.4	2.2	2.0	1.9	1.7	1.4	1.3	1.1		
64.0	2.2	2.2	2.0	2.4	2.4	2.4	2.1	1.9	1.8	1.6	1.4	1.3	1.0		
68.0				1.9	1.9	1.8	2.0	1.8	1.8	1.6	1.3	1.3	1.0		
72.0				1.4	1.3		1.5	1.7	1.5	1.5	1.3	1.3			
76.0							1.1	1.1		1.2	1.3	1.3			

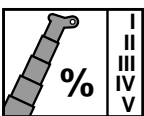

I	93			93			93			93			93		
II	93			93			93			93			93		
III	93			93			93			93			93		
IV	93			93			93			93			93		
V	93			93			93			93			93		



Hubhöhen  
Lifting heights  
Hauteurs de levage  
Alturas de elevación

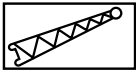
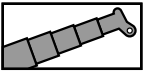

51 t

DIN/ISO

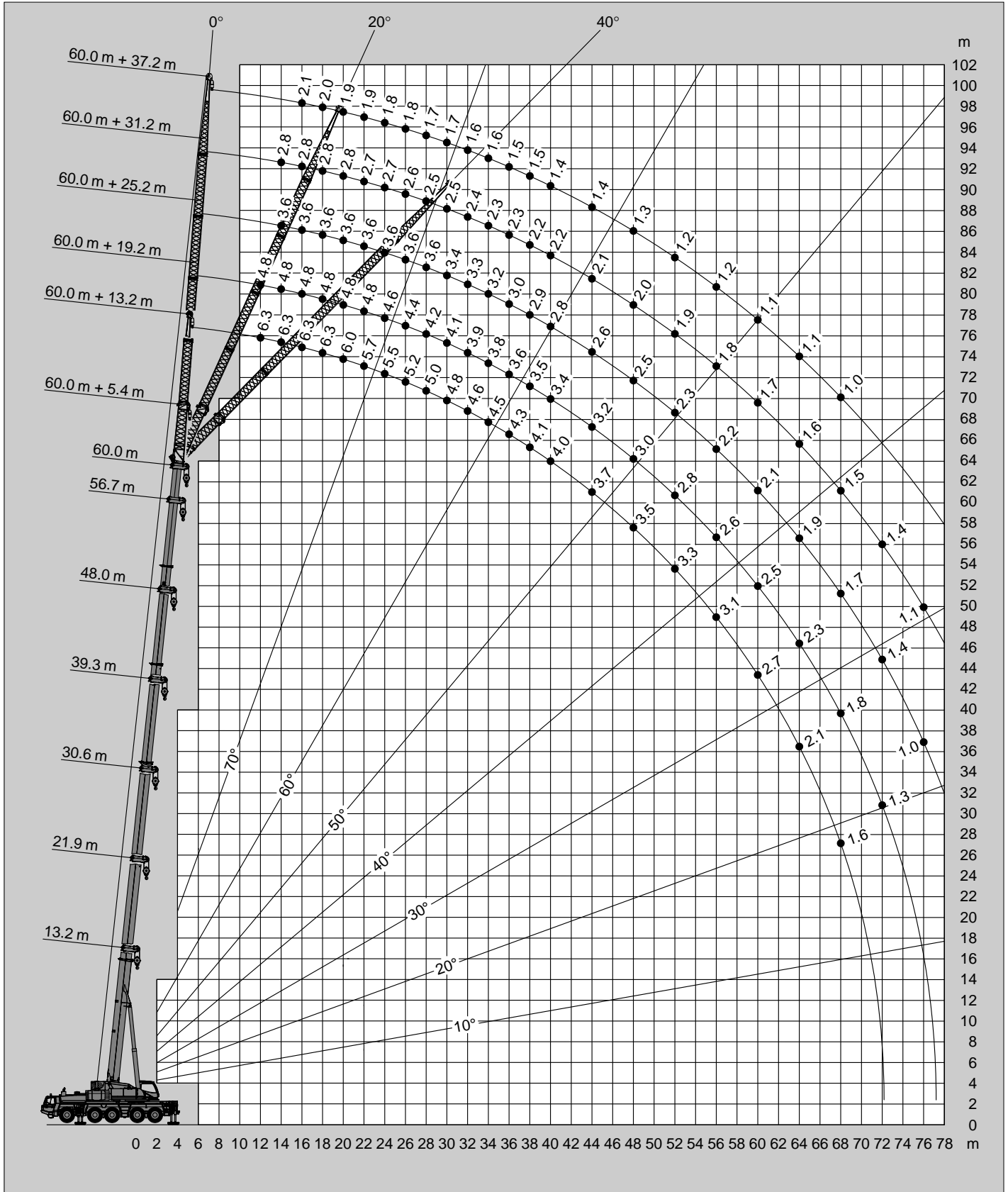

Tragfähigkeiten  
Lifting capacities  
Capacités de levage  
Capacidades de elevación

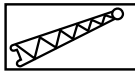
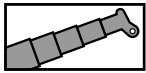

37t

DIN / ISO

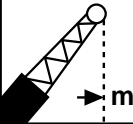
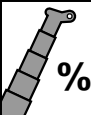
 m	13.2 m + 5.4 m			56.7 m + 5.4 m			60.0 m + 5.4 m		
	0°	20°	40°	0°	20°	40°	0°	20°	40°
3.0	33.2								
3.5	31.4	23.7							
4.0	30.6	22.5							
4.5	29.1	22.2	18.5						
5.0	28.4	21.6	18.2						
6.0	26.0	20.5	17.9						
7.0	24.5	19.8	17.5						
8.0	22.9	19.0	17.2						
9.0	21.6	18.5	16.9						
10.0	20.5	18.0	16.8	10.7					
11.0	19.6	17.5	16.8	10.3			9.6		
12.0	18.8	17.2	16.8	10.0	9.2		9.3	8.6	
14.0	17.5	16.8		9.4	8.7	8.2	8.7	8.1	7.7
16.0	16.8			8.8	8.2	7.8	8.2	7.7	7.3
18.0				8.4	7.8	7.5	7.8	7.3	7.0
20.0				7.9	7.5	7.2	7.4	7.0	6.7
22.0				7.5	7.2	6.9	7.0	6.7	6.4
24.0				7.2	6.9	6.6	6.7	6.4	6.2
26.0				6.8	6.6	6.4	6.4	6.1	6.0
28.0				6.5	6.3	6.2	6.1	5.9	5.8
30.0				6.3	6.0	5.9	5.8	5.6	5.5
32.0				6.0	5.8	5.7	5.6	5.4	5.3
34.0				5.8	5.6	5.5	5.4	5.2	5.1
36.0				5.6	5.4	5.3	5.2	5.0	5.0
38.0				5.4	5.2	5.2	5.0	4.9	4.8
40.0				5.0	5.1	5.0	4.9	4.7	4.7
44.0				3.8	3.9	4.0	3.8	3.9	4.0
48.0				2.9	3.0	3.0	2.8	3.0	3.0
52.0				2.1	2.1		2.1	2.1	2.1
56.0				1.4	1.4		1.4	1.4	
 %	I	0			93			100	
	II	0			93			100	
	III	0			93			100	
	IV	0			93			100	
	V	0			93			100	

Hubhöhen  
Lifting heights  
Hauteurs de levage  
Alturas de elevación

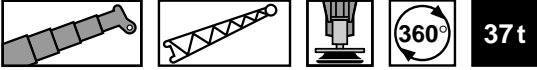

DIN/ISO

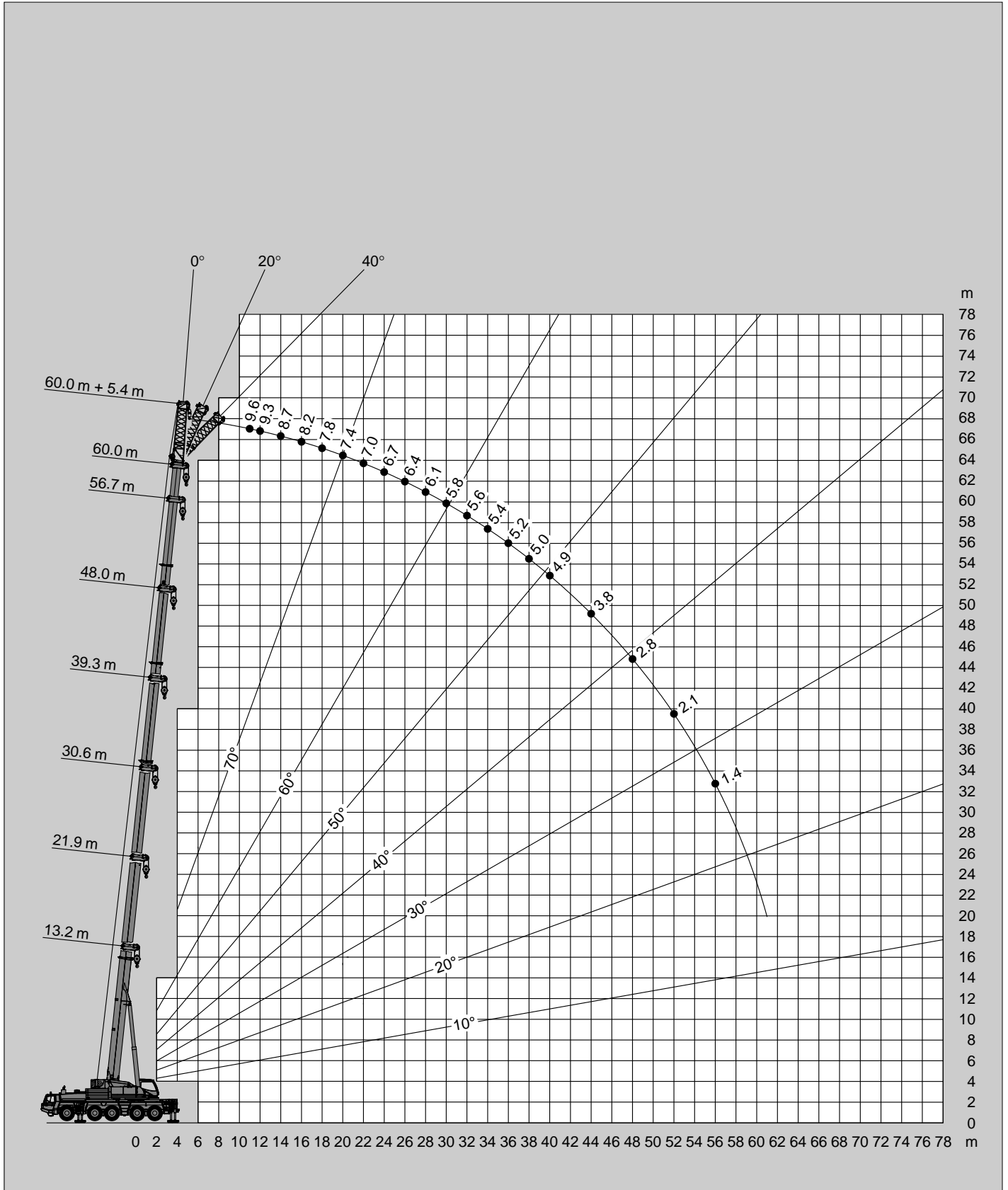

Tragfähigkeiten  
Lifting capacities  
Capacités de levage  
Capacidades de elevación

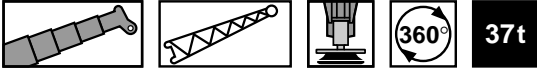

m	60.0 m + 13.2 m			60.0 m + 19.2 m			60.0 m + 25.2 m			60.0 m + 31.2 m			60.0 m + 37.2 m		
	0°	20°	40°	0°	20°	40°	0°	20°	40°	0°	20°		0°		
12.0	6.3			4.8											
14.0	6.3			4.8			3.6				2.8				
16.0	6.3			4.8			3.6				2.8			2.1	
18.0	6.3	5.3		4.8			3.6				2.8			2.0	
20.0	6.0	5.2	4.4	4.8	4.4		3.6				2.8			1.9	
22.0	5.7	5.0	4.3	4.8	4.2		3.6				2.7			1.9	
24.0	5.5	4.9	4.2	4.6	4.0		3.6	3.1			2.7			1.8	
26.0	5.2	4.7	4.1	4.4	3.9	3.5	3.6	3.0			2.6			1.8	
28.0	5.0	4.5	4.1	4.2	3.7	3.4	3.6	2.9			2.5	2.0		1.7	
30.0	4.8	4.3	4.0	4.1	3.6	3.3	3.4	2.9	2.5		2.5	2.0		1.7	
32.0	4.6	4.2	3.9	3.9	3.4	3.2	3.3	2.8	2.5		2.4	1.9		1.6	
34.0	4.5	4.1	3.8	3.8	3.3	3.1	3.2	2.7	2.4		2.3	1.9		1.6	
36.0	4.3	3.9	3.7	3.6	3.2	3.0	3.0	2.7	2.4		2.3	1.8		1.5	
38.0	4.1	3.8	3.6	3.5	3.1	2.9	2.9	2.6	2.3		2.2	1.8		1.5	
40.0	4.0	3.7	3.5	3.4	3.0	2.8	2.8	2.5	2.3		2.2	1.8		1.4	
44.0	3.7	3.5	3.4	3.2	2.8	2.7	2.6	2.3	2.2		2.1	1.7		1.4	
48.0	3.3	3.3	3.2	3.0	2.7	2.6	2.5	2.2	2.1		2.0	1.6		1.3	
52.0	2.5	2.8	2.9	2.7	2.6	2.4	2.3	2.1	2.0		1.9	1.5		1.2	
56.0	1.8	2.0	2.1	2.0	2.4	2.3	2.1	2.0	1.9		1.8	1.4		1.2	
60.0	1.3	1.4	1.4	1.4	1.7	1.9	1.6	1.9	1.8		1.6	1.4		1.1	
64.0					1.2	1.2	1.1	1.4	1.6		1.1	1.3		1.1	
68.0								1.0	1.0			1.1			

%	I			II			III			IV			V		
		100			100			100			100			100	

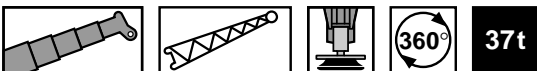

m	56.7 m + 13.2 m			56.7 m + 19.2 m			56.7 m + 25.2 m			56.7 m + 31.2 m			56.7 m + 37.2 m		
	0°	20°	40°	0°	20°	40°	0°	20°	40°	0°	20°	40°	0°	20°	
11.0	7.5														
12.0	7.5			5.6			4.2								
14.0	7.5			5.6			4.2				3.2				
16.0	7.1	5.6		5.6			4.2				3.1			2.2	
18.0	6.7	5.4		5.6			4.2				3.0			2.1	
20.0	6.4	5.2	4.4	5.4	4.6		4.2				2.9			2.0	
22.0	6.1	5.1	4.3	5.1	4.4		4.0				2.9			2.0	
24.0	5.8	4.9	4.2	4.9	4.2		3.9	3.2			2.8			1.9	
26.0	5.6	4.8	4.2	4.7	4.1	3.7	3.8	3.1			2.7			1.9	
28.0	5.3	4.7	4.1	4.5	3.9	3.6	3.7	3.0			2.6	2.1		1.8	
30.0	5.1	4.5	4.0	4.3	3.8	3.5	3.6	2.9	2.5		2.6	2.0		1.7	
32.0	4.9	4.4	4.0	4.1	3.6	3.4	3.5	2.9	2.5		2.5	2.0		1.7	1.3
34.0	4.7	4.3	3.9	4.0	3.5	3.2	3.3	2.8	2.4		2.4	1.9		1.6	1.3
36.0	4.6	4.1	3.8	3.8	3.4	3.2	3.2	2.7	2.4		2.3	1.9	1.7	1.6	1.2
38.0	4.4	4.0	3.8	3.7	3.3	3.1	3.1	2.7	2.3		2.3	1.8	1.6	1.5	1.2
40.0	4.2	3.9	3.7	3.6	3.2	3.0	3.0	2.6	2.3		2.2	1.8	1.6	1.5	1.1
44.0	4.0	3.7	3.6	3.3	3.0	2.8	2.8	2.4	2.2		2.1	1.7	1.5	1.4	1.1
48.0	3.3	3.5	3.4	3.2	2.8	2.7	2.6	2.3	2.1		2.0	1.6	1.5	1.3	1.0
52.0	2.6	2.8	2.9	2.8	2.7	2.6	2.4	2.2	2.1		1.9	1.6	1.4	1.2	1.0
56.0	1.9	2.1	2.1	2.1	2.4	2.5	2.2	2.1	2.0		1.8	1.5	1.4	1.1	
60.0	1.3	1.4	1.3	1.5	1.8	1.8	1.6	2.0	1.9		1.7	1.4	1.3	1.1	
64.0				1.0	1.2	1.1	1.1	1.5	1.6		1.2	1.4	1.3	1.0	
68.0												1.2	1.3		

%	I			II			III			IV			V		
		93			93			93			93			93	

Hubhöhen  
Lifting heights  
Hauteurs de levage  
Alturas de elevación

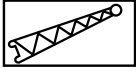
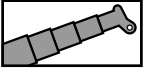

37t

DIN/ISO

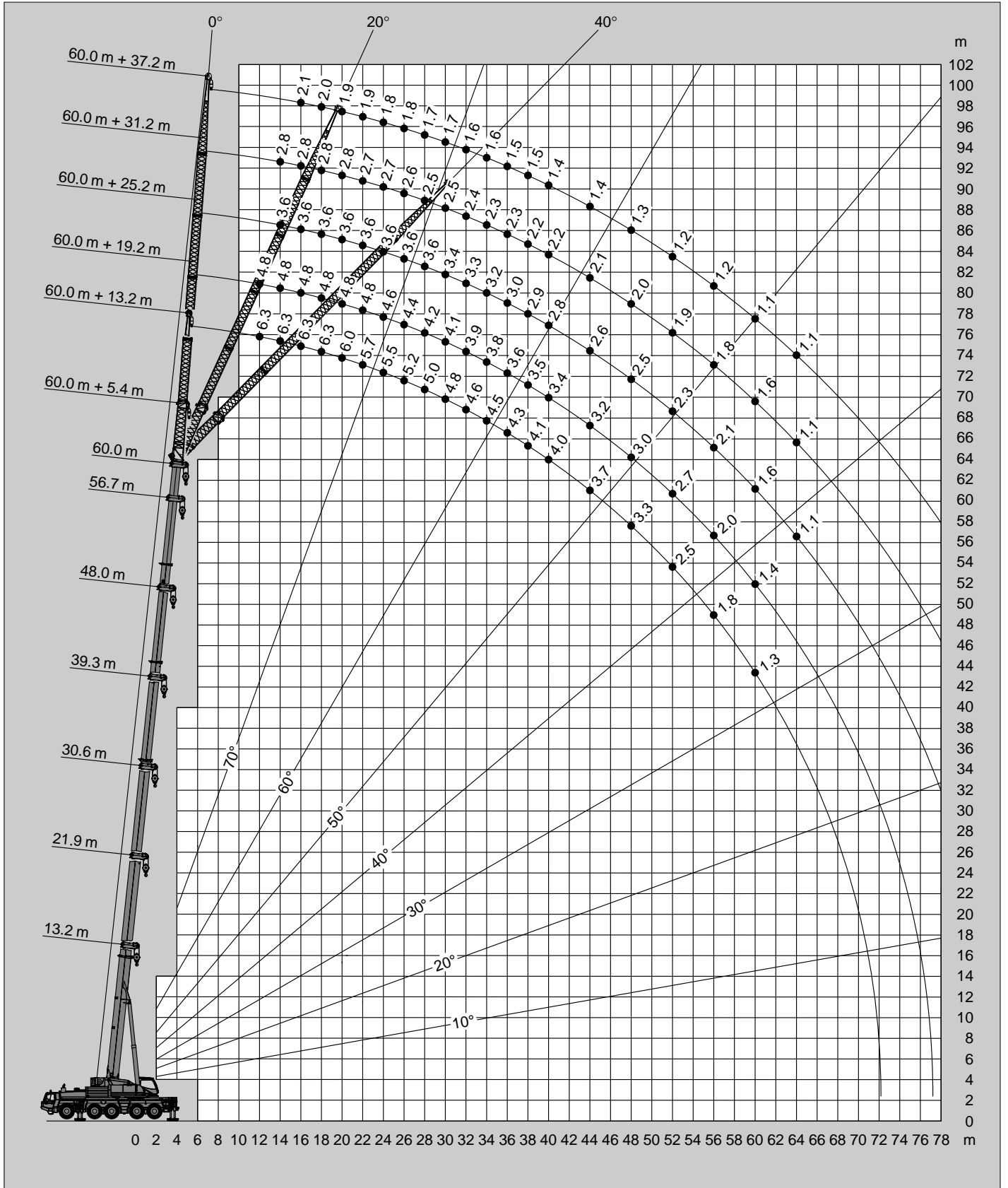

Tragfähigkeiten  
Lifting capacities  
Capacités de levage  
Capacidades de elevación

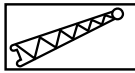
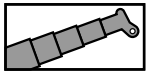

25t

DIN / ISO

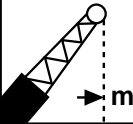
 m	13.2 m + 5.4 m			56.7 m + 5.4 m			60.0 m + 5.4 m		
	0°	20°	40°	0°	20°	40°	0°	20°	40°
3.0	33.2								
3.5	31.4	23.7							
4.0	30.6	22.5							
4.5	29.1	22.2	18.5						
5.0	28.4	21.6	18.2						
6.0	26.0	20.5	17.9						
7.0	24.5	19.8	17.5						
8.0	22.9	19.0	17.2						
9.0	21.6	18.5	16.9						
10.0	20.5	18.0	16.8	10.7					
11.0	19.6	17.5	16.8	10.3			9.6		
12.0	18.8	17.2	16.8	10.0	9.2		9.3	8.6	
14.0	17.5	16.8		9.4	8.7	8.2	8.7	8.1	7.7
16.0	16.8			8.8	8.2	7.8	8.2	7.7	7.3
18.0				8.4	7.8	7.5	7.8	7.3	7.0
20.0				7.9	7.5	7.2	7.4	7.0	6.7
22.0				7.5	7.2	6.9	7.0	6.7	6.4
24.0				7.2	6.9	6.6	6.7	6.4	6.2
26.0				6.8	6.6	6.4	6.4	6.1	6.0
28.0				6.5	6.3	6.2	6.1	5.9	5.8
30.0				6.3	6.0	5.9	5.8	5.6	5.5
32.0				5.6	5.8	5.7	5.6	5.4	5.3
34.0				4.8	5.1	5.2	4.8	5.1	5.1
36.0				4.1	4.3	4.5	4.1	4.3	4.5
38.0				3.5	3.7	3.8	3.5	3.7	3.8
40.0				2.9	3.1	3.2	2.9	3.1	3.2
44.0				2.0	2.1	2.2	2.0	2.1	2.2
48.0				1.2	1.3	1.3	1.2	1.3	1.4

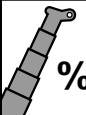
 %	I	II	III	IV	V	
		0			93	100
		0			93	100
		0			93	100
		0			93	100
		0			93	100

Hubhöhen  
Lifting heights  
Hauteurs de levage  
Alturas de elevación

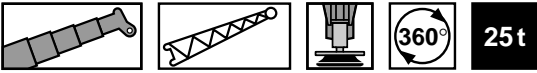

DIN/ISO

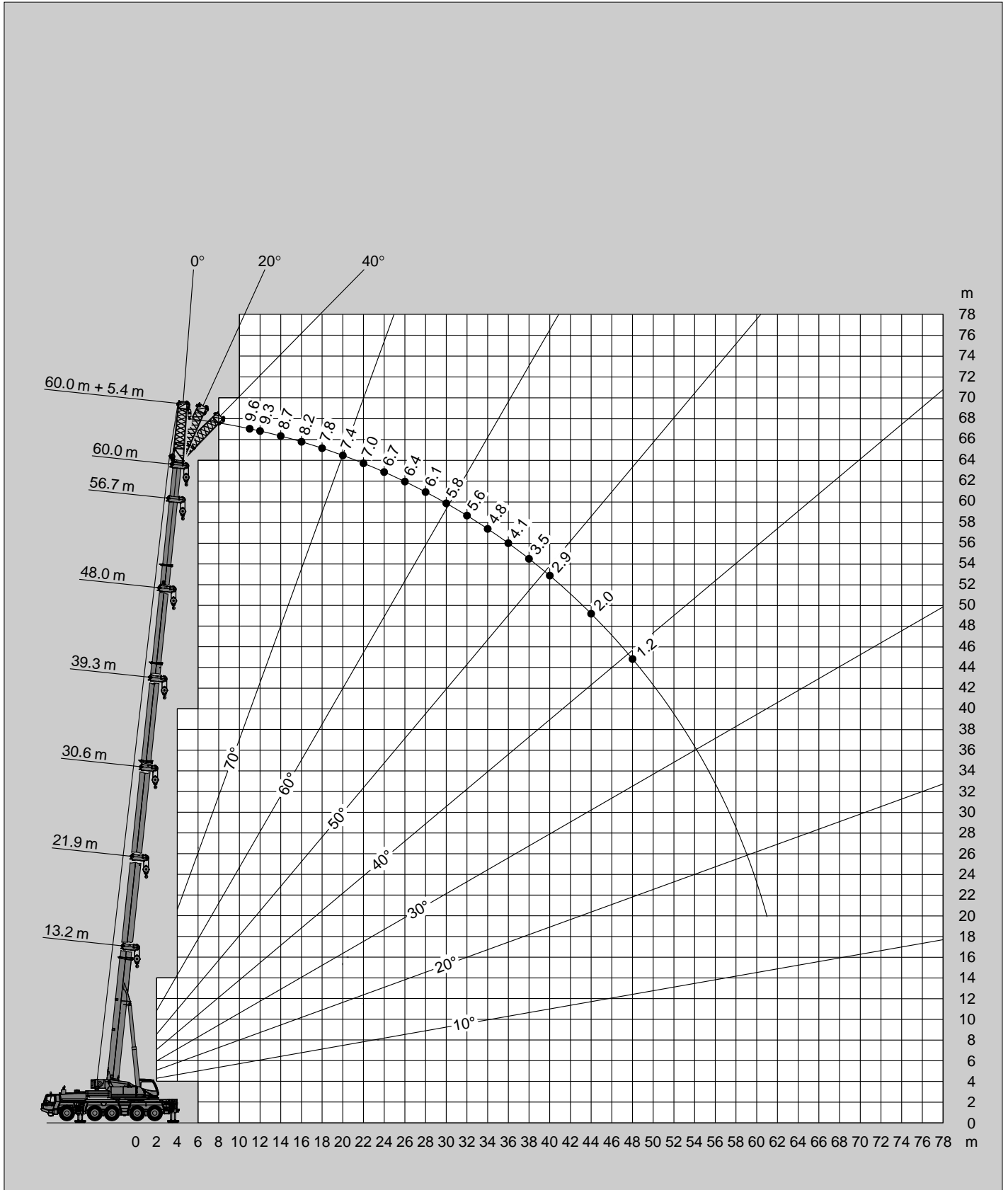

Tragfähigkeiten  
Lifting capacities  
Capacités de levage  
Capacidades de elevación

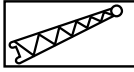
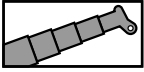

25t

DIN / ISO

m	60.0 m + 13.2 m			60.0 m + 19.2 m			60.0 m + 25.2 m			60.0 m + 31.2 m			60.0 m + 37.2 m		
	0°	20°	40°	0°	20°	40°	0°	20°	40°	0°	20°	40°	0°	20°	40°
12.0	6.3			4.8											
14.0	6.3			4.8			3.6			2.8					
16.0	6.3			4.8			3.6			2.8			2.1		
18.0	6.3	5.3		4.8			3.6			2.8			2.0		
20.0	6.0	5.2	4.4	4.8	4.4		3.6			2.8			1.9		
22.0	5.7	5.0	4.3	4.8	4.2		3.6			2.7			1.9		
24.0	5.5	4.9	4.2	4.6	4.0		3.6	3.1		2.7			1.8		
26.0	5.2	4.7	4.1	4.4	3.9	3.5	3.6	3.0		2.6			1.8		
28.0	5.0	4.5	4.1	4.2	3.7	3.4	3.6	2.9		2.5	2.0		1.7		
30.0	4.8	4.3	4.0	4.1	3.6	3.3	3.4	2.9	2.5	2.5	2.0		1.7		
32.0	4.6	4.2	3.9	3.9	3.4	3.2	3.3	2.8	2.5	2.4	1.9		1.6		
34.0	4.5	4.1	3.8	3.8	3.3	3.1	3.2	2.7	2.4	2.3	1.9		1.6		
36.0	4.3	3.9	3.7	3.6	3.2	3.0	3.0	2.7	2.4	2.3	1.8		1.5		
38.0	4.0	3.8	3.6	3.5	3.1	2.9	2.9	2.6	2.3	2.2	1.8		1.5		
40.0	3.4	3.7	3.5	3.4	3.0	2.8	2.8	2.5	2.3	2.2	1.8		1.4		
44.0	2.4	2.9	3.1	2.6	2.8	2.7	2.6	2.3	2.2	2.1	1.7		1.4		
48.0	1.7	2.0	2.2	1.8	2.4	2.6	2.0	2.2	2.1	2.0	1.6		1.3		
52.0	1.0	1.3	1.4	1.2	1.6	1.9	1.3	1.9	2.0	1.4	1.5		1.2		
56.0					1.0	1.2		1.3	1.6		1.4				
60.0								1.0			1.0				

%	I	II	III	IV	V
	100				
	100				
	100				
	100				
	100				
	100				

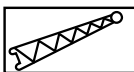
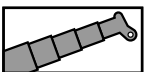

25t

DIN / ISO

m	56.7 m + 13.2 m			56.7 m + 19.2 m			56.7 m + 25.2 m			56.7 m + 31.2 m			56.7 m + 37.2 m		
	0°	20°	40°	0°	20°	40°	0°	20°	40°	0°	20°	40°	0°	20°	40°
11.0	7.5														
12.0	7.5			5.6			4.2								
14.0	7.5			5.6			4.2			3.2					
16.0	7.1	5.6		5.6			4.2			3.1			2.2		
18.0	6.7	5.4		5.6			4.2			3.0			2.1		
20.0	6.4	5.2	4.4	5.4	4.6		4.2			2.9			2.0		
22.0	6.1	5.1	4.3	5.1	4.4		4.0			2.9			2.0		
24.0	5.8	4.9	4.2	4.9	4.2		3.9	3.2		2.8			1.9		
26.0	5.6	4.8	4.2	4.7	4.1	3.7	3.8	3.1		2.7			1.9		
28.0	5.3	4.7	4.1	4.5	3.9	3.6	3.7	3.0		2.6	2.1		1.8		
30.0	5.1	4.5	4.0	4.3	3.8	3.5	3.6	2.9	2.5	2.6	2.0		1.7		
32.0	4.9	4.4	4.0	4.1	3.6	3.4	3.5	2.9	2.5	2.5	2.0		1.7	1.3	
34.0	4.7	4.3	3.9	4.0	3.5	3.2	3.3	2.8	2.4	2.4	1.9		1.6	1.3	
36.0	4.6	4.1	3.8	3.8	3.4	3.2	3.2	2.7	2.4	2.3	1.9	1.7	1.6	1.2	
38.0	4.0	4.0	3.8	3.7	3.3	3.1	3.1	2.7	2.3	2.3	1.8	1.6	1.5	1.2	
40.0	3.5	3.9	3.7	3.6	3.2	3.0	3.0	2.6	2.3	2.2	1.8	1.6	1.5	1.1	
44.0	2.5	2.9	3.1	2.7	3.0	2.8	2.8	2.4	2.2	2.1	1.7	1.5	1.4	1.1	
48.0	1.7	2.0	2.2	1.9	2.4	2.7	2.1	2.3	2.1	2.0	1.6	1.5	1.3	1.0	
52.0	1.0	1.3	1.4	1.2	1.7	1.9	1.4	2.0	2.1	1.5	1.6	1.4	1.2	1.0	
56.0					1.0	1.2		1.3	1.6		1.5	1.4	1.0		
60.0								1.0			1.0	1.3			

%	I	II	III	IV	V
	93				
	93				
	93				
	93				
	93				
	93				



Hubhöhen  
Lifting heights  
Hauteurs de levage  
Alturas de elevación

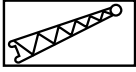
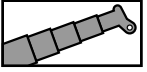

25t

DIN/ISO

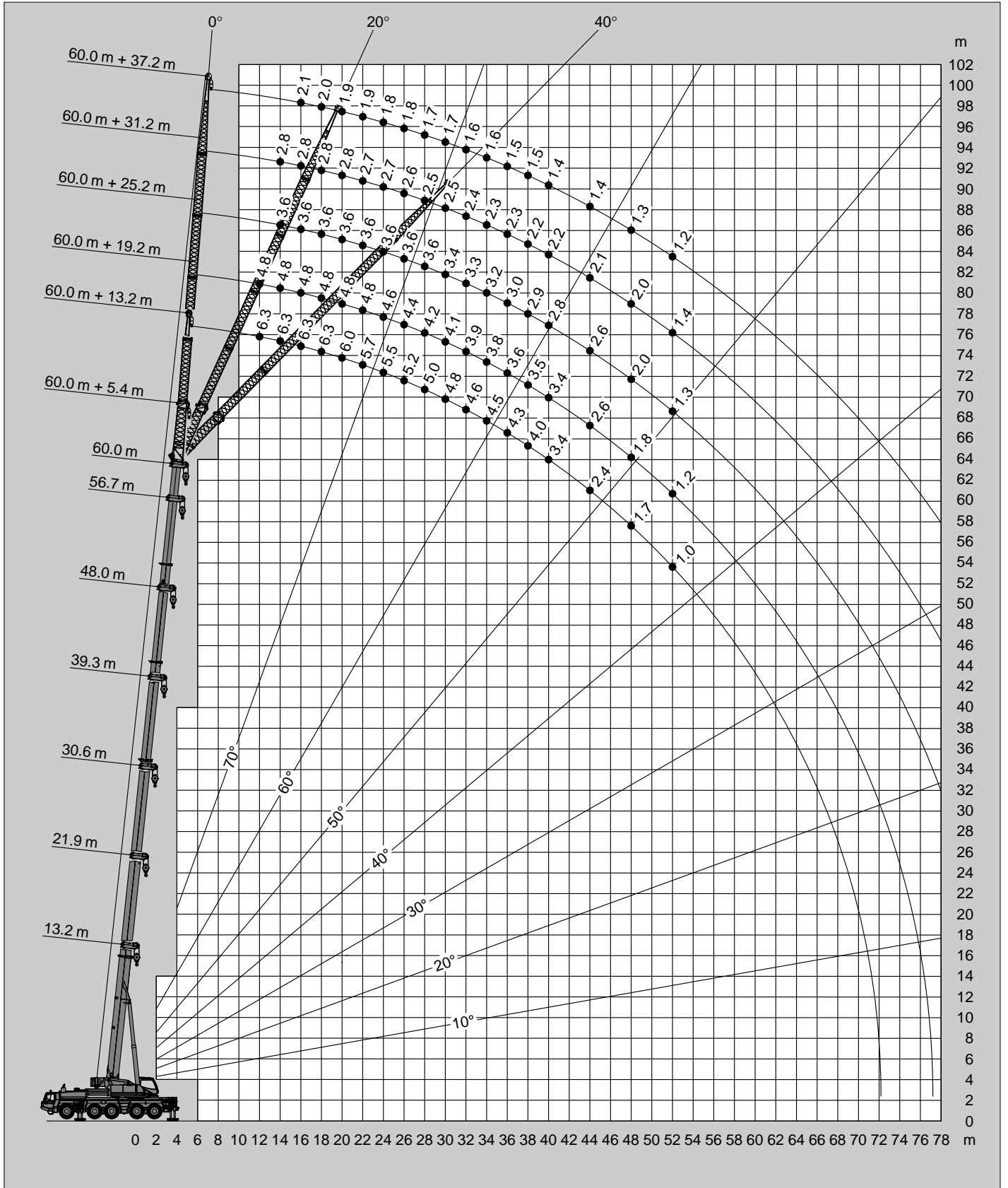

Tragfähigkeiten  
Lifting capacities  
Capacités de levage  
Capacidades de elevación

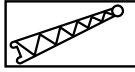
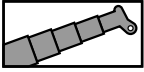

13t

DIN / ISO

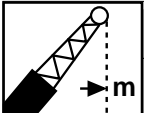
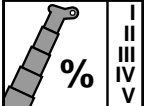
 m	13.2 m + 5.4 m			56.7 m + 5.4 m			60.0 m + 5.4 m			56.7 m + 13.2 m			60.0 m + 13.2 m		
	0°	20°	40°	0°	20°	40°	0°	20°	40°	0°	20°	40°	0°	20°	40°
3.0	33.2														
3.5	31.4	23.7													
4.0	30.6	22.5													
4.5	29.1	22.2	18.5												
5.0	28.4	21.6	18.2												
6.0	26.0	20.5	17.9												
7.0	24.5	19.8	17.5												
8.0	22.9	19.0	17.2												
9.0	21.6	18.5	16.9												
10.0	20.5	18.0	16.8	10.7											
11.0	19.6	17.5	16.8	10.3			9.6			7.5					
12.0	18.8	17.2	16.8	10.0	9.2		9.3	8.6		7.5			6.3		
14.0	17.5	16.8		9.4	8.7	8.2	8.7	8.1	7.7	7.5			6.3		
16.0	16.4			8.8	8.2	7.8	8.2	7.7	7.3	7.1	5.6		6.3		
18.0				8.4	7.8	7.5	7.8	7.3	7.0	6.7	5.4		6.3	5.3	
20.0				7.9	7.5	7.2	7.4	7.0	6.7	6.4	5.2	4.4	6.0	5.2	4.4
22.0				7.5	7.2	6.9	7.0	6.7	6.4	6.1	5.1	4.3	5.7	5.0	4.3
24.0				6.9	6.9	6.6	6.7	6.4	6.2	5.8	4.9	4.2	5.5	4.9	4.2
26.0				5.7	6.1	6.4	5.7	6.1	6.0	5.6	4.8	4.2	5.2	4.7	4.1
28.0				4.7	5.0	5.3	4.7	5.0	5.3	5.2	4.7	4.1	5.0	4.5	4.1
30.0				3.8	4.1	4.3	3.8	4.1	4.3	4.4	4.5	4.0	4.3	4.3	4.0
32.0				3.1	3.3	3.5	3.0	3.3	3.5	3.6	4.3	4.0	3.6	4.2	3.9
34.0				2.4	2.7	2.8	2.4	2.7	2.8	2.9	3.6	3.9	2.9	3.5	3.8
36.0				1.8	2.1	2.2	1.8	2.1	2.2	2.4	2.9	3.4	2.3	2.9	3.3
38.0				1.3	1.5	1.7	1.3	1.5	1.7	1.9	2.4	2.8	1.8	2.4	2.7
40.0					1.1	1.2		1.1	1.2	1.4	1.9	2.2	1.4	1.9	2.2
44.0											1.1	1.3			1.3
 %	I	0			93			100			93			100	
	II	0			93			100			93			100	
	III	0			93			100			93			100	
	IV	0			93			100			93			100	
	V	0			93			100			93			100	

Hubhöhen  
Lifting heights  
Hauteurs de levage  
Alturas de elevación

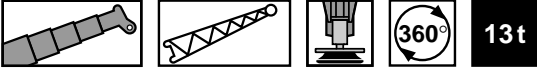

DIN/ISO

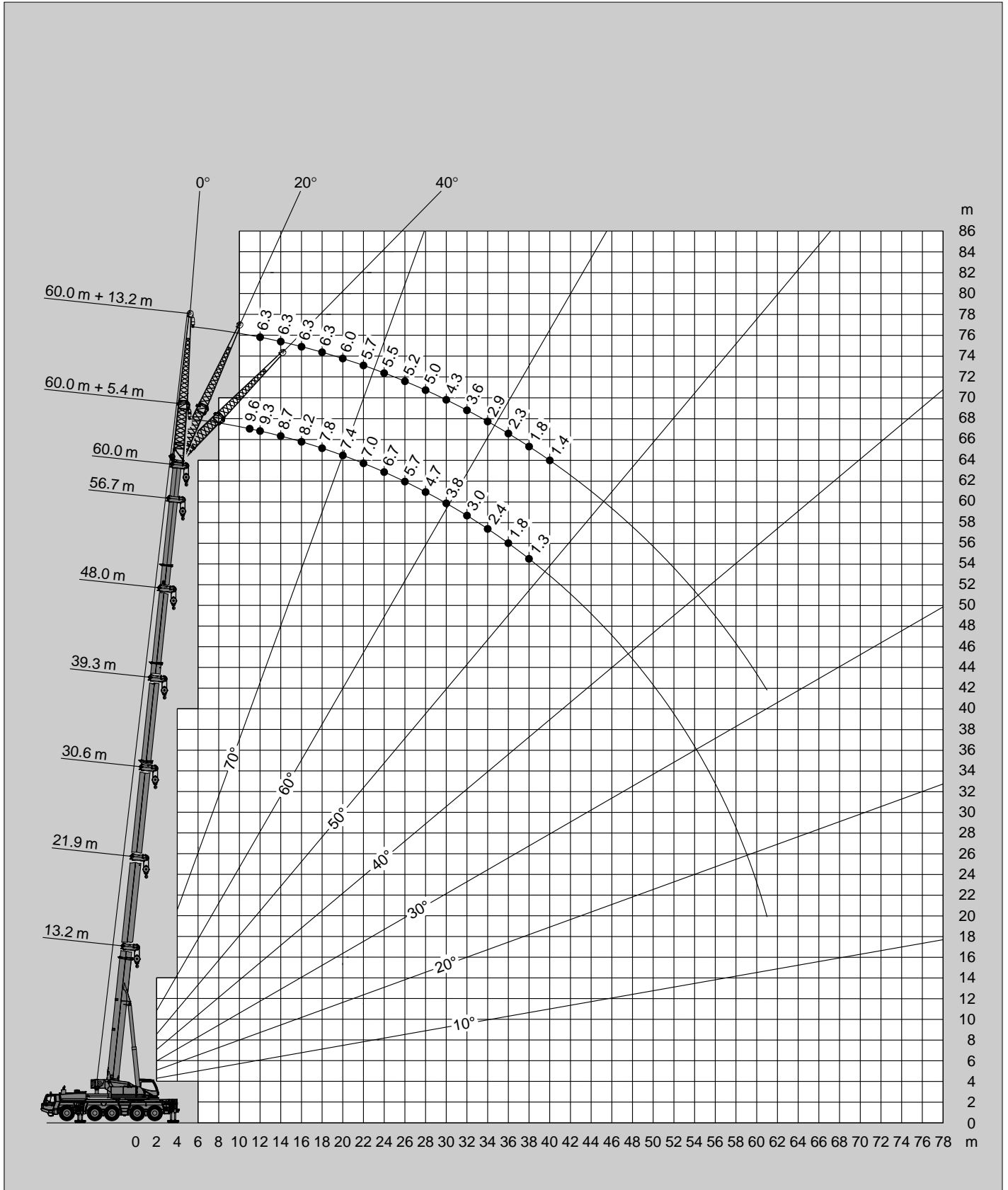

### Anmerkungen zu den Traglasttabellen

Die Tragfähigkeiten im Festigkeitsbereich basieren auf DIN 15018 Blatt 2 und Blatt 3 und F.E.M.

Die Tragfähigkeiten im Standsicherheitsbereich entsprechen DIN 15019 Teil 2 / ISO 4305.

Die zulässige Windgeschwindigkeit beträgt maximal 10 m/sec.

Die Tragfähigkeiten sind in metrischen Tonnen angegeben.

Das Gewicht des Lasthakens bzw. der Hakenflasche und weiterer Anschlagmittel ist von der Tragfähigkeit abzuziehen.

Die Tragfähigkeiten für den Teleskopausleger gelten nur bei demon- tierter Spitze.

Die Ausladung ist der horizontale Abstand von Mitte Drehkranz bis Mitte freihängender, nicht schwingender Last.

Tragfähigkeitsänderungen vorbehalten.

Obige Angaben dienen nur zur Information. Die Bedienungsanlei- tungen müssen zu Rate gezogen werden, bevor die Maschine in Betrieb genommen wird. Alle hier gemachten Angaben beziehen sich auf die Standard-Ausführung. Jegliche Ausrüstungsverände- rungen können die angegebenen Werte beeinflussen.

### Remarks relating to the rating charts

The lifting capacities in the structural area are based on DIN 15018 parts 2 and 3 and F.E.M.

The lifting capacities in the stability area are based on DIN 15019 part 2 / ISO 4305.

The maximum permissible wind speed for crane operation is 10 m/sec.

The lifting capacities shown are in metric tons.

The weight of load handling devices such as hook blocks, slings, etc., must be considered as part of the load and must be deducted from the lifting capacities.

The lifting capacities for the telescopic boom apply to a crane with no boom extensions being stowed or mounted on the crane.

The working radius is the horizontal distance from the centre of rotation to the centre of the freely suspended non-oscillating load.

The lifting capacities are subject to change without prior notice.

The above remarks are for basic information only and the operator's manual must be consulted before operating this crane. All data and performances refer to the standard crane. The addition of optional and other equipment may affect the performance of the crane.

### Remarques relatives aux tableaux des charges

Les forces de levage sont conformes aux normes DIN 15018, p. 2 et 3, et F.E.M.

Les forces de levage dans la partie de stabilité au renversement sont conformes aux normes DIN 15019, chap. 2 / ISO 4305.

La grue peut travailler aux vitesses de vent allant jusqu'à 10 m/s.

Les forces de levage sont données en tonnes métriques.

Le poids du crochet-moufle et de tous les accessoires d'élingage font partie de la charge et sont à déduire des charges indiquées.

Les forces de levage indiquées pour la flèche télescopique s'entendent fléchette déposée.

Comme portée, on entend la distance horizontale du centre de la couronne de rotation au centre de la charge librement suspendue et non oscillante.

Sauf modification de forces de levage.

Les données ci-dessus servent à titre d'information. Avant la mise en marche de la grue il est conseillé d'étudier les instructions de service. Toutes les données indiquées ci-dessus se réfèrent à la machine de base. Tout changement de l'équipement de la grue peut influencer ces valeurs.

### Notas relativas a los graficos de carga

En cuanto a los datos referentes a resistencia, las capacidades de carga están basados sobre las normas DIN 15018, pág. 2 y 3, y F.E.M.

En cuanto a los datos referentes a estabilidad anti-vuelco, las capacidades de carga están basados sobre las normas DIN 15019, Cap. 2 / ISO 4305.

La velocidad anemométrica max. admisible es de 10 m/seg.

Las capacidades de carga indicadas en las tablas corresponden a toneladas métricas.

Hay que deducir los pesos del gancho, eslingas y de otros dispositivos para fijación de cargas de los valores indicados en las tablas.

Las capacidades de carga referentes a la pluma telescópica valen solamente si el plumín está desmontada.

Como alcance se entiende la distancia horizontal desde el centro de la corona de giro hasta el centro de la carga suspendida libremente y no oscilante.

Salvo modificación de capacidades de carga, sin previo aviso.

Los datos arriba indicados sirven solamente para su información. Hay que leer las instrucciones para el uso antes de la puesta en servicio de la máquina. Todos los datos mencionados en las presentes tablas rigen para los modelos standard. Cualquier modificación del equipo montado puede dar lugar a modi-ficaciones de aquellos valores.

Gegengewichtvarianten  
 Counterweight versions  
 Variations des contrepoids  
 Variaciones de contrapeso

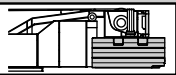
 Gegengewicht / Counterweight Contrepoids / Contrapeso	1 x	1 x	2 x	1 x	1 x	1 x
	①	②	③	④	⑤	⑥
(t)	1.0	12.0	7.0	12.0	10.2	1.8

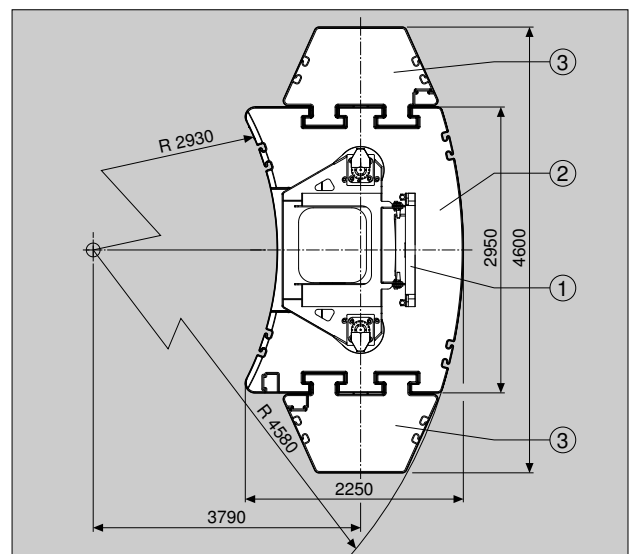
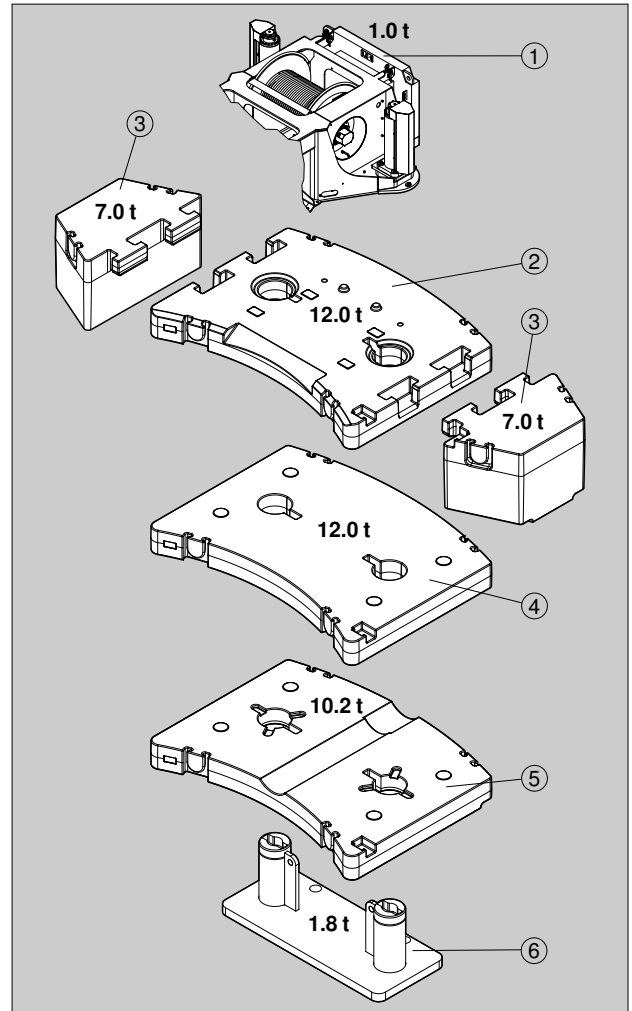
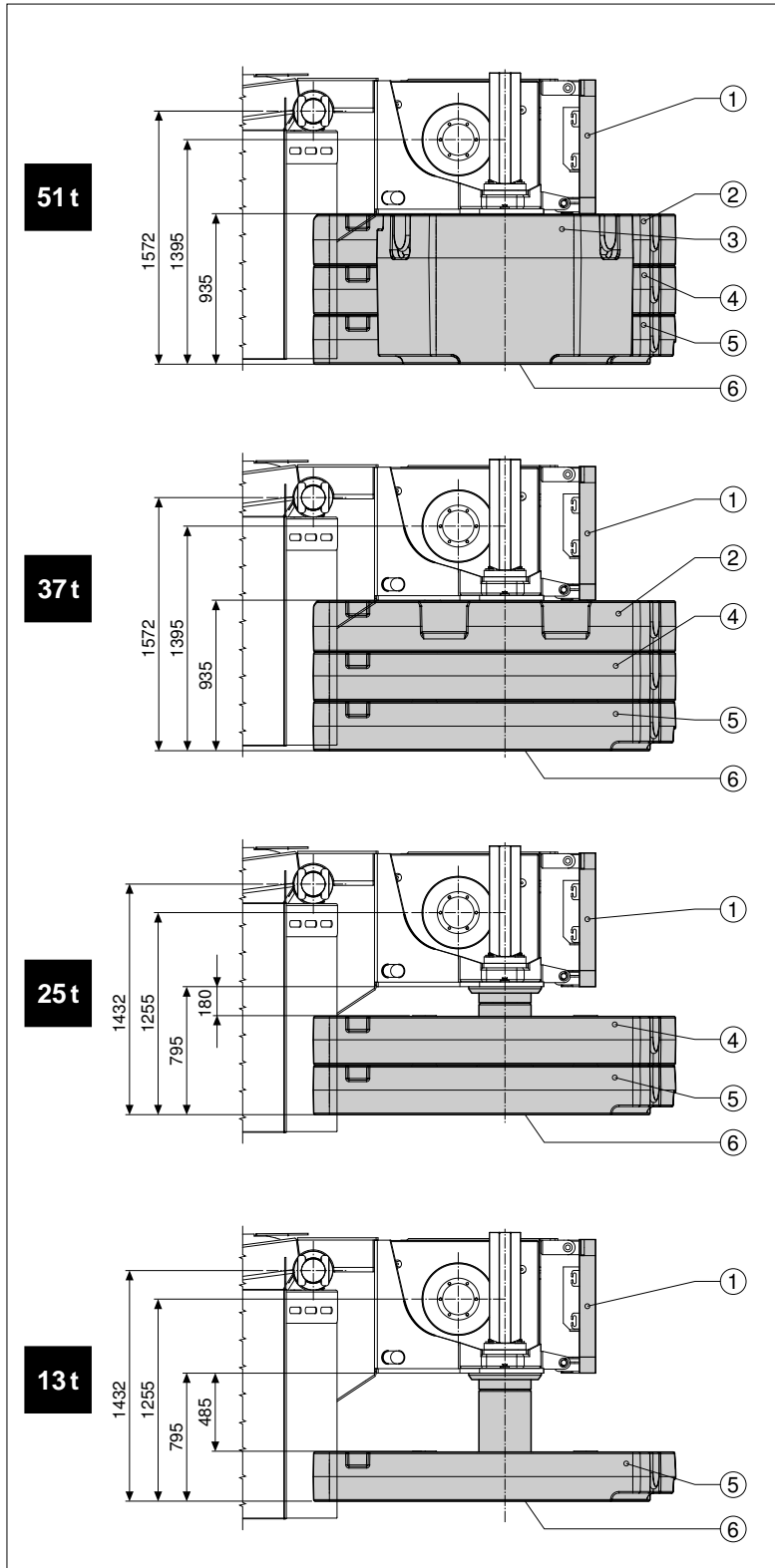

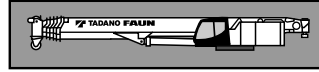
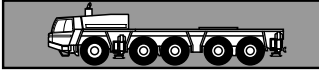

**Rahmen** Verwindungs- und biegesteife Schweißkonstruktion aus hochfestem Feinkornstahl. Zentralschmieranlage.

**Abstützung** 4-Punkt-Abstützung, hydraulisch, Bedienungsmöglichkeiten an beiden Seiten des Fahrgestelles und in der Oberwagenkabine.  
Abstützbasis 8,3 m (und 5,6 m) x 8,98 m.

**Motor** Mercedes-Benz 8-Zylinder-Dieselmotor OM 502 LA (Euromot III A / EPA III), wassergekühlt, Leistung 390 kW (530 PS) bei 1800 min<sup>-1</sup>. Drehmoment 2400 Nm (245 kpm) bei 1300 min<sup>-1</sup>. Motorleistung nach 80 / 1269 / EWG. Kraftstoffbehälter 530 l.

**Getriebe** ZF-AS-Tronic 16 AS 2602 mechanisches Schaltgetriebe mit elektronisch-pneumatisch betätigter Trockenkupplung und vollautomatischer Schaltung mit 16 Vorwärts- und 2 Rückwärtsgängen.

**Verteilergetriebe** 2-stufiges Verteilergetriebe.

**Antrieb** 10 x 8

#### Achsen

1. Achse: gelenkt, angetrieben, Differentialsperre quer.
2. Achse: gelenkt, angetrieben, zuschaltbar, Differentialsperre quer.
3. Achse: nicht gelenkt, nicht angetrieben, liftbar.
4. Achse: gelenkt, angetrieben, Differentialsperre längs und quer.
5. Achse: gelenkt, angetrieben, Differentialsperre quer.

**Achsaufhängung** Hydropneumatische Federung mit Niveauregulierung.

**Bremsen** Druckluft-Zweikreis-Bremsanlage. Feststellbremse als Federspeicherbremse an der 2., 4. und 5. Achse wirkend. Intarder und Konstantdrosselanlage mit Auspuffklappenbremse als Dauerbremse.

**Räder** 10-fach 16.00 R 25 (445/95 R 25).

**Lenkung** ZF-Servocom-Zweikreis-Hydraulenlenkung mit Notlenkpumpe. Mechanische Lenkung der 1. und 2. Achse und Mitlenken der 4. Achse bis zu einer Geschwindigkeit von 25 km/h und der 5. Achse bis zu einer Fahrgeschwindigkeit von 50 km/h.

**Unterwagenkabine** Zwei-Mann-Frontfahrerhaus in Stahl-Kunststoff-Verbund-Konstruktion, Sicherheitsverglasung, luftgefederte Sitze und motorabhängige Warmwasserheizung, Kontroll- und Bedienungselemente für den Fahrbetrieb, Tempomat-Funktion.

**Elektrische Anlage** 24 Volt-Gleichstrom, 2 Batterien, Verdrahtung mit CAN-Bus-Komponenten, integrierte Eigendiagnose Faun-CSS-System, Abstützbeleuchtung. Die elektrische Anlage entspricht der EG-Norm.

**Zusatzrüstung** (gegen Mehrpreis)  
Anhängerkupplung, Zusatzheizung, Motorvorwärmung, Klimaanlage, ABS, 20.5 R 25 (525/80 R 25) Bereifung, Reserverad, Sonderlackierung und Beschriftung, Stützkraftanzeige.

Weitere Zusatzrüstung auf Anfrage.

**Rahmen** Verwindungssteife Schweißkonstruktion mit einer außenverzahnten, einreihigen Kugeldrehverbindung, um 360° unbegrenzt drehbar. Zentralschmieranlage.

**Motor** Mercedes-Benz 6-Zylinder-Dieselmotor OM 906 LA (Euromot III A / EPA III), wassergekühlt. Drehzahl ist über Fußpedal stufenlos regelbar, Leistung 138 kW (188 PS) bei 1800 min<sup>-1</sup>. Drehmoment 750 Nm (76 kpm) bei 1200 - 1600 min<sup>-1</sup>. Motorleistung nach DIN 6270B / DIN 6271. Kraftstoffbehälter 250 l.

**Hydraulik System** Diesel-hydraulisch mit 3-Kreis-Hydraulik, 1 Axialkolbendoppelpumpe und 1 Axialkolbenpumpe.

**Steuerung** Zwei 4-fach Kreuzsteuerhebel mit elektrischer Vorsteuerung.

**Teleskopausleger** Sechsteiliger Teleskopausleger aus hochfestem Feinkornstahl, bestehend aus einem Grundausleger und 5 Teleskopteilen, 1 Teleskopzylinder, hydraulisch unter Teillast teleskopierbar. 13,2 m - 60,0 m lang.

**Wippwerk** Ein Differentialzylinder mit angebaute Senkbremssperrventil.

**Hubwerk** Axialkolben-Motor, Hubwerkstrommel mit eingebautem Planetengetriebe und federbelasteter Hydro-Lamellenbremse mit integriertem Freilauf beim Heben. Hubseil mit 'Super-Stop' Einrichtung.

**Drehwerk** Axialkolben-Motor, dreistufiges Planetengetriebe mit automatischer Feststellbremse, offener Kreis mit Drehwerk-Freischaltung. Drehgeschwindigkeit stufenlos von 0 - 1,8 min<sup>-1</sup>.

**Gegengewicht** Gesamtgewicht 51 t teilbar. Die Bedienung erfolgt aus der Oberwagenkabine.

**Oberwagenkabine** Großräumige Krankabine in Stahl-Kunststoffausführung mit Sicherheitsverglasung mit getönten Scheiben, kippbarem Arbeitsplatz mit verstellbarem, gefedertem, gedämpftem Fahrersitz, motorabhängige und motorunabhängige Warmwasserheizung (mit Motor-Vorwärmung), Kontroll- und Bedienungselemente sowie graphische LCD-Anzeige für Kranbetrieb.

**Elektrische Anlage** 24 Volt-Gleichstrom, 2 Batterien.

**Sicherheitseinrichtungen** 'Lift Adjuster', Lastmomentbegrenzung (LMB), Windmesser, Arbeitsbereichsbegrenzung, Hubendschalter, Windenendschalter, Seilwindendrehmelder, Sicherheitsventile gegen Rohr- und Schlauchbrüche. Sperrventile an Hydraulik-Zylindern.

**Zusatzrüstung** (gegen Mehrpreis)  
Auslegerverlängerungen von 13,2 m bis 37,2 m, Schwerlastspitze 5,4 m, Gegengewichtsvarianten 13 t / 25 t / 37 t, Unterflaschen von 10 t bis 160 t, Klimaanlage, 2. Hubwerk (wie Hauptwinde), Sonderlackierung und Beschriftung.

Weitere Zusatzrüstung auf Anfrage.

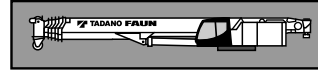

**Frame** Torsion resistant, welded construction made from high strength, fine-grained steel. Central lubricating system.

**Outriggers** 4 point, double telescopic hydraulic outriggers with controls on both sides of carrier and in superstructure cab. Outrigger base 8.3 m (5.6 m mid extension) x 8.98 m.

**Carrier engine** Mercedes-Benz 8 cylinder model OM 502 LA (Euromot III A/EPA III), water-cooled diesel engine. Rated at 390 kW (530 HP) at 1800 min<sup>-1</sup>. Torque 2400 Nm (245 kpm) at 1300 min<sup>-1</sup>. Engine rating according to 80/1269/EWG. Fuel tank 530 l.

**Transmission** ZF-AS-Tronic 16 AS 2602 mechanical transmission with electro-pneumatically operated dry-type clutch and automatic gear shifting with 16 forward gears and 2 reverse gears.

**Transfer Case** Two stage.

**Drive** 10 x 8

#### Axles

1<sup>st</sup> axle: steered, driven.  
 2<sup>nd</sup> axle: steered, driven.  
 3<sup>rd</sup> axle: not steered, not driven, lift axle.  
 4<sup>th</sup> axle: steered, driven, with longitudinal differential lock.  
 5<sup>th</sup> axle: steered, driven.  
 All driven axles with transverse differential locks.

**Suspension** Hydro-pneumatic with levelling adjustment.

**Brake system** Service brakes: dual circuit compressed air system. Parking brake: spring loaded type acting on 2<sup>nd</sup>, 4<sup>th</sup> and 5<sup>th</sup> axles. Auxiliary brakes: intarder, engine exhaust brake and constant throttle engine brake system.

**Tyres** (10) 16.00 R 25 (445/95 R 25).

**Steering system** ZF-Servocom, dual circuit hydraulic steering with emergency steering pump, mechanical hydraulically-assisted steering of front two axles and automatic steering of the 4<sup>th</sup> axle up to a travel speed of 25 km/h and of the 5<sup>th</sup> axle up to 50 km/h.

**Carrier cab** Two man full width cab of composite (steel sheet metal and fibre-glass) structure, with safety glass, air-cushioned adjustable seats, engine dependent hot-water heater. Complete controls and instrumentation for road travel. Speed control.

**Electrical system** 24 volt DC system, 2 batteries, CAN-Bus system with Faun CSS integrated self-diagnosis system, outrigger lighting. Electrical system conforms with EEC regulations.

**Optional Equipment** (at extra charge)  
 Towing attachment, additional heater, engine pre-heat, air conditioning, ABS, 20.5 R 25 (525/80 R 25) tyres, spare wheel and tyre, special painting and lettering, outrigger load display.

Further optional equipment available upon request.

**Frame** Torsion-resistant, all-welded structure of high strength steel. Connected to carrier by single-row ball-bearing slewing ring with external gearing for 360° continuous rotation. Central lubricating system.

**Superstructure engine** Mercedes-Benz 6 cylinder model OM 906 LA (Euromot III A/EPA III), water cooled, diesel engine. PRM infinitely variable via foot pedal, rating 138 kW (188 HP) at 1800 min<sup>-1</sup>. Torque 750 Nm (76 kpm) at 1200 - 1600 min<sup>-1</sup>. Engine rating according to DIN 6270B/DIN 6271. Fuel tank 250 l.

**Hydraulic system** Three circuit diesel hydraulic system with 1 double axial piston pump and 1 axial piston pump.

**Controls** Electrical, 2 joy-stick levers for simultaneous operation of crane motions.

**Telescopic boom** 6 sections, made of high tensile, fine-grained steel, consisting of 1 base section and 5 telescoping sections extended by means of a single telescopic cylinder. All telescope sections extendable under partial load. 13.2 m to 60.0 m long.

**Derricking system** 1 double acting hydraulic cylinder with integral brake and holding valve.

**Main winch** Axial piston motor, winch drum with integrated planetary reduction and with hydraulically controlled spring-loaded, multiple disc brake and with integrated free rotation (no sagging of load when hoisting). Hoist cable with 'Super-Stop' easy reeving system.

**Slewing system** Axial piston motor with three-stage planetary reduction with a foot actuated or automatic service and a parking brake, open circuit with free slewing function. Speed infinitely variable 0 - 1.8 min<sup>-1</sup>.

**Counterweight** Total 51 t divisible, assembled and disassembled by hydraulic cylinders controlled from superstructure cab.

**Superstructure cab** Spacious panoramic cab of composite structure with safety (tinted) glass windows, tiltable cockpit with hydraulically cushioned adjustable seat, one engine dependent hot water heater and one engine independent hot-water heater (with engine pre-heat). Complete controls and instrumentation plus LCD graphic display for crane operation.

**Electrical system** 24 volt DC system, 2 batteries.

**Safety devices** 'Lift Adjuster', load moment device (LMD), anemometer, working area limiter, hoist limit switch, lower limit switch and drum turn indicator, safety valves against pipe and hose rupture, holding valves on hydraulic cylinders.

**Optional Equipment** (at extra charge)  
 Boom extensions 13.2 m to 37.2 m, heavy duty jib 5.4 m, counterweight variations 13 t / 25 t / 37 t, selection of hook blocks 10 t - 160 t, air conditioning, auxiliary winch (same as main winch), special painting and lettering.

Further optional equipment available upon request.

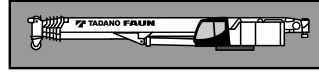

**Châssis** Construction mécano-soudée, en acier fin, résistante aux flexions et aux torsions. Système de graissage centralisé.

**Calage** Calage à 4 points, complètement hydraulique. Commande des stabilisateurs des deux côtés du châssis et de la cabine du grutier. Calage 8,3 m (aussi 5,6 m) x 8,98 m.

**Moteur** Mercedes Benz diesel 8 cylindres, modèle OM 502 LA (Euromot III A/EPA III), refroidi par eau, de 390 kW (530 CV) à 1800 min<sup>-1</sup>.  
Couple: 2400 Nm (245 kpm) à 1300 min<sup>-1</sup>.  
Puissance selon 80/1269/EWG.  
Dépôt de combustible 530 l.

**Boîte de vitesse** Boîte mécanique ZF-AS-Tronic, modèle 16 AS 2602 avec embrayage électro-pneumatique réglé à commande et boîte automatique, 16 vitesses AV et 2 vitesses AR.

**Boîte de transfert** Boîte de transfert.

**Entraînement** 10 x 8

#### Essieux

- 1<sup>er</sup> essieu: directeur, entraîné, blocage de différentiel transversal.
- 2<sup>ème</sup> essieu: directeur, entraîné, netraîné sur commande, blocage de différentiel transversal.
- 3<sup>ème</sup> essieu: non directeur, non entraîné, peut être levé.
- 4<sup>ème</sup> essieu: directeur, entraîné, blocage de différentiel longitudinal et transversal.
- 5<sup>ème</sup> essieu: directeur, entraîné, blocage de différentiel transversal.

**Suspension** Hydro-pneumatique, avec réglage de niveau.

**Freins** Système à air comprimé, à double circuit. Frein de stationnement: avec accumulateurs à ressort agissant sur le 2<sup>ème</sup>, 4<sup>ème</sup> et 5<sup>ème</sup> essieu. Frein continu: Intarder et frein sur échappement avec étrangleur.

**Pneus** 10 x 16.00 R 25 (445/95 R 25).

**Direction** Servocom à double circuit, marque ZF avec pompe de direction auxiliaire. Direction mécanique du 1<sup>er</sup> et 2<sup>ème</sup> essieu, à assistance hydraulique, avec pompe de direction auxiliaire direction du 4<sup>ème</sup> essieu jusqu'à une vitesse de 25 km/h et du 5<sup>ème</sup> essieu jusqu'à une vitesse de 50 km/h.

**Cabine** Cabine bi-place, construction en matière composite fibre de verre et acier. Vitrage en verre de sécurité, sièges à suspension pneumatique. Chauffage à eau chaude relié au moteur. Organes de contrôle et de commande pour la conduite. Régulateur de vitesse.

**Système électrique** 24 V courant continu, 2 batteries, connexion circuit électrique avec CAN-Bus. Équipement avec prise diagnostic et avec interprétation de code erreur de système FAUN CSS, illumination des calages. Conforme aux normes CE.

**Équipement supplémentaire** (avec supplément de prix) Attache-remorque, chauffage auxiliaire, préchauffage du moteur, climatisation, ABS, pneus 20.5 R 25 (525/80 R 25), roue de secours, peinture spéciale et inscription. Indicateur de pression sur les calages.

Autres équipements supplémentaires sur demande.

**Plate forme** Construction mécano-soudée résistante à la torsion. Couronne d'orientation à billes à une rangée, à denture extérieure, permettant une rotation illimitée sur 360°. Système de graissage centralisé.

**Moteur** Mercedes Benz diesel 6 cylindres, modèle OM 906 LA (Euromot III A/EPA III), refroidi par eau. Réglage du nombre de tours par pédale, de 138 kW (188 CV) à 1800 min<sup>-1</sup>. Couple: 750 Nm (76 kpm) à 1200 - 1600 min<sup>-1</sup>. Puissance selon DIN 6270B/DIN 6271. Dépôt de combustible 250 l.

**Système hydraulique** Diesel-hydraulique à 3 circuits, 1 double pompe à pistons axiaux et 1 pompe à pistons axiaux.

**Commande** 2 manipulateurs à commande en croix (4 sens), assistés électriquement.

**Flèche télescopique** 1 flèche de base et 5 éléments télescopiques en acier fin, 1 vérin télescopique, hydrauliquement télescopable avec charge partielle. Longueur de 13,2 m à 60,0 m.

**Mécanisme de relevage** 1 vérin différentiel muni de clapet de freinage de descente.

**Mécanisme de levage** Moteur hydraulique, tambour de levage avec boîte planétaire incorporée, frein d'arrêt à disques multiples à ressort, libéré lors du levage. Câble de levage avec dispositif 'Super-Stop'.

**Orientation** Moteur hydraulique avec entraînement planétaire à 3 gammes avec frein de stationnement automatique. Vitesse de rotation 0 à 1,8 min<sup>-1</sup> en continu.

**Contrepoids** Poids total 51 t divisible, commandé depuis la cabine du grutier.

**Cabine du grutier** Cabine de grue spacieuse, construction en matière combinée acier/synthétique, avec vitrage de sécurité en verre teinté, siège réglable et amorti hydrauliquement, inclinable avec instruments de commande, chauffage à eau chaude dépendant et indépendant du moteur (avec préchauffage du moteur), éléments de commande et de contrôle avec affichage digital pour travaux.

**Système électrique** 24 V courant continu, 2 batteries.

**Dispositifs de sécurité** 'Lift Adjuster', limiteur de charge (CEC), anémomètre, limitation de zone de travail, interrupteur de fin de course de levage et de treuil, indicateur du nombre de tours, soupapes de sécurité contre ruptures des conduites et flexibles, clapets sur verins hydraulique.

**Équipement supplémentaire** (avec supplément de prix) Fléchette de 13,2 m à 37,2 m, fléchette pour levage lourde 5,4 m, combinaison différentes de contrepoids 13 t/25 t/37 t, moufles de 10 t à 160 t, climatisation, 2<sup>ème</sup> treuil de levage (identique au treuil principale), peinture spéciale et inscription.

Autres équipements supplémentaires sur demande.



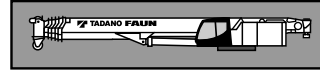

**Chasis portante** Construcción de acero de alta resistencia soldado, resistente a la torsión y a la flexión. Sistema de engrase central.

**Estabilizadores** Estabilizadores hidráulicos de 4 puntos. Posibilidad de manejo desde ambos lados del chasis portante y desde la cabina de la grúa. Extensión de los estabilizadores: 8,3 m (y 5,6 m) x 8,98 m.

**Motor** Mercedes Benz modelo OM 502 LA (Euromot III A / EPA III), 8 cilindros, diesel, refrigerado por agua. Nominal 390 kW (530 HP) a 1800 min<sup>-1</sup>. Par 2400 Nm (245 kpm) a 1300 min<sup>-1</sup>. Potencia del motor según 80/1269/EWG. Réservoir à carburant 530 l.

**Transmisión** Transmisión mecánica tipo ZF-AS Tronic modelo 16 AS 2602 con accionamiento electro - neumáticamente embrague en seco y cambio automático 16 marchas delanteras y 2 marchas traseras.

**Transmisión** Caja de distribución de dos escalones.

**Traacción** 10 x 8

#### Ejes

- 1º eje: de dirección, accionado, con bloqueo diferencial transversal.
- 2º eje: de dirección, accionado, conectar según necesidad, con bloqueo diferencial transversal.
- 3º eje: no accionado, no direccionable, elevable.
- 4º eje: de dirección, accionado, con bloqueo diferencial longitudinal y transversal.
- 5º eje: de dirección, accionado, con bloqueo diferencial transversal.

**Suspensión** Suspensión hidroneumática con regulación de nivel.

**Sistema de frenos** Accionamiento neumático de doble circuito. Freno de estacionamiento del tipo muelles cargados, liberados por aire, sobre los ejes 2º, 4º y 5º. Intarder y freno continuo: Sistema estrangulador y sobre el escape del motor diesel.

**Neumáticos** 10 x 16.00 R 25 (445/95 R 25).

**Dirección** Hidráulica ZF Servocom de doble circuito con bomba auxiliar de dirección. Dirección mecánica del 1º y 2º eje y direccionable del 4º eje hasta una velocidad de 25 km/h y del 5º eje hasta una velocidad de conducción de 50 km/h.

**Cabina** Cabina para dos personas, en construcción de acero y fibra de vidrio. Cristales de seguridad, asiento con suspensión neumática, calefacción por agua caliente del motor. Elementos de control e instrumentos para circulación por carretera. Regulador de velocidad.

**Sistema eléctrico** Sistema de 24 V c.c. con 2 baterías, conexiones eléctricas integradas en el sistema CAN-Bus, sistema integrado de diagnóstico Faun-CSS. Faros en gatos. El sistema eléctrico cumple la normativa CEE.

**Equipo adicional** (con suplemento de precio) Embrague de remolque, calefacción adicional, precalefacción del motor, climatización, ABS, neumáticos 20.5 R 25 (525/80 R 25), rueda de repuesto, pintura especial e rotulación. Control carga (gatos de apoyo).

Otros equipamientos sobre pedido.

**Superestructura** Construida en aceros soldados, resistente a la torsión. Corona de giro con rodamiento de una fila de bolas con dientes externos para giro continuo a 360°. Sistema de engrase central.

**Motor** Mercedes Benz modelo OM 906 LA (Euromot III A / EPA III), 6 cilindros, diesel, refrigerado por agua. Las revoluciones aumentan de forma gradual accionado el acelerador. Nominal 138 kW (188 HP) a 1800 min<sup>-1</sup>. Par 750 Nm (76 kpm) a 1200 - 1600 min<sup>-1</sup>. Potencia del motor según DIN 6270B / DIN 6271. Réservoir à carburant 250 l.

**Sistema hidráulico** Sistema hidráulico de 3 circuitos, 1 bomba doble de pistones axiales y una bomba de pistones axiales.

**Mandos** 2 palancas de control de tipo joy-stick para movimientos simultáneos de la grúa (4 direcciones), asistidos eléctricamente.

**Pluma telescópica** 6 secciones, un tramo base y 5 telescópicos de acero de alta resistencia soldado, 1 cilindro hidráulico, los tramos se pueden telescopar hidráulicamente bajo carga. Longitud de 13,2 m a 60,0 m.

**Elevación de pluma** Mediante un cilindro hidráulico de doble efecto con válvula de retención integrada.

**Cabrestante principal** Motor hidráulico de pistones axiales y caudal fijo. Tambor del cabrestante con reducción planetaria y frenos de disco múltiples accionado, con sistema libre de elevación. Cable de elevación con sistema de enhebrado fácil y 'Super-Stop'.

**Sistema de giro** Motor hidráulico de pistones axiales con reducción planetaria de tres etapas. Con freno de giro automático. Circuito abierto con mecanismo de giro libre con posibilidad de desconexión. Velocidad de giro gradual de 0 a 1,8 min<sup>-1</sup>.

**Contrapeso** Peso total 51 t divisible, accionado desde la cabina de la grúa.

**Cabina de la grúa** Cabina espaciosa y confortable, en construcción de acero y fibra de vidrio, con cristales coloreados de seguridad. Asiento del operador regulable amortiguado hidráulicamente, inclinable junto con los instrumentos y mandos, calefacción por agua caliente dependiente e independiente del motor (con precalefacción del motor). Controles, instrumentos y mandos de conducción como display digital LCD para la operación de la grúa.









**Sistema eléctrico** Sistema de 24 V c.c. con 2 baterías.



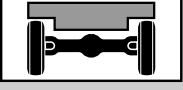

**Medidas de seguridad** 'Lift Adjuster', limitación del momento de carga (LMC), anemómetro, limitación del área de trabajo, interruptor de final de elevación, interruptor de 3 últimas vueltas en cabrestante, indicador de bajada o subida del cable del cabrestante, válvulas de seguridad para rotura de tubos y latiguillos. Válvulas de retención en los cilindros hidráulicos.

**Equipo adicional** (con suplemento de precio) Plumín de 13,2 m a 37,2 m, plumín de carga pesada 5,4 m, variantes de contrapeso 13 t/25 t/37 t, climatización, gancho de 10 a 160 t. 2º cabrestante (similar a cabrestante principal), pintura especial e rotulación.

Otros equipamientos sobre pedido.

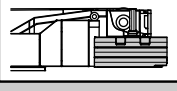
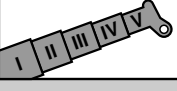
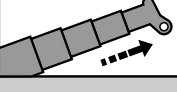
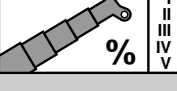
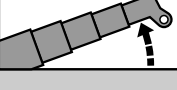
## Symbolerklärung Symbols Glossaire des symboles Glosario de simbolos

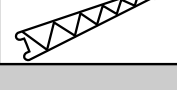
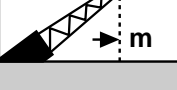
<b>DIN / ISO</b>	Siehe Seite 28 As on Page 28 Voyez la page 28 Véase la pagina 28
	Abstützung Outriggers Calage Estabilizadores
	Getriebe / Gang Transmission / Gear Boîte de vitesse / Rapport Transmisión / Marchas
	Achslast Axle load Charge à l'essieu Carga por eje
 <b>16.00</b> (445/95)	Räder / Größe Tyres / Size Pneus / Largeur Neumáticos / Tamaño de ruedas
	Gelände Off road Tout-terrain Todo terreno
	Straße On road En route En carretera
<b>V+</b>	Geschwindigkeiten Speeds Vitesses Velocidades
	Steigfähigkeit Gradeability Abtitude en pente Superacion de pendientes
	Drehwerk Slewing system Orientation Sistema de giro
<b>51t</b>	Gegengewicht Counterweight Contrepoids Contrapeso

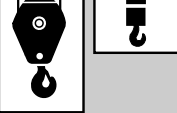
	Gegengewichtvarianten Counterweight versions Variations des contrepoids Variaciones de contrapeso
	Teleskopausleger Telescopic boom Flèche télescopique Pluma telescópica
	Teleskopieren Boom telescoping Télescopage de flèche Telescopaje de pluma
	Teleskopieren in % Boom telescoping in % Télescopage de flèche en % Telescopaje de pluma en %
	Wippwerk Derricking system Mécanisme de relevage Elevación de pluma
	Ausladung Radius Portée Radio
	Auslegerverlängerung Boom extension Fléchette Plumín
	Ausladung Radius Portée Radio
	Hubwerk Main winch Mécanisme de levage Cabrestante principal
	2. Hubwerk Auxiliary winch 2 <sup>ème</sup> treuil de levage 2 <sup>º</sup> cabrestante
	Unterflasche / Hakengeschirr Hook block / Swivel hook Moufle / Elingues Gancho / Gancho de bola