

### GENERAL DATA

<b>CRANE CAPACITY</b>	70t at 3.0m
<b>BOOM</b>	4-section, 11.4 m – 34.0 m
<b>DIMENSION</b>	
Overall Length	14.94 m
Overall Width (tracks extended)	5.72 m
Overall Width (tracks retracted)	3.81 m
Overall Width (tracks removed)	3.0 m
Overall Height	3.22 m
<b>MASS</b>	
Gross Vehicle Mass (Standard Equipment Package)	61,542 kg
<b>PERFORMANCE</b>	
Travel Speed	1.0 km/h – 2.8 km/h
Gradability	68%

### CRANE SPECIFICATION

#### MODEL

GTC-700EX

#### CAPACITY

70t at 3.0m

#### BOOM

4-section full power synchronized telescoping boom. Synchronized telescoping system consists of two double acting hydraulic cylinders with load holding valves and extension and retraction cables.

- Retracted Length: 11.4 m
- Extended Length: 34.0 m
- Extension Time: 102 s
- Elevating Angles: -1° to 78°
- Elevating Time: 64 s
- Boom Head: Seven, 483 mm diameter cast nylon sheaves on heavy-duty roller bearings

#### AUXILIARY BOOM HEAD

Quick reeve, single 483 mm diameter high-strength, cast nylon sheave mounted on a heavy-duty roller bearing.

#### HOOK BLOCKS

- Hook Block: 70t hook block - Five 483 mm diameter sheaves mounted on heavy duty roller bearings with swivel hook and safety latch.
- Headache Ball: 11t ball includes a swivel hook with a safety latch.

#### WINCHES

Planetary geared two-speed winch includes a bent axis hydraulic motor, multi-disc internal brake, counterbalance valve, grooved drum and cable follower. Drum rotation indicator is included (complete winch performance specs on Page 3)

- Main Winch
  - Rope Diameter and Length: 19mm x 213m
  - Single line pull: 78.2 kN (first layer)
  - Single line speed: 68.6 m/min (at the 4th layer)
- Auxiliary Winch
  - Rope Diameter and Length: 19mm x 107m
  - Single line pull: 78.2 kN (first layer)
  - Single line speed: 68.6 m/min (at the 4th layer)

#### TRAVEL

Each side frame contains a pilot controlled, two-speed track drive with hydraulic axial piston motor and parking brake.

Travel system provides skid steering and counter rotation.

- Low travel speed: 1.0 km/h
- High travel speed : 2.8 km/h
- Gradeability (unladen): 68%

#### COUNTERWEIGHT

Total 15,875 kg rear counterweight  
(Two pieces - 7,938 kg each)

#### SWING

Gear motor driving a planetary gear reducer with a shaft mounted pinion, external gear shear ball slew bearing bolted to the superstructure and the carbody allows the superstructure to rotate 360°

- Dual mode swing, free/lock selectable.
- Swing Speed: 0 - 2.2 rpm
- Swing Parking Brake: Spring applied failsafe brake with hydraulic release that is controlled from the operators cab
- Swing Service Brake: Hydraulically applied, controlled through foot actuated pedal
- House Lock System: 2-position, manually pinned

#### LOAD MOMENT INDICATOR

TADANO AML-C Rated Capacity Limiter and Anti-Two Block system

- Control function shutdown. Audible and visual warnings
- LCD screen provides a continuous display of working boom length, boom angle, working load radius, tip height, parts-of-line (operator set), machine track configuration (operator set), relative load moment, maximum permissible load and actual load.
- Anti-two block weight allows quick reeving of hook blocks.
- Optional 3-color light bar for external indication of load state.

#### FRAME

The frame is an all-steel, welded structure, precision machined to accept attachment of the boom and swing components.

**OPERATORS CAB**

Fully-enclosed, air conditioned all-steel modular cab with lockable swinging door, acoustical lining, anti-slip floor and tinted safety glass.

- Cab tilts 20°.
- Rear view cameras are appropriately located as are three remote control work lights.
- Vent window in the rear of the cab.
- Grab bars and steps are located for easy access to the cab.
- Defroster, heater, circulating fan
- 2-speed windshield wiper, top glass wiper
- Six-way adjustable fabric seat with headrest, seat belt
- Dome light
- Dry-chemical fire extinguisher
- Four-way electronic armrest mounted joysticks control swing, boom extend, main winch, auxiliary winch and boom hoist. Electronic foot pedals control the travel and swing service brake functions.
- Selectable control modes for: Fine Control, Auger, and hand control of travel functions.
- Seat and armrest termination switches immediately disable all hydraulic functions as the operator rises from the seat or lifts the left hand armrest.

Dash instrumentation: tachometer, voltmeter, oil pressure gauge, temperature gauge, hour meter and fuel gauge. Indicators are provided for crane level, load moment, drum rotation, air filter restriction, hydraulic oil temperature and filter restriction, engine oil pressure and temperature.

**ENGINE**

- Make/ Model: Cummins QSB 6.7
- Type: 6 Cylinder, Water cooled, 4 Cycle
- Aspiration: Turbocharged and Aftercooled
- Max. Output: 194 kW (260 hp) @ 2200 RPM
- Max Torque: 987 Nm (728 Lb-ft) @ 1500 RPM
- Piston Disp: 6.7 liter
- Bore x Stroke: 107mm x 124mm
- Emission Cert: U.S. EPA Tier 3, Euromot Stage IIIA
- Alternator: 130 amp

**ELECTRICAL SYSTEM**

12 VDC

**FUEL SYSTEM**

- Capacity: 416 liter
- Filtration: Inline fuel/water separator and engine mounted fuel filter

**HYDRAULIC SYSTEM**

- Hydraulic Pumps: Two high pressure, variable axial piston pumps with load sense and power limiting control for crane functions. One variable axial piston pump for cooling loop.
- Directional Valves: Multiple pressure and flow compensated valves with integrated relief valves
- Pump output: 583 liter/min @ 2100 RPM engine speed. 330 bar maximum pressure
- Reservoir 1,136 liter capacity, spin-on filler/breather, sight gauge, cleanout, and sump drain.
- Filtration: 5 micron, full flow tank mounted return filters with electrical clogging indicator. 5 micron pilot oil in-line pressure filter with electrical clogging indicator.
- Diagnostic ports provided for system, load sense, and pilot pressure

**SIDE FRAMES**

Two welded steel side frames are paired with a track group. The side frames extend and retract hydraulically and are controlled from the cab.

- Track Rollers: Two top and twelve bottom sealed rollers on each track frame Idler: Oil filled, self lubricating with spring type tensioner
- Track Shoes: 900mm, 3-bar semi grouser

**OPTIONAL EQUIPMENT**

- Boom Extension: Lattice type, swing away
  - Length: 9,1m
  - Head: Two, 483 mm diameter cast nylon sheaves on heavy-duty roller bearings
  - Max. Lifting Height: 43,3m
- Boom Jib: Lattice type, swing away, stores along boom extension
  - Length: 6,1m      - Offset Angles: 15° & 30°
  - Max. Lifting Height: 49,4m
- Three Section Boom: Hydraulically proportional full power boom:
  - Retracted Length: 7,9m
  - Extended Length: 16,4
  - Maximum Tip Height: 17,3m
- 45t hook block - Three 457 mm steel sheaves, swivel hook & safety latch
- Carbody Jack System: Hydraulic cylinder jack system and pendant control to facilitate quick removal of track frames for 3 m shipping width.
- Track Shoes: 760 mm 3-bar semi grouser
- Auger Ready Package: Includes hoses, fasteners and stowage bracket assembly mounted to the base section of the boom with a flow capability of 130 liter/min
- Complete Auger Package: Adds a two speed auger motor/gear box and one 1,52m kelly bar to the Auger Ready Package.
- Tool Circuit: Provides 23 liter/min and 45 liter/min at 176 bar through a 15,24m twin hose reel with quick disconnect fittings to operate open center tools.
- Free Fall Hoists: All winches are available in controlled free fall configurations.
- Cold Weather Packages: Cold weather options are available for operation to -40°C (Consult factory for application support)
- Clip on flat track shoes

## MAIN WINCH

Planetary geared two-speed winch includes a bent axis, variable displacement hydraulic motor and a multi-disc internal brake.  
Wire Rope: 175 m, 19 mm - 6 x 37 EIPS, IWRC, RRL. Line pulls are not based on wire rope strength. Drum rotation indicator is standard. indicator is standard.

Rope Layer	Maximum Line Pull	Full Load Line Speed	Layer	Total
1	78,2 kN	52 m/min	29 m	29 m
2	70,5 kN	57 m/min	31 m	60 m
3	64,2 kN	63 m/min	35 m	95 m
4	58,9 kN	69 m/min	38 m	133 m
5	54,5 kN	74 m/min	42 m	175 m

## AUXILIARY WINCH

Planetary geared two-speed winch includes a bent axis, variable displacement hydraulic motor and a multi-disc internal brake.  
Wire Rope: 107 m 19 mm 6 x 37 EIPS, IWRC, RRL. Line pulls are not based on wire rope strength. Drum rotation indicator is standard.

Rope Layer	Maximum Line Pull	Full Load Line Speed	Layer	Total
1	78,2 kN	52 m/min	29 m	29 m
2	70,5 kN	57 m/min	31 m	60 m
3	64,2 kN	63 m/min	35 m	95 m
4	58,9 kN	69 m/min	38 m	133 m
5	54,5 kN	74 m/min	42 m	175 m

## MACHINE WEIGHTS

STANDARD CRANE WITH 4 SECTION 34 m BOOM, 2 PIECE COUNTERWEIGHT & 900 mm TRACK SHOES	60,016 kg
Crane Less Counterweights and Track Frames	27,810 kg
Counterweight, 2 pieces 7,938 kg each	15,876 kg
Track Frames, 2 pieces 8,165 kg each	16,330 kg
Auxiliary Winch with Standard Rope	436 kg
Auxiliary Nose Sheave	95 kg
11t Headache Ball	200 kg
70t Hook Block	795 kg

## OPTIONAL EQUIPMENT

Alternative Boom 16,5 m three section boom in place of standard boom**	3,760 kg
9,1 m Lattice Extension	771 kg
6,1 m Jib (connects to head of Lattice Extension ONLY)	318 kg
Auger Ready Package	200 kg
Complete Auger Package	690 kg
1,5m Auger Kelly Bar	54 kg
1,8 m Auger Kelly Bar	64 kg
45t Hook Block	498 kg
Carbody Jacks	769 kg

\* Deduction from Standard Crane Weight

# GTC-700EX

70t Telescopic Boom Crawler Crane

SPECIFICATION SHEET NO. 415 - 03/13 ISO

## DIMENSIONS

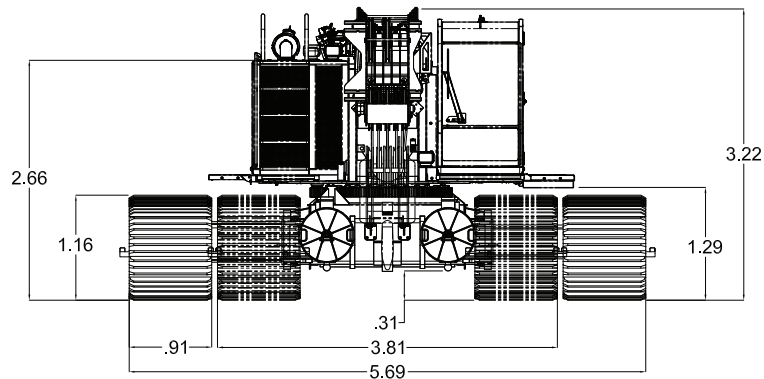
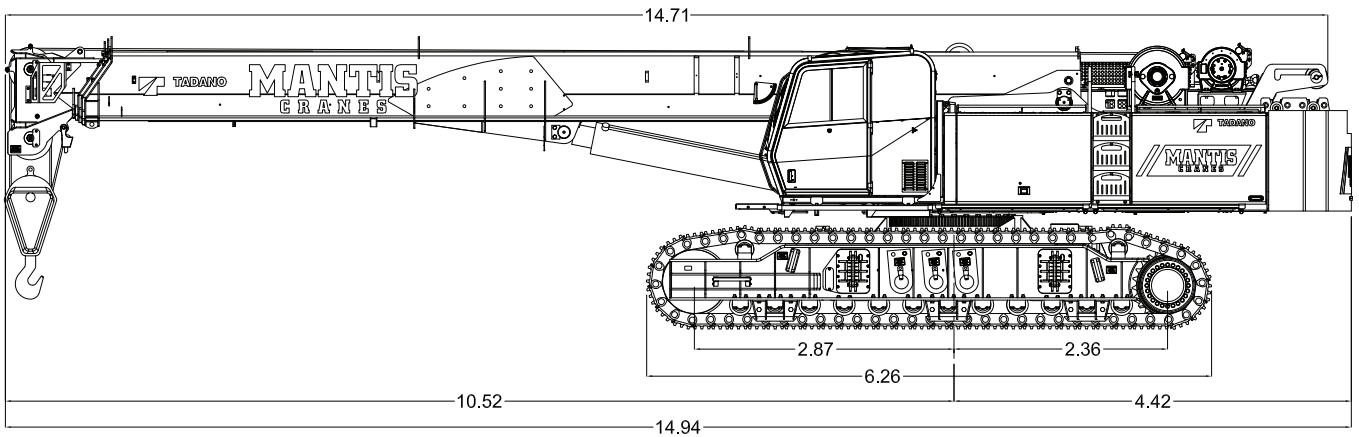

## TRANSPORT DIMENSIONS

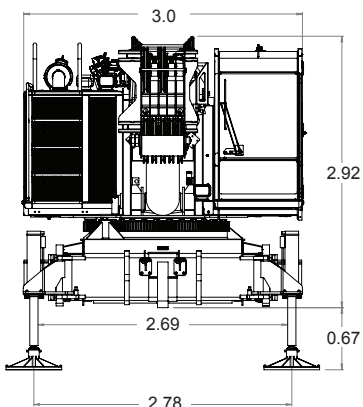
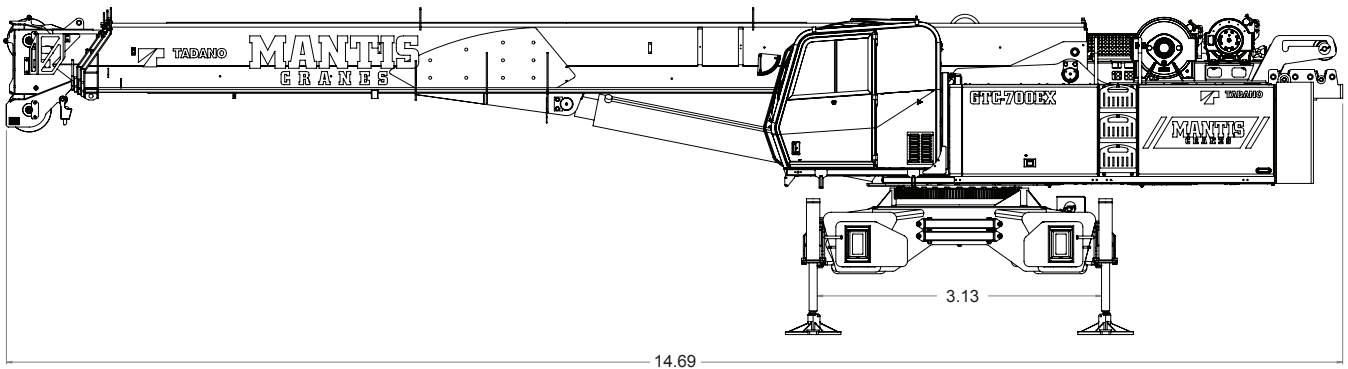

Superstructure Transport Weight: 29,015 kg  
(Standard crane with 4 section 34 m boom, Aux winch with wire rope, carbody jacks)

## TRANSPORT DIMENSIONS

Track Frames:  
2 Pieces: 8,165 kg each

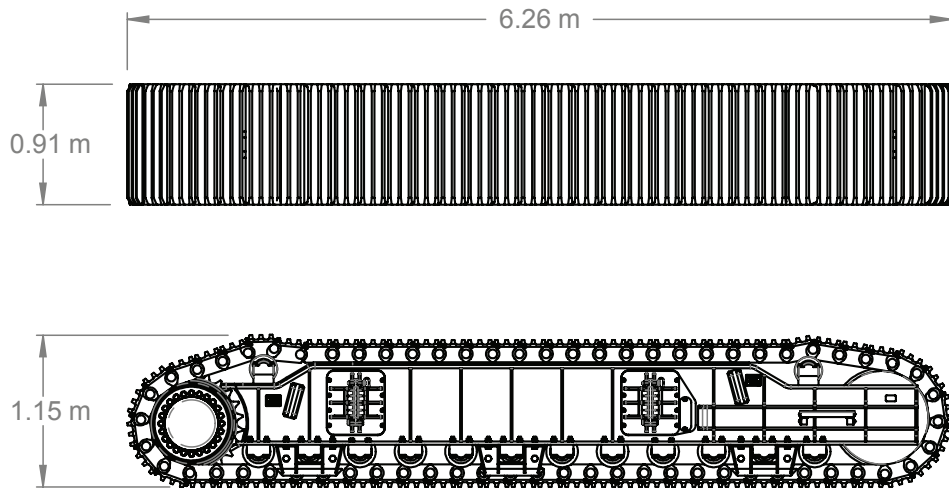

Front Counterweight:  
1 Piece: 7,938 kg

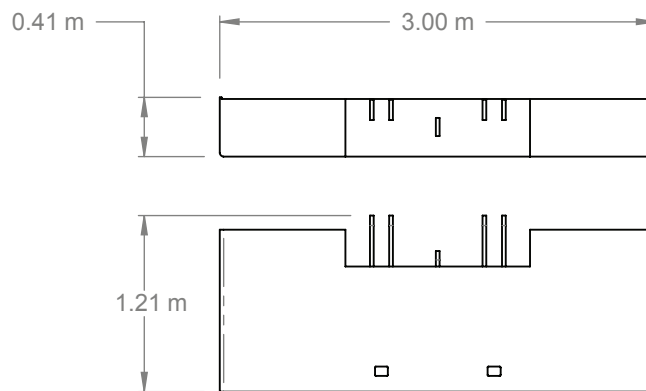

Back Counterweight  
1 Piece: 7,938 kg

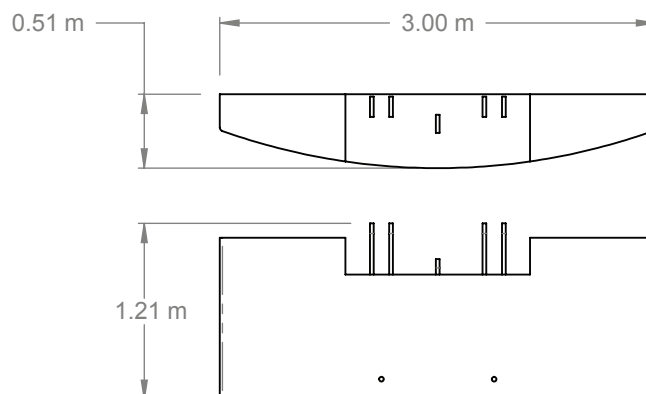

**34M MAIN BOOM, 9.1M EXTENSION & 6.1M JIB**

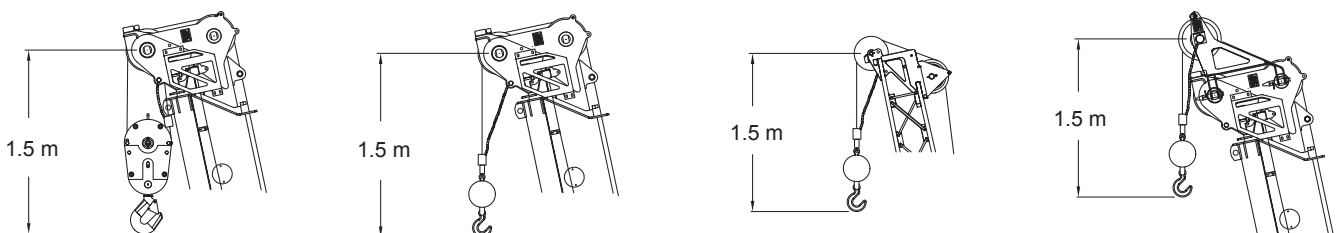
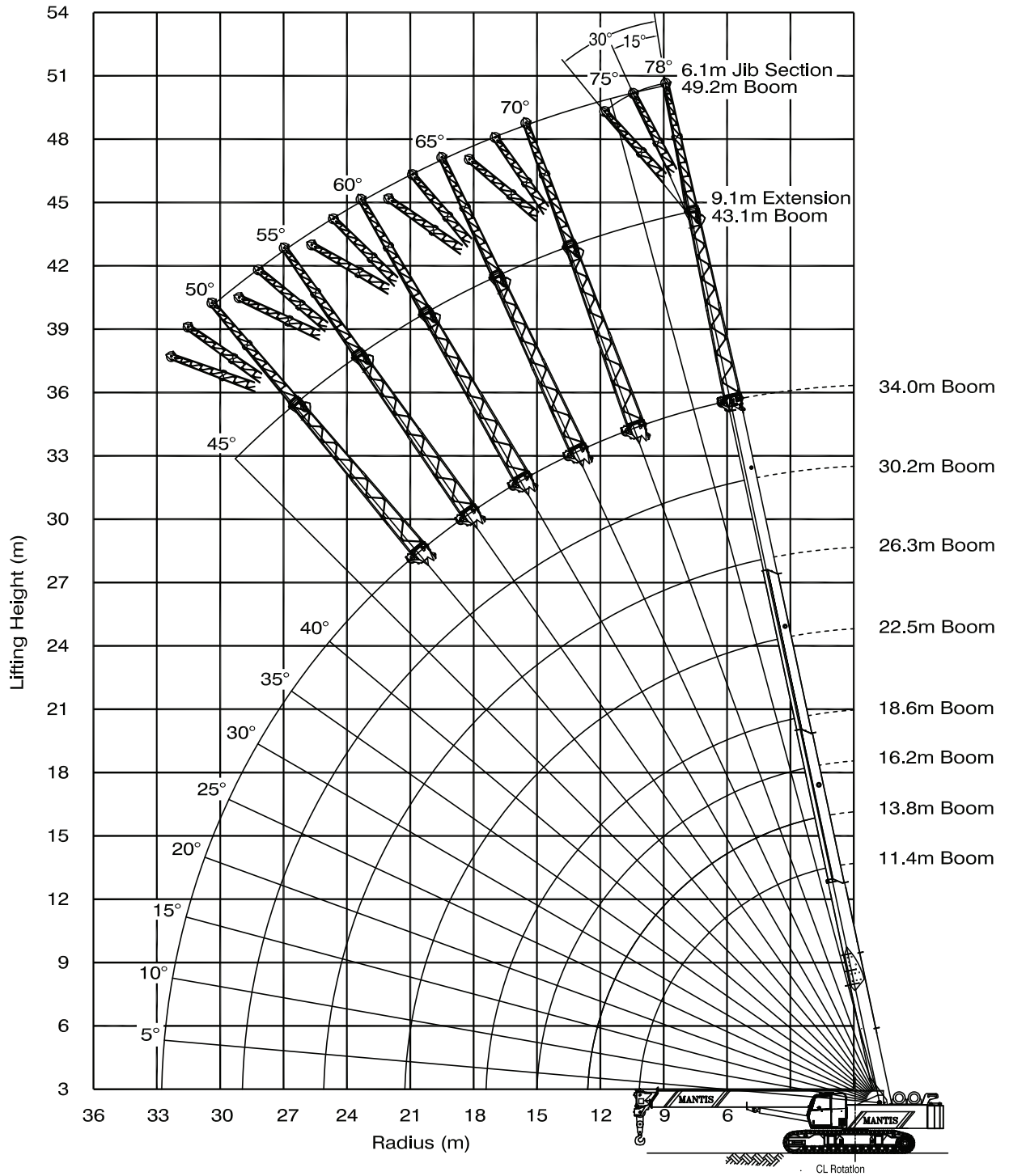



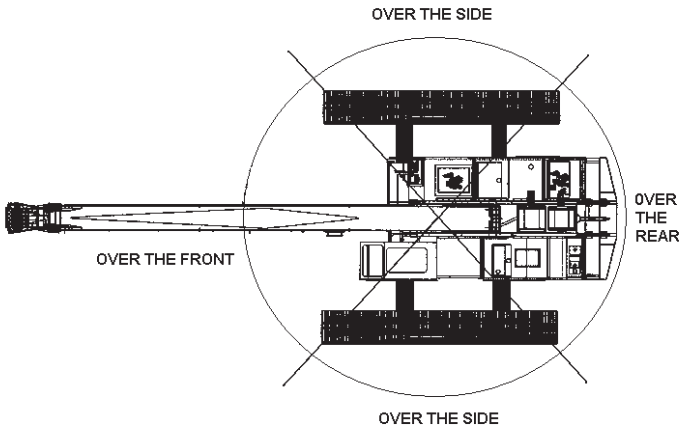

GTC-700EX				
WIRE ROPE LINE PULL CAPACITIES				
PARTS OF LINE	MAIN WINCH (kN)	AUX WINCH (kN)	PARTS OF LINE	MAIN WINCH (kN)
1	75,2	75,2	6	434,7
2	149,2	149,2	7	503,4
3	222,2	N/A	8	571,2
4	294,1	N/A	9	637,9
5	364,9	N/A	10	703,7

19mm diameter wire rope, Flex-X 35 Rotation Resistant

**PLEASE READ, UNDERSTAND, AND FOLLOW THE MANUALS FURNISHED WITH THE CRANE (OPERATOR'S AND SAFETY) AS WELL AS THE CAPACITY LIMITATIONS AND GENERAL CONDITIONS LISTED BELOW PRIOR TO OPERATION OF THE CRANE. FAILURE TO DO SO MAY RESULT IN AN ACCIDENT.**

### Capacity Limitations and General Conditions:

1. This TADANO MANTIS CRANE as manufactured meets the requirements of EN 13000. Structure and stability are tested in accordance with ISO 4310. Modifications to the crane or use of optional equipment other than specified by the manufacturer can result in a reduction of capacity.
2. All lifting capacities are determined by boom length and load radius.
3. Rated capacity loads given are maximum covered by the manufacturer's warranty and are based on a freely suspended load with NO allowance for factors such as out-of-level operation (beyond the limits specified on the charts), supporting surface conditions, hazardous surroundings, experience of personnel, etc. The operator shall establish practical working loads based on prevailing operating conditions, such as, but not limited to the above.
4. All rated capacity loads shown apply to original equipment as supplied by Tadano Mantis Corporation. Lifting capacities for the main boom apply to a crane with no boom extensions or accessories mounted on the crane.
5. Lifting capacities in the structural area are based on FEM/EN 13000.
6. Lifting capacities in the stability area are based on ISO 4305/EN 13000.
7. Maximum permissible wind speed for operation is 13 m/sec.
8. Boom positions without rated loads in the charts are prohibited. These areas are indicated by an "\*" and are susceptible to instability either in the forward direction or the backwards direction. Even without a load, the boom should not be positioned in these specific configurations of the load chart to avoid tipping the crane.
9. Deductions from rated capacities must be made for the weight of the hook block, headache ball, slings, spreader bar, and any other suspended equipment. See Lifting Capacity Deduction Chart for load handling devices supplied by Tadano Mantis Corporation
10. It is permissible to attempt to telescope boom with a load within the limits of rated capacities. However, boom telescope system hydraulic pressure, and/or boom lubrication may affect operation.
11. Side pull on boom is extremely dangerous and must be avoided.
12. **DO NOT** exceed manufacturers maximum specified reeving.
13. **DO NOT** lift load or extend boom without proper configuration of crane per load chart selected.
14. **Lifting capacities are subject to change without notice.**
15. **The above remarks are for information only. Always consult the operator's manual before operating this crane.**



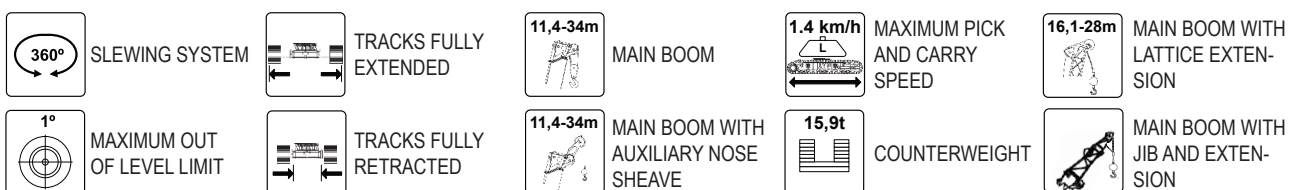

Load moment indicating and anti-two block systems are operator aids and must never be used in lieu of job site lift planning calculations by the operator which must take into account ground conditions, weather and all other environmental factors prevailing at the time of the lift. Prices and specifications are subject to change at any time without prior notice and are for factory installation at the time of original manufacture. F.O.B Plant; Richlands, VA 24641. Illustrations and photographs may show optional equipment. Supercedes all previous issues. Please see [www.mantiscranes.com](http://www.mantiscranes.com) for most current information.

### Load Chart Symbol Key

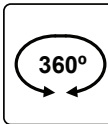

## LOAD CHARTS

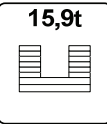
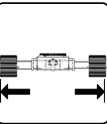

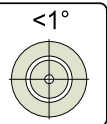

### LIFTING CAPACITIES - LOADS IN METRIC TON

m	      							
	11.4	13.8	16.2	18.6	22.5	26.3	30.2	34.0
3.0	70.0	48.8	47.6					
3.5	64.0	47.6	45.9	42.3				
4.0	58.1	46.8	44.3	39.5	29.5			
4.5	52.5	46.3	42.9	37.5	29.3			
5.0	47.6	43.6	40.7	35.4	28.6	23.4		
6.0	38.0	37.3	36.3	31.2	26.9	23.1	20.9	
7.0	33.0	31.1	30.6	28.4	24.3	20.7	18.8	16.3
8.0	26.3	26.2	25.7	24.6	22.2	18.5	16.9	15.8
9.0	21.6	21.5	21.3	21.0	20.6	16.9	15.3	14.3
10.0	18.1	18.0	17.9	17.7	17.9	16.1	14.0	13.0
11.0		15.4	15.2	15.1	15.7	15.2	12.8	11.7
12.0		13.3	13.1	13.0	13.6	13.7	11.8	10.6
13.0			11.4	11.3	11.8	12.1	11.2	10.2
14.0			10.0	9.9	10.4	10.7	10.7	9.7
15.0			8.8	8.7	9.2	9.5	9.8	9.1
16.0				7.7	8.2	8.5	8.8	8.5
17.0				6.8	7.3	7.6	7.9	7.9
18.0					6.6	6.8	7.1	7.2
19.0					5.9	6.2	6.4	6.5
20.0					5.3	5.6	5.8	5.9
21.0					4.8	5.0	5.3	5.3
22.0						4.5	4.8	4.8
23.0						4.1	4.4	4.4
24.0						3.7	4.0	4.0
25.0						3.3	3.6	3.7
26.0							3.3	3.3
27.0							3.0	3.0
28.0							2.7	2.7
29.0								2.5
30.0								2.2
31.0								2.0
32.0								1.8
<b>% Extension</b>								
<b>I</b>	0%	33%	67%	100%	100%	100%	100%	100%
<b>II</b>	0%	0%	0%	0%	25%	50%	75%	100%
<b>III</b>	0%	0%	0%	0%	25%	50%	75%	100%



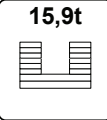
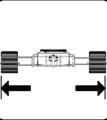

## LOAD CHARTS

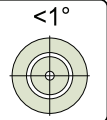
### LIFTING CAPACITIES - LOADS IN METRIC TON

      								
<b>MAIN BOOM - 15.9t COUNTERWEIGHT - TRACKS FULLY EXTENDED - TRAVEL TO 1.4 km/hr - LEVEL UP TO 1°</b>								
m	11.4	13.8	16.2	18.6	22.5	26.3	30.2	34.0
3.0	70.0	48.8	47.6					
3.5	64.0	47.6	45.9	42.3				
4.0	58.1	46.8	44.3	39.5	29.5			
4.5	52.5	46.3	42.9	37.5	29.3			
5.0	47.6	43.6	40.7	35.4	28.6	23.4		
6.0	38.0	37.3	36.3	31.2	26.9	23.1	20.9	
7.0	31.0	30.9	29.9	28.4	24.3	20.7	18.8	16.3
8.0	24.7	24.6	24.4	23.8	22.2	18.5	16.9	15.8
9.0	20.3	20.2	20.0	19.9	19.9	16.9	15.3	14.3
10.0	17.0	17.0	16.8	16.7	17.2	16.1	14.0	13.0
11.0		14.5	14.3	14.2	14.7	14.9	12.8	11.7
12.0		12.5	12.3	12.2	12.7	13.0	11.8	10.6
13.0			10.7	10.6	11.1	11.4	11.2	10.2
14.0			9.4	9.3	9.8	10.1	10.3	9.7
15.0			8.3	8.2	8.7	8.9	9.2	9.1
16.0				7.2	7.7	8.0	8.2	8.3
17.0				6.4	6.9	7.1	7.4	7.4
18.0					6.2	6.4	6.7	6.7
19.0					5.5	5.8	6.0	6.1
20.0					5.0	5.2	5.5	5.5
21.0					4.5	4.7	5.0	5.0
22.0						4.3	4.5	4.6
23.0						3.9	4.1	4.1
24.0						3.5	3.7	3.8
25.0						3.1	3.4	3.4
26.0							3.1	3.1
27.0							2.8	2.8
28.0							2.5	2.6
29.0								2.3
30.0								2.1
31.0								1.9
32.0								1.7
<b>% Extension</b>								
<b>I</b>	0%	33%	67%	100%	100%	100%	100%	100%
<b>II</b>	0%	0%	0%	0%	25%	50%	75%	100%
<b>III</b>	0%	0%	0%	0%	25%	50%	75%	100%

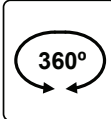

**LOAD CHARTS**

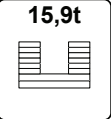
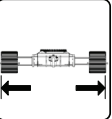
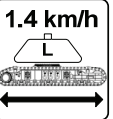
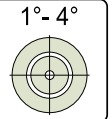
**LIFTING CAPACITIES - LOADS IN METRIC TON**

m	     							
	11.4	13.8	16.2	18.6	22.5	26.3	30.2	34.0
3.0	49.0	34.1	33.3					
3.5	44.8	33.3	32.2	29.6				
4.0	40.7	32.8	31.0	27.6	20.6			
4.5	36.8	32.4	30.0	26.2	20.5			
5.0	33.3	30.5	28.5	24.8	20.0	16.4		
6.0	26.6	26.1	25.4	21.9	18.8	16.2	14.6	
7.0	24.3	21.8	21.4	19.9	17.0	14.5	13.2	11.4
8.0	22.1	19.0	18.5	18.0	15.5	12.9	11.8	11.0
9.0	18.3	18.2	17.4	16.1	14.6	11.8	10.7	10.0
10.0	15.3	15.3	15.1	14.2	13.3	11.2	9.8	9.1
11.0		13.0	12.9	12.6	12.1	10.6	9.0	8.2
12.0		11.2	11.1	11.0	10.9	9.8	8.2	7.5
13.0			9.7	9.6	9.9	9.1	7.8	7.1
14.0			8.5	8.4	8.8	8.4	7.5	6.8
15.0			7.4	7.4	7.8	7.8	7.0	6.4
16.0				6.5	7.0	7.2	6.5	6.0
17.0				5.8	6.2	6.4	6.1	5.6
18.0					5.6	5.8	5.7	5.2
19.0					5.0	5.2	5.4	4.9
20.0					4.5	4.7	4.9	4.6
21.0					4.0	4.2	4.5	4.4
22.0						3.8	4.1	4.1
23.0						3.5	3.7	3.7
24.0						3.1	3.4	3.4
25.0						2.8	3.1	3.1
26.0							2.8	2.8
27.0							2.5	2.6
28.0							2.3	2.3
29.0								2.1
30.0								1.9
31.0								1.7
32.0								1.5
<b>% Extension</b>								
<b>I</b>	0%	33%	67%	100%	100%	100%	100%	100%
<b>II</b>	0%	0%	0%	0%	25%	50%	75%	100%
<b>III</b>	0%	0%	0%	0%	25%	50%	75%	100%

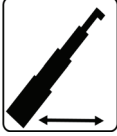
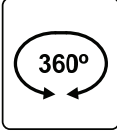

**LOAD CHARTS**

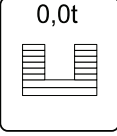
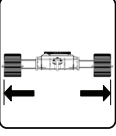
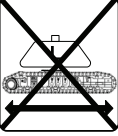
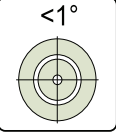
**LIFTING CAPACITIES - LOADS IN METRIC TON**

	     							
	<b>MAIN BOOM - 0t COUNTERWEIGHT - TRACKS FULLY EXTENDED - NO TRAVEL - LEVEL UP TO 1°</b>							
m	11.4	13.8	16.2	18.6	22.5	26.3	30.2	34.0
3.0	64.9	48.8	47.6					
3.5	51.2	46.3	42.3	38.8				
4.0	40.3	37.0	34.2	31.6	29.4			
4.5	33.0	30.5	28.4	26.5	25.0			
5.0	27.7	25.8	24.1	22.6	21.5	20.4		
6.0	20.5	19.3	18.2	17.1	16.6	15.9	15.4	
7.0	15.8	15.0	14.2	13.4	13.2	12.8	12.5	12.2
8.0	12.1	12.0	11.4	10.8	10.7	10.5	10.4	10.2
9.0	9.5	9.4	9.3	8.8	8.8	8.7	8.7	8.6
10.0	7.6	7.6	7.5	7.2	7.3	7.3	7.4	7.4
11.0		6.1	6.1	5.9	6.1	6.2	6.3	6.3
12.0		4.9	4.9	4.8	5.2	5.2	5.4	5.4
13.0			4.0	3.9	4.3	4.4	4.6	4.7
14.0			3.2	3.1	3.6	3.7	3.9	4.1
15.0			2.5	2.5	2.9	3.2	3.4	3.5
16.0				1.9	2.4	2.6	2.9	3.0
17.0				1.4	1.9	2.2	2.4	2.6
18.0					1.5	1.7	2.0	2.2
19.0					1.1	1.4	1.7	1.9
20.0					0.8	1.0	1.4	1.6
21.0					0.5	0.8	1.1	1.3
22.0						0.5	0.8	1.1
23.0						*	0.6	0.8
24.0						*	*	0.6
25.0						*	*	*
26.0							*	*
27.0							*	*
28.0							*	*
29.0								*
30.0								*
31.0								*
32.0								*
% Extension								
I	0%	33%	67%	100%	100%	100%	100%	100%
II	0%	0%	0%	0%	25%	50%	75%	100%
III	0%	0%	0%	0%	25%	50%	75%	100%

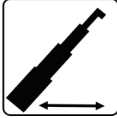
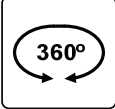

**LOAD CHARTS**

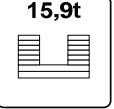
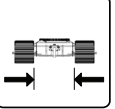
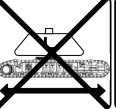
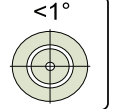
**LIFTING CAPACITIES - LOADS IN METRIC TON**

	     							
	<b>MAIN BOOM - 15.9t COUNTERWEIGHT - TRACKS RETRACTED - NO TRAVEL - LEVEL UP TO 1°</b>							
m	11.4	13.8	16.2	18.6	22.5	26.3	30.2	34.0
3.0	*	*	47.6					
3.5	52.7	47.6	45.4	42.3				
4.0	44.3	41.3	38.7	36.5	29.5			
4.5	38.1	35.6	33.6	31.8	29.3			
5.0	33.3	31.2	29.5	28.0	26.9	23.4		
6.0	26.4	24.8	23.5	22.4	21.8	21.1	20.4	
7.0	20.7	20.3	19.2	18.4	18.1	17.7	17.2	16.3
8.0	16.8	16.5	16.1	15.4	15.3	15.0	14.7	14.4
9.0	13.9	13.6	13.4	13.0	13.1	12.9	12.8	12.5
10.0	11.7	11.4	11.2	11.0	11.3	11.3	11.2	11.0
11.0		9.7	9.5	9.3	9.8	9.9	9.8	9.7
12.0		8.3	8.1	8.0	8.5	8.7	8.7	8.7
13.0			7.0	6.8	7.4	7.7	7.8	7.7
14.0			6.0	5.9	6.4	6.8	6.9	6.9
15.0			5.1	5.0	5.6	6.0	6.2	6.2
16.0				4.3	4.9	5.3	5.5	5.6
17.0				3.7	4.3	4.6	4.9	5.1
18.0					3.7	4.1	4.4	4.6
19.0					3.2	3.6	3.9	4.1
20.0					2.8	3.2	3.5	3.7
21.0					2.4	2.8	3.1	3.3
22.0						2.5	2.7	2.9
23.0						2.1	2.4	2.6
24.0						1.9	2.1	2.3
25.0						1.7	1.9	2.1
26.0							1.6	1.8
27.0							1.6	1.8
28.0							1.3	1.5
29.0								1.2
30.0								1.2
31.0								0.9
32.0								0.9
<b>% Extension</b>								
<b>I</b>	0%	33%	67%	100%	100%	100%	100%	100%
<b>II</b>	0%	0%	0%	0%	25%	50%	75%	100%
<b>III</b>	0%	0%	0%	0%	25%	50%	75%	100%



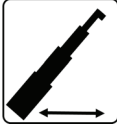
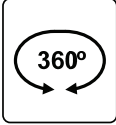

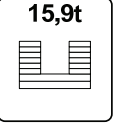
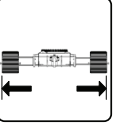
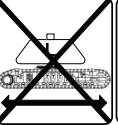
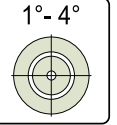
**LOAD CHARTS**

**LIFTING CAPACITIES - LOADS IN METRIC TON**

	     							
	<b>AUXILIARY BOOM HEAD - 15.9t COUNTERWEIGHT - TRACKS FULLY EXTENDED - NO TRAVEL - LEVEL 1° TO 4°</b>							
m	11.4	13.8	16.2	18.6	22.5	26.3	30.2	34.0
3.0	5.0	5.0	5.0					
3.5	5.0	5.0	5.0	5.0				
4.0	5.0	5.0	5.0	5.0	5.0			
4.5	5.0	5.0	5.0	5.0	5.0			
5.0	5.0	5.0	5.0	5.0	5.0	5.0		
6.0	5.0	5.0	5.0	5.0	5.0	5.0	5.0	
7.0	5.0	5.0	5.0	5.0	5.0	5.0	5.0	5.0
8.0	5.0	5.0	5.0	5.0	5.0	5.0	5.0	5.0
9.0	5.0	5.0	5.0	5.0	5.0	5.0	5.0	5.0
10.0	5.0	5.0	5.0	5.0	5.0	5.0	5.0	5.0
11.0		5.0	5.0	5.0	5.0	5.0	5.0	5.0
12.0		5.0	5.0	5.0	5.0	5.0	5.0	5.0
13.0			5.0	5.0	5.0	5.0	5.0	5.0
14.0			5.0	5.0	5.0	5.0	5.0	5.0
15.0			5.0	5.0	5.0	5.0	5.0	5.0
16.0				5.0	5.0	5.0	5.0	5.0
17.0				5.0	5.0	5.0	5.0	5.0
18.0					5.0	5.0	5.0	5.0
19.0					5.0	5.0	5.0	4.8
20.0					4.7	4.9	5.0	4.5
21.0					4.2	4.4	4.7	4.3
22.0						4.0	4.2	4.0
23.0						3.6	3.8	3.8
24.0						3.2	3.5	3.5
25.0						2.9	3.2	3.2
26.0							2.9	2.9
27.0							2.6	2.6
28.0							2.3	2.4
29.0								2.1
30.0								1.9
31.0								1.7
32.0								1.5
% Extension								
I	0%	33%	67%	100%	100%	100%	100%	100%
II	0%	0%	0%	0%	25%	50%	75%	100%
III	0%	0%	0%	0%	25%	50%	75%	100%

## LOAD CHARTS

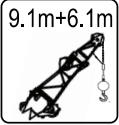
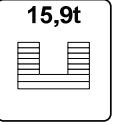
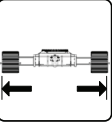
### LIFTING CAPACITIES - LOADS IN METRIC TON

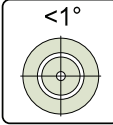
m	      											
	11.4			18.6			26.3			34.0		
	0°	15°	30°	0°	15°	30°	0°	15°	30°	0°	15°	30°
5.0	3.0											
6.0	2.9											
7.0	2.6	1.8		3.0								
8.0	2.4	1.7	1.0	2.9	1.8		3.0					
9.0	2.1	1.6	1.0	2.6	1.8	1.0	2.9					
10.0	2.0	1.5	0.9	2.4	1.7	1.0	2.9	1.8		3.0		
11.0	1.9	1.4	0.9	2.3	1.6	1.0	2.7	1.8	1.0	2.9	1.8	
12.0	1.7	1.3	0.8	2.1	1.5	0.9	2.5	1.7	1.0	2.9	1.8	
13.0	1.5	1.2	0.8	2.0	1.4	0.9	2.3	1.6	1.0	2.7	1.8	1.0
14.0	1.3	1.0	0.8	1.9	1.4	0.8	2.2	1.6	0.9	2.6	1.7	1.0
15.0	1.0	0.8	0.7	1.8	1.3	0.8	2.1	1.5	0.9	2.4	1.7	1.0
16.0	0.7	0.5	0.5	1.6	1.2	0.8	2.0	1.4	0.9	2.3	1.6	0.9
17.0		0.2	0.3	1.5	1.1	0.8	1.9	1.4	0.8	2.2	1.5	0.9
18.0			0.1	1.3	1.0	0.8	1.8	1.3	0.8	2.1	1.5	0.9
19.0				1.1	0.8	0.6	1.7	1.2	0.8	2.0	1.4	0.9
20.0				0.9	0.5	0.5	1.6	1.2	0.8	1.9	1.4	0.8
21.0					0.3	0.4	1.5	1.1	0.8	1.9	1.3	0.8
22.0						0.2	1.3	0.9	0.8	1.8	1.3	0.8
23.0							1.2	0.8	0.6	1.7	1.2	0.8
24.0							1.0	0.6	0.6	1.6	1.2	0.8
25.0							0.8	0.4	0.5	1.5	1.1	0.8
26.0								0.3	0.3	1.4	1.0	0.7
27.0									0.2	1.2	0.8	0.6
28.0										1.1	0.7	0.6
29.0										1.0	0.5	0.5
30.0										0.8	0.4	0.4
31.0											0.2	0.2
32.0											0.1	0.1
% Extension												
I	0%			100%			100%			100%		
II	0%			0%			50%			100%		
III	0%			0%			50%			100%		



# **GTC-700EX**

70t Telescopic Boom Crawler Crane

SPECIFICATION SHEET NO. 415 - 03/13 ISO

---

## **NOTES:**

# TADANO MANTIS CORPORATION

1705 Columbia Avenue • Franklin, TN 37064 USA • Toll-Free: 1-800-272-3325 • Fax: 615-790-6803 • [mantiscranes.com](http://mantiscranes.com)

## **TADANO Ltd., International Division**

4-12, Kamezawa 2-chome,  
Sumida-Ku, Tokyo 130-0014, Japan  
Tel: +81 3 3621 7750  
Fax: +81 3 3621 7785  
E-mail: [tdnihq@tadano.co.jp](mailto:tdnihq@tadano.co.jp)  
<http://www.tadano-global.com>

SPECIFICATION SHEET NO. 415 - 03/13 ISO