

60 t
A600



SPECIFICHE TECNICHE

PRESTAZIONI DELLA GRU

Portata a 3 m da asse ralla.	60 t
Lunghezza braccio (chiuso / aperto).	10.3 / 32.4 m
Altezza testa braccio.	35.3 m

PRESTAZIONI DEL CARRO ⁽¹⁾

Velocità massima di traslazione con pneumatici 23.5R25. <small>(La velocità di traslazione è costruttivamente limitata a 15 Km/h per la circolazione su strade pubbliche).</small>	29 km/h
Velocità massima di traslazione con pneumatici 26.5R25. <small>(Versione non omologata per la circolazione su strade pubbliche).</small>	30 km/h
Rampa massima teorica in condizioni di marcia con pneumatici 23.5R25.	152 %
Rampa massima teorica in condizioni di marcia con pneumatici 26.5R25.	122 %

(1) Gru in versione standard ed in condizioni di marcia: senza argano ausiliario, senza prolunghe.

MASSE ⁽²⁾

I° assale	II° assale	Totale
18.4 t	22.1 t	40.5 t

(2) Gru in versione standard: senza argano ausiliario, senza prolunghe, con pneumatici 23.5R25.

VELOCITÀ / TEMPI DI LAVORO ⁽³⁾

Argano principale (massima in tiro diretto).	60 m/min
Argano ausiliario (massima in tiro diretto).	80 m/min
Sollevamento / Discesa braccio telescopico.	50 / 50 s
Sfilo / Rientro braccio telescopico (da 10.3 m a 32.4 m).	100 / 80 s
Rotazione sovrastruttura.	30 s
Sfilo singola traversa porta-stabilizzatori.	6 s
Sfilo completo singolo stabilizzatore.	20 s

(3) Valori medi di riferimento misurati a 2000 giri/min motore e forniti a puro titolo indicativo

CARRO

Trazione/Sterzo	4x4x4
Telaio	A doppio longherone a cassone. Punto di traino anteriore (in opzione anche posteriore).
Stabilizzatori	n. 4 idraulici indipendenti installati su travi sfilabili idraulicamente. Stabilizzazione con travi parzialmente o completamente estese. Azionamento dalla cabina di guida.
Motore	CUMMINS QSB6.7: 6 cilindri in linea - Cilindrata 6.70 dm ³ - Raffreddato ad acqua con intercooler - Turbocompresso - Common rail Potenza massima 149 kW a 2100 giri/min - Coppia massima 742 Nm a 1500 giri/min. Certificazione 2004/26/CE Fase IIIA.
Serbatoio	300 l.
Trasmissione	DANA serie 32000: Tipo powershift con convertitore di coppia. 3+3 marce avanti e 3+3 retromarce con selezione di gamma lenta e veloce. Inserimento automatico della trazione integrale selezionando la gamma lenta.
Freni	Servizio: a doppio circuito a tamburo su tutte le ruote ad azionamento pneumatico. Stazionamento / Emergenza: negativo su tutte le ruote del tipo a molla con azionamento pneumatico.
Assali	n. 2 assali motori e sterzanti con riduttori epicicloidali nei mozzi. Blocco del differenziale posteriore (solo selezionando la modalità a 4 ruote motrici).
Sospensioni	Rigida su assale anteriore, oscillazione dell'assale posteriore. Blocco automatico dell'oscillazione posteriore mediante martinetti idraulici quando il braccio di sollevamento non è nel settore anteriore della gru allineato sull'asse di mezzzeria. Possibilità di blocco manuale dalla cabina dell'oscillazione posteriore.
Sterzo	Idrostatico mediante volante in cabina di guida. Possibilità di sterzata del solo assale anteriore o di entrambi in modalità concentrica o a granchio
Pneumatici	n. 4 pneumatici 23.5R25 tubeless. In opzione n. 4 pneumatici 26.5R25 (26.5-25) tubeless.

SOVRASTRUTTURA

Braccio	n. 4 elementi a sezione ottagonale.
Sollevamento	n. 1 martinetto idraulico a doppio effetto. Possibilità di inclinazione del braccio da -3° a $+80^{\circ}$
Sfilo	L'elemento 2 è sfilato in modo indipendente rispetto ai rimanenti mediante un martinetto idraulico a doppio effetto. Gli elementi 3 e 4 sono sfilati in modo proporzionale e continuo mediante un martinetto idraulico a doppio effetto ed un sistema interno di rinvio a catene. Possibilità di sfilo sotto carico parziale.
Argano	Azionato da motore idraulico a pistoni assiali a doppia cilindrata con riduttore epicicloidale. Freno negativo sulla discesa ad inserimento automatico. Dispositivo pressafune. Doppia velocità di rotazione. Fune diametro 18 mm lunghezza 200 m. Capacità massima di sollevamento 5300 daN. In opzione argano ausiliario azionato da motore idraulico a pistoni assiali a cilindrata fissa con riduttore epicicloidale. Freno negativo sulla discesa ad inserimento automatico. Dispositivo pressafune. Doppia velocità di rotazione. Fune diametro 15 mm lunghezza 150 m. Capacità massima di sollevamento 3800 daN.
Rotazione	Continua su 360° mediante motore idraulico e riduttore epicicloidale su ralla a doppio giro di sfere con dentatura interna. Freno negativo ad inserimento automatico. Comando di sblocco del freno per l'allineamento diretto del braccio sulla verticale del carico da sollevare.
Cabina	Ad ampia visibilità con sportello scorrevole. Dotata di riscaldamento. Vetro anteriore e superiore con tergicristallo. Vetro superiore e posteriore apribili. Sedgiolino completamente regolabile su sospensioni anti-shock, dotato di braccioli sollevabili che integrano i manipolatori per il comando dei vari movimenti della gru.
Sicurezza	Valvole di blocco sui martinetti di sfilo e sollevamento braccio e sugli stabilizzatori. Valvole di massima pressione su ogni circuito idraulico. Valvola di bilanciamento e frenatura su gruppo rotazione. Valvola di bilanciamento e frenatura sull'argano. Interruttore di fine corsa su testa braccio per la salita del bozzello. Interruttore di fine corsa per conservare tre giri di avvolgimento fune sull'argano. Dispositivo limitatore di carico con indicazione: <ul style="list-style-type: none">Inclinazione braccioLunghezza braccioCarico sollevatoMassimo carico sollevabile Possibilità di impostare la limitazione dei movimenti del braccio telescopico.

IMPIANTI

Idraulico	Alimentazione: n. 1 pompa doppia ad ingranaggi, n. 1 pompa doppia ad ingranaggi e n. 1 pompa ad ingranaggi. Controllo movimenti: distributori azionati da manipolatori idraulici con possibilità di manovre simultanee e proporzionali. Controllo stabilizzatori: elettrovalvole azionate da pulsanti indipendenti. Filtraggio: n. 2 filtri a cartuccia sul circuito di ritorno. Scambiatore di calore per il raffreddamento dell'olio.
Elettrico	A 24 V con alternatore da 70 A e n. 2 batterie da 132 Ah. Dispositivi di illuminazione conformi alle direttive dell'Unione Europea.
Pneumatico	Compressore da 247 cm ³ , n. 2 serbatoi da 45 l ciascuno e dispositivo essiccatore. Presa d'aria ausiliaria e kit di gonfiaggio pneumatici.

OPZIONALI PRINCIPALI

Puleggia supplementare su testa braccio
Jib ad "A" da 1,65 m
Prolunga tralicciata da 0.7 + 7.3 m
Prolunga tralicciata da 0.7 + 7.3 + 6 m
Prolunga tralicciata da 0.7 + 7.3 + 6 + 6 m
Impianto condizionatore caldo/freddo in cabina
Kit avviamento motore basse temperature
Argano ausiliario
Bozzello da 12,5 T
Gancio da 8 T
Bozzello da 10 T per argano ausiliario
Gancio da 5 T per argano ausiliario

Riferirsi al dealer di zona per un elenco completo degli opzionali.

SPECIFICATIONS

CRANE PERFORMANCE DATA

Capacity at 3 m from slewing axis.	60 t
Boom length (retracted / extended).	10.3 / 32.4 m
Boom head height.	35.3 m

TRUCK PERFORMANCE DATA ⁽¹⁾

Max. travelling speed on 23.5R25 tyres.	29 km/h
Max. travelling speed on 26.5R25 tyres.	30 km/h
Max. theoretical ramp during operation (on 23.5R25 tyres).	152 %
Max. theoretical ramp during operation (on 26.5R25 tyres).	122 %

(1) Gru in versione standard ed in condizioni di marcia: senza argano ausiliario, senza prolunghie.

WEIGHTS ⁽²⁾

1 st axle	2 nd axle	Total
18.4 t	22.1 t	40.5 t

(2) Standard crane: no auxiliary winch and no extensions, on 23.5R25 tyres.

OPERATING SPEED / TIMES ⁽³⁾

Main winch (max. speed under direct pull).	60 m/min
Auxiliary winch (max. speed under direct pull).	80 m/min
Telescopic boom lifting / lowering.	50 / 50 s
Telescopic boom extension / retraction (10.3 m to 32.4 m).	100 / 80 s
Upper structure slewing.	30 s
Extension of single outrigger beam.	6 s
Extension of single outrigger.	20 s

(3) Average reference indicative values measured at 2000 rpm of engine

TRUCK

Traction/Steering	4x4x4.
Frame	With twin body side member. Front tow point (back tow point on request).
Outriggers	no. 4 independent hydraulic outriggers onto hydraulic beams. Outrigger beams can be partially or fully extended. Outrigger controls in the operating cab.
Engine	CUMMINS QSB6.7: no. 6 in-line cylinders - displacement 6.70 cu dm - water cooling with intercooler - turbo supercharger - Common rail Max. power 149 kW at 2100 rpm - Max. torque 742 Nm at 1500 rpm. - 2004/26/CE Step IIIA approved.
Tank	300 l.
Transmission	DANA series 32000: Powershift-type transmission with torque converter. 3 + 3 forward speeds and 3 + 3 reverse speed: slow and fast speed mode. Automatic engagement of 4WD after selecting slow speed mode.
Brakes	Service brake: air-operated drum brakes with split circuit system on all wheels. Parking / emergency brake: spring-set air-operated negative brake on all wheels
Axles	no. 2 driving / steering axles equipped with planetary gearboxes into hubs. Rear differential lock (selectable only in 4WD mode).
Suspension	Stiff suspension for front axle, swinging suspension for rear axle. Rear suspension is automatically locked by hydraulic jacks if lifting boom is not aligned with centreline within front crane area. Manual stop for rear suspension locking in operating cab.
Steering	Hydrostatic steering controlled by steering wheel into the operating cab. Steering of front axle alone or both axles in concentric or crab mode.
Tyres	no. 4 23.5R25 tubeless tyres. On request, no. 4 26.5R25 (26.5-25) tubeless tyres.

UPPER STRUCTURE

Boom	no. 4 octagonal elements.
Lifting	no. 1 double action hydraulic jack. Boom inclination: -3° to $+80^{\circ}$.
Extension	Separate extension of element 2 through double action hydraulic jack. Continuous proportional extension of elements 3 and 4 through double action hydraulic jack and inner chain-driven system. Extension under partial load possible.
Winch	Controlled by double displacement hydraulic motor equipped with axial pistons and planetary gearbox. Automatic negative brake for winch lowering. Cable tensioner. Two different rotation speeds. Rope diameter 18 mm length 200 m. Max. lifting capacity 5300 daN. On request, auxiliary winch controlled by hydraulic motor equipped with axial pistons and planetary gearbox. Automatic negative brake for winch lowering. Rope clamp. Two different rotation speeds. Rope diameter 15 mm length 150 m. Max. lifting capacity 3800 daN.
Slewing	360° non-stop rotation controlled by hydraulic motor equipped with planetary gearbox on slewing ring having double ball ring and inner toothing. Automatic negative brake. Brake release for direct alignment of boom along load vertical line.
Operating cab	Sliding door. Wide visibility. Equipped with heating system. Front and upper window with windscreen wiper. Upper and back windows can be opened. Fully adjustable seat onto shockproof suspensions. Equipped with tiltable arm rests with integrated hand controls for crane operation.
Safety	Stop valves onto extension / lifting boom jacks and outriggers. Max. pressure valves for each hydraulic circuit. Balancing braking valve for the slewing unit. Balancing braking valve for the winch. Limit switch onto boom head for hoisting block lift. Limit switch for having three winding turns around the winch. Load limiting device with indicator for: <ul style="list-style-type: none"> Boom inclination Boom length Load weight Max. load which can be lifted Telescopic boom movement limit can be set.

SYSTEMS

Hydraulic system	Feeding: no. 1 double gear pump, no. 1 double gear pump and no. 1 gear pump. Movement control: distributors controlled by hydraulic hand controls. More proportional operations can be carried out at the same time. Outrigger control: solenoid valves controlled by separate buttons. Filtering: no. 2 cartridge filters in return circuit. Heat exchanger for oil cooling-down
Electric system	24 V, 70 A generator and no. 2 132 Ah batteries. Lighting devices in compliance with current EU directives.
Pneumatic system	247 cu cm compressor, no. 2 45 l reservoirs and drier. Auxiliary air intake and tyre inflating kit

MAIN OPTIONS

Additional pulley onto boom head
"A" jib 1.65 m long
Lattice extension 0.7 m + 7.3 m long
Lattice extension 0.7 m + 7.3 m + 6 m long
Lattice extension 0.7 m + 7.3 m + 6 m + 6 m long
Air conditioning / heating system into operating cab
Cold engine starting kit
Auxiliary winch
12,5 t hook block
8 t hook
10 t hook block for auxiliary winch
5 t hook for auxiliary winch

Refer to your local dealer for a complete list of available options.

CARACTÉRISTIQUES

PERFORMANCES DE LA GRUE

Capacité à 3 m depuis l'axe crapaudine.	60 t
Longueur flèche (ouverte / fermée).	10.3 / 32.4 m
Hauteur tête flèche.	35.3 m

PERFORMANCES DU CHASSIS ⁽¹⁾

Vitesse maximum de translation avec pneus 23.5R25.	29 km/h
Vitesse maximum de translation avec pneus 26.5R25.	30 km/h
Rampe maximum théorique en conditions de marche avec pneus 23.5R25.	152 %
Rampe maximum théorique en conditions de marche avec pneus 26.5R25.	122 %

(1) Grue en version standard et en conditions de marche : sans treuil auxiliaire, sans extension

MASSES ⁽²⁾

I ^o essieu	II ^o essieu	Total
18.4 t	22.1 t	40.5 t

(2) Grue en version standard : sans treuil auxiliaire, sans extension, avec pneus 23.5R25

VITESSE/ TEMPS DE FONCTIONNEMENT ⁽³⁾

Treuil principal (maximum en tirage direct).	60 m/min
Treuil auxiliaire (maximum en tirage direct).	80 m/min
Relevage / Descente flèche télescopique.	50 / 50 s
Télescopage flèche (de 10.3 m à 32.4 m).	100 / 80 s
Orientation partie tournante.	30 s
Télescopage traverse simple porte-stabilisateurs.	6 s
Télescopage complet simple stabilisateur.	20 s

(3) Valeurs moyennes de référence mesurées à 2000 tr/min moteur et fournies à titre purement indicatif

CHÂSSIS

Traction/Braquage	4x4x4.
Structure	A double longeron à caisson. Point de traction avant (arrière en option).
Stabilisateurs	n. 4 hydrauliques indépendants installés sur traverses à télescopage hydraulique. Stabilisation avec traverses en extension partielle ou en extension complète. Actionnement depuis la cabine de conduite.
Moteur	CUMMINS QSB6.7: 6 cylindres en ligne - Cylindrée 6.70 dm ³ - Refroidi à l'eau avec intercooler - Turbocompressé - Common rail Puissance maximum 149 kW à 2100 tours/min - Couple maximum 742 Nm à 1500 tours/min. Certification 2004/26/CE Phase IIIA.
Réservoir	300 l.
Transmission	DANA série 32000: Type powershift avec convertisseur de couple. 3+3 marches avant et 3+3 marches arrière avec sélection de gamme lente et rapide. Enclenchement automatique de la traction intégrale en sélectionnant la gamme lente.
Freins	En fonctionnement : type à tambour et double circuit sur toutes les roues à actionnement pneumatique. En stationnement / Urgence : type de maintien à ressort sur toutes les roues, à actionnement pneumatique.
Essieux	n. 2 essieux moteurs et de braquage avec réducteurs épicycloïdaux dans les moyeux. Blocage du différentiel arrière uniquement en sélectionnant le mode à 4 roues motrices.
Suspensions	Rigide sur l'essieu avant, oscillation de l'essieu arrière. Blocage automatique de l'oscillation arrière au moyen de vérins hydrauliques lorsque la flèche de levage n'est pas dans la zone avant de la grue et alignée sur l'axe de moitié. Possibilité de blocage manuel de l'oscillation arrière depuis la cabine.
Braquage	Hydrostatique depuis volant dans la cabine de conduite. Possibilité de braquage uniquement de l'essieu avant ou des deux essieux en mode concentrique ou en crabe.
Pneus	n. 4 pneus 23.5R25 tubeless. En option n. 4 pneus 26.5R25 (26.5-25) tubeless.

PARTIE TOURNANTE

Flèche	n. 4 éléments à section octogonale.
Relevage	n. 1 vérin hydraulique à double effet. Possibilité d'inclinaison du bras de -3° à $+80^{\circ}$.
Télescopage	L'élément 2 est télescopé indépendamment des autres au moyen d'un vérin hydraulique à double effet. Les éléments 3 et 4 sont télescopés de façon proportionnelle et continue au moyen d'un vérin hydraulique à double effet et d'un système interne de renvoi à chaînes. Possibilité de télescopage sous charge partielle.
Treuil	Actionné par un moteur hydraulique à pistons axiaux à double cylindrée avec réducteur épicycloïdal. Frein négatif sur la descente à enclenchement automatique. Dispositif serre-câble. Double vitesse de rotation. Câble diamètre 18 mm longueur 200 m. Capacité maximum de levage 5300 daN. En option treuil auxiliaire actionné par un moteur hydraulique à pistons axiaux à cylindrée fixe avec réducteur épicycloïdal. Frein négatif à enclenchement automatique sur la descente. Dispositif serre-câble. Double vitesse de rotation. Câble diamètre 15 mm longueur 150 m. Capacité maximum de levage 3800 daN.
Orientation	Continue sur 360° au moyen d'un moteur hydraulique et d'un réducteur épicycloïdal sur couronne d'orientation à double tour de billes avec denture interne. Frein négatif à enclenchement automatique. Commande de déblocage du frein pour l'alignement direct de la flèche à la verticale de la charge à lever.
Cabine	A large visibilité avec porte coulissante. Dotée de chauffage. Vitres avant et supérieure avec essuie-glaces. Vitres supérieure et arrière ouvrables. Siège entièrement réglable sur suspension antichoc, doté d'accoudoirs relevables comprenant les manipulateurs pour la commande des différents mouvements de la grue.
Sécurité	Vannes de blocage sur les vérins de télescopage et levage flèche ainsi que sur les stabilisateurs. Soupapes de pression maximum sur chaque circuit hydraulique. Vanne d'équilibrage et de freinage sur le groupe d'orientation. Vanne d'équilibrage et de freinage sur le treuil. Interrupteur de fin de course sur tête flèche pour la montée de la moufle. Interrupteur de fin de course pour conserver trois tours d'enroulement câble sur le treuil. Limiteur de charge avec indication : <ul style="list-style-type: none">Inclinaison flècheLongueur flècheCharge levéeCharge maximum levable Possibilité de programmer la limitation des mouvements du bras télescopique.

CIRCUITS

Hydraulique	Alimentation: n. 1 pompe double à engrenages, n. 1 pompe double à engrenages, n. 1 pompe à engrenages. Contrôles mouvements: distributeurs actionnés par des manipulateurs hydrauliques avec possibilité de manœuvres simultanées proportionnelles. Contrôle stabilisateurs: électrovannes actionnées par des poussoirs indépendants. Filtrage: n. 2 filtres à cartouche sur le circuit de retour. Echangeur de chaleur pour le refroidissement de l'huile.
Electrique	à 24 V avec alternateur de 70 A et n. 2 batteries de 132 Ah. Dispositifs d'éclairage conformes aux directives de l'Union Européenne.
Pneumatique	Compresseur de 247 cm ³ , n. 2 réservoirs de 45 l chacun et dispositif de séchage. Prise d'air auxiliaire et kit de gonflage des pneus.

OPTIONS PRINCIPALES

Poulie supplémentaire sur tête flèche
Jib en "A" de 1,65 m
Extension treillis de 0.7 + 7.3 m
Extension treillis de 0.7 + 7.3 + 6 m
Extension treillis de 0.7 + 7.3 + 6 + 6 m
Groupe de climatisation chaud / froid dans la cabine de conduite
Kit démarrage à froid moteur
Treuil auxiliaire
12,5 t moufle
Crochet 8 t
10 t moufle pour treuil auxiliaire
Crochet 5 t pour treuil auxiliaire

Se référer au concessionnaire local pour une liste complète des options.

TECHNISCHE DATEN

EIGENSCHAFTEN DES KRANS

Tragfähigkeit bei 3 m ab Drehplatte. Auslegerlänger (eingefahren / ausgefahren). Auslegerkopfhöhe.	60 t 10.3 / 32.4 m 35.3 m
--	---------------------------------

EIGENSCHAFTEN DES WAGENS ⁽¹⁾

Höchstgeschwindigkeit mit 23.5R25-Reifen.	29 km/h
Höchstgeschwindigkeit mit 26.5R25-Reifen.	30 km/h
Höchstsollrampe bei Fahrt mit 23.5R25-Reifen.	152 %
Höchstsollrampe bei Fahrt mit 26.5R25-Reifen.	122 %

(1) Kran in Standardausführung und bei Betrieb: ohne Zusatzwinde und ohne Auslegerverlängerungen

GEWICHT ⁽²⁾

I° achse	II° achse	Gesamt
18.4 t	22.1 t	40.5 t

(2) Kran in Standardausführung: ohne Zusatzwinde und ohne Auslegerverlängerungen, mit 23.5R25-Reifen

BETRIEBSGESCHWINDIGKEIT / -ZEITEN ⁽³⁾

Hauptwinde (Höchstgeschwindigkeit bei direktem Zug).	60 m/min
Zusatzwinde (Höchstgeschwindigkeit bei direktem Zug).	80 m/min
Heben / Senken des Teleskopauslegers.	50 / 50 s
Ausfahren / Einfahren des Teleskopauslegers (von 10.3 m bis 32.4 m).	100 / 80 s
Schwenken des Oberwagens.	30 s
Ausfahren eines Stützauslegerträgers.	6 s
Vollständiges Ausfahren eines Stützauslegers.	20 s

(3) Durchschnittliche Bezugswerte, die bei einer Motordrehzahl von 2000/min gemessen wurden und die als reine Anhaltswerte angegeben werden

WAGEN

Antrieb/Lenkung	4x4x4.
Rahmen	Rahmen mit zwei Kastenlängsträgern. Befestigungspunkt vorne (optional auch hinten).
Stützausleger	4 hydraulische unabhängige auf hydraulisch ausfahrbaren Trägern angebrachte Stützausleger. Stützung bei und vollkommen oder teilweise ausgefahrenen Trägern. Steuerung von der Fahrerkabine.
Motor	CUMMINS QSB6.7: Reihenmotor mit 6 Zylindern - Hubraum 6.70 dm ³ - mit Intercooler-Wasserkühlung - Turbokompressor - Common rail Höchstleistung 149 kW bei 2100 U/min - maximales Drehmoment 742 Nm bei 1500 U/min. Zertifizierung: 2004/26/EG Stufe IIIA.
Behälter	300 l.
Antrieb	DANA-32000: Powershift mit Drehmomentwandler. 3+3 Vorwärtsgänge und 3+3 Rückgänge mit Gangwahl langsam/schnell. Automatischer Vollantrieb in den langsamen Gängen.
Bremssystem	Betrieb: mit Doppel-Trommelsteuerung auf allen Rädern mit Druckluftantrieb. Feststellbremse / Notbremse: negativ auf allen Rädern des Federtyps mit Druckluftantrieb.
Achsen	2 Trieb- und Lenkachsen mit Planetenumsetzungsgetrieben an den Naben. Differentialsperre hinten (nur bei Allradantrieb).
Aufhängung	Starre Vorderachsenaufhängung, hintere Schwenkachse. Automatische Sperrung der hinteren Schwenkbewegung anhand hydraulischer Hebeböcke wenn sich der Hebeam nicht im Vorderbereich des auf der Mittelachse ausgerichteten Krans befindet. Die hintere Schwenkung kann von der Fahrerkabine aus manuell gesperrt werden.
Lenkung	Hydrostatische Lenkung über Lenkrad in der Fahrerkabine. Vorderachsenlenkung oder konzentrische bzw. Krabben-Vollachsenlenkung
Bereifung	4 schlauchlose 23.5R25-Reifen. Optional 4 schlauchlose 26.5R25 (26.5-25) - Reifen.

OBERWAGEN	
Ausleger	4 Elemente mit achteckigem Querschnitt.
Heben	1 hydraulischer Hebebock mit Doppelwirkung. Neigung des Auslegers von -3° bis $+80^\circ$.
Ausfahren	Das 2. Element wird unabhängig von den anderen von einem hydraulischen Hebebock mit Doppelwirkung ausgefahren. Das 3. und 4. Element können aufgrund eines hydraulischen Hebebocks mit Doppelwirkung und eines innen angebrachten Kettenrückgewinnungssystems proportional und fließend ausgefahren werden. Ausfahren bei Teilbelastung möglich.
Winde	Axialkolben-Hydraulik-Motor mit fester Fördermenge und Planetenumsetzungsgetriebe. Die Absenkbewegung wird automatisch von einer Negativbremse gebremst. Mit Seilklemme ausgestattet. Zwei Drehgeschwindigkeiten. Seildurchmesser 18 mm Länge 200 m. Maximales Hubvermögen 5300 daN. Optionale Zusatzwinde mit Axialkolben-Hydraulikmotorantrieb mit fester Fördermenge und Planetenumsetzungsgetriebe. Die Absenkbewegung wird automatisch von einer Negativbremse gebremst. Mit Seilklemme ausgestattet. Zwei Drehgeschwindigkeiten. Seildurchmesser 15 mm Länge 150 m. Maximales Hubvermögen 3800 daN.
Schwenkung	Dauernde 360° -Schwenkung durch hydraulischen Motor und Planetenumsetzungsgetriebe auf Drehplatte mit doppelter Kugeldrehung und Innenverzahnung. Automatische Negativbremsung. Bremsenspernung zur direkten Anreihung des Auslegers auf der Senkrechten der zu hebenden Last.
Fahrerkabine	Gute Sicht, Schiebetür, Heizung. Vorder- und Deckscheibe mit Scheibenwischer. Deck- und Heckscheibe können geöffnet werden. Vollkommen einstellbarer Fahrersitz mit Stoßdämpfung und aufklappbaren Armlehnen, in denen die Manipulatoren für die Steuerung sämtlicher Bewegungen des Krans angebracht sind.
Schutzvorrichtungen	Sperrventile an den Hebeböcken für die Aus- und Einfahr- bzw. Hebebewegung des Auslegers und auf den Stützauslegern. Drucksperrentile an jeder Hydraulikleitung. Ausgleich- und Bremsventil auf der Schwenkeinheit. Ausgleich- und Bremsventil an der Winde. Endschalter am Auslegerkopf für die Hebebewegung des Blocks. Endschalter, damit stets drei Seilwicklungen auf der Winde vorhanden sind. Lastmomentbegrenzen mit folgenden Angaben: <ul style="list-style-type: none"> Auslegerneigung Auslegerlänge Hublast maximales Hubvermögen Einstellmöglichkeit der Bewegungsbegrenzung des Teleskoparms.

ANLAGEN	
Hydraulische Anlage	Speisung: 1 Doppelzahnradpumpe, 1 Doppelzahnradpumpe und 1 Einzel-Zahnradpumpe. Bewegungssteuerung: durch hydraulische Manipulatoren gesteuerte Verteiler; gleichzeitige Proportionalbewegungen möglich. Stützauslegersteuerung: über unabhängige Druckknöpfe gesteuerte Elektroventile. Filtration: 2 Filter mit Filterkartusche an der Rückleitung. Wärmeaustauscher zur Ölkühlung.
Elektrische Anlage	24 V mit Wechselstromgenerator zu 70 A und 2 Akkumulatoren zu 132 Ah. Beleuchtung nach den Richtlinien der Europäischen Union.
Pneumatische Anlage	Kompressor zu 247 cm^3 , 2 Behälter jeweils zu 45 l und Trockner. Zusätzlicher Lufteinlass und Reifenfüll-Set.

HAUTAUSSTATTUNG	
Zusatzrolle am Auslegerkopf	
Jib-Ausleger („A“-Form), 1,65 m	
Gitterverlängerung, 0,7 + 7,3 m	
Gitterverlängerung, 0,7 + 7,3 + 6 m	
Gitterverlängerung, 0,7 + 7,3 + 6 + 6 m	
Klimaanlage (warm / kalt) in der Fahrerkabine	
Kit für Motorstart bei niedrigen Temperaturen	
Optionale Zusatzwinde	
Unterflasche 12,5 t	
Haken 8 t	
Unterflasche 10 t für optionale Zusatzwinde	
Haken 5 t für optionale Zusatzwinde	

Bei Ihrem gebietszuständigen Händler können Sie eine vollständige Liste der Optionals anfragen.

DIAGRAMMA DI LAVORO / WORKING RANGES / DIAGRAMME DE TRAVAIL / ARBEITSBEREICHE







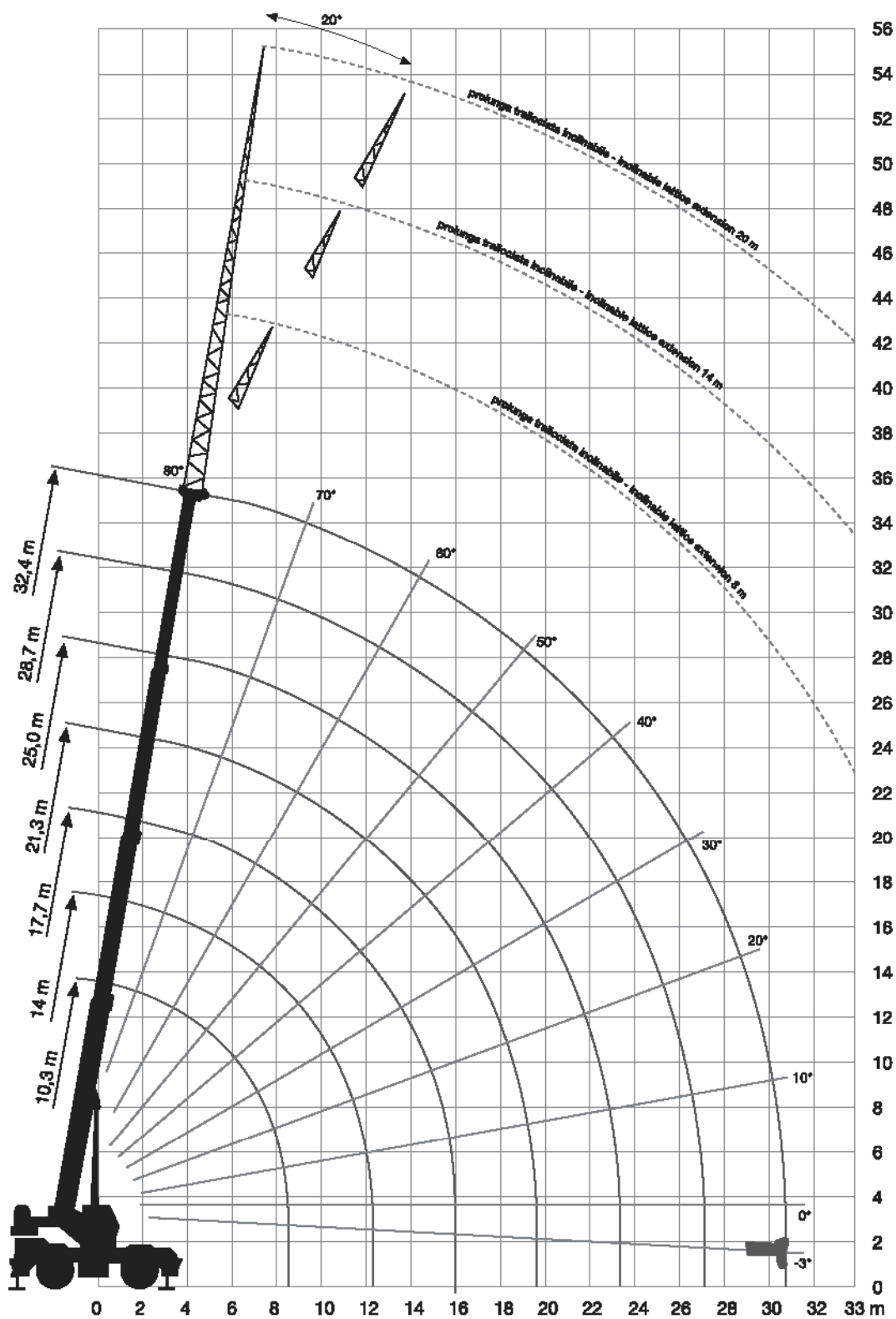
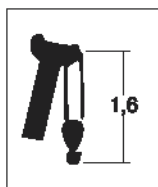
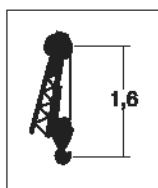
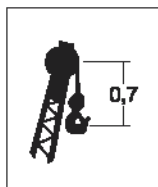

TABELLE / CHART / TABLEAU / TABELLE

				
7.20 m	10.30 m ÷ 32.40 m	8.70 t	360°	















								
	10.30 m	14.00 m	17.70 m	21.30 m	25.00 m	28.70 m	32.40 m	
								
3.0	60.00							3.0
3.5	49.20							3.5
4.0	45.00	41.00	33.80					4.0
4.5	38.60	36.50	31.15					4.5
5.0	36.00	36.00	28.50	24.70	19.90			5.0
6.0	31.50	29.00	25.50	21.80	18.10	15.50		6.0
7.0	25.00	24.00	21.50	19.00	16.40	14.40	11.70	7.0
8.0	19.80	19.50	18.60	16.90	14.70	13.10	11.00	8.0
9.0		17.00	16.80	14.70	13.40	12.30	10.60	9.0
10.0		14.00	13.80	13.50	12.10	11.20	9.60	10.0
11.0		13.00	11.30	11.30	9.80	10.30	8.80	11.0
12.0		10.90	9.70	9.70	9.00	9.50	8.20	12.0
13.0			8.40	8.40	8.40	8.80	7.60	13.0
14.0			6.80	7.20	7.20	7.10	7.10	14.0
15.0			6.60	6.40	6.40	6.40	6.40	15.0
16.0				5.80	5.80	5.80	5.80	16.0
17.0				5.10	5.10	5.50	5.60	17.0
18.0				4.50	4.50	4.40	4.30	18.0
19.0				4.00	4.00	4.10	4.00	19.0
20.0					3.60	3.40	3.70	20.0
21.0					3.15	3.35	3.45	21.0
22.0					2.30	2.80	3.10	22.0
23.0					2.20	2.70	2.90	23.0
24.0						2.60	2.80	24.0
25.0						2.40	2.60	25.0
26.0						2.00	2.30	26.0
27.0							2.10	27.0
28.0							1.80	28.0
29.0							1.60	29.0
30.0							1.50	30.0
31.0								31.0

TABELLE / CHART / TABLEAU / TABELLE

				
7.20 m	32.40 m	8.70 t	360°	8 / 14 / 20





















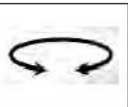

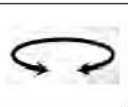





	32.40 m + 8.00 m	32.40 m + 8.00 m	32.40 m + 14.00 m	32.40 m + 14.00 m	32.40 m + 20.00 m	32.40 m + 20.00 m	
	0°	20°	0°	20°	0°	20°	
							
8.0	6.50						8.0
9.0	6.20						9.0
10.0	5.90	3.20	3.30				10.0
11.0	5.60	3.10	3.15				11.0
12.0	5.30	3.00	3.00		2.00		12.0
13.0	5.05	2.95	2.85		1.90		13.0
14.0	4.80	2.90	2.70	1.60	1.80		14.0
15.0	4.55	2.85	2.60	1.55	1.70		15.0
16.0	4.30	2.80	2.50	1.50	1.60	0.90	16.0
17.0	4.10	2.75	2.40	1.45	1.50	0.85	17.0
18.0	3.90	2.70	2.30	1.45	1.45	0.80	18.0
19.0	3.60	2.65	2.20	1.40	1.40	0.80	19.0
20.0	3.30	2.60	2.10	1.40	1.35	0.80	20.0
21.0	3.00	2.45	2.00	1.35	1.30	0.80	21.0
22.0	2.75	2.30	1.90	1.35	1.25	0.80	22.0
23.0	2.40	2.15	1.80	1.30	1.20	0.70	23.0
24.0	2.05	2.05	1.75	1.30	1.15	0.70	24.0
25.0	1.85	1.80	1.65	1.25	1.10	0.70	25.0
26.0	1.65	1.60	1.60	1.25	1.07	0.70	26.0
27.0	1.45	1.45	1.45	1.15	1.00	0.70	27.0
28.0	1.30	1.30	1.30	1.10	1.00	0.70	28.0
29.0	1.15	1.15	1.20	1.05	0.95	0.65	29.0
30.0	1.00	1.00	1.10	1.05	0.90	0.60	30.0
31.0	0.85	0.85	0.85	0.85	0.85	0.60	31.0
32.0	0.70	0.70	0.65	0.70	0.80	0.60	32.0
33.0							33.0
34.0							34.0
35.0							

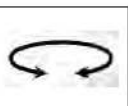

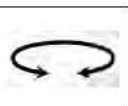





TABELLE / CHART / TABLEAU / TABELLE

							
23.5R25	0 Km/h	360°	0 Km/h	0°	2 Km/h	0°	

														
	10.30 m	14.00 m	17.70 m	10.30 m	14.00 m	17.70 m	21.30 m	25.00 m	10.30 m	14.00 m		17.70 m	21.30 m	25.00 m
3.0				22.10										3.0
3.5	15.35			19.40										3.5
4.0	13.30			17.15										4.0
4.5	11.60	11.30		15.25					13.65					4.5
5.0	10.20	9.60		13.70	12.40				12.25	12.00				5.0
6.0	7.70	6.95	6.20	11.70	10.95				10.15	9.90				6.0
7.0	5.70	5.05	4.60	10.15	9.05	8.90			8.50	8.25	8.05			7.0
8.0	4.35	3.75	3.40	8.45	8.35	8.05			7.20	6.95	6.75			8.0
9.0		2.85	2.50		6.70	6.40	6.95			5.90	5.70	6.05		9.0
10.0		2.10	1.85		5.50	5.15	5.70	5.70		5.00	4.85	5.15	5.45	10.0
11.0		1.55	1.25		4.45	4.15	4.65	4.65		4.25	4.10	4.40	4.65	11.0
12.0		1.05			3.55	3.35	3.80	3.80		3.55	3.35	3.80	3.80	12.0
13.0						2.65	3.10	3.15			2.65	3.10	3.15	13.0
14.0						2.10	2.45	2.45			2.10	2.45	2.45	14.0
15.0						1.55	1.95	2.00			1.55	1.95	2.00	15.0
16.0							1.60	1.60				1.60	1.60	16.0
17.0							1.25	1.30				1.25	1.30	17.0
18.0							1.00	1.05				1.00	1.05	18.0

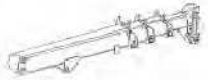
							
26.5R25	0 Km/h	360°	0 Km/h	0°	2 Km/h	0°	

														
	10.30 m	14.00 m	17.70 m	10.30 m	14.00 m	17.70 m	21.30 m	25.00 m	10.30 m	14.00 m		17.70 m	21.30 m	25.00 m
3.0				22.10										3.0
3.5	15.35			19.40										3.5
4.0	13.30			17.15										4.0
4.5	11.60	11.30		15.25					13.65					4.5
5.0	10.20	9.60		13.70	12.40				12.25	12.00				5.0
6.0	7.70	6.95	6.20	11.70	10.95				10.15	9.90				6.0
7.0	5.70	5.05	4.60	10.15	9.05	8.90			8.50	8.25	8.05			7.0
8.0	4.35	3.75	3.40	8.45	8.35	8.05			7.20	6.95	6.75			8.0
9.0		2.85	2.50		6.70	6.40	6.95			5.90	5.70	6.05		9.0
10.0		2.10	1.85		5.50	5.15	5.70	5.70		5.00	4.85	5.15	5.45	10.0
11.0		1.55	1.25		4.45	4.15	4.65	4.65		4.25	4.10	4.40	4.65	11.0
12.0		1.05			3.55	3.35	3.80	3.80		3.55	3.35	3.80	3.80	12.0
13.0						2.65	3.10	3.15			2.65	3.10	3.15	13.0
14.0						2.10	2.45	2.45			2.10	2.45	2.45	14.0
15.0						1.55	1.95	2.00			1.55	1.95	2.00	15.0
16.0							1.60	1.60				1.60	1.60	16.0
17.0							1.25	1.30				1.25	1.30	17.0
18.0							1.00	1.05				1.00	1.05	18.0

				
Outriggers fully extended Stabilisateurs en extension totale Stabilizzatori completamente estesi Voll ausgefahrene Abstützungen	Outriggers half-extended Stabilisateurs en extension partielle Stabilizzatori parzialmente estesi Teilweise ausgefahrene	Outriggers unextended Stabilisateurs fermés Stabilizzatori chiusi Eingefahrene Abstützungen	Load capacity on wheels Charges sur pneus Portale su pneumatici Tragfähigkeit auf Reifen	Traveling speed Vitesse de translation Velocità traslazione Bewegungsgeschwindigkeit
				
Telescopic boom Flèche télescopique Braccio telescopico Teleskoparm	Counterweight Contrepoids Contrappeso Gegengewicht	Upperstructure angle rotation Angle rotation structure du dessus Angolo rotazione sovrastruttura Drehwinkel des Strukturaufbaus	Upperstructure rotation lock Blocage rotation structure du dessus Rotazione sovrastruttura bloccata Bolzen des Strukturaufbaus	Extension / Jib Extension / Jib Prolunga / Jib Verlängerung / Jib

TAGLIE DI SOLLEVAMENTO / HOIST REEVING / MOUFLAGE / HUBROLLEN

N° di taglie / No. of line Nbr. de brins / Seilanzahl	1	2	3	4	5	6	7	8	9	10	11	12
--	---	---	---	---	---	---	---	---	---	----	----	----

ARGANO PRINCIPALE / MAIN WINCH / TREUIL PRINCIPAL / HAUPTWINDE

Carico massimo in kN / Max line pull in kN Charges maxi en kN / Höchstlast in kN	63	103	159	212	265	318	371	424	477	530	583	636
---	----	-----	-----	-----	-----	-----	-----	-----	-----	-----	-----	-----

ARGANO AUSILIARIO / AUXILIARY WINCH / TREUIL AUXILIAIRE / ZUSATZWINDE

Carico massimo in kN / Max line pull in kN Charges maxi en kN / Höchstlast in kN	38	76	114	152	190	228	266	304	342	380	418	456
---	----	----	-----	-----	-----	-----	-----	-----	-----	-----	-----	-----

NOTE	NOTES	NOTES	HINWEISE
<p>I carichi indicati costituiscono i valori massimi coperti dalla garanzia del costruttore per utilizzo rispettivamente secondo le norme della Unione Europea (CE). Sono espressi in tonnellate metriche ed includono il peso del bozzello, delle eventuali prolunghe applicate al braccio e di tutti gli accessori di sollevamento (brache, ecc.) Le operazioni di sollevamento nella configurazione su gomme devono essere effettuate su superficie piana e solida con la corretta pressione di gonfiaggio degli pneumatici e con l'oscillazione dell'assale posteriore bloccata qualora l'operazione non avvenga con braccio entro un settore di +/- 3° rispetto all'asse di mezzeria della autogrù. Le operazioni di traslazione con carico possono avvenire esclusivamente con braccio allineato all'asse di mezzeria della autogrù, perno di bloccaggio meccanico della rotazione della sovrastruttura inserito e avendo cura di mantenere il carico stesso in prossimità della autogrù senza oscillazioni</p>	<p>The indicated loads are the maximum covered by the manufacturer's warranty for a use which complies with current EU directives (CE). Weights are given in metric tons. They include the weight of the block, all extensions fitted to the boom and all lifting accessories (slings and so on). Crane on wheels: operate the crane on a steady flat surface when hoisting loads and inflate tyres at proper pressure value. Also stop rear axle swinging if the load cannot be lifted having the arm within a +/- 3° sector to the crane centreline. The load can be travelled only if the boom is aligned with the crane centreline, the shaft for upper structure rotation stop is fitted and the load is kept close to the crane and is not swinging.</p>	<p>Les charges indiquées constituent les valeurs maximales couvertes par la garantie du fabricant pour une utilisation conforme aux normes de l'Union Européenne. Elles sont exprimées en tonnes métriques et comprennent le poids de la moufle, des éventuelles extensions appliquées à la flèche et de tous les accessoires de levage (élingues, etc.). Les opérations de levage dans la configuration sur pneus doivent être effectuées sur une surface plane et solide avec une pression de gonflage des pneus correcte et l'oscillation de l'essieu arrière bloquée si l'opération n'a pas lieu avec la flèche située dans une zone de +/- 3° par rapport à l'axe de moitié du camion-grue. Les opérations de translation avec charge ne peuvent être effectuées qu'avec flèche alignée dans l'axe de moitié du camion-grue, goujon de blocage mécanique de la rotation de la structure du dessus enclenché et en prenant soin de maintenir la charge à proximité du camion-grue sans oscillations.</p>	<p>Die angegebenen Lasten sind die Grenzwerte, für welche die Herstellergarantie bei Einsatz gemäß den Normen der Europäischen Union (EU). Die Grenzwerte sind in Meter-tonnen ausgedrückt, das Gewicht des Blocks, eventueller am Ausleger angebrachter Verlängerungen und jeglicher Hebezubehörteile (Schlingen usw.) ist inbegriffen. Hebearbeiten mit bereiftem Kran müssen auf einer ebenen und festen Oberfläche erfolgen; die Reifen müssen richtig befüllt und die Hinterachse festgestellt sein, wenn der Ausleger außerhalb eines Bereichs von +/- 3° im Verhältnis zur Mittelachse des fahrbaren Krans gehoben wird. Transportarbeiten mit belastetem Ausleger sind ausschließlich erlaubt, wenn der Ausleger an der Mittelachse des Krans angereicht ist, der mechanische Verriegelungszapfen, der die Drehung des Oberwagens verhindert, eingerastet ist und die Last ohne zu schwingen in Nähe des Krans behalten wird.</p>

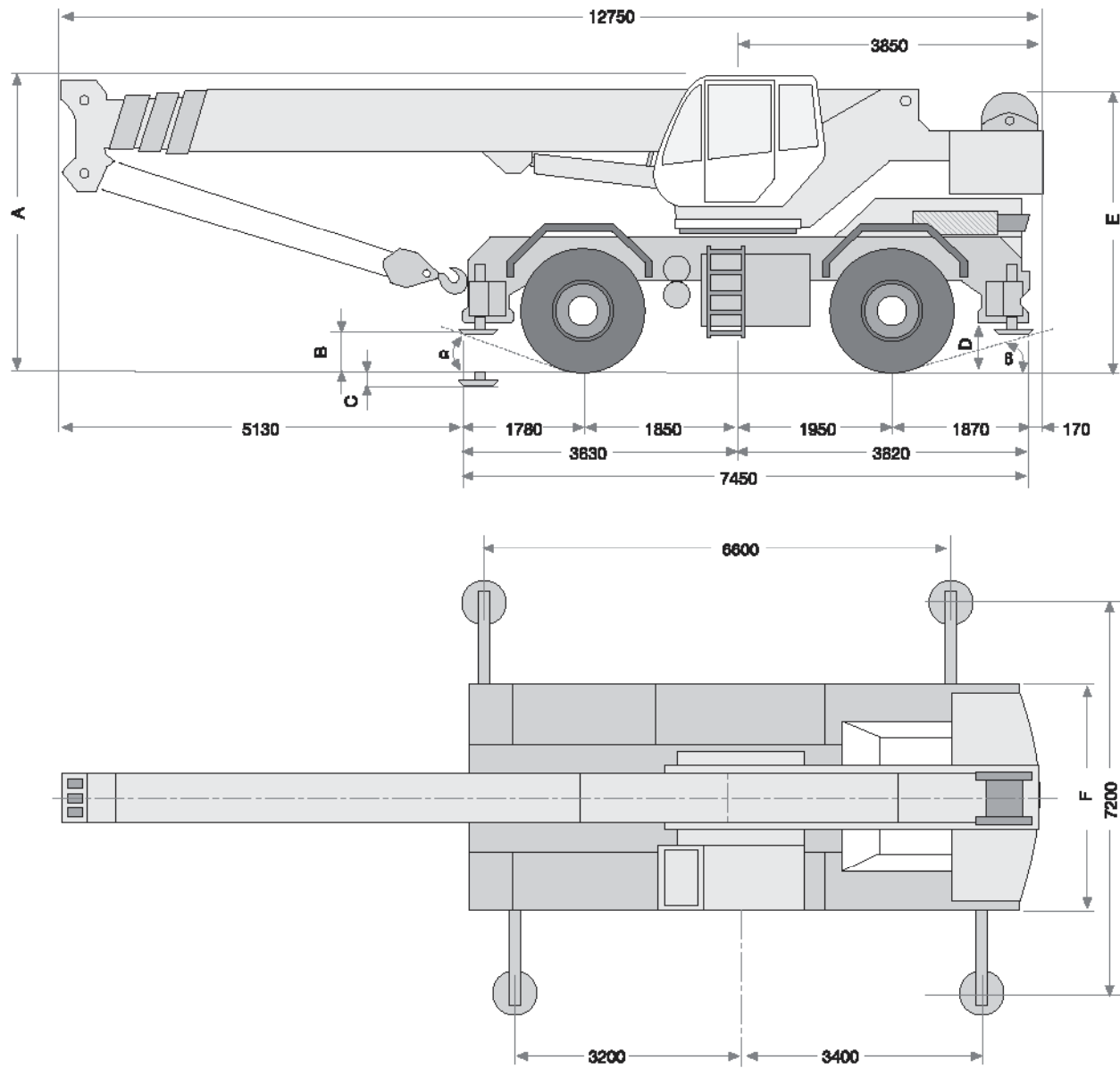

DIMENSIONI / DIMENSIONS / DIMENSIONS / ABMESSUNGEN ⁽⁴⁾

Pneumatici / Tyres Pneumatiques / Reifen	A	E	C	B	D	α	β	F
23.5R25	3570	3580	200	290	520	20°	18°	3000
26.5R25	3650	3660	130	325	550	22°	20°	3000

(4) Dimensioni medie di riferimento fornite a puro titolo indicativo. Valori espressi in millimetri
(4) Average reference values, which are indicative only. Values are expressed in mm

(4) Dimensions moyennes de référence fournies à titre purement indicatif. Valeurs exprimées en millimètres
(4) Durchschnittsmaße, dienen ausschließlich als Richtwerte. Die Werte sind in Millimetern ausgedrückt

NOTE

Ci riserviamo il diritto di modificare le specifiche e i prezzi dei prodotti in ogni momento e senza preavviso. Le fotografie e/o i disegni contenuti in questo documento sono destinati unicamente a scopi illustrativi. Consultare le istruzioni sull'uso corretto di questo macchinario contenute nell'opportuno Manuale d'uso. L'inottemperanza delle istruzioni contenute nel Manuale d'uso del macchinario e altri comportamenti irresponsabili possono provocare gravi lesioni, anche mortali. L'unica garanzia applicabile ai nostri macchinari è la garanzia scritta standard applicabile al particolare prodotto e alla particolare vendita; Terex è esonerata dal fornire qualsiasi altra garanzia, esplicita o implicita. I prodotti e servizi elencati possono essere dei marchi di fabbrica, marchi di servizio o nomi commerciali di TEREX Corporation e/o società affiliate negli Stati Uniti d'America e altre nazioni e tutti i diritti sono riservati. "TEREX" è un marchio registrato di Terex Corporation negli USA e molti altri Paesi. Copyright © 2007 Terex Corporation.

NOTES

Product specifications and prices are subject to change without notice or obligation. The photographs and/or drawings in this document are for illustrative purposes only. Refer to the appropriate Operations Manual for instructions on the proper use of this equipment. Failure to follow the appropriate Operations Manual when using our equipment or to otherwise act irresponsibly may result in serious injury or death. The only warranty applicable to our equipment is the standard written warranty applicable to the particular product and sale and Terex makes no other warranty, express or implied. Products and services listed may be trademarks, service marks or trade-names of Terex Corporation and/or its subsidiaries in the USA and other countries. All rights are reserved. Terex® is a registered trademark of Terex Corporation in the USA and many other countries. Copyright 2007 Terex Corporation.

NOTES

Les spécifications et prix des produits sont sujets à modification sans avis ou obligation. Les photographies et/ou dessins contenus dans ce document sont uniquement pour illustration. Veuillez vous référer à la notice d'utilisation appropriée pour les instructions quant à l'utilisation correcte de cet équipement. Tout manquement au suivi de la notice d'utilisation appropriée lors de l'utilisation de notre équipement ou tout acte autrement irresponsable peut résulter en blessure corporelle sérieuse ou mortelle. La seule garantie applicable à notre équipement est la garantie standard écrite applicable à un produit et à une vente spécifique. Terex n'offre aucune autre garantie, expresse ou implicite. Les produits et services proposés peuvent être des marques de fabrique, des marques de service ou des appellations commerciales de Terex Corporation et/ou ses filiales aux États Unis et dans les autres pays, et tous les droits sont réservés. "TEREX" est une marque déposée de Terex Corporation aux États Unis et dans de nombreux autres pays. Copyright 2007 Terex Corporation.

HINWEISE

Produktbeschreibungen und Preise können jederzeit und ohne Verpflichtung zur Ankindigung geändert werden. Die in diesem Dokument enthaltenen Fotos und/oder Zeichnungen dienen rein anschaulichen Zwecken. Anweisungen zur ordnungsgemäßen Verwendung dieser Ausrüstung entnehmen Sie bitte dem zugehörigen Betriebshandbuch. Nichtbefolgung des Betriebshandbuchs bei der Verwendung unserer Produkte oder anderweitig fahrlässiges Verhalten kann zu schwerwiegenden Verletzungen oder Tod führen. Für dieses Produkt wird ausschließlich die entsprechende, schriftlich niedergelegte Standardgarantie gewährt. Terex leistet keinerlei darüber hinaus gehende Garantie, weder ausdrücklich noch stillschweigend. Die Bezeichnungen der aufgeführten Produkte und Leistungen sind gegebenenfalls Marken, Service-marken oder Handelsnamen der Terex Corporation und/oder ihrer Tochtergesellschaften in den USA und anderen Ländern. Alle Rechte vorbehalten. "TEREX" ist eine eingetragene Marke der Terex Corporation in den USA und vielen anderen Ländern. Copyright 2007 Terex Corporation.



ISO 9001 - Cert. 1151/2

cod. 38725 - rev. 08 del 09/08



TEREX ITALIA S.r.l. - Via Cassoletta 76
40056 Crespellano BO - ITALY
Tel.: (+39) 051 6501011
Fax: (+39) 051 734645
internet: www.terex.it
e-mail: terexitalia@terex.it

