

60 t
TEC60



SPECIFICHE TECNICHE
PRESTAZIONI DELLA GRU

Portata a 3 m da asse ralla. Lunghezza braccio (chiuso / aperto). Altezza testa braccio.	60 t 10.3 / 32.4 m 34.5 m
--	---------------------------------

La macchina può sollevare carichi in condizioni statiche o in movimento fino a una inclinazione di 4° in direzione longitudinale e/o trasversale secondo apposite tabelle di carico.

PRESTAZIONI DEL CARRO

Velocità massima di traslazione.	2.5 km/h
----------------------------------	----------

MASSE ⁽¹⁾

Cingolo destro	Cingolo sinistro	Totale
29.5 t	29.5 t	59 t

(1) Gru in versione standard: senza argano ausiliario, senza prolunghe.

VELOCITÀ / TEMPI DI LAVORO ⁽²⁾

Argano principale (massima in tiro diretto). Argano ausiliario (massima in tiro diretto). Sollevamento / Discesa braccio telescopico. Sfilo / Rientro braccio telescopico (da 10.3 m a 32.4 m). Rotazione sovrastruttura.	135 m/min 80 m/min 50 / 40 s 60 / 50 s 30 s
---	---

(2) Valori medi di riferimento misurati a 2000 giri/min motore e forniti a puro titolo indicativo

SOTTOCARRO

Telaio	Struttura saldata a cassone. Punti di traino anteriore e posteriore. Cingoli allargabili a pantografo.
Motore	CUMMINS QSB6.7: 6 cilindri in linea - Cilindrata 6.7 dm ³ - Raffreddato ad acqua con intercooler – Turbocompresso – Common rail. Potenza massima 164 kW a 2200 giri/min - Coppia massima 945 Nm a 1500 giri/min. Certificazione 2004/26/CE Fase IIIA.
Serbatoio	300 l.
Trasmissione	Idrostatica in circuito chiuso su ciascun cingolo mediante un riduttore ruota indipendente azionato da motore idraulico a doppia cilindrata.
Cingoli	In acciaio con pattini sagomati. Larghezza 900 mm.

SOVRASTRUTTURA

Braccio	n. 4 elementi a sezione ottagonale.
Sollevamento	n. 1 martinetto idraulico a doppio effetto. Possibilità di inclinazione del braccio da -3° a $+80^{\circ}$.
Sfilo	L'elemento 2 è sfilato in modo indipendente rispetto ai rimanenti mediante un martinetto idraulico a doppio effetto. Gli elementi 3 e 4 sono sfilati in modo proporzionale e continuo mediante un martinetto idraulico a doppio effetto ed un sistema interno di rinvio a catene. Possibilità di sfilo sotto carico parziale.
Argano	Azionato da motore idraulico a pistoncini assiali a doppia cilindrata con riduttore epicicloidale. Freno negativo sulla discesa ad inserimento automatico. Dispositivo pressafune. Doppia velocità di rotazione. Fune diametro 18 mm lunghezza 200 m. Capacità massima di sollevamento 5300 daN. In opzione argano ausiliario azionato da motore idraulico a pistoncini assiali a cilindrata fissa con riduttore epicicloidale. Freno negativo sulla discesa ad inserimento automatico. Dispositivo pressafune. Doppia velocità di rotazione. Fune diametro 15 mm lunghezza 150 m. Capacità massima di sollevamento 3800 daN.
Rotazione	Continua su 360° mediante motore idraulico e riduttore epicicloidale su ralla a doppio giro di sfere con dentatura interna. Freno negativo ad inserimento automatico. Comando di sblocco del freno per l'allineamento diretto del braccio sulla verticale del carico da sollevare.
Cabina	Ad ampia visibilità con sportello scorrevole. Dotata di riscaldamento. Vetro anteriore e superiore con tergicristallo. Vetro superiore e posteriore apribili. Sedgiolino completamente regolabile su sospensioni anti-shock, dotato di braccioli sollevabili che integrano i manipolatori per il comando dei vari movimenti della gru.
Sicurezza	Valvole di massima pressione su ogni circuito idraulico. Valvola di bilanciamento e frenatura su gruppo rotazione. Valvola di bilanciamento e frenatura sull'argano. Interruttore di fine corsa su testa braccio per la salita del bozzello. Interruttore di fine corsa per conservare tre giri di avvolgimento fune sull'argano. Dispositivo limitatore di carico con indicazione: Inclinazione braccio Lunghezza braccio Carico sollevato Massimo carico sollevabile Possibilità di impostare la limitazione dei movimenti del braccio telescopico.

IMPIANTI

Idraulico	Alimentazione: n. 1 pompa tripla ad ingranaggi e n. 2 pompe a pistoncini a cilindrata variabile. Controllo movimenti: distributori azionati da manipolatori idraulici con possibilità di manovre simultanee proporzionali. Controllo cingoli: distributori azionati da pedipolatori dotati di leve. Filtraggio: n. 2 filtri a cartuccia sul circuito di ritorno e n. 2 filtri sul circuito di aspirazione delle pompe a pistoncini.
Elettrico	a 24 V con alternatore da 70 A e n. 2 batterie da 132 Ah.

OPZIONALI PRINCIPALI

Rooster sheave
Prolunga da 8 m. Angolazioni: 0° , 20°
Impianto condizionatore caldo/freddo in cabina guida
Kit per operare fino a -20°C
Kit per operare fino a $+45^{\circ}\text{C}$
Argano ausiliario
Bozzello da 12,5 T
Gancio da 8 T
Bozzello da 10 T per argano ausiliario
Gancio da 5 T per argano ausiliario

Riferirsi al dealer di zona per un elenco completo degli opzionali.

SPECIFICATIONS

CRANE PERFORMANCE DATA

Capacity at 3 m from slewing axis. Boom length (retracted / extended). Boom head height.	60 t 10.3 / 32.4 m 34.5 m
--	---------------------------------

The machine can lift static or moving loads up to 4° slant -lengthwise and/or crosswise- as specified in the relevant lifting capacity charts.

TRUCK PERFORMANCE DATA

Max. travelling speed.	2.5 km/h
------------------------	----------

WEIGHTS ⁽¹⁾

Right track	Left track	Total
29.5 t	29.5 t	59 t

(1) Standard crane: no auxiliary winch and no extensions.

OPERATING SPEED / TIMES ⁽²⁾

Main winch (max. speed under direct pull)	135 m/min
Auxiliary winch (max. speed under direct pull)	80 m/min
Telescopic boom lifting / lowering	50 / 40 s
Telescopic boom extension / retraction (10.3 m to 32.4 m)	60 / 50 s
Upper structure slewing	30 s

(2) Average reference indicative values measured at 2000 rpm of engine

UNDERTRUCK

Frame	Welded body. Front and back hitch point. Pantograph widening tracks .
Engine	CUMMINS QSB6.7: no. 6 in-line cylinders - displacement: 6.7 cu dm - water cooling with intercooler - turbo supercharger - Common rail. Max. power 164 kW at 2200 rpm - Max. torque 945 Nm at 1500 rpm. 2004/26/CE Step IIIA approved.
Tank	300 l.
Transmission	Hydrostatic loop transmission on each track through a separate gearbox controlled by double displacement hydraulic motor.
Tracks	Steel tracks featuring profiled runners. 900 mm wide.

UPPER STRUCTURE

Boom	no. 4 octagonal elements.
Lifting	no. 1 double action hydraulic jack. Boom inclination: -3° to +80°
Extension	Separate extension of element 2 through double action hydraulic jack. Continuous proportional extension of elements 3 and 4 through double action hydraulic jack and inner chain-driven system. Extension under partial load possible.
Winch	Controlled by double displacement hydraulic motor equipped with axial pistons and planetary gearbox. Automatic negative brake for winch lowering. Cable tensioner. Two different rotation speeds. Rope diameter 18 mm length: 200 m. Max. lifting capacity 5300daN. On request, auxiliary winch controlled by fixed displacement hydraulic motor equipped with axial pistons and planetary gearbox. Automatic negative brake for winch lowering. Rope clamp. Two different rotation speeds. Rope diameter 15 mm length 150 m. Max. lifting capacity 3800daN.
Rotation	360° non-stop rotation controlled by hydraulic motor equipped with planetary gearbox on slewing ring having double ball ring and inner toothing. Automatic negative brake. Brake release for direct alignment of boom along load vertical line.
Operating cab	Sliding door. Wide visibility. Equipped with heating system. Front and upper window with windscreen wiper. Upper and back windows can be opened. Fully adjustable seat onto shockproof suspensions. Equipped with tiltable arm rests with integrated hand controls for crane operation.
Safety	Max. pressure valves for each hydraulic circuit. Balancing braking valve for the slewing unit. Balancing braking valve for the winch. Limit switch onto boom head for hoisting block lift. Limit switch for having three winding turns around the winch. Load limiting device with indicator for: <ul style="list-style-type: none"> Boom inclination Boom length Load weight Max. load which can be lifted <p>Telescopic boom movement limit can be set.</p>

SYSTEMS

Hydraulic system	Feeding: no. 1 triple gear pump and no. 2 variable displacement piston pumps. Movement control: distributors controlled by hydraulic manipulators. More proportional operations can be carried out at the same time. Track control: distributors controlled by foot controls. Filtering: no. 2 cartridge filters in return circuit and no. 2 filters in intake circuit of piston pumps.
Electric system	24 V, 70 A generator and no. 2 132 Ah batteries.

MAIN OPTIONS

Rooster sheave
Extension 8 m, offsettable at 0°, 20°
Air conditioning / heating system into operating cab
Operating kit for temperatures up to -20°C
Operating kit for temperatures up to +45°C
Auxiliary winch
12,5 t hook block
8 t hook
10 t hook block for auxiliary winch
5 t hook for auxiliary winch

Refer to your local dealer for a complete list of available options.

CARACTÉRISTIQUES

PERFORMANCES DE LA GRUE

Capacité à 3 m depuis l'axe d'orientation (CE)	60 t
Longueur de la flèche (fermée / ouverte)	10.3 / 32.4 m
Hauteur tête flèche	34.5 m

La machine peut soulever des charges soit en conditions statiques qu'en mouvement jusqu'à une inclinaison de 4° en direction longitudinale ou transversale, selon les tableaux des charges spéciales.

PERFORMANCES DU CHÂSSIS

Vitesse maximum de translation	2.5 km/h
--------------------------------	----------

MASSES ⁽¹⁾

Chenille droite	Chenille gauche	Total
29.5 t	29.5 t	59 t

(1) Grue en version standard : sans treuil auxiliaire, sans extension

VITESSE / TEMPS DE FONCTIONNEMENT ⁽²⁾

Treuil principal (maximum en tirage direct)	135 m/min
Treuil auxiliaire (maximum en tirage direct)	80 m/min
Relevage / Descente flèche télescopique	50 / 40 s
Télescopage flèche (de 10.3 m à 32.4 m)	60 / 50 s
Orientation partie tournante	30 s

(2) Valeurs moyennes de référence mesurées à 2000 tr/min moteur et fournies à titre purement indicatif

CHÂSSIS

Structure	Structure soudée à caisson. Points de traction avant et arrière. Chenilles avec possibilité d'élargissement à pantographe
Moteur	CUMMINS QSB6.7: 6 cylindres en ligne - Cylindrée 6.7 dm ³ - Refroidi à eau avec intercooler – Turbocompressé - Common rail. Puissance maximum 164 kW à 2200 tours/min - Couple maximum 945 Nm à 1500 min. Certification 2004/26/CE Phase IIIA
Réservoir	300 l
Transmission	Hydrostatique en circuit fermé sur chaque chenille au moyen d'un réducteur de roue indépendant actionné par un moteur hydraulique à double cylindrée
Chenilles	En acier avec patins façonnés. Largeur 900 mm

PARTIE TOURNANTE

Flèche	n. 4 éléments à section octogonale
Relevage	n. 1 vérin hydraulique à double effet. Possibilité d'incliner la flèche de -3° à $+80^{\circ}$
Télescopage	L'élément 2 est télescopé indépendamment des autres au moyen d'un vérin hydraulique à double effet. Les éléments 3 et 4 sont télescopés de façon proportionnelle et continue au moyen d'un vérin hydraulique à double effet et d'un système interne de renvoi à chaînes. Possibilité de télescopage sous charge partielle
Treuil	Actionné par un moteur hydraulique à pistons axiaux à double cylindrée avec réducteur épicycloïdal. Frein négatif sur la descente à enclenchement automatique. Dispositif serre-câble. Double vitesse de rotation. Câble diamètre 18 mm longueur 200 m. Capacité maximum de levage 5300 daN. En option treuil auxiliaire actionné par un moteur hydraulique à pistons axiaux à cylindrée fixe avec réducteur épicycloïdal. Frein négatif à enclenchement automatique sur la descente. Dispositif serre-câble. Double vitesse de rotation. Câble diamètre 15 mm longueur 150 m. Capacité maximum de levage 3800 daN
Orientation	Continue sur 360° au moyen d'un moteur hydraulique et d'un réducteur épicycloïdal sur couronne d'orientation à double tour de billes avec denture interne. Frein négatif à enclenchement automatique. Commande de déblocage du frein pour l'alignement direct de la flèche à la verticale de la charge à lever
Cabine	A large visibilité avec porte coulissante. Dotée de chauffage. Vitres avant et supérieure avec essuie-glaces. Vitres supérieure et arrière ouvrables. Siège entièrement réglable sur suspension antichoc, doté d'accoudoirs relevables comprenant les manipulateurs pour la commande des différents mouvements de la grue.
Sécurité	Soupapes de pression maximum sur chaque circuit hydraulique. Vanne d'équilibrage et de freinage sur le groupe d'orientation. Vanne d'équilibrage et de freinage sur le treuil. Interrupteur de fin de course sur tête flèche pour la montée de la moufle. Interrupteur de fin de course pour conserver trois tours d'enroulement câble sur le treuil. Limiteur de charge avec indication: <ul style="list-style-type: none">Inclinaison flècheLongueur flècheCharge levéeCharge maximale levable Possibilité de programmer la limitation des mouvements du bras télescopique.

CIRCUITS

Hydraulique	Alimentation: n. 1 pompe tripe à engrenage et n. 2 pompes à pistons à cylindrée variable. Contrôle des mouvements: distributeurs actionnés par des manipulateurs hydrauliques avec possibilité de manœuvres simultanées proportionnelles. Contrôle chenilles: distributeurs actionnés par des manipulateurs à pédalier. Filtrage: n. 2 filtres à cartouche sur le circuit de retour et n. 2 filtres sur le circuit d'aspiration des pompes à pistons.
Electrique	à 24 V avec alternateur de 70 A et n. 2 batteries de 132 Ah

OPTIONS PRINCIPALES

Rooster sheave
Extension de 8 m. Angles : 0° , 20°
Groupe de climatisation chaud / froid dans la cabine de conduite
Kit pour intervenir jusqu'à -20°C
Kit pour intervenir jusqu'à $+45^{\circ}\text{C}$
Treuil auxiliaire
12,5 t moufle
Crochet 8 t
10 t moufle pour treuil auxiliaire
Crochet 5 t pour treuil auxiliaire

Se référer au concessionnaire local pour une liste complète des options.

TECHNISCHE DATEN

EIGENSCHAFTEN DES KRANS

Tragfähigkeit bei 3.0 m ab Drehplatte. Auslegerlänger (eingefahren/ausgefahren). Auslegerkopfhöhe.	60 t 10.3 / 32.4 m 34.5 m
--	---------------------------------

Die Maschine kann den entsprechenden Lasttabellen gemäß sich in statischen Bedingungen oder sich in Bewegung befindliche Lasten bis auf eine Neigung von 4° längs und/oder quer heben.

EIGENSCHAFTEN DES WAGENS

Höchstgeschwindigkeit.	2.5 km/h
------------------------	----------

GEWICHT ⁽¹⁾

Raupen rechts	Raupen links	Gesamt
29.5 t	29.5 t	59 t

(1) Kran in Standardausführung und bei Betrieb: ohne Zusatzwinde und ohne Auslegerverlängerungen.

BETRIEBSGESCHWINDIGKEIT / -ZEITEN ⁽²⁾

Hauptwinde (Höchstgeschwindigkeit bei direktem Zug erste schicht). Zusatzwinde (Höchstgeschwindigkeit bei direktem Zug erste schicht). Heben / Senken des Teleskopauslegers. Ausfahren / Einfahren des Teleskopauslegers (von 10.3 m bis 32.4 m). Schwenken des Oberwagens.	135 m/min 80 m/min 50 / 40 s 60 / 50 s 30 s
---	---

(2) Durchschnittliche Bezugswerte, die bei einer Motordrehzahl von 2000/min gemessen wurden und die als reine Anhaltswerte angegeben werden

UNTERWAGEN

Rahmen	Verschweißter Kastenrahmen. Die Raupen werden hydraulisch angetrieben.
Motor	CUMMINS QSB6.7: Reihenmotor mit 6 Zylindern - Hubraum 6.70 dm ³ - mit Intercooler-Wasserkühlung - Turbokompressor. Höchstleistung 164 kW bei 2200 U/min - maximales Drehmoment 945 Nm bei 1500 U/min. Zertifizierung: 2004/26/EG Stufe IIIA.
Behälter	300 l.
Lenkung	Hydrostatische Lenkung im geschlossenen Kreislauf auf jeder Raupe über ein unabhängiges Radumsetzungsgetriebe mit Hydraulikmotorantrieb und Doppelhubraum.
Raupen	Aus Stahl mit geformten Blöcken. Breite: 900 mm.

OBERWAGEN

Ausleger	4 Elemente mit achteckigem Querschnitt
Heben	1 hydraulischer Hebebock mit Doppelwirkung. Neigung des Auslegers von -3° bis $+80^{\circ}$
Ausfahren	Das 2. Element wird unabhängig von den anderen von einem hydraulischen Hebebock mit Doppelwirkung ausgefahren. Das 3. und 4. Element können aufgrund eines hydraulischen Hebebocks mit Doppelwirkung und eines innen angebrachten Kettenrückgewinnungssystems proportional und fließend ausgefahren werden. Ausfahren bei Teilbelastung möglich
Winde	Axialkolben-Hydraulik-Motor mit fester Fördermenge und Planetenumsetzungsgetriebe. Die Absenkbewegung wird automatisch von einer Negativbremse gebremst. Mit Seilklemme ausgestattet. Zwei Drehgeschwindigkeiten. Seildurchmesser 18 mm Länge 200 m. Maximales Hubvermögen 5300 daN. Optionale Zusatzwinde mit Axialkolben-Hydraulikmotorantrieb mit fester Fördermenge und Planetenumsetzungsgetriebe. Die Absenkbewegung wird automatisch von einer Negativbremse gebremst. Mit Seilklemme ausgestattet. Zwei Drehgeschwindigkeiten. Seildurchmesser 15 mm Länge 150 m. Maximales Hubvermögen 3800 daN
Schwenkung	Dauernde 360° -Schwenkung durch hydraulischen Motor und Planetenumsetzungsgetriebe auf Drehplatte mit doppelter Kugeldrehung und Innenverzahnung. Automatische Negativbremsung. Bremsentsperrung zur direkten Anreihung des Auslegers auf der Senkrechten der zu hebenden Last
Fahrerkabine	Gute Sicht, Schiebetür, Heizung. Vorder- und Deckscheibe mit Scheibenwischer. Deck- und Heckscheibe können geöffnet werden. Vollkommen einstellbarer Fahrersitz mit Stoßdämpfung und aufklappbaren Armlehnen, in denen die Manipulatoren für die Steuerung sämtlicher Bewegungen des Krans angebracht sind.
Schutzvorrichtungen	Sperrventile an den Hebeböcken für die Aus- und Einfahr- bzw. Hebebewegung des Auslegers und auf den Stützauslegern. Drucksperrventile an jeder Hydraulikleitung. Ausgleich- und Bremsventil auf der Schwenkeinheit. Ausgleich- und Bremsventil an der Winde. Endschalter am Auslegerkopf für die Hebebewegung des Blocks. Endschalter, damit stets drei Seilwicklungen auf der Winde vorhanden sind. Lastmomentbegrenzer mit folgenden Angaben: <ul style="list-style-type: none">AuslegerneigungAuslegerlängeHublastmaximales Hubvermögen Einstellmöglichkeit der Bewegungsbegrenzung des Teleskoparms.

ANLAGEN

Hydraulische Anlage	Speisung: 1 Dreifachzahnradpumpe und 2 Kolbenpumpen mit veränderbarem Hubraum. Bewegungssteuerung: durch hydraulische Manipulatoren gesteuerte Verteiler; gleichzeitige Proportionalbewegungen möglich. Raupesteuerung: Durch Fußsteuerungen mit Hebeln gesteuerte Verteiler. Filtration: 2 Filter mit Filterkartusche an der Rückleitung und 2 Filter an der Ansaugleitung der Kolbenpumpen.
Elektrische Anlage	24 V mit Wechselstromgenerator zu 70 A und 2 Akkumulatoren zu 132 Ah.

HAUTAUSSTATTUNG

Rooster sheave
1-teilige Spitze, 8 m. Einstellbereich: 0° , 20°
Klimaanlage (warm / kalt) in der Fahrerkabine
Set für den Betrieb bis zu -20°C
Set für den Betrieb bis zu $+45^{\circ}\text{C}$
Optionale Zusatzwinde
Unterflasche 12,5 t
Haken 8 t
Unterflasche 10 t für optionale Zusatzwinde
Haken 5 t für optionale Zusatzwinde

Bei Ihrem gebietszuständigen Händler können Sie eine vollständige Liste der Optionals anfragen.

DIAGRAMMA DI LAVORO / WORKING RANGES / DIAGRAMME DE TRAVAIL / ARBEITSBEREICHE







TABELLE / CHART / TABLEAU / TABELLE

					
5.95 m	360°	max 1°	0 Km/h	10.3 m ÷ 32.4m	

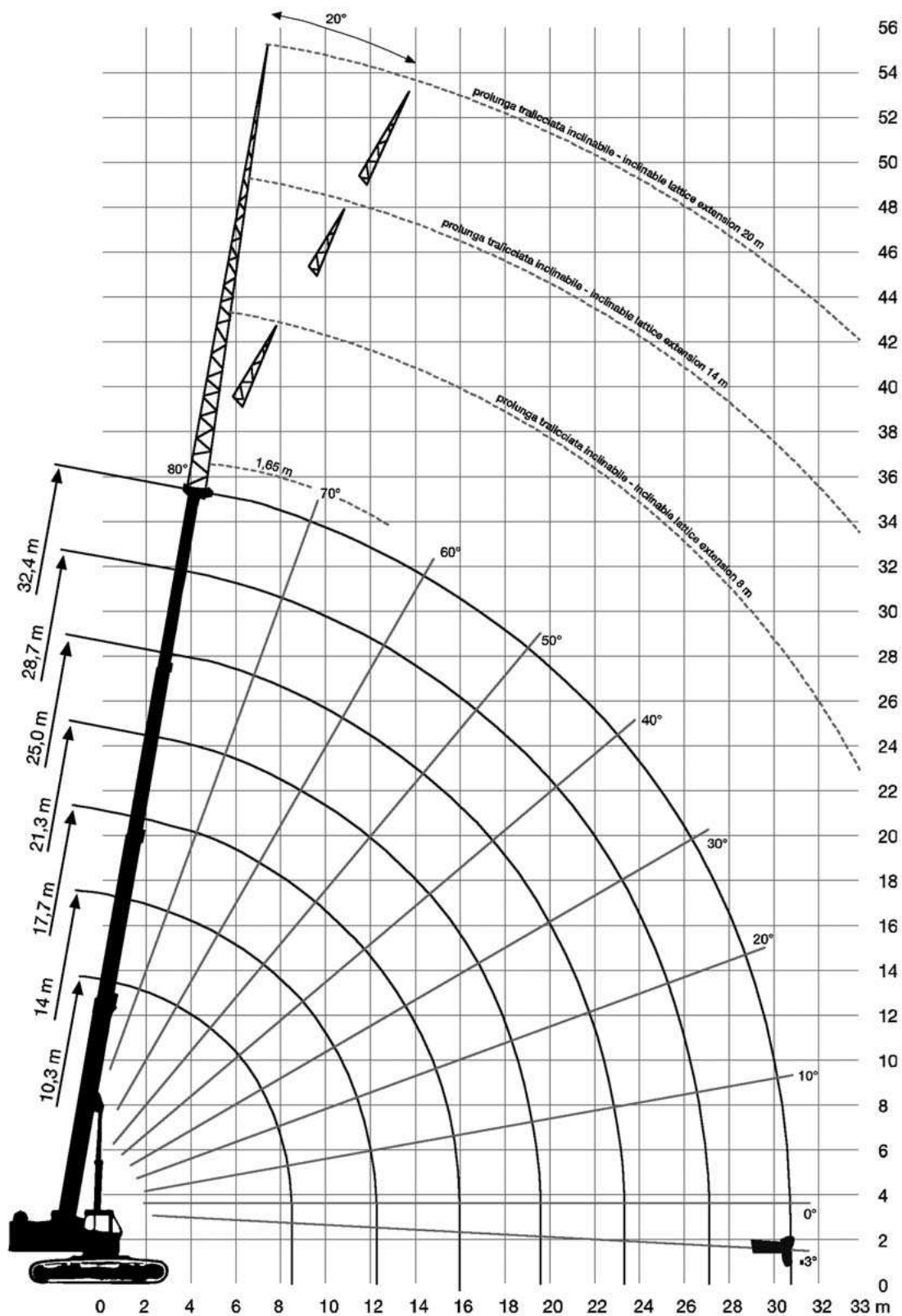
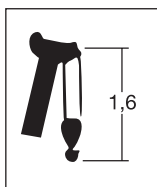
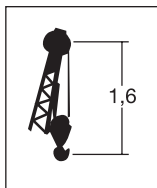
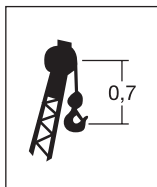
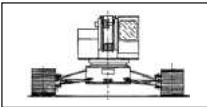

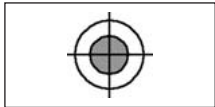
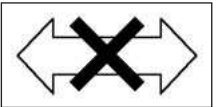







	t2 = 0%	t2 = 50%	t2 = 100%	t2 = 100%	t2 = 100%	t2 = 100%	t2 = 100%	
	t3 = 0%	t3 = 0%	t3 = 0%	t3 = 25%	t3 = 50%	t3 = 75%	t3 = 100%	
	t4 = 0%	t4 = 0%	t4 = 0%	t4 = 25%	t4 = 50%	t4 = 75%	t4 = 100%	
	10.3 m	14.0 m	17.7 m	21.3 m	25.0 m	28.7 m	32.4 m	
								
	60.00	35.00	27.50	20.00	14.50	9.60	6.00	
3.0	60.00							3.0
3.5	49.00							3.5
4.0	45.00	35.00	27.50					4.0
4.5	38.00	34.60	25.50					4.5
5.0	36.00	34.20	23.00	20.00	14.50			5.0
6.0	31.50	32.00	20.50	17.10	13.30	9.60		6.0
7.0	28.00	28.50	18.00	15.00	12.80	8.50	6.00	7.0
8.0	23.00	22.80	16.50	13.50	11.70	8.00	5.70	8.0
9.0		18.90	14.90	12.30	10.60	7.50	5.40	9.0
10.0		16.05	12.80	11.10	9.70	7.00	5.00	10.0
11.0		13.80	11.50	10.00	8.30	6.70	4.70	11.0
12.0		12.05	10.50	9.10	7.60	6.40	4.50	12.0
13.0			9.50	8.30	7.20	6.20	4.30	13.0
14.0			8.50	7.60	6.50	5.80	4.00	14.0
15.0			8.00	6.70	6.00	5.20	3.80	15.0
16.0				6.00	5.30	4.90	3.50	16.0
17.0				5.40	5.00	4.50	3.40	17.0
18.0				5.00	4.60	4.10	3.30	18.0
19.0				4.50	4.20	3.90	3.10	19.0
20.0					3.90	3.60	2.90	20.0
21.0					3.60	3.30	2.70	21.0
22.0					3.30	3.00	2.60	22.0
23.0					3.00	2.80	2.50	23.0
24.0						2.60	2.40	24.0
25.0						2.40	2.20	25.0
26.0						2.20	2.00	26.0
27.0							1.80	27.0
28.0							1.70	28.0
29.0							1.60	29.0
30.0							1.50	30.0
31.0								31.0
32.0								32.0
33.0								33.0

TABELLE / CHART / TABLEAU / TABELLE







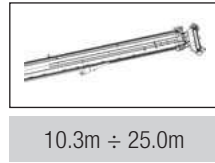
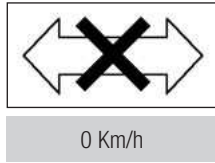
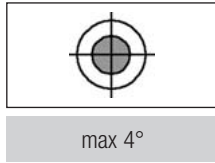
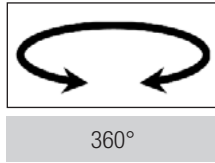
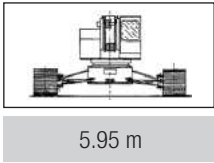













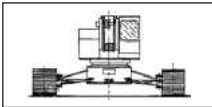

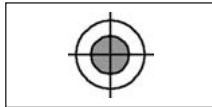
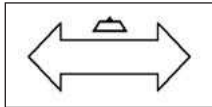
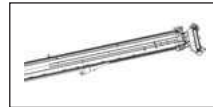
	t2 = 0%	t2 = 50%	t2 = 50%	t2 = 50%	t2 = 50%	
	t3 = 0%	t3 = 0%	t3 = 25%	t3 = 50%	t3 = 75%	
	t4 = 0%	t4 = 0%	t4 = 25%	t4 = 50%	t4 = 75%	
	10.3 m	14.0 m	17.7 m	21.3 m	25.0 m	
						
	49.00	31.80	13.20	8.80	5.80	
3.0	49.00					3.0
3.5	45.00					3.5
4.0	41.00	31.80	13.20			4.0
4.5	38.00	30.80	12.50			4.5
5.0	36.00	29.50	12.00	8.80	5.80	5.0
6.0	30.50	26.50	11.40	8.50	5.60	6.0
7.0	24.90	21.75	10.80	8.30	5.40	7.0
8.0	21.20	18.25	10.00	8.00	5.10	8.0
9.0		15.70	9.40	7.60	4.90	9.0
10.0		13.70	8.60	7.30	4.80	10.0
11.0		12.15	7.90	7.00	4.70	11.0
12.0		11.00	7.30	6.50	4.50	12.0
13.0			6.80	6.10	4.40	13.0
14.0			6.30	5.70	4.20	14.0
15.0			5.90	5.30	4.00	15.0
16.0				4.90	3.90	16.0
17.0				4.60	3.80	17.0
18.0				4.30	3.60	18.0
19.0				4.00	3.40	19.0
20.0					3.20	20.0
21.0					2.90	21.0
22.0					2.70	22.0
23.0					2.60	23.0
24.0						24.0
25.0						25.0
26.0						26.0
27.0						27.0
28.0						28.0
29.0						29.0
30.0						30.0
31.0						31.0
32.0						32.0
33.0						33.0

TABELLE / CHART / TABLEAU / TABELLE

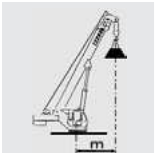
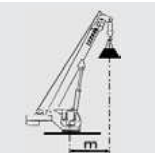
					
5.95m	360°	max 4°	2.5 Km/h	10.3m ÷ 25.0m	

	t2 = 0%	t2 = 50%	t2 = 50%	t2 = 50%	t2 = 50%	
	t3 = 0%	t3 = 0%	t3 = 25%	t3 = 50%	t3 = 75%	
	t4 = 0%	t4 = 0%	t4 = 25%	t4 = 50%	t4 = 75%	
	10.3 m	14.0 m	17.7 m	21.3 m	25.0 m	
						
	38.00	20.45	11.80	7.00	4.90	
3.0	38.00					3.0
3.5	32.40					3.5
4.0	28.45	20.45	11.80			4.0
4.5	25.55	18.75	11.20			4.5
5.0	23.35	17.30	10.80	7.00	4.90	5.0
6.0	20.10	15.10	10.20	6.80	4.70	6.0
7.0	17.95	13.45	9.70	6.60	4.50	7.0
8.0	16.85	12.10	9.00	6.40	4.30	8.0
9.0		11.05	8.40	6.20	4.20	9.0
10.0		10.25	7.70	6.00	4.10	10.0
11.0		9.70	7.10	5.80	4.00	11.0
12.0		9.60	6.50	5.60	3.80	12.0
13.0			6.10	5.30	3.70	13.0
14.0			5.60	5.00	3.60	14.0
15.0			5.30	4.70	3.40	15.0
16.0				4.40	3.30	16.0
17.0				4.00	3.20	17.0
18.0				3.70	3.00	18.0
19.0				3.50	2.90	19.0
20.0					2.70	20.0
21.0					2.50	21.0
22.0					2.30	22.0
23.0					2.20	23.0
24.0						24.0
25.0						25.0
26.0						26.0
27.0						27.0
28.0						28.0
29.0						29.0
30.0						30.0
31.0						31.0

Cingoli aperti Crawler open Chenilles sorties Raupen ausgefahren	Cingoli chiusi Crawler closed Chenilles rentrées Raupen eingefahren	Angolo rotazione sovrastruttura Upperstructure angle rotation Angle rotation structure du dessus Drehwinkel des Strukturaufbaus	Inclinazione massima ammessa della macchina Maximum allowed machine inclination Inclinaison maximum admise de la machine Maximale zugelassene Neigung der Maschine	Braccio telescopico Telescopic boom Flèche télescopique Teleskoparm
Traslazione impedita Transfer disabled Déplacement interdit Transfer gehemmt	Traslazione con carico su 360° Transfer with load over 360° Déplacement avec charge à 360° Transfer mit Last auf 360°	Prolunga / Jib Extension / Jib Extension / Jib Verlängerung / Jib	Non movimentare carichi in queste zone No load handling in these zones Ne pas manipuler de charges dans ces zones Keine Lasten in diesen Bereichen bewegen	

TAGLIE DI SOLLEVAMENTO / HOIST REEVING / MOUFLAGE / HUBROLLEN

N° di taglie / No. of line Nbr. de brins / Seilanzahl	1	2	3	4	5	6	7	8	9	10	11	12
--	---	---	---	---	---	---	---	---	---	----	----	----

ARGANO PRINCIPALE / MAIN WINCH / TREUIL PRINCIPAL / HAUPTWINDE

Carico massimo in kN / Max line pull in kN Charges maxi en kN / Höchstlast in kN	53	103	159	212	265	318	371	424	477	530	583	636
---	----	-----	-----	-----	-----	-----	-----	-----	-----	-----	-----	-----

ARGANO AUSILIARIO / AUXILIARY WINCH / TREUIL AUXILIAIRE / ZUSATZWINDE

Carico massimo in kN / Max line pull in kN Charges maxi en kN / Höchstlast in kN	38	76	114	152	190	228	266	304	342	380	418	456
---	----	----	-----	-----	-----	-----	-----	-----	-----	-----	-----	-----

NOTE

I carichi indicati costituiscono i valori massimi coperti dalla garanzia del costruttore per utilizzo rispettivamente secondo le norme della Unione Europea (CE). Sono espressi in tonnellate metriche ed includono il peso del bozzello, delle eventuali prolunghie applicate al braccio e di tutti gli accessori di sollevamento (brache, ecc.)

Le operazioni di sollevamento nella configurazione su cingoli devono essere effettuate su superficie piana e solida.

NOTES

The indicated loads are the maximum covered by the manufacturer's warranty for a use which complies with current EU directives (CE) standard. Weights are given in metric tons. They include the weight of the block, all extensions fitted to the boom and all lifting accessories (slings and so on).

Crane on tracks: operate the crane on a steady flat surface when hoisting loads.

NOTES

Les charges indiquées constituent les valeurs maximales couvertes par la garantie du fabricant pour une utilisation conforme aux normes de l'Union Européenne. Elles sont exprimées en tonnes métriques et comprennent le poids de la moufle, des éventuelles extensions appliquées à la flèche et de tous les accessoires de levage (élingues, etc.).

Les opérations de levage dans la configuration sur chenilles doivent être effectuées sur une surface plate et solide.

HINWEISE

Die angegebenen Lasten sind die Grenzwerte, für welche die Herstellergarantie bei Einsatz gemäß den Normen der Europäischen Union (EU) gültig ist. Die Grenzwerte sind in Metertonnen ausgedrückt, das Gewicht des Blocks, eventueller am Ausleger angebrachter Verlängerungen und jeglicher Hebezubehörteile (Schlingen usw.) ist inbegriffen.

Hebearbeiten mit Raupenkrane müssen auf einer ebenen und festen Oberfläche erfolgen.

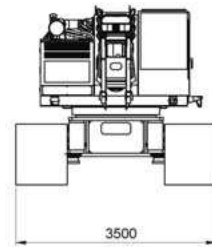
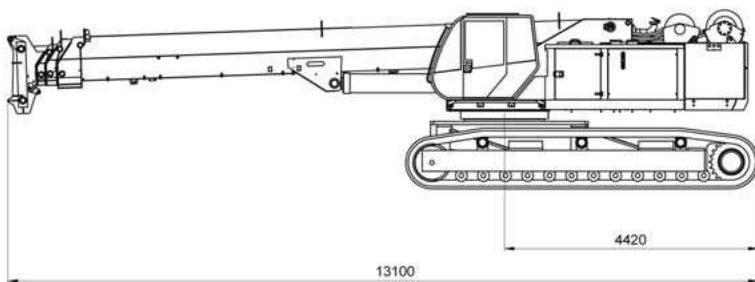
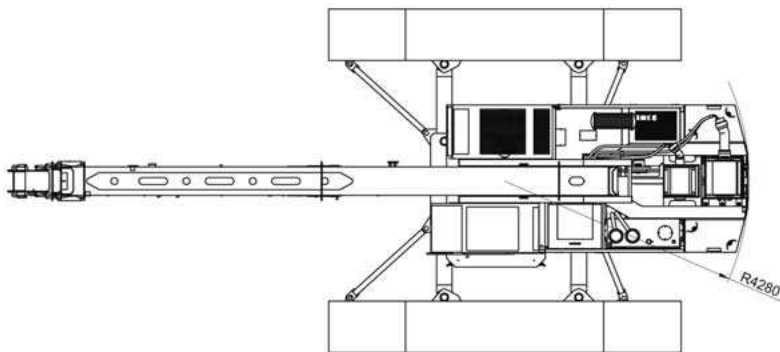
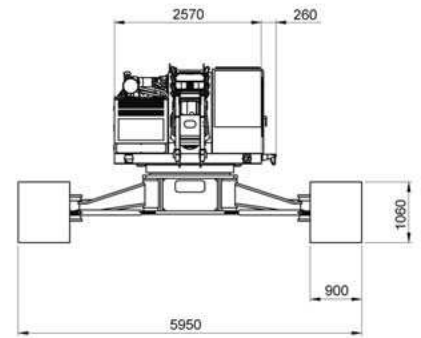
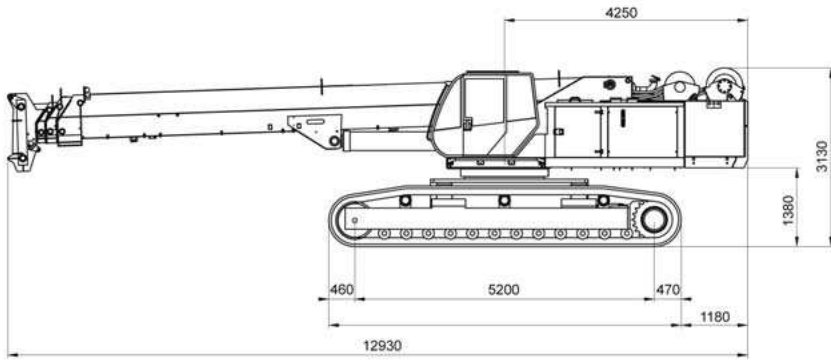

Dimensioni medie di riferimento fornite a puro titolo indicativo. Valori espressi in millimetri
Average reference values, which are indicative only. Values are expressed in mm

Dimensions moyennes de référence fournies à titre purement indicatif. Valeurs exprimées en millimètres
Durchschnittsmaße; dienen ausschließlich als Richtwerte. Die Werte sind in Millimetern ausgedrückt

NOTE	NOTES	NOTES	HINWEISE
<p>Ci riserviamo il diritto di modificare le specifiche e i prezzi dei prodotti in ogni momento e senza preavviso. Le fotografie e/o i disegni contenuti in questo documento sono destinati unicamente a scopi illustrativi. Consultare le istruzioni sull'uso corretto di questo macchinario contenute nell'opportuno Manuale d'uso. L'inottemperanza delle istruzioni contenute nel Manuale d'uso del macchinario e altri comportamenti irresponsabili possono provocare gravi lesioni, anche mortali. L'unica garanzia applicabile ai nostri macchinari è la garanzia scritta standard applicabile al particolare prodotto e alla particolare vendita; Terex è esonerata dal fornire qualsiasi altra garanzia, esplicita o implicita. I prodotti e servizi elencati possono essere dei marchi di fabbrica, marchi di servizio o nomi commerciali di TEREX Corporation e/o società affiliate negli Stati Uniti d'America e altre nazioni e tutti i diritti sono riservati. "TEREX" è un marchio registrato di Terex Corporation negli USA e molti altri Paesi. Copyright © 2007 Terex Corporation.</p>	<p>Product specifications and prices are subject to change without notice or obligation. The photographs and/or drawings in this document are for illustrative purposes only. Refer to the appropriate Operations Manual for instructions on the proper use of this equipment. Failure to follow the appropriate Operations Manual when using our equipment or to otherwise act irresponsibly may result in serious injury or death. The only warranty applicable to our equipment is the standard written warranty applicable to the particular product and sale and Terex makes no other warranty, express or implied. Products and services listed may be trademarks, service marks or trade-names of Terex Corporation and/or its subsidiaries in the USA and other countries. All rights are reserved. Terex® is a registered trademark of Terex Corporation in the USA and many other countries. Copyright 2007 Terex Corporation.</p>	<p>Les spécifications et prix des produits sont sujets à modification sans avis ou obligation. Les photographies et/ou dessins contenus dans ce documents sont uniquement pour illustration. Veuillez vous référer à la notice d'utilisation appropriée pour les instructions quant à l'utilisation correcte de cet équipement. Tout manquement au suivi de la notice d'utilisation appropriée lors de l'utilisation de notre équipement ou tout acte autrement irresponsable peut résulter en blessure corporelle sérieuse ou mortelle. La seule garantie applicable à notre équipement est la garantie standard écrite applicable à un produit et à une vente spécifique. Terex n'offre aucune autre garantie, expresse ou implicite. Les produits et services proposés peuvent être des marques de fabrique, des marques de service ou des appellations commerciales de Terex Corporation et/ou ses filiales aux Etats Unis et dans les autres pays, et tous les droits sont réservés. "TEREX" est une marque déposée de Terex Corporation aux Etats Unis et dans de nombreux autres pays. Copyright 2007 Terex Corporation.</p>	<p>Produktbeschreibungen und Preise können jederzeit und ohne Verpflichtung zur Ankündigung geändert werden. Die in diesem Dokument enthaltenen Fotos und /oder Zeichnungen dienen rein anschaulichen Zwecken. Anweisungen zur ordnungsgemäßen Verwendung dieser Ausrüstung entnehmen Sie bitte dem zugehörigen Betriebshandbuch. Nichtbefolgung des Betriebshandbuchs bei der Verwendung unserer Produkte oder anderweitig fahrlässiges Verhalten kann zu schwerwiegenden Verletzungen oder Tod führen. Für dieses Produkt wird ausschließlich die entsprechende, schriftlich niedergelegte Standardgarantie gewährt. Terex leistet keinerlei darüber hinaus gehende Garantie, weder ausdrücklich noch stillschweigend. Die Bezeichnungen der aufgeführten Produkte und Leistungen sind gegebenenfalls Marken, Servicemarken oder Handelsnamen der Terex Corporation und/oder ihrer Tochtergesellschaften in den USA und anderen Ländern. Alle Rechte vorbehalten. "TEREX" ist eine eingetragene Marke der Terex Corporation in den USA und vielen anderen Ländern. Copyright 2007 Terex Corporation.</p>

