



TEREX® | COMEDIL

Gru a torre "Flat Top"

"Flat Top" Tower Crane • Grue à tour "Flat Top"

"Flat Top" Turmdrehkran • Grúa torre "Flat Top"

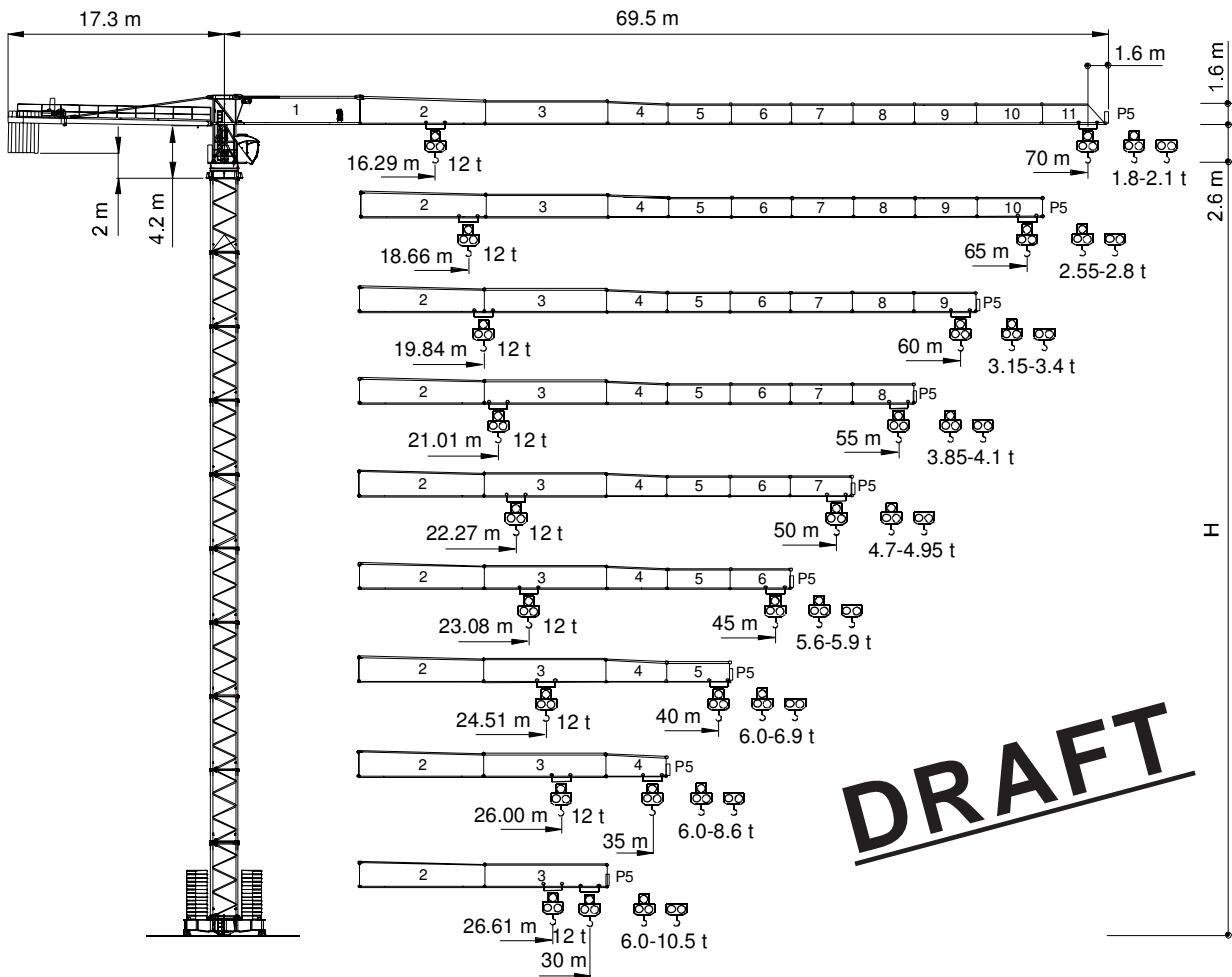

CTT 231-12 TS23

In vigore dal: 01 gennaio 2007. Le specifiche del prodotto ed i prezzi sono soggetti a modifica senza alcun obbligo di preavviso. Le fotografie e/o disegni nel presente documento hanno uno scopo meramente illustrativo. Per il corretto utilizzo di ciascuna attrezzatura, si rimanda allo specifico manuale d'istruzioni. L'inosservanza di quanto previsto nel manuale d'istruzioni nell'utilizzo dell'attrezzatura, così come un comportamento irresponsabile potrebbero causare gravi lesioni o il decesso. Le nostre attrezzature sono coperte solo ed esclusivamente dalla garanzia *standard* scritta prevista per ogni specifico prodotto, con esclusione di qualsivoglia ulteriore garanzia, sia tacita che espressa, da parte di Terex. I prodotti e servizi elencati possono essere marchi di fabbrica, di servizi o ragioni sociali appartenenti a Terex Corporation e/o alle sue affiliate operative sia negli USA che in altri paesi e tutti i diritti s'intendono riservati. "TEREX" è un marchio appartenente a Terex Corporation e registrato sia negli USA che in altri paesi. Copyright © 2007 Terex Corporation.

Effective Date: January 01, 2007. Product specifications and prices are subject to change without notice or obligation. The photographs and/or drawings in this document are for illustrative purposes only. Refer to the appropriate Operator's Manual for instructions on the proper use of this equipment. Failure to follow the appropriate Operator's Manual when using our equipment or to otherwise act irresponsibly may result in serious injury or death. The only warranty applicable to our equipment is the standard written warranty applicable to the particular product and sale and Terex makes no other warranty, express or implied. Products and services listed may be trademarks, service marks or trade-names of Terex Corporation and/or its subsidiaries in the USA and other countries and all rights are reserved. "TEREX" is a registered trademark of Terex Corporation in the USA and many other countries. Copyright © 2007 Terex Corporation.

UTEDOC. REV.000

Courtesy of Crane.Market

Diagramma di portata (I) **Courbes de charges** (F) **Curvas de cargas** (E)
Load Diagram (GB) **Lastkurven** (D)

| i | | CTT 231-12 | | | | | | | | | | |
|------|-----------|-------------------|-------|-------|------|------|------|------|------|------|------|------|
| | | 20 | 25 | 30 | 35 | 40 | 45 | 50 | 55 | 60 | 65 | 70 |
| 6 t | - 30,49 m | 6,00 | 6,00 | 6,00 | 5,10 | 4,34 | 3,76 | 3,29 | 2,91 | 2,59 | 2,33 | 2,10 |
| 6 t | - 29,25 m | 6,00 | 6,00 | 5,82 | 4,80 | 4,04 | 3,46 | 2,99 | 2,61 | 2,29 | 2,03 | 1,80 |
| 12 t | - 16,29 m | 9,45 | 7,26 | 5,82 | 4,80 | 4,04 | 3,46 | 2,99 | 2,61 | 2,29 | 2,03 | 1,80 |
| 6 t | - 34,82 m | 6,00 | 6,00 | 6,00 | 5,96 | 5,10 | 4,43 | 3,90 | 3,46 | 3,10 | 2,80 | |
| 6 t | - 33,73 m | 6,00 | 6,00 | 6,00 | 5,74 | 4,87 | 4,19 | 3,66 | 3,22 | 2,86 | 2,55 | |
| 12 t | - 18,66 m | 11,09 | 8,56 | 6,91 | 5,74 | 4,87 | 4,19 | 3,66 | 3,22 | 2,86 | 2,55 | |
| 6 t | - 37,31 m | 6,00 | 6,00 | 6,00 | 6,00 | 5,53 | 4,82 | 4,25 | 3,79 | 3,40 | | |
| 6 t | - 36,01 m | 6,00 | 6,00 | 6,00 | 6,00 | 5,28 | 4,57 | 4,00 | 3,54 | 3,15 | | |
| 12 t | - 19,84 m | 11,89 | 9,21 | 7,45 | 6,21 | 5,28 | 4,57 | 4,00 | 3,54 | 3,15 | | |
| 6 t | - 39,76 m | 6,00 | 6,00 | 6,00 | 6,00 | 5,96 | 5,20 | 4,59 | 4,10 | | | |
| 6 t | - 38,32 m | 6,00 | 6,00 | 6,00 | 6,00 | 5,70 | 4,94 | 4,34 | 3,85 | | | |
| 12 t | - 21,01 m | 12,00 | 9,85 | 7,99 | 6,68 | 5,70 | 4,94 | 4,34 | 3,85 | | | |
| 6 t | - 42,33 m | 6,00 | 6,00 | 6,00 | 6,00 | 6,00 | 5,59 | 4,95 | | | | |
| 6 t | - 40,78 m | 6,00 | 6,00 | 6,00 | 6,00 | 6,00 | 5,34 | 4,70 | | | | |
| 12 t | - 22,27 m | 12,00 | 10,53 | 8,56 | 7,17 | 6,14 | 5,34 | 4,70 | | | | |
| 6 t | - 44,34 m | 6,00 | 6,00 | 6,00 | 6,00 | 6,00 | 5,90 | | | | | |
| 6 t | - 42,43 m | 6,00 | 6,00 | 6,00 | 6,00 | 6,00 | 5,60 | | | | | |
| 12 t | - 23,08 m | 12,00 | 10,97 | 8,94 | 7,50 | 6,43 | 5,60 | | | | | |
| 6 t | - 40,00 m | 6,00 | 6,00 | 6,00 | 6,00 | 6,00 | | | | | | |
| 6 t | - 40,00 m | 6,00 | 6,00 | 6,00 | 6,00 | 6,00 | | | | | | |
| 12 t | - 24,51 m | 12,00 | 11,74 | 9,57 | 8,04 | 6,90 | | | | | | |
| 6 t | - 35,00 m | 6,00 | 6,00 | 6,00 | 6,00 | | | | | | | |
| 6 t | - 35,00 m | 6,00 | 6,00 | 6,00 | 6,00 | | | | | | | |
| 12 t | - 26,00 m | 12,00 | 12,00 | 10,23 | 8,60 | | | | | | | |
| 6 t | - 30,00 m | 6,00 | 6,00 | 6,00 | | | | | | | | |
| 6 t | - 30,00 m | 6,00 | 6,00 | 6,00 | | | | | | | | |
| 12 t | - 26,61 m | 12,00 | 12,00 | 10,50 | | | | | | | | |

DRAFT

Altre installazioni (I) **Autres implantations** (F) **Otras implantaciones** (E)
Other configurations (GB) **Aufstellmöglichkeiten** (D)

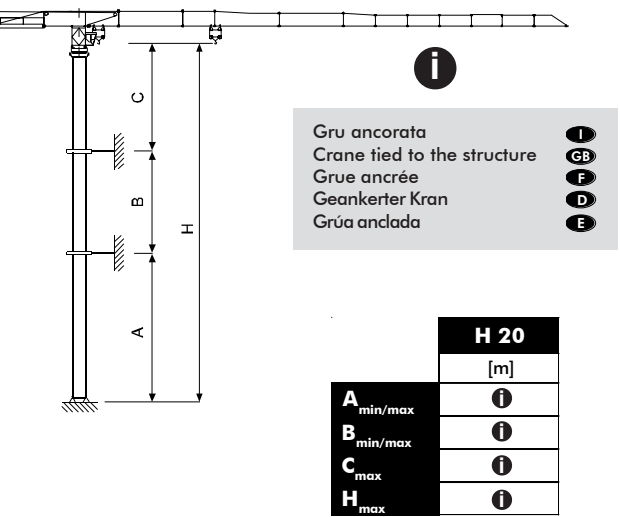
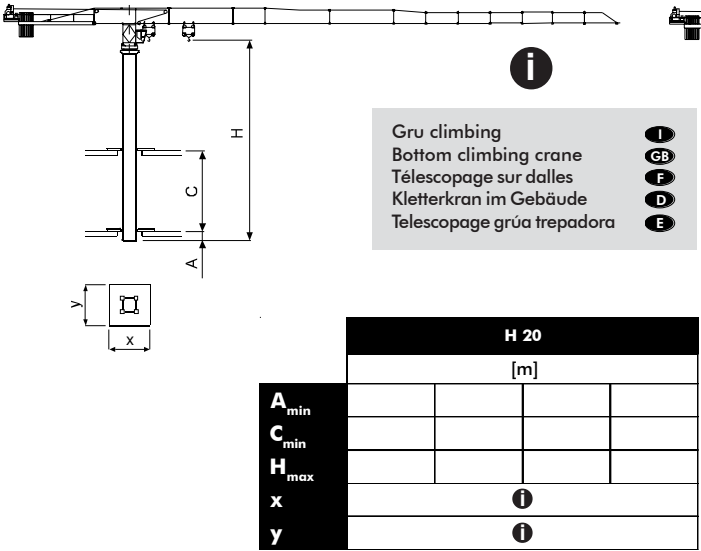

| | | | | | |
|-------|-----------|------|----------|-------|----------|
| Torre | I | Tour | F | Torre | E |
| Tower | GB | Turm | D | | |

TS23

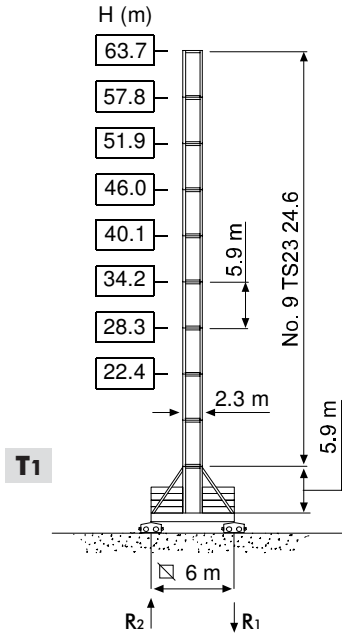
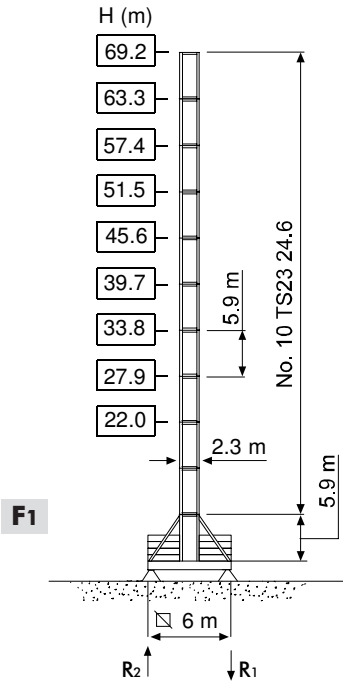
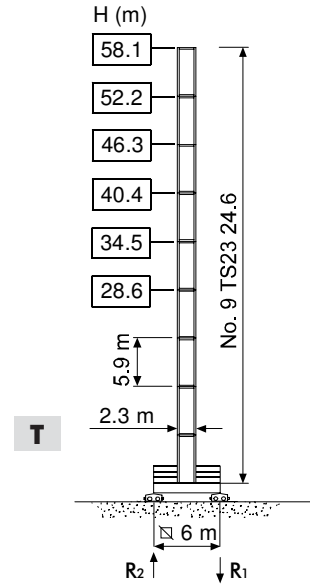
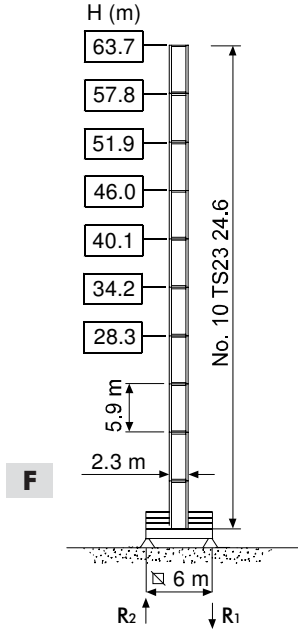
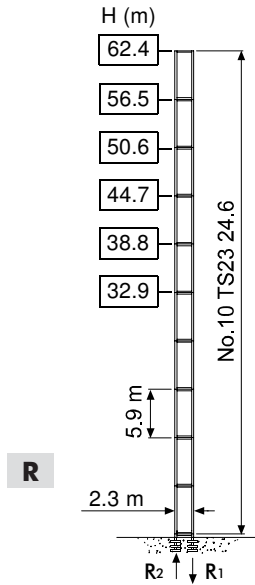

DRAFT

| | |
|------------------------------|-----------|
| Altezza massima sotto gancio | I |
| Max. under hook height | GB |
| H | F |
| Hauteur maxi. sous crochet | F |
| Höchste Hackenhöhe | D |
| Maxima altura bajo gancho | E |

| | | | | | |
|--|-----------|-----------|-------------------------------|--|-----------------------|
| | 45 AFC 60 | 95 * kVA | 400 V - 50 Hz / 460 V - 60 Hz | | 2000/14/CE modificata |
| | 60 AFC 60 | 115 * kVA | | | |

* Gru senza traslazione / Crane without travelling equipment / Grue sans translation / Krane ohne Schienenfahren / Grúa sin traslación

| | | m/min | † | kW | | |
|--|------------------|-------|-----------|-----|----|-----|
| | 45 AFC 60 | | 0 ⇌ 5 | 6 | 45 | 700 |
| | | | 5 ⇌ 15 | 6 | | |
| | | | 15 ⇌ 34 | 6 | | |
| | | | 34 ⇌ 63 | 3 | | |
| | | | 63 ⇌ 124 | 1 | | |
| | | | 0 ⇌ 2 | 12 | | |
| | | | 2 ⇌ 7 | 12 | | |
| | | | 7 ⇌ 17 | 12 | | |
| | | | 17 ⇌ 32 | 6 | | |
| | | | 32 ⇌ 62 | 2 | | |
| | 60 AFC 60 | | 0 ⇌ 5 | 6 | 60 | 700 |
| | | | 5 ⇌ 15 | 6 | | |
| | | | 15 ⇌ 44 | 6 | | |
| | | | 44 ⇌ 106 | 2.3 | | |
| | | | 106 ⇌ 162 | 1.3 | | |
| | | | 0 ⇌ 2 | 12 | | |
| | | | 2 ⇌ 7 | 12 | | |
| | | | 7 ⇌ 22 | 12 | | |
| | | | 22 ⇌ 53 | 4.6 | | |
| | | | 53 ⇌ 81 | 2.6 | | |

| | | | |
|--|----------------------|--|-----------|
| | DVF 3 8 | 0 ⇌ 37 ⇌ 74 m/min | 7.5 kW |
| | SCC 2 2 112 L | 0.88 r.p.m. | 2 x 15 kW |
| | TSR 2RG 4M8 | 12 ⇌ 24 m/min (50 Hz) 14 ⇌ 28 m/min (60 Hz) | 4 x 80 Nm |
| | I | | |

DRAFT

| | | | | | | | | | | |
|--|--------------------------------|----------|--------------------------|-----------|------------------------------------|----------|--|----------|-----------------------------------|----------|
| | Sollevamento | I | Hoisting | GB | Levage | F | Heben | D | Elevación | E |
| | Traslazione carrello | | Trolleying | | Distribution | | Katzfahren | | Distribución | |
| | Rotazione | | Slewing | | Orientation | | Schwenken | | Orientación | |
| | Traslazione | | Travelling | | Translation | | Schienenfahren | | Traslación | |
| | Direttiva sul livello acustico | | Directive on noise level | | Directive sur le niveau acoustique | | Richtlinie für den Schall-Leistungspegel | | Directiva sobre el nivel acustico | |
| | Consultateci | | Consult us | | Nous consulter | | Auf Anfrage | | Consultarnos | |
| | Potenza totale richiesta | | Power requirements | | Puissance totale nécessaire | | Geforderte Stromstärke | | Potencia necesaria | |
| | Alimentazione | | Power supply | | Alimentation | | Stromversorgung | | Alimentación | |

Gru Comedil s.r.l.

A Terex Company



Via S. Egidio 42/A, 33074 Fontanafredda (PN) - Italy
Tel. (+39) 0434 567 311 - Telefax (+39) 0434 998631

Internet e-mail: info@comedil.com
Internet home page: www.comedil.com

Divisione Automontanti

Via Alessandrina, 25 - 20095 Cusano Milanino (MI) - Italy
Tel. (+39) 02 613 16011 - Telefax (+39) 02 613 16034

Internet e-mail: info.CBR@comedil.com