

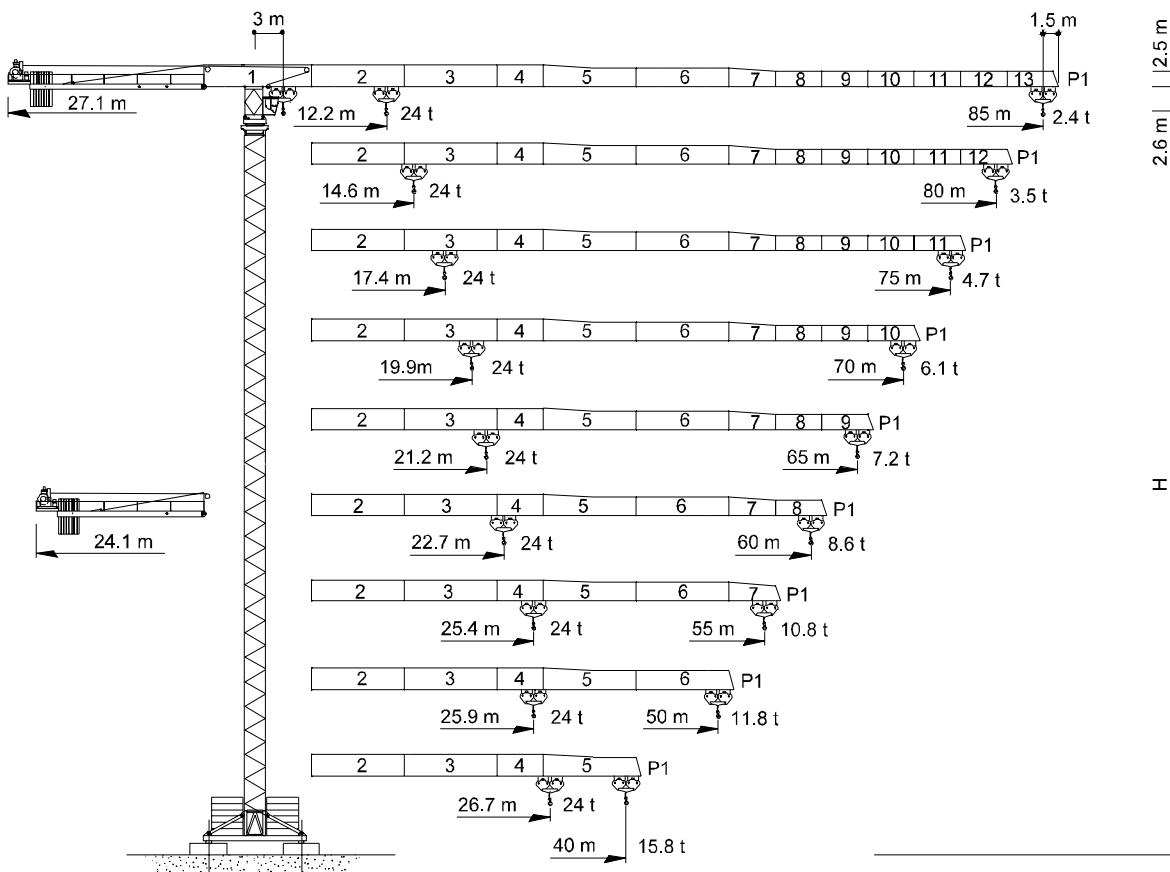

TEREX | COMEDIL

Gru a torre "Flat Top"

"Flat Top" Tower Crane • Grue à tour "Flat Top"
"Flat Top" Turmdrehkran • Grúa torre "Flat Top"



FEM 1.001 A3

THE **ULTIMATE** CRANE™

Dati illustrativi non impegnativi
Con riserva di modifica senza preavviso

Specifications and data not binding
Subject to modification without notice

Données techniques seulement indicatives
Modifications réservées sans préavis

Angaben und Beschreibung unverbindlich
Änderungen vorbehalten ohne weitere Mitteilung

Dibujos y datos sin compromiso
Modificaciones reservadas sin preaviso

UTEDOC. REV.004

CTT 561-24 HD23

Diagramma di portata I
Courbes de charges F
Curvas de cargas E

Load Diagram GB
Lastkurven D

CTT 561-24

m 20 25 30 35 40 45 50 55 60 65 70 75 80 85



12t - 23.1 m
24t - 12.2 m
12t - 28.0 m
24t - 14.6 m
12t - 33.2 m
24t - 17.4 m
12t - 38.2 m
24t - 19.9 m
12t - 41.0 m
24t - 21.2 m
12t - 44.4 m
24t - 22.7 m
12t - 49.9 m
24t - 25.4 m
12t - 50.0 m
24t - 25.9 m
12t - 40.0 m
24t - 26.7 m

t	12	10.95	8.89	7.43	6.35	5.51	4.84	4.30	3.85	3.47	3.14	2.86	2.62	2.40
t	13.29	10.10	8.02	6.54	5.45	4.60	4.93	3.38	2.92	2.54	2.21	1.93	1.68	1.50
t	12	12	11.12	9.35	8.03	7.02	6.21	5.55	5	4.54	4.14	3.80	3.50	
t	16.67	12.83	10.30	8.52	7.20	6.18	5.36	4.70	4.15	3.68	3.29	2.94	2.70	
t	12	12	12	11.31	9.74	8.53	7.57	6.78	6.13	5.58	5.11	4.70		
t	20.48	15.84	12.80	10.65	9.06	7.82	6.84	6.04	5.38	4.82	4.34	4		
t	12	12	12	12	11.42	10.03	8.92	8.02	7.27	6.64	6.10			
t	23.81	18.52	15.05	12.60	10.78	9.37	8.25	7.34	6.58	5.94	5.50			
t	12	12	12	12	12	10.85	9.66	8.69	7.88	7.20				
t	24	19.93	16.21	13.59	11.65	10.14	8.94	7.97	7.16	6.60				
t	12	12	12	12	12	11.81	10.52	9.47	8.60					
t	24	21.56	17.60	14.81	12.73	11.12	9.84	8.80	8.10					
t	12	12	12	12	12	12	11.98	10.80						
t	24	24	19.98	16.84	14.50	12.69	11.26	10.30						
t	12	12	12	12	12	12	12							
t	24	24	20.45	17.24	14.85	13	11.80							
t	12	12	12	12	12									
t	24	24	21.14	17.82	15.80									

Altre installazioni I
Autres implantations F
Otras implantaciones E

Other configurations GB
Aufstellmöglichkeiten D

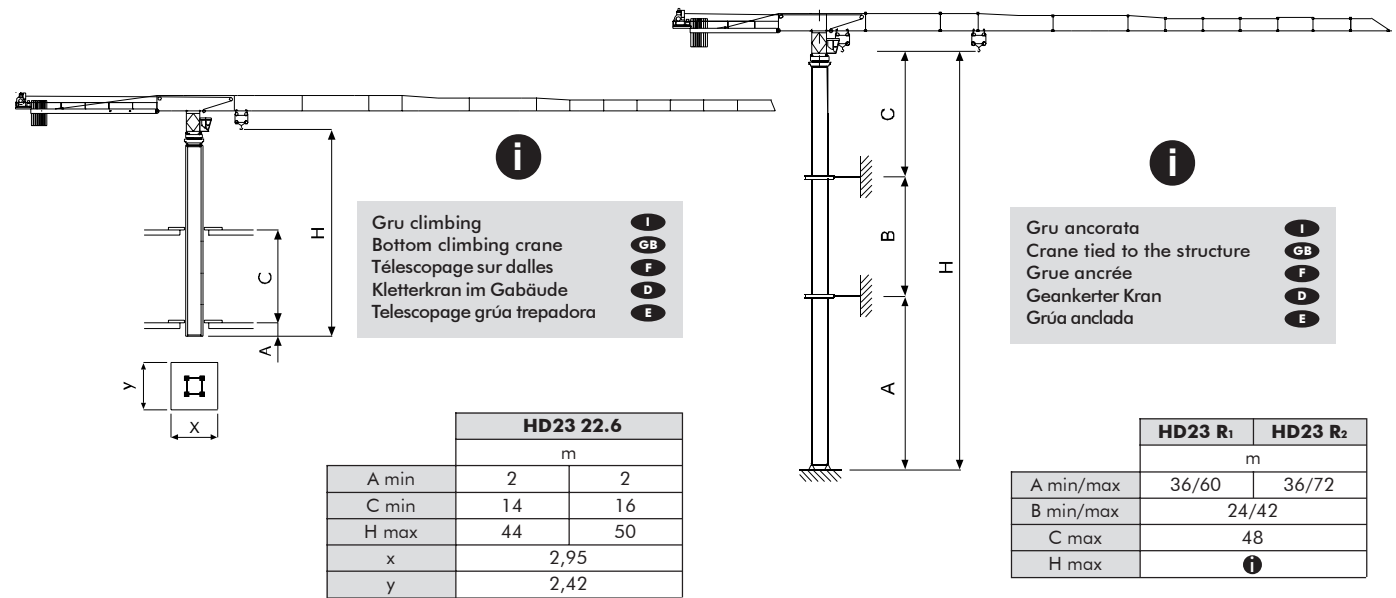

Torre **I** Tower **GB** Tour **F** Turm **D** Torre **E**

HD23

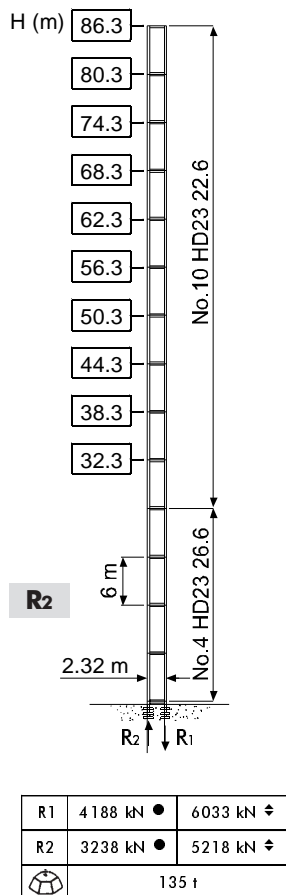
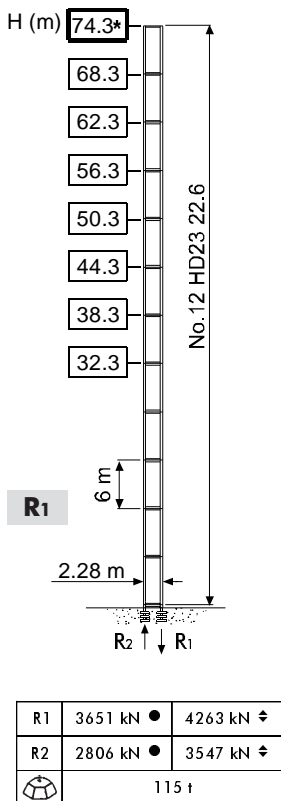
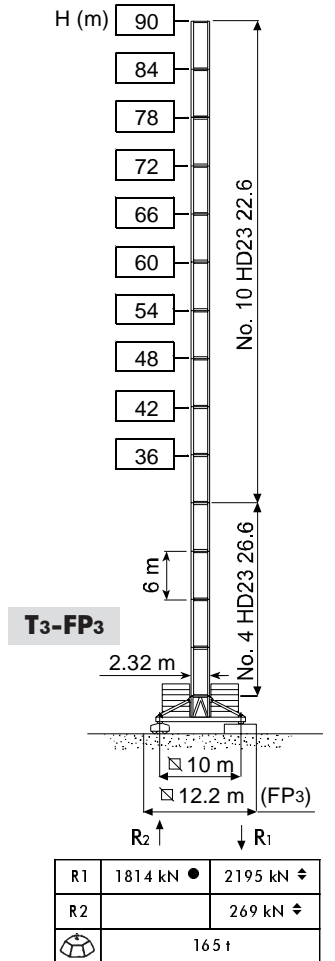
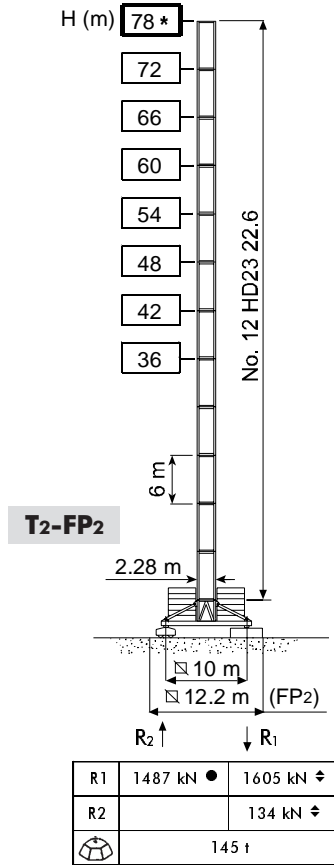
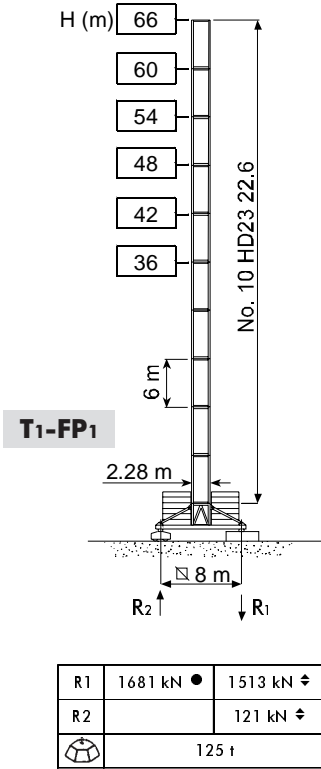

- * (75 m - 80 m - 85 m)
- H** Altezza massima sotto gancio **I**
 - In servizio
 - ◊ Fuori servizio
 - A vuoto, senza zavorra, braccio max., altezza max.
 - H** Max. under hook height **GB**
 - In service
 - ◊ Out of service
 - Without load, without ballast, max. jib and max. height
 - H** Hauteur maxi. sous crochet **F**
 - En service
 - ◊ Hors service
 - A vide, sans lest, avec flèche et hauteur maximum
 - H** Höchste Hackenhöhe **D**
 - In Betrieb
 - ◊ Außer Betrieb
 - Ohne Last und Ballast, mit Maximalausleger und Maximalhöhe
 - H** Maxima altura bajo gancho **E**
 - En servicio
 - ◊ Fuera de servicio
 - Sin carga, sin lastre, con pluma y altura máxima

Meccanismi	I	Mécanismes	F	Mecanismos	E
Mechanisms	GB	Antriebe	D		

216 * kVA	400 V - 50 Hz / 460 V - 60 Hz	2000/14/CE

* Gru senza traslazione / Crane without travelling equipment / Grue sans translation / Krane ohne Schienenfahren / Grúa sin traslación

		m/min	t	kW		
	110 AWL 120 LLC D1 110 AWL 120 LLC D2		0 ⇌ 40	12	110	630 m (LLC D1) 1140 m (LLC D2)
			0 ⇌ 55	8.6		
			0 ⇌ 75	6		
			0 ⇌ 102	4.2		
			0 ⇌ 116	0.6		
			0 ⇌ 20	24		
			0 ⇌ 27.5	17.2		
			0 ⇌ 37.5	12		
			0 ⇌ 51	8.4		
			0 ⇌ 58	1.2		

	DCC 5 112 D2	0 ⇌ 95 m/min	11 kW
	SSR 4 4 80	0.73 r.p.m.	4 × 80 Nm
	▲ TSR 2RG 4M8	12 ⇌ 24 m/min (50 Hz) 14 ⇌ 28 m/min (60 Hz)	4 × 80 Nm
	● TSR 4RG 4M8		
	i		

	▲	●
	Max. H [m]	
T₁	54	> 54
T₂	66	> 66
T₃	-	90

	Sollevamento	I	Hoisting	GB	Levage	F	Heben	D	Elevación	E
	Traslazione carrello		Trolleying		Distribution		Katzfahren		Distribución	
	Rotazione		Slewing		Orientation		Schwenken		Orientación	
	Traslazione		Travelling		Translation		Schienenfahren		Traslación	
	Direttiva sul livello acustico		Directive on noise level		Directive sur le niveau acoustique		Richtlinie für den Schall-Leistungspegel		Directiva sobre el nivel acustico	
	Consultateci		Consult us		Nous consulter		Auf Anfrage		Consultarnos	
	Potenza totale richiesta		Power requirements		Puissance totale nécessaire		Geforderte Stromstärke		Potencia necesaria	
	Alimentazione		Power supply		Alimentation		Stromversorgung		Alimentación	

Gru Comedil s.r.l.

A Terex Company



Via S. Egidio 42/A, 33074 Fontanafredda (PN) - Italy
Tel. (+39) 0434 567 311 - Telefax (+39) 0434 998631

Internet e-mail: info@comedil.com
Internet home page: www.comedil.com

Divisione Automontanti

Via Alessandrina, 25 - 20095 Cusano Milanino (MI) - Italy
Tel. (+39) 02 613 16011 - Telefax (+39) 02 613 16034

Internet e-mail: info.CBR@comedil.com