



ROUGH TERRAIN CRANE RT230-1

DATASHEET - IMPERIAL























RT 230-1

Features:

- ▶ Rated capacity:
30 ton @ 10 ft working radius
- ▶ Maximum boom length:
94 ft
- ▶ Maximum tip height:
140 ft

WORKS FOR YOU.™

	Page:
Key	
.....	3
Dimensions	
Crane dimensions	4
Crane weights	5
Load Charts	
Range Diagram – Main Boom – Outriggers fully extended (100%)	6
Load Chart – Main Boom – Outriggers fully extended (100%)	7
Range Diagram – Main Boom – Outriggers fully retracted (0%)	8
Load Chart – Main Boom – Outriggers fully retracted (0%)	9
Range Diagram – Main Boom – 26 ft offsettable jib	10
Load Chart – Main Boom – 26 ft offsettable jib	11
Range Diagram – Main Boom – 43 ft offsettable jib	12
Load Chart – Main Boom – 43 ft offsettable jib	13
Range Diagram – Main Boom – On tires	14
Load Chart – Main Boom – On tires	15
Technical Description	
Boom	16
Hoist, rope and hook	16, 17
Superstructure	17
Cab, controls, operator aids and load limiter / load indicator	17, 18
Carrier, engine, drive-line and hydraulic system	18
Vehicle performance	19
Tires	19

	Counterweight		General performance
	Main boom		Telescoping mode
	Boom length		Boom luffing angle
	Tip height		Working radius
	Boom with extension		Max. boom length with extension
	Main boom with aux head		Distance from the hook to the head sheave pin
	Slewing / Allowable slewing range		Slewing locked / Slewing locked at specified position
	Slewing brake		Slewing gears
	Outriggers / Lifting on outriggers (100/50/0% extended)		Lifting on wheels / Pick & Carry
	1 Main hoist		2 Auxiliary hoist
	Hoist speed		Rope length
	Rope – Standard / Optional		Max. line pull
	Rope diameter		Tire
	Hook block		Controls
	Cab		Engine
	Operator aids / Load limiter / Load indicator		Steering
	Mechanical transmission		Speed
	HYDR Hydraulics		Heating / Air conditioning
	Working temperature		Gradeability
	Lights		GVW Gross vehicle weight
	Crane / Crane in standard configuration		Weight on front axle
	Crane without counterweight		Weight on rear axle

CRANE DIMENSIONS

RT 230-1

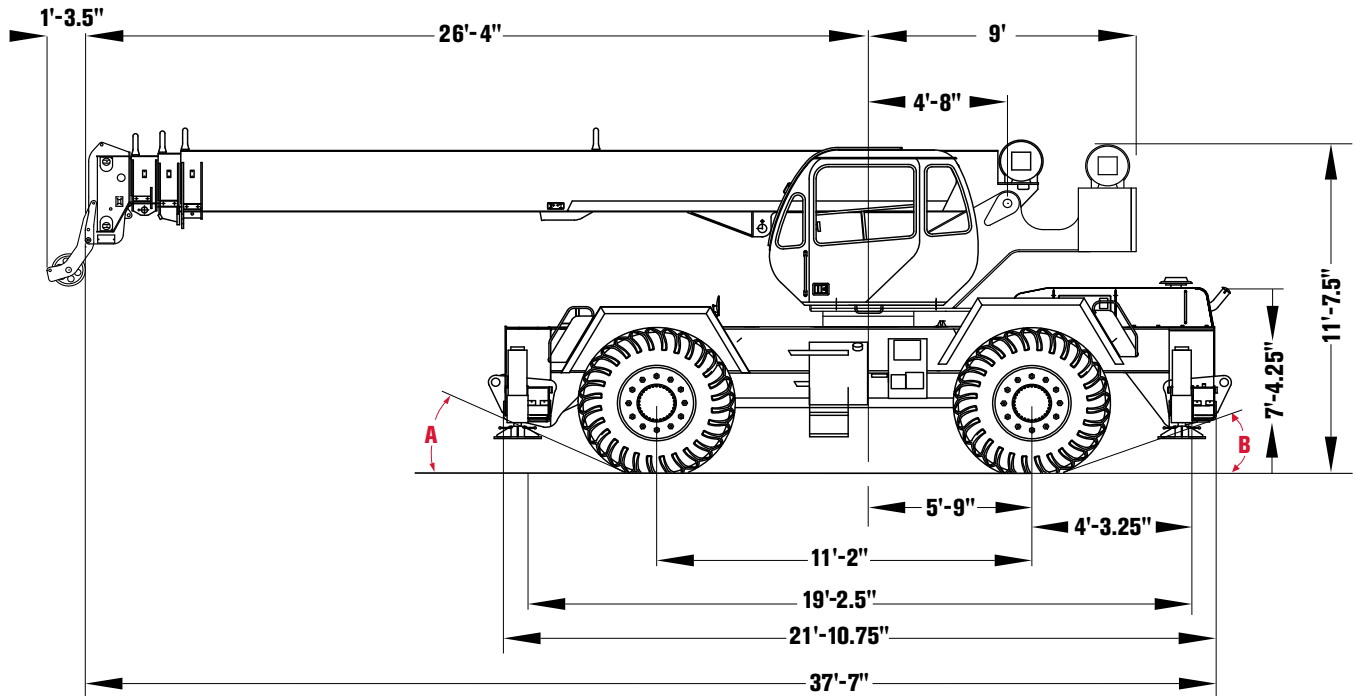

Tire Variances	16.00 x 25	20.5 x 25
A (Approach Angle)	25.1°	25.1°
B (Departure Angle)	23.1°	23.1°
C (Tire Track)	6'-7.5"	6'-10.5"
D (Overall Width)	8'	8'-8"

Note:

All heights are based on 16.00 x 25 tires.



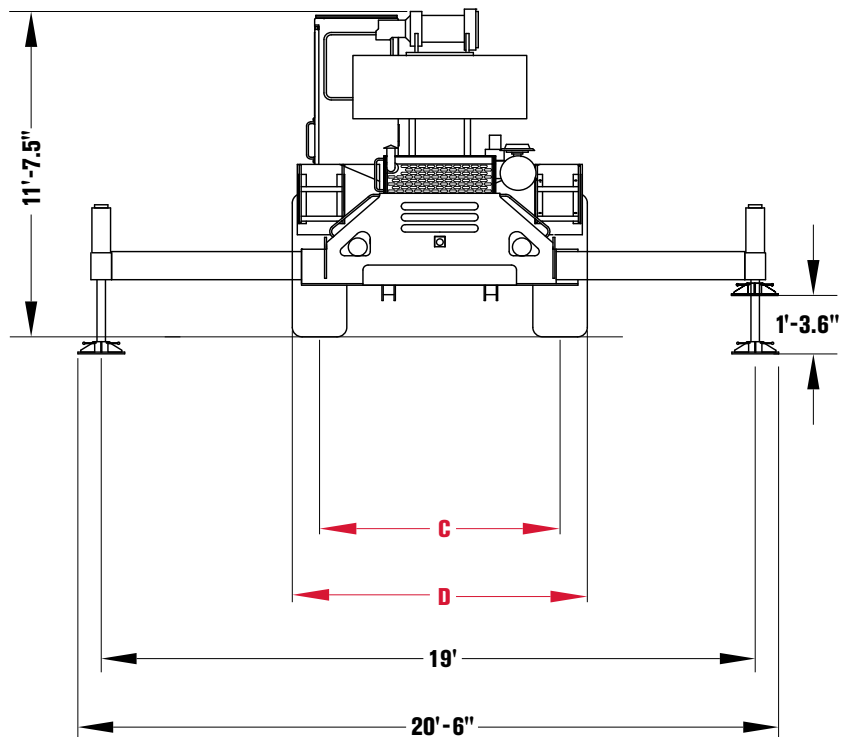





Outrigger Spread	
From Jack CL to Jack CL	
Fully Extended	19'
Mid-Position	13'-2"
Fully Retracted	7'-4.5"

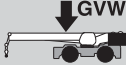
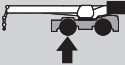
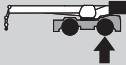
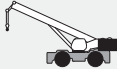

CRANE WEIGHTS

RT 230-1

Approximate Weights

				
		55,930 lb	28,972 lb	26,958 lb
Add / Subtract for main optional equipment				
	26 ft to 43 ft swing on jib stowed	+ 1500 lb	+ 2600 lb	- 1100 lb
	Auxiliary boom head	+ 100 lb	+ 300 lb	- 200 lb
	Auxiliary hoist*	+ 115 lb	- 25 lb	+ 140 lb
	4 sheaves, 30T	+ 655 lb	+ 1071 lb	- 416 lb
	3 sheaves, 30T	+ 670 lb	+ 1099 lb	- 429 lb
	2 sheaves, 25T	+ 682 lb	+ 1117 lb	- 435 lb
	7T Hookball	+ 240 lb	+ 290 lb	- 50 lb

NOTE: Values are subject to 2% variation

* Weight includes rope

RANGE DIAGRAM - MAIN BOOM

RT230-1

Outriggers Fully Extended (100%)

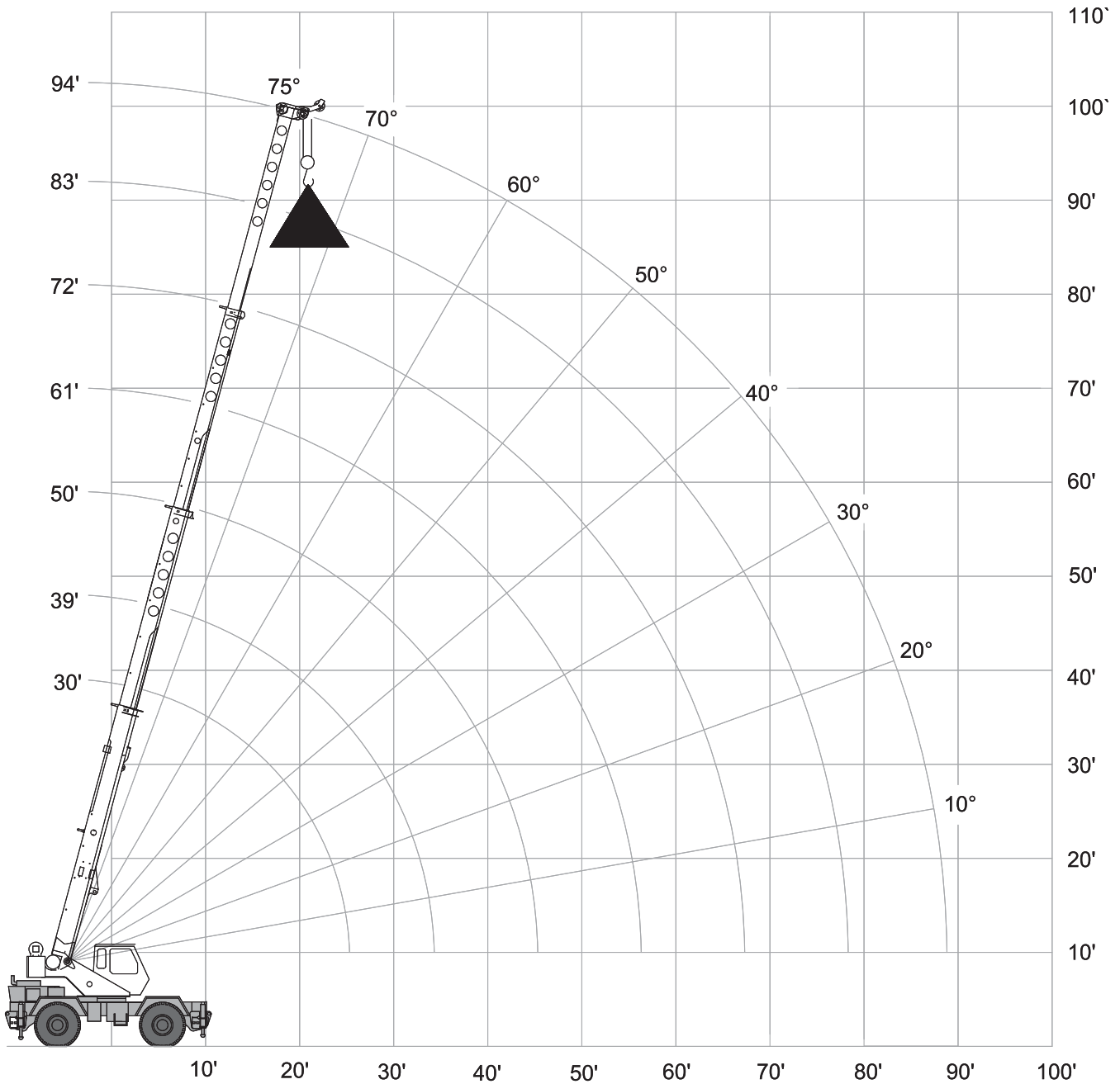
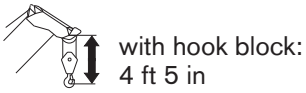
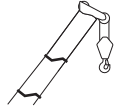



LOAD CHART – MAIN BOOM

RT 230-1

Outriggers Fully Extended (100%)



Standard ASME
B30.5

	Boom Length							
	30.29 ft	39 ft	50 ft	61 ft	72 ft	83 ft	94 ft	
ft	lbs	lbs	lbs	lbs	lbs	lbs	lbs	ft
10	60,000	46,500						10
12	50,000	46,500	44,400					12
15	40,000	39,900	38,400	35,900				15
20	30,000	29,900	29,900	29,400	27,300			20
25	22,700	23,500	23,900	23,900	23,000	18,900	15,200	25
30		18,500	19,000	19,300	19,500	15,800	13,000	30
35			15,000	12,000	15,400	13,700	11,300	35
40			11,700	9,700	12,200	11,900	9,900	40
45			9,200	7,800	9,800	9,900	8,700	45
50				6,400	8,000	8,200	7,800	50
55					6,700	6,800	6,900	55
60					5,500	5,700	5,700	60
65					4,500	4,700	4,800	65
70						4,000	4,100	70
75						3,300	3,400	75
80							2,800	80
85							2,300	85

Notes to lifting capacity

Lifting capacities do not exceed 85% of tipping load. Weight of hook blocks and slings is part of the load, and is to be deducted from the capacity ratings. Consult operation manual for further details.

Note: Data published herein is intended as a guide only and shall not be construed to warrant applicability for lifting purposes. Crane operation is subject to the computer charts and operation manual both supplied with the crane.

RANGE DIAGRAM - MAIN BOOM

RT230-1

Outriggers Fully Retracted (0%)

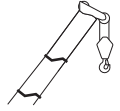

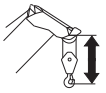
 with hook block:
4 ft 5 in

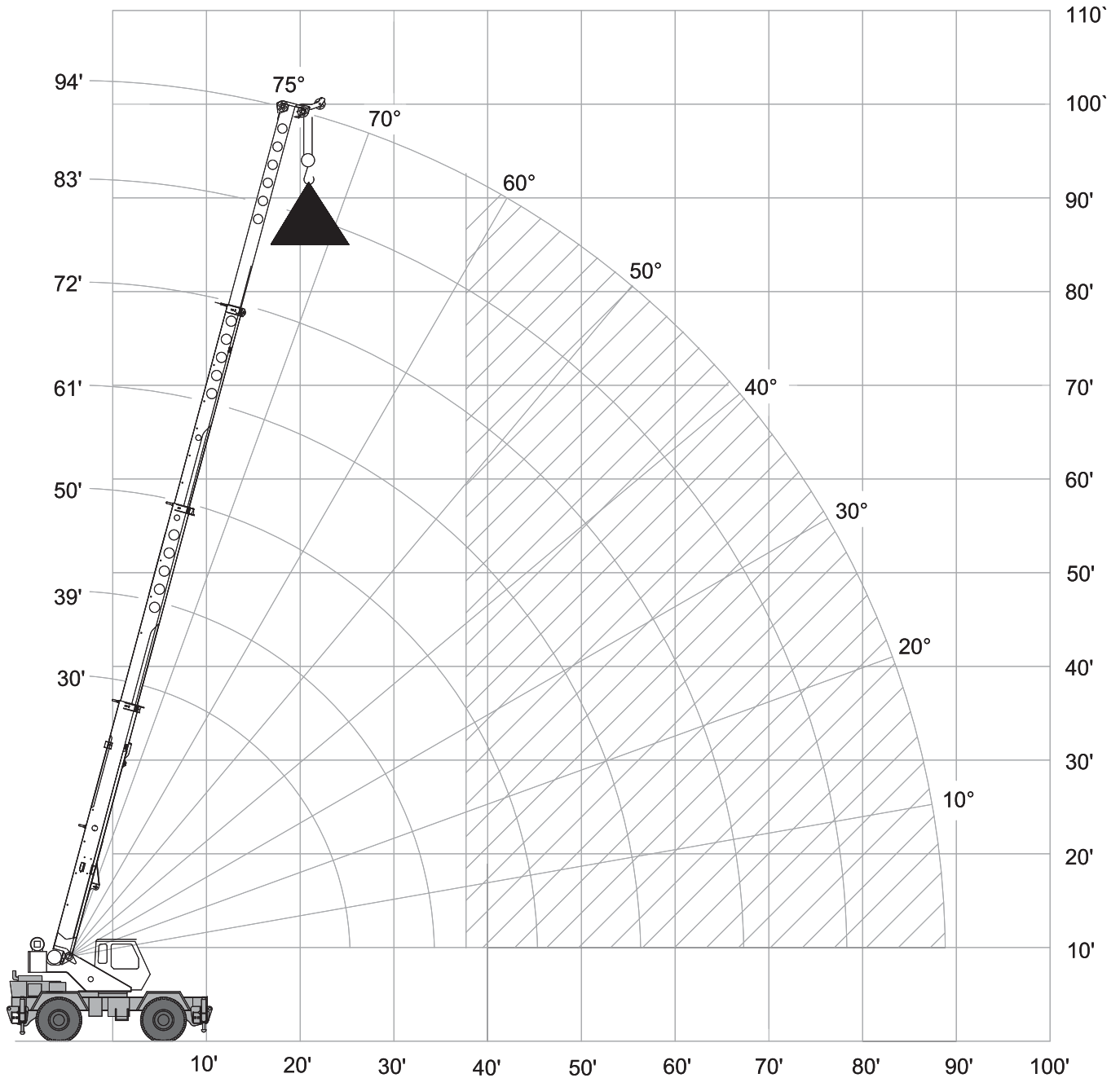

LOAD CHART – MAIN BOOM

RT 230-1

Outriggers Fully Retracted (0%)

 10,000 lbs

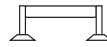
 7 ft 4.5 in (0%)

 360°

Standard ASME
B30.5

	Boom Length							
	30.29 ft	39 ft	50 ft	61 ft	72 ft	83 ft	94 ft	
ft	lbs	lbs	lbs	lbs	lbs	lbs	lbs	ft
10	32,700	33,300						10
12	23,500	24,100	24,500					12
15	15,700	16,400	16,800	17,000				15
20	9,000	9,700	10,200	10,400	10,500			20
25	5,200	6,100	6,600	6,800	7,000	7,100	7,100	25
30		3,800	4,300	4,600	4,800	4,900	5,000	30
35			2,800	3,100	3,300	3,400	3,500	35
40			1,600	2,000	2,200	2,300	2,400	40
45				1,100	1,300	1,400	1,500	45
50						800	900	50

Notes to lifting capacity

Lifting capacities do not exceed 85% of tipping load. Weight of hook blocks and slings is part of the load, and is to be deducted from the capacity ratings. Consult operation manual for further details.

Note: Data published herein is intended as a guide only and shall not be construed to warrant applicability for lifting purposes. Crane operation is subject to the computer charts and operation manual both supplied with the crane.

RANGE DIAGRAM - MAIN BOOM

RT230-1

With Jib, 26 ft offset

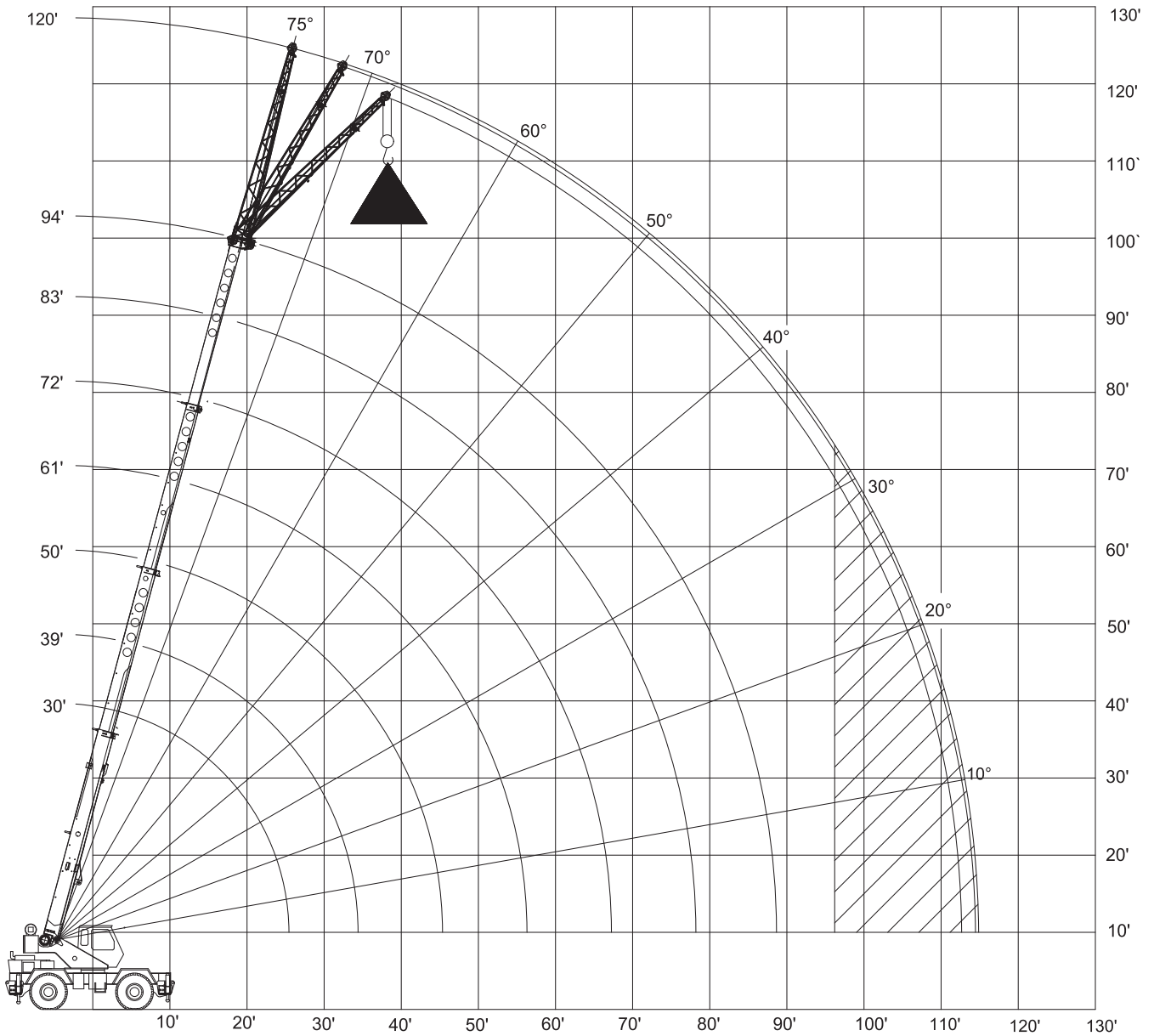
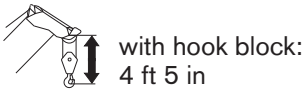
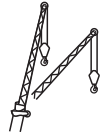



LOAD CHART – MAIN BOOM

RT 230-1

With Jib, 26 ft offset



Standard ASME
B30.5

26 ft Offsettable Jib					
0°		15°		30°	
 ft	lbs	 ft	lbs	 ft	lbs
35	9,000	40	7,300	45	5,500
39	8,500	43	6,700	49	5,200
43	8,000	47	6,200	52	4,900
49	7,200	52	5,500	56	4,400
54	6,200	57	5,000	61	4,000
60	5,400	62	4,500	66	3,600
64	4,700	67	4,000	71	3,300
70	4,000	73	3,500	78	2,900
76	3,400	79	3,100	84	2,700
82	2,700	86	2,500	89	2,400
87	2,200	91	2,100	93	2,200
93	1,700	97	1,700	98	1,700
100	1,300	102	1,300	104	1,300
106	900	108	900		

Notes to lifting capacity

Lifting capacities do not exceed 85% of tipping load. Weight of hook blocks and slings is part of the load, and is to be deducted from the capacity ratings. Consult operation manual for further details.

Note: Data published herein is intended as a guide only and shall not be construed to warrant applicability for lifting purposes. Crane operation is subject to the computer charts and operation manual both supplied with the crane.

RANGE DIAGRAM - MAIN BOOM

RT 230-1

With Jib, 43 ft offset

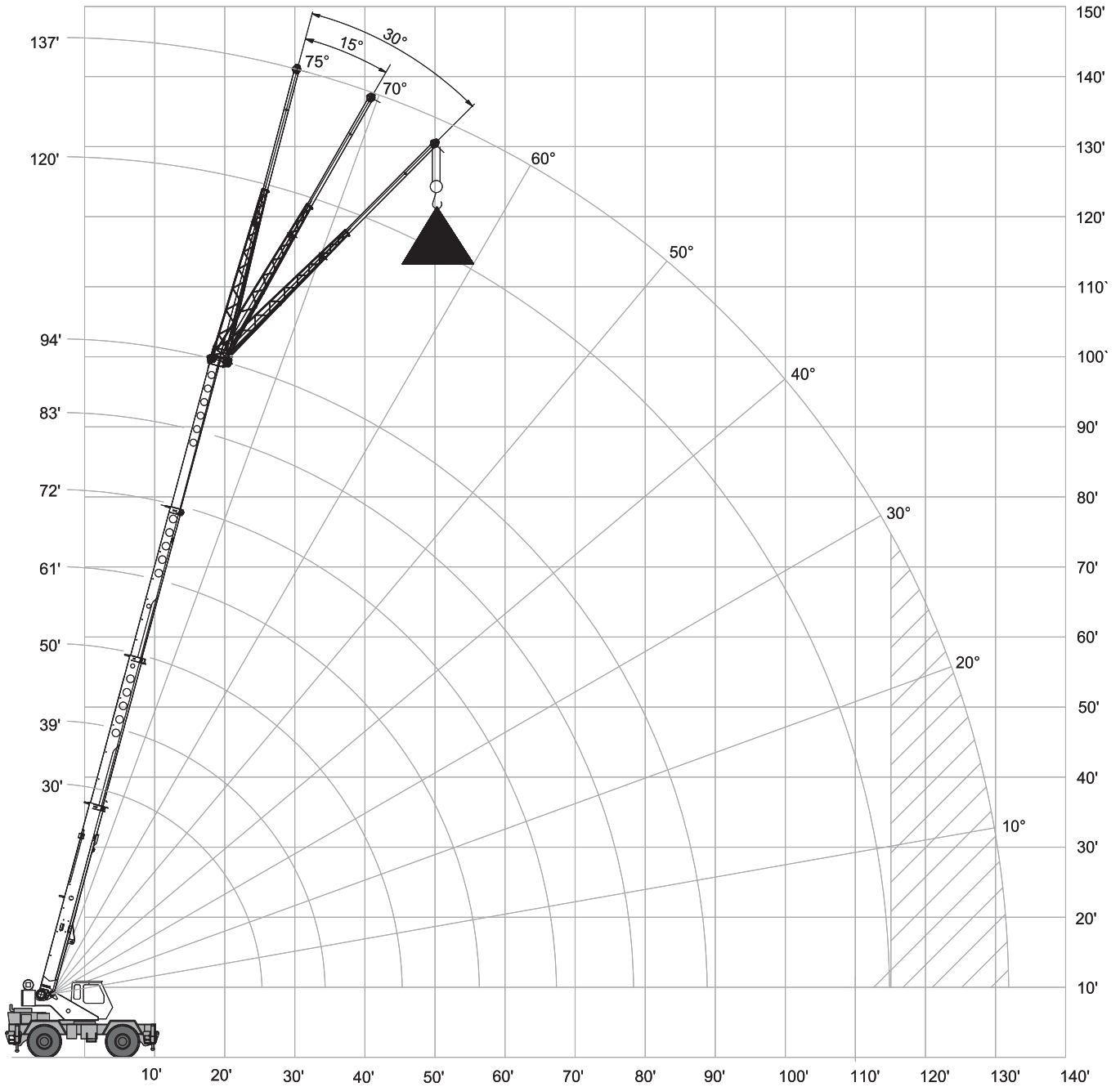
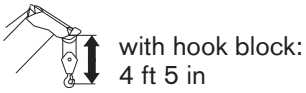
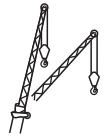

LOAD CHART – MAIN BOOM

RT 230-1



With Jib, 43 ft offset

 10,000 lbs

 19 ft (100%)

 360°

Standard ASME
B30.5

43 ft Offsettable Jib					
0°		15°		30°	
 ft	lbs	 ft	lbs	 ft	lbs
41	5,000	50	3,300	62	2,600
45	4,700	54	3,200	65	2,600
49	4,400	58	3,100	68	2,500
54	4,000	64	2,900	72	2,400
60	3,700	70	2,800	77	2,400
67	3,500	74	2,700	82	2,300
75	3,300	81	2,600	88	2,300
82	3,000	89	2,500	95	2,200
88	2,800	96	2,400	100	2,200
95	2,400	101	2,000	105	1,900
101	2,000	107	1,600	110	1,500
108	1,600	113	1,200	115	1,200
116	1,100	119	900	121	900

Notes to lifting capacity

Lifting capacities do not exceed 85% of tipping load. Weight of hook blocks and slings is part of the load, and is to be deducted from the capacity ratings. Consult operation manual for further details.

Note: Data published herein is intended as a guide only and shall not be construed to warrant applicability for lifting purposes. Crane operation is subject to the computer charts and operation manual both supplied with the crane.

RANGE DIAGRAM - MAIN BOOM

RT230-1

On Tires

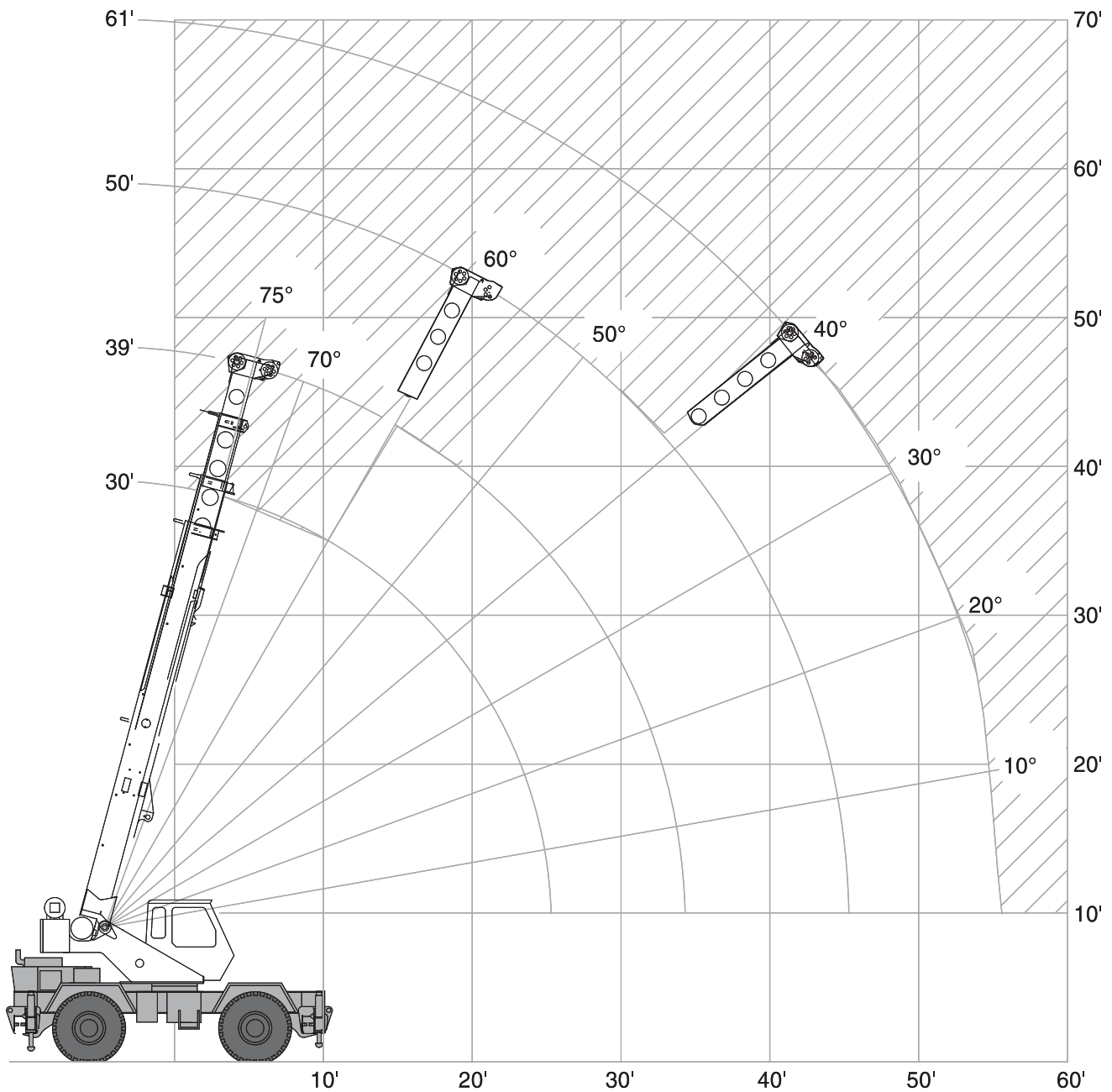
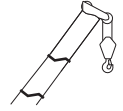
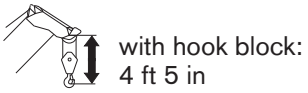

LOAD CHART – MAIN BOOM

RT 230-1

On Tires

 10,000 lbs

 360°

 On tires
20.50 x 25-24 PR

Standard ASME
B30.5

Boom		Travel Speed Boom straight over front		
Radius	Length	0 mph	Creep	2.5 mph
ft	ft	lbs	lbs	lbs
10	30.29	23,900	34,600	23,600
12	30.29	18,900	29,800	20,100
15	39	14,000	24,300	16,000
20	39	8,300	16,500	11,400
25	50	5,300	11,100	8,200
30	50	3,300	8,000	6,200
35	50	1,900	6,000	4,900
40	61	1,200	4,800	3,800
45	61		3,800	3,000
50	61		2,700	2,300
55	61		2,000	1,700
60	72		1,400	1,200
65	72		1,100	800

Notes to lifting capacity







Lifting capacities do not exceed 85% of tipping load. Weight of hook blocks and slings is part of the load, and is to be deducted from the capacity ratings. Consult operation manual for further details.

Note: Data published herein is intended as a guide only and shall not be construed to warrant applicability for lifting purposes. Crane operation is subject to the computer charts and operation manual both supplied with the crane.







TECHNICAL DESCRIPTION





RT 230-1

Boom



Standard configuration:	
	4 sections hydraulic actuated boom
	Full power mechanically synchronized
	Min. / Max. 30 ft / 94 ft
	Boom elevation angle range (min. / max.) -4° / 76°
Optional configuration:	
	Single sheave
	One section, side stowable Angular offsets 0, 15 and 30 degrees
	With one section jib 120 ft With two section jib 147 ft

Hoist, Rope and Hook



Standard configuration:	
	Grooved drum Storage capacity 598 ft
	Two speed ratios Without load in 6 th layer (low range / high range) 297 ft/min / 475 ft/min Without load in 1 st layer (low range / high range) 205 ft/min / 329 ft/min
	6 x 19 IWRC XIPS, right regular lay, preformed
	5/8 in
	479 ft
	Max. line pull; 1 st layer low-range 35,800 lbs Max. line pull permissible 9,000 lbs

Optional configuration:		
	Hook and ball 2 sheaves 3 sheaves 4 sheaves	7 ton 25 ton 30 ton 30 ton
	Grooved drum Storage capacity	598 ft
	Without load in 6 th layer (low range / high range) Without load in 1 st layer (low range / high range)	205 ft/min / 329 ft/min 297 ft/min / 475 ft/min
	Rotation resistant compacted strand 18 x 19 or 19 x 19	
		5/8 in
		479 ft
	Minimum breaking strength Max. line pull permissible	35,800 lbs 9,000 lbs

Superstructure

Standard configuration:		
	Non stop Maximum rotation speed without load	360° 3 rpm
	Hydraulic motor Planetary reducer	
	360° house lock Manually actuated by foot pedal	

Cab, Controls, Operator aids and Load limiter / Load indicator

Standard configuration:		
	Sliding door Tinted safety glass throughout Six way adjustable seat	
	Armrest mounted dual axis electro-proportional joysticks Steering wheel column with gear selector on the left and directional light selector on the right Dashboard mounted switches for outrigger operation	
	Graphic interface for load indicator	

Optional configuration:



Heater
Air conditioner
Work lights
Rotating beacon

Carrier, Engine, Drive-line and Hydraulic system

Standard configuration:



Hydraulic, independent extension:
Diameter of outrigger pads
Area of outrigger pads

24 in
254 in²



Cummins QSB4.5 4 cylinders
Rated power
Maximum gross torque
Intake: turbocharger with intercooler
Fuel type
Fuel tank capacity

130 hp @ 2,300 rpm
459 ft-lb @ 1,500 rpm
Diesel
50 gallons



6 x 6 powershift transmission with integral torque converter
Full time 4WD (Four-Wheel Drive)
Rigid mounted front axle
Oscillating rear axle
Differential lock on front axle and rear axle
Rear axle oscillation lock – manual or automatic actuation
Air-over-hydraulic disc brakes
Parking brake on front axle
Hydraulic oil cooler on carrier



Hydraulic power steering
Front wheel steering
Four wheel steering concentric
Four wheel steering crab
Optional rear wheel steering package



Hydraulic Pumps:

Tandem pumps:

Boom lift / Telescope
Power steering / Outriggers and Swing

39 gal/min @ 3,500 psi
21 gal/min @ 2,500 psi

Single pump:



Main and auxiliary hoist pump

53 gal/min @ 3,500 psi

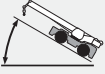

Hydraulic oil reservoir capacity
Hydraulic oil suction filter
Hydraulic oil return filter

94 gallons
250 microns
5 microns

Vehicle performance

	Standard configuration:	
	Max. in 1 st gear	112.34 %
	Max. in 6 th gear	3.77 %
	Max. (6 th gear)	24.5 mph

Tires

	Standard configuration:	
	Wide tread earth mover pattern (E3)	20.5 x 25-26 PR
	Optional configuration:	
	Wide tread earth mover pattern (E3)	16.00 x 25-28 PR

Lined area for notes, consisting of multiple horizontal lines on a light gray background.

www.terexcranes.com

Effective Date: October 2010.

Product specifications and prices are subject to change without notice or obligation. The photographs and/or drawings in this document are for illustrative purposes only. Refer to the appropriate Operator's Manual for instructions on the proper use of this equipment. Failure to follow the appropriate Operator's Manual when using our equipment or to otherwise act irresponsibly may result in serious injury or death. The only warranty applicable to our equipment is the standard written warranty applicable to the particular product and sale and Terex makes no other warranty, express or implied. Products and services listed may be trademarks, service marks or trade-names of Terex Corporation and/or its subsidiaries in the USA and other countries. All rights are reserved. Terex® is a registered trademark of Terex Corporation in the USA and many other countries.

Copyright 2010 Terex Corporation

Terex Cranes, Global Marketing, Dinglerstraße 24, 66482 Zweibrücken, Germany
Tel. +49 (0) 6332 830, Email: info.cranes@terex.com, www.terexcranes.com

Brochure Reference: TC-DS-I-E-RT230-1-10/10



WORKS FOR YOU.™