



**RT 780-1**  
80 US t Lifting Capacity  
Rough Terrain Cranes  
Datasheet  
Imperial

# RT 780-1



## Features

- ▶ Rated capacity:  
80 US t @ 10 ft working radius
- ▶ Maximum boom length:  
126 ft
- ▶ Maximum tip height:  
190 ft

**WORKS FOR YOU.™**

## Key

..... 3

## Dimensions



























Crane dimensions ..... 4  
Crane weights ..... 5

## Load charts

Range Diagram – Main Boom – Outriggers fully extended (100%) ..... 6  
Load Chart – Main Boom – Outriggers fully extended (100%) ..... 7  
Range Diagram – Main Boom – Outriggers fully retracted (0%) ..... 8  
Load Chart – Main Boom – Outriggers fully retracted (0%) ..... 9  
Range Diagram – Main Boom – 33 ft offsettable jib ..... 10  
Load Chart – Main Boom – 33 ft offsettable jib ..... 11  
Range Diagram – Main Boom – 57 ft offsettable jib ..... 12  
Load Chart – Main Boom – 57 ft offsettable jib ..... 13  
Range Diagram – Main Boom – On tires ..... 14  
Load Chart – Main Boom – On tires ..... 15

## Technical description

Boom ..... 16  
Hoist, rope and hook ..... 16, 17  
Superstructure ..... 17  
Cab, controls, operator aids and load limiter / load indicator ..... 18  
Carrier, engine, drive-line and hydraulic system ..... 18, 19  
Vehicle performance ..... 19  
Tires ..... 19

	Counterweight		General performance
	Main boom		Telescoping mode
	Boom length		Boom luffing angle
	Tip height		Working radius
	Boom with extension		Max. boom length with extension
	Main boom with aux head		Distance from the hook to the head sheave pin
	Slewing / Allowable slewing range		Slewing locked / Slewing locked at specified position
	Slewing brake		Slewing gears
	Outriggers / Lifting on outriggers (100/50/0% extended)		Lifting on wheels / Pick & Carry
	Main hoist		Auxiliary hoist
	Hoist speed		Rope length
	Rope - Standard / Optional		Max. line pull
	Rope diameter		Tire
	Hook block		Controls
	Cab		Engine
	Operator aids / Load limiter / Load indicator		Steering
	Mechanical transmission		Speed
	HYDR Hydraulics		Heating / Air conditioning
	Working temperature		Gradeability
	Lights		Gross vehicle weight
	Crane / Crane in standard configuration		Weight on front axle
	Crane without counterweight		Weight on rear axle

# CRANE DIMENSIONS

**RT 780-1**

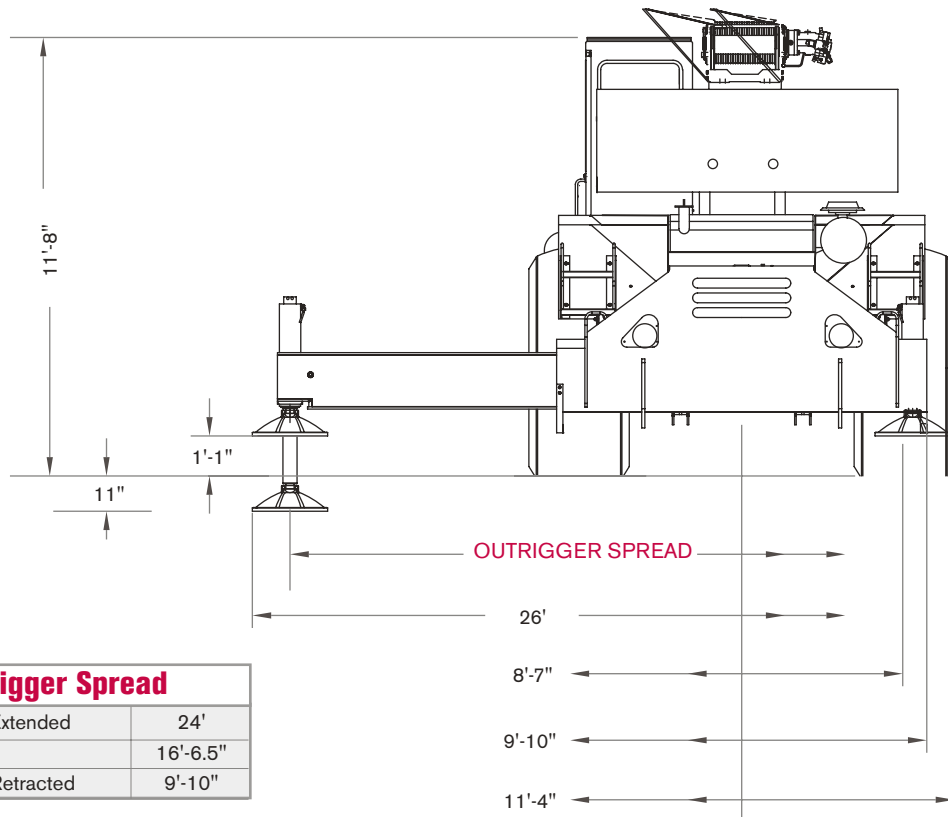
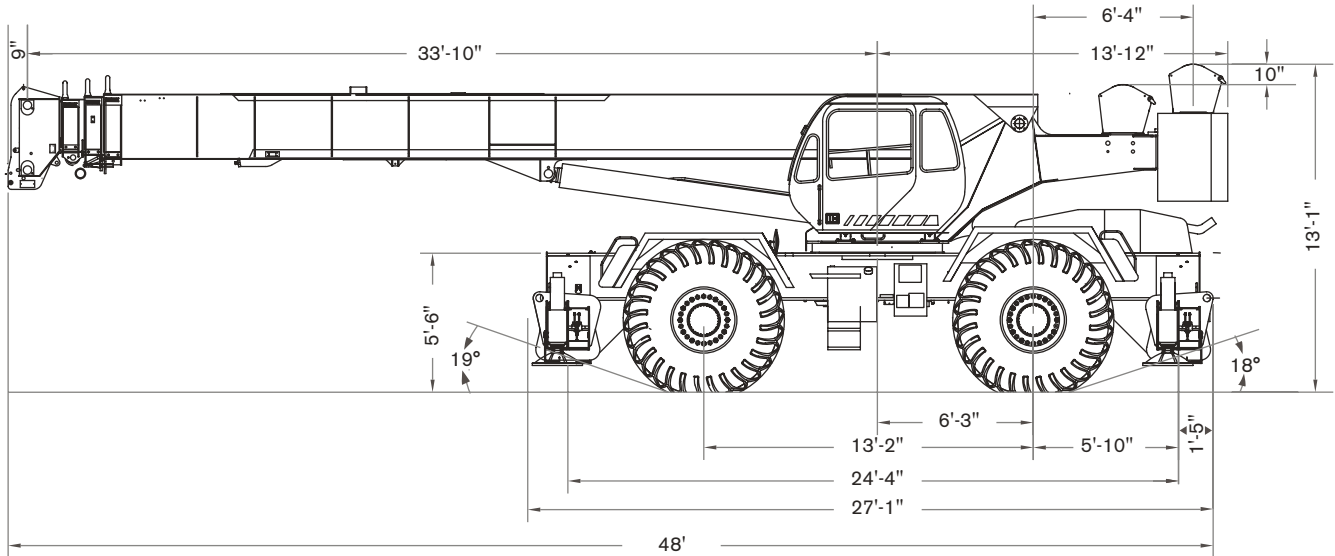







<b>Outrigger Spread</b>	
Fully Extended	24'
Half	16'-6.5"
Fully Retracted	9'-10"

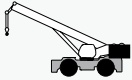

# CRANE WEIGHTS

**RT 780-1**

## Approximate Weights

		↓ GVW	↑	↑
	STD	91,216 lb	47,047 lb	44,169 lb
Add / Subtract for main optional equipment				
	33 ft to 57 ft swing on jib stowed	+ 2,170 lb	+ 3,992 lb	- 1,822 lb
	Auxiliary boom head	+ 125 lb	+ 406 lb	- 281 lb
	Auxiliary hoist*	+ 134 lb	- 35 lb	+ 159 lb
	5 sheaves, 75 USt	+ 1,608 lb	+ 3,447 lb	- 1,839 lb
	5 sheaves, 60 USt	+ 1,204 lb	+ 2,581 lb	- 1,377 lb

NOTE: Values are subject to 2% variation

\* Weight includes rope

# RANGE DIAGRAM - MAIN BOOM

**RT 780-1**

**Outriggers Fully Extended (100%)**

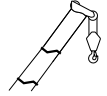

 with hook block:  
6 ft 9 in

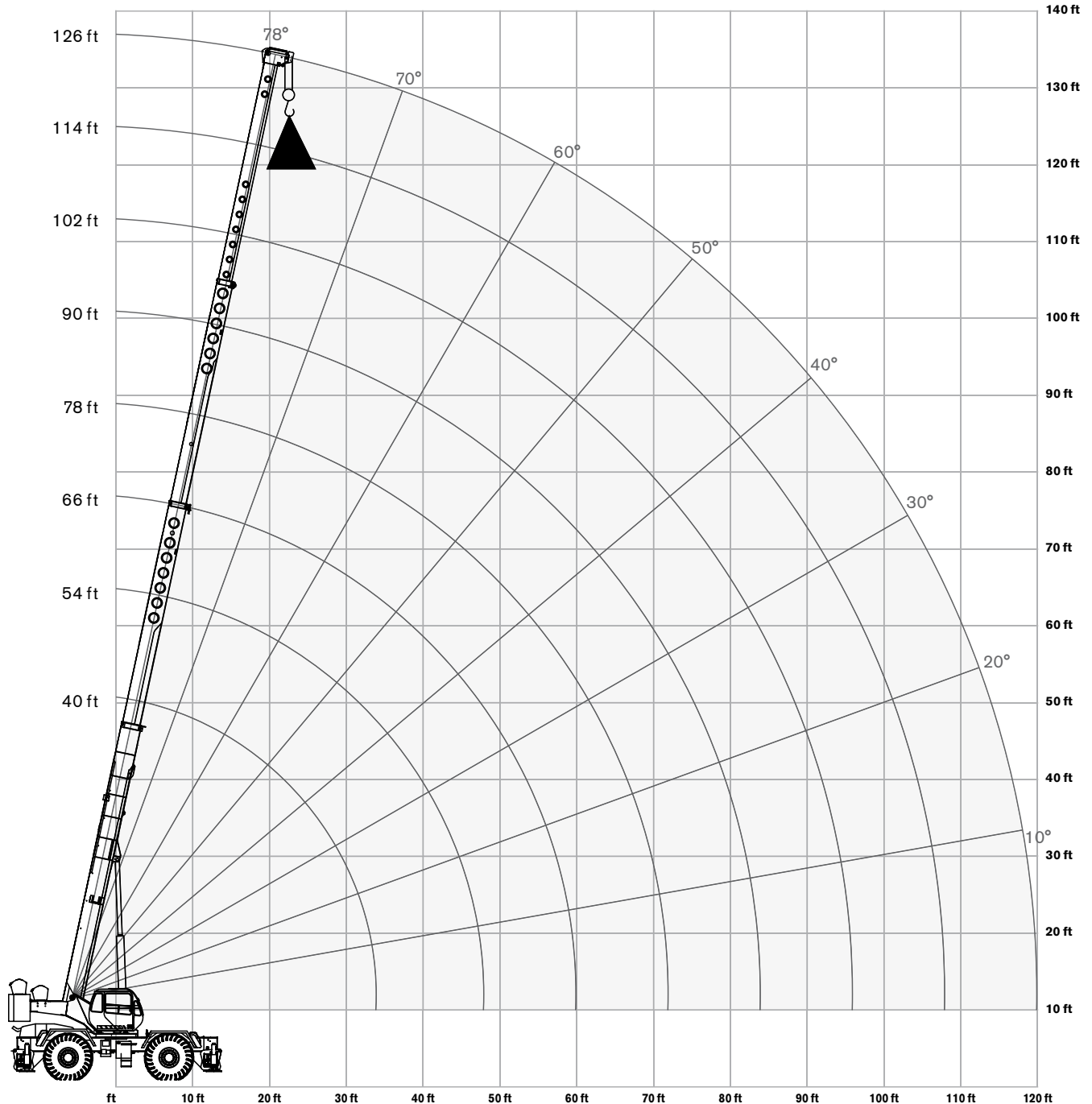



# LOAD CHART- MAIN BOOM

**RT 780-1**

## Outriggers Fully Extended (100%)

 15,200 lbs counterweight

 Outriggers extended 24 ft (100%)

 360 degree rotation

Standard ASME B30.5

	Boom Length								
	40 ft	54 ft	66 ft	78 ft	90 ft	102 ft	114 ft	126 ft	
ft	lb	lb	lb	lb	lb	lb	lb	lb	ft
10	160,000	102,500							10
12	125,600	102,500							12
15	108,800	100,500	80,600						15
20	84,700	85,300	71,900	62,200	56,200				20
25	65,600	66,700	64,800	55,700	48,000	41,900			25
30	49,200	50,500	51,000	49,700	41,700	36,400	31,500		30
35		37,700	38,200	38,500	36,600	32,100	29,500	24,700	35
40		29,400	29,900	30,200	30,400	28,600	26,200	24,600	40
45		23,500	24,100	24,400	24,600	24,700	23,500	22,100	45
50			19,800	20,200	20,300	20,500	20,600	20,000	50
55			16,400	16,900	17,100	17,200	17,300	17,400	55
60				14,200	14,500	14,600	14,700	14,800	60
65				12,100	12,300	12,500	12,600	12,700	65
70				10,300		10,800	10,900	10,900	70
75						9,200	9,400	9,400	75
80						7,900	8,100	8,200	80
85						6,800	6,900	7,100	85
90						5,800	6,000	6,100	90
95						4,900	5,100	5,200	95
100							4,300	4,400	100
105							3,600	3,700	105
110								3,100	110
115								2,500	115

### Notes to lifting capacity

Lifting capacities do not exceed 85% of tipping load. Weight of hook blocks and slings is part of the load, and is to be deducted from the capacity ratings. Consult operation manual for further details.

Note: Data published herein is intended as a guide only and shall not be construed to warrant applicability for lifting purposes. Crane operation is subject to the computer charts and operation manual both supplied with the crane.

# RANGE DIAGRAM - MAIN BOOM

RT 780-1

Outriggers Fully Retracted (0%)



 with hook block:  
6 ft 9 in

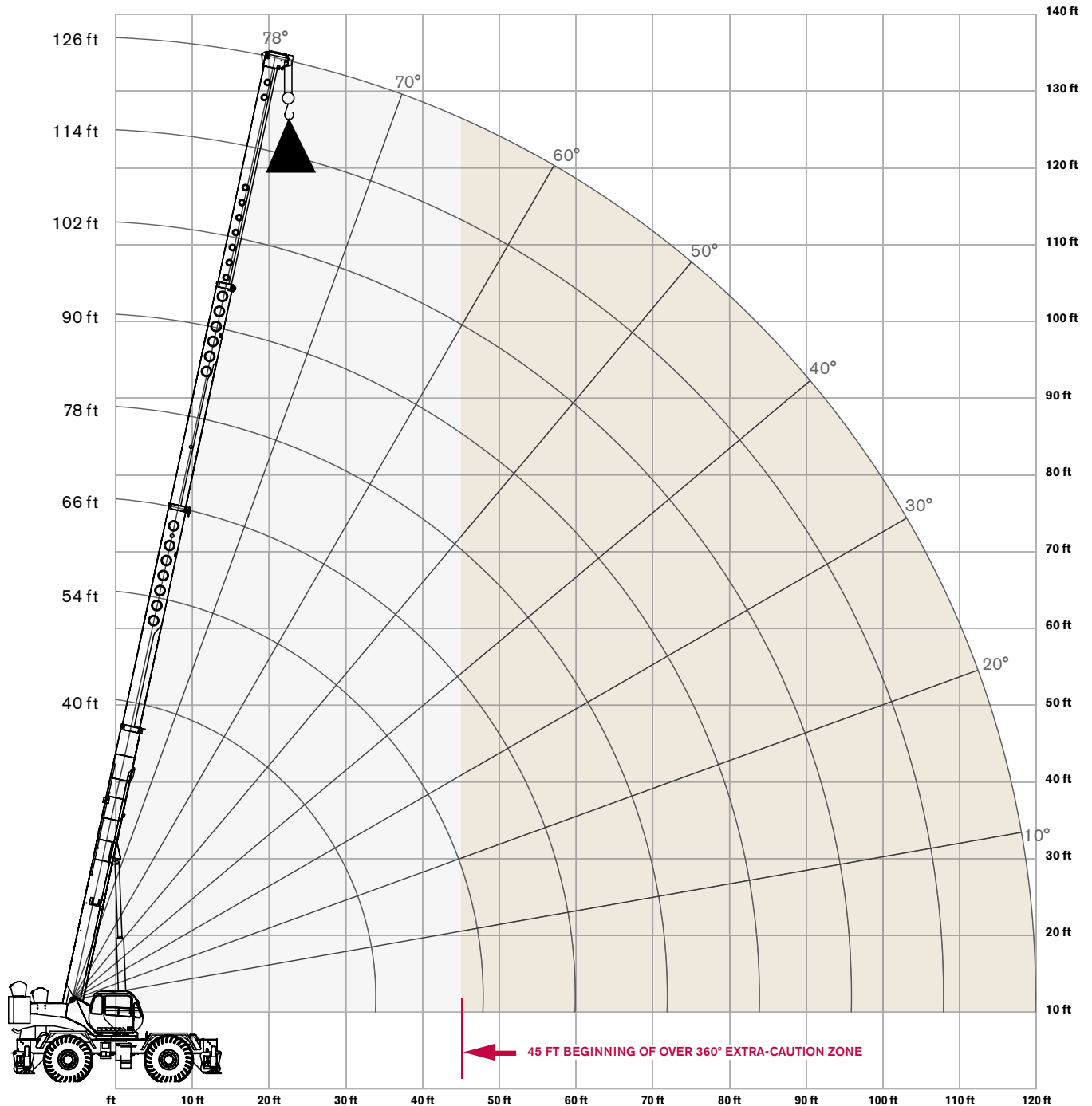





# LOAD CHART- MAIN BOOM

**RT 780-1**

## Outriggers Fully Retracted (0%)

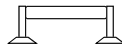
 15,200 lbs counterweight

 Outriggers retracted 9 ft 10 in (0%)

 360 degree rotation

Standard ASME B30.5

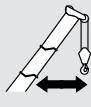
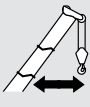
	Boom Length								
	40 ft	54 ft	66 ft	78 ft	90 ft	102 ft	114 ft	126 ft	
ft	lb	lb	lb	lb	lb	lb	lb	lb	ft
10	84,500	85,600							10
12	59,300	60,300							12
15	39,300	40,400	40,800						15
20	23,200	24,300	24,800	25,000	25,200				20
25	14,900	16,000	16,500	16,800	17,000	17,000			25
30	9,800	10,900	11,400	11,800	12,000	12,000	12,100		30
35		7,500	8,000	8,400	8,600	8,600	8,800	8,900	35
40		5,000	5,600	5,900	6,100	6,100	6,300	6,500	40
45		3,200	3,700	4,000	4,300	4,300	4,500	4,700	45
50							3,000	3,300	50

## Notes to lifting capacity

Lifting capacities do not exceed 85% of tipping load. Weight of hook blocks and slings is part of the load, and is to be deducted from the capacity ratings. Consult operation manual for further details.

Note: Data published herein is intended as a guide only and shall not be construed to warrant applicability for lifting purposes. Crane operation is subject to the computer charts and operation manual both supplied with the crane.

# RANGE DIAGRAM - MAIN BOOM

**RT 780-1**

**With Jib, 33 ft offset**

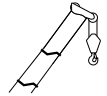

with hook block:  
6 ft 9 in

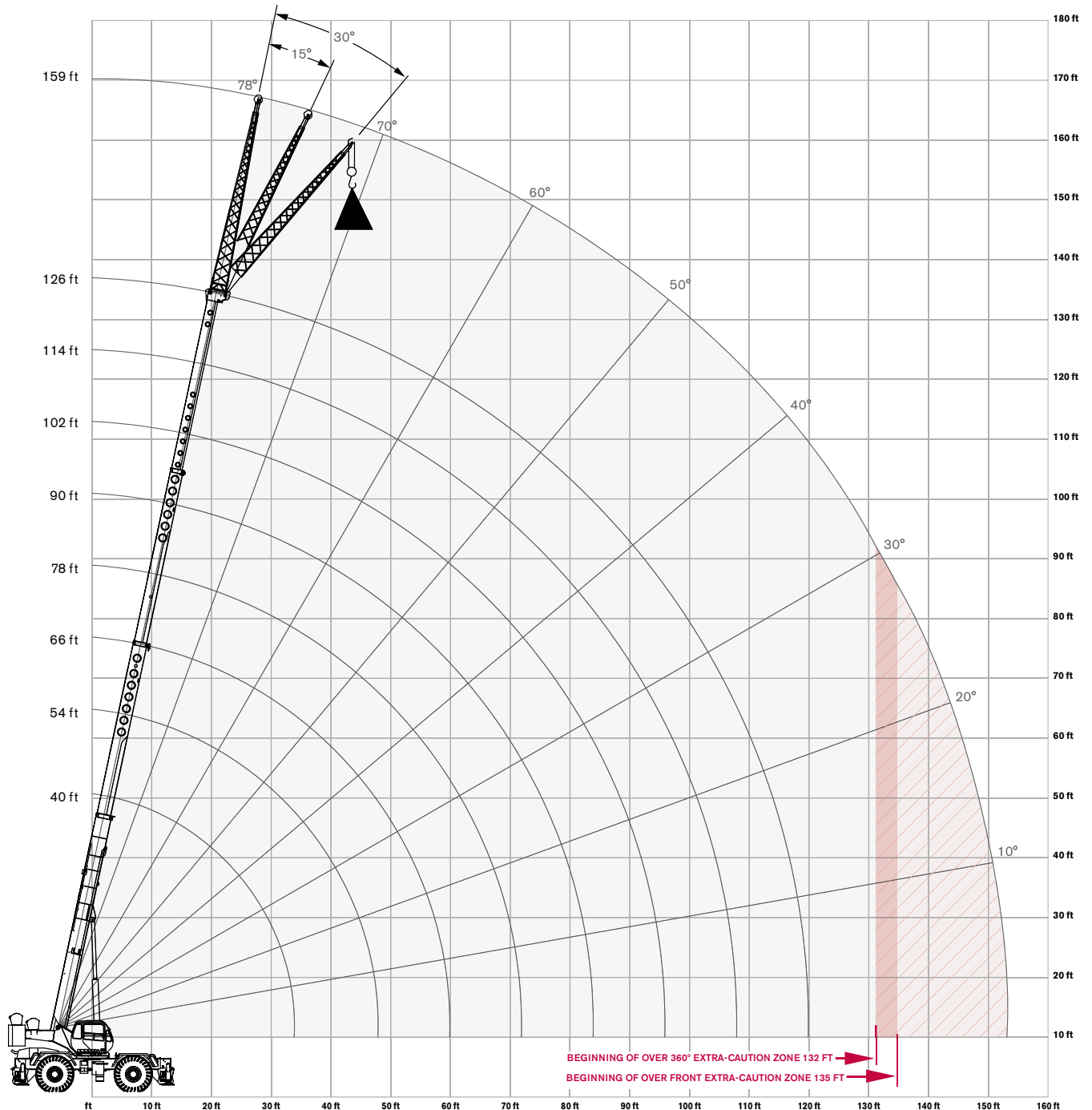



# LOAD CHART- MAIN BOOM

**RT 780-1**

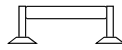

**With Jib, 33 ft offset**

 15,200 lbs counterweight

 Outriggers extended 24 ft (100%)

 360 degree rotation

Standard ASME B30.5

33 ft Offsettable Jib					
0° Offset		15° Offset		30° Offset	
 Radius (ft)	lbs	 Radius (ft)	lbs	 Radius (ft)	lbs
41	12,500	50	8,500	57	6,400
47	12,000	56	8,100	62	6,200
52	11,500	61	7,800	67	6,100
58	10,900	67	7,500	72	5,900
66	9,900	74	7,100	79	5,900
74	9,200	81	6,700	86	5,600
81	8,600	88	6,400	93	5,400
88	7,300	95	6,200	99	5,300
97	5,700	103	5,200	107	5,200
105	4,500	111	4,200	114	4,300
113	3,600	117	3,400	120	3,500
120	2,900	124	2,700	126	2,800
127	2,200	131	2,000	132	1,900
135	1,600	138	1,400	138	1,100

## Notes to lifting capacity

Lifting capacities do not exceed 85% of tipping load. Weight of hook blocks and slings is part of the load, and is to be deducted from the capacity ratings. Consult operation manual for further details.

Note: Data published herein is intended as a guide only and shall not be construed to warrant applicability for lifting purposes. Crane operation is subject to the computer charts and operation manual both supplied with the crane.

# RANGE DIAGRAM - MAIN BOOM

RT 780-1

With Jib, 57 ft offset

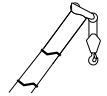

with hook block:  
6 ft 9 in

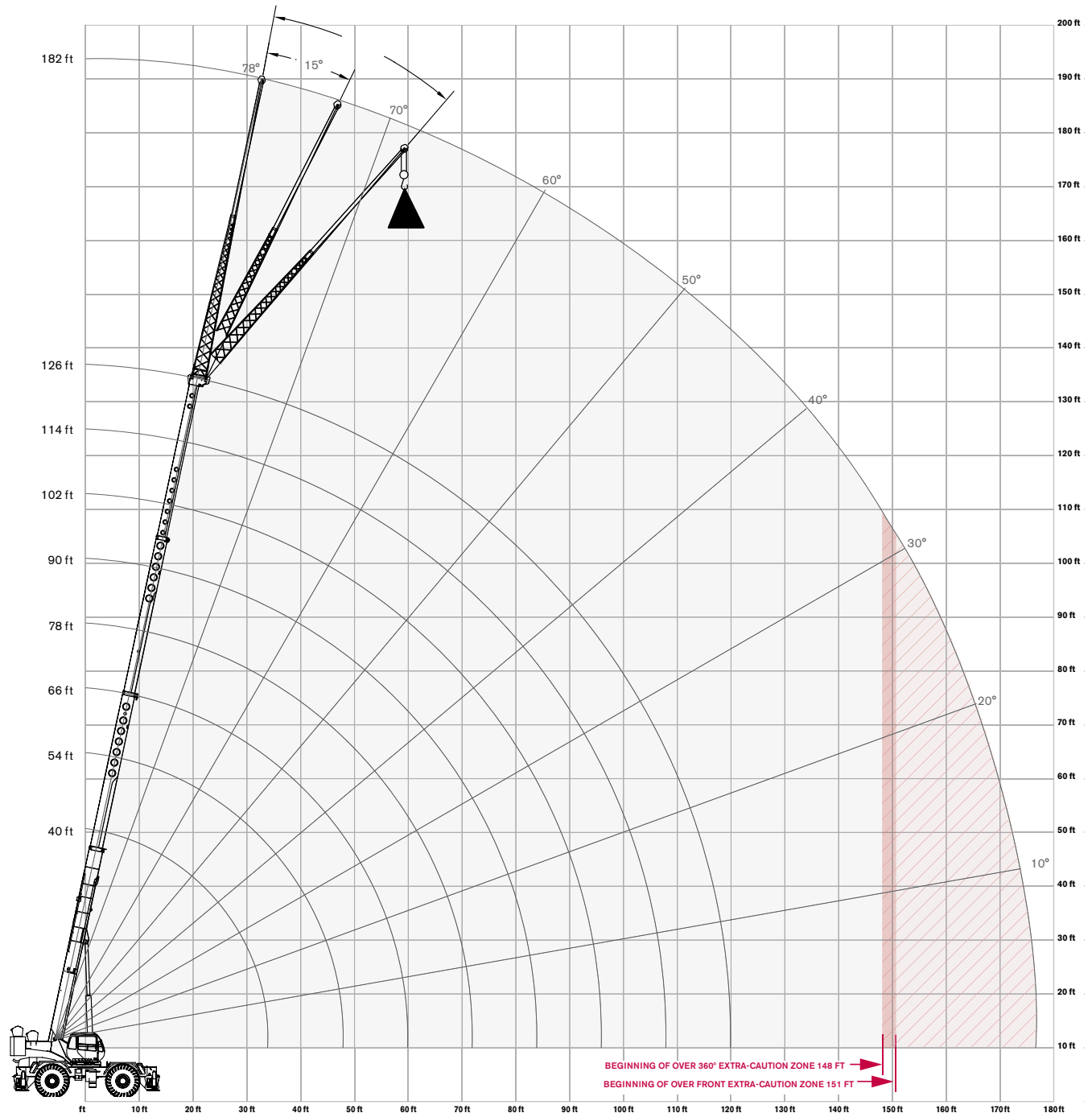



# LOAD CHART- MAIN BOOM

**RT 780-1**

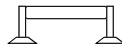

**With Jib, 57 ft offset**

 15,200 lbs counterweight

 Outriggers extended 24 ft (100%)

 360 degree rotation

Standard ASME B30.5

57 ft Offsettable Jib					
0° Offset		15° Offset		30° Offset	
 Radius (ft)	lbs	 Radius (ft)	lbs	 Radius (ft)	lbs
48	6,500	66	4,500	75	3,300
56	6,400	72	4,300	81	3,200
63	6,200	77	4,100	87	3,100
70	6,000	83	3,900	92	3,000
80	5,400	91	3,700	100	2,900
90	4,900	99	3,500	108	2,800
98	4,500	106	3,300	115	2,700
106	4,200	114	3,100	121	2,600
116	3,800	123	2,900	129	2,500
125	3,500	132	2,800	137	2,500
133	2,800	140	2,600	143	2,400
140	2,200	147	2,100	149	2,000
148	1,600	154	1,500	155	1,500
157	1,000	161	1,000	162	1,000

## Notes to lifting capacity

Lifting capacities do not exceed 85% of tipping load. Weight of hook blocks and slings is part of the load, and is to be deducted from the capacity ratings. Consult operation manual for further details.

Note: Data published herein is intended as a guide only and shall not be construed to warrant applicability for lifting purposes. Crane operation is subject to the computer charts and operation manual both supplied with the crane.

# RANGE DIAGRAM - MAIN BOOM

**RT 780-1**

**On Tires**

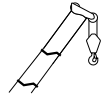

 with hook block:  
6 ft 9 in

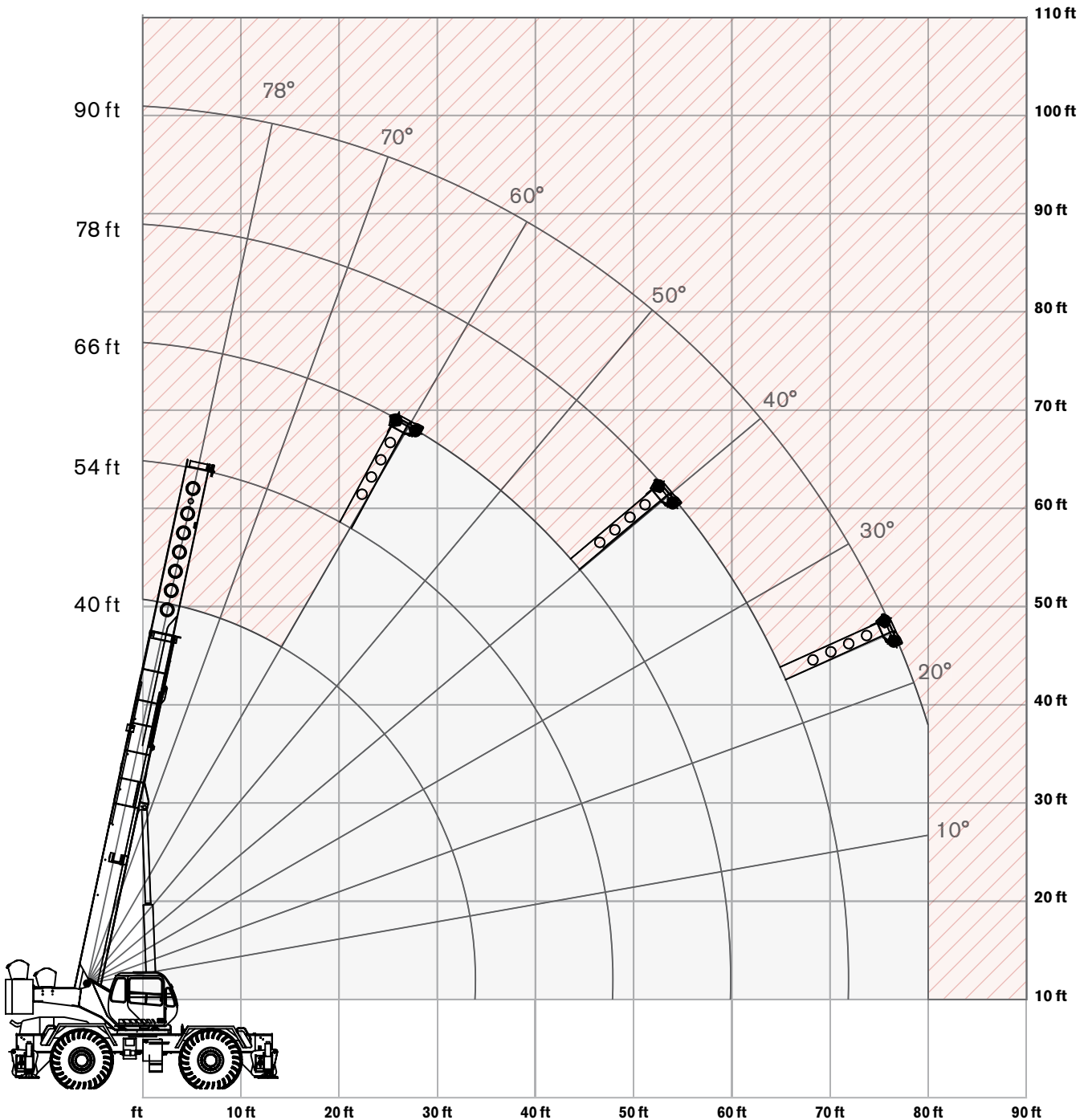



# LOAD CHART- MAIN BOOM

**RT 780-1**

## On Tires

 15,200 lbs counterweight

 360 degree rotation

 On tires  
29.5 X 25-28PR

Standard ASME  
B30.5

Boom		Travel Speed Boom straight over front		
Radius	Length	0 mph	Creep	2.5 mph
ft	ft	lb	lb	lb
10	40	82,700	68,700	51,800
12	40	69,800	60,400	45,300
15	40	54,200	50,700	37,600
20	40	36,000	36,000	28,700
25	54	24,900	24,700	22,500
30	54	18,200	18,200	17,800
35	54	14,200	14,200	14,200
40	66	11,600	11,600	11,100
45	66	9,600	9,600	9,000
50	66	7,900	7,900	7,900
55	78	6,300	6,300	6,300
60	78	4,900	4,900	4,900
65	78	3,300	3,300	3,300
70	90	3,100	3,100	3,100
75	90	2,700	2,700	2,700
80	90	2,200	2,200	2,200

## Notes to lifting capacity





Lifting capacities do not exceed 75% of tipping load. Weight of hook blocks and slings is part of the load, and is to be deducted from the capacity ratings. Consult operation manual for further details.

Note: Data published herein is intended as a guide only and shall not be construed to warrant applicability for lifting purposes. Crane operation is subject to the computer charts and operation manual both supplied with the crane.







# TECHNICAL DESCRIPTION

**RT 780-1**

## Boom







Standard configuration:	
	4 sections hydraulic actuated boom
	Full power mechanically synchronized
	Min. / Max. <span style="float: right;">40 ft / 126 ft</span>
	Boom elevation angle range (min. / max.) <span style="float: right;">-4° / 78°</span>
Optional configuration:	
	Single sheave
	One section, side stowable, with pull out insert Angular offsets <span style="float: right;">33 ft / 57 ft 0, 15 and 30 degrees</span>
	Jib with pull out extended <span style="float: right;">190 ft</span>

## Hoist, Rope and Hook

Standard configuration:	
	Grooved drum Storage capacity <span style="float: right;">561 ft</span>
	Two speed ratios Without load in 5th layer (low range / high range) <span style="float: right;">275 ft/min / 489 ft/min</span> Without load in 1st layer (low range / high range) <span style="float: right;">191 ft/min / 341 ft/min</span>
	6 x 19 IWRC XIPS, right regular lay, preformed
	<span style="float: right;">3/4 in</span>
	<span style="float: right;">600 ft</span>
	Max. line pull; 1st layer low-range <span style="float: right;">18,450 lb</span> Max. line pull permissible <span style="float: right;">13,800 lb</span>





### Optional configuration:

	5 sheaves 5 sheaves	60 USSt 80 USSt
	Grooved drum Storage capacity	591 ft
	Without load in 5th layer (maximum)	489 ft/min
	Rotation resistant compacted strand 34X7	
		3/4 in
		600 ft
	Minimum breaking strength Permissible line pull	69,000 lbs 13,800 lbs

## Superstructure

### Standard configuration:

	Non stop Maximum rotation speed without load	360° 2.2 rpm
	Hydraulic motor Planetary reducer	
	Manually actuated by foot pedal 360° house lock	

## Cab, Controls, Operator aids and Load limiter / Load indicator

### Standard configuration:



Sliding door  
Hinged, tinted all glass skylight  
Six way adjustable seat



Armrest mounted dual axis electro-proportional joysticks  
Steering wheel column with gear selector on the left and directional light selector on the right  
Dashboard mounted switches for outrigger operation



Graphic interface for rated capacity indicator

### Optional configuration:



Hydraulic powered air conditioner  
Hydraulic powered heater  
Work lights  
Rotating beacon

## Carrier, Engine, Drive-line and Hydraulic system

### Standard configuration:



Hydraulic, independent extension:  
Diameter of outrigger pads  
Area of outrigger pads

24 in  
452 in<sup>2</sup>



Cummins QSB6.7 6 cylinders - Tier 4  
Rated power  
Maximum gross torque  
Intake: turbocharger with intercooler  
Fuel type  
Fuel tank capacity

260 hp @ 2,500 rpm  
730 ft·lb @ 1,500 rpm  
Ultra Low Sulfur Diesel  
80 gallons

### Optional configuration:



Cummins QSB6.7 6 cylinders - Tier 3  
Rated power  
Maximum gross torque  
Intake: turbocharger with intercooler  
Fuel type  
Fuel tank capacity

275 hp @ 2500 rpm  
750 ft·lb @ 1,500 rpm  
Diesel  
80 gallons



6 x 6 powershift transmission with torque converter  
 Selectable 4WD (Four-Wheel Drive)  
 Rigid mounted front axle  
 Oscillating rear axle  
 Differential lock on front and rear axles  
 Rear axle oscillation lock - manual or automatic actuation  
 Air-over-hydraulic disc brakes  
 Front axle parking brake  
 Hydraulic oil cooler



Hydraulic power steering  
 Front wheel steering  
 Four wheel steering concentric  
 Four wheel steering crab



Hydraulic Pumps:

**Tandem pumps:**

Boom lift / Telescope

57.8 gal/min @ 4,500 psi

Power steering / Outriggers and swing

42.1 gal/min @ 4,500 psi

**Single pump:**

Main and auxiliary hoist pump

52.7 gal/min @ 4,500 psi

Hydraulic oil reservoir capacity

178 gallons

Hydraulic oil suction filter

250 microns

Hydraulic oil return filter

5 microns

## Vehicle performance

### Standard configuration:

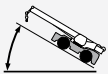

Max. in 1<sup>st</sup> gear

98.9%

Max. in 6<sup>th</sup> gear

3%



Max. (6<sup>th</sup> gear)

25 mph

## Tires

### Standard configuration:



Wide tread - Earth mover pattern

29.5 X 25-28PR

Effective Date: July 2012. Product specifications and prices are subject to change without notice or obligation. The photographs and/or drawings in this document are for illustrative purposes only. Refer to the appropriate Operator's Manual for instructions on the proper use of this equipment. Failure to follow the appropriate Operator's Manual when using our equipment or to otherwise act irresponsibly may result in serious injury or death. The only warranty applicable to our equipment is the standard written warranty applicable to the particular product and sale and Terex makes no other warranty, express or implied. Products and services listed may be trademarks, service marks or trade-names of Terex Corporation and/or its subsidiaries in the USA and other countries. All rights are reserved. Terex® is a registered trademark of Terex Corporation in the USA and many other countries.

Copyright 2012 Terex Corporation.

Terex Cranes, Global Marketing, Dinglerstraße 24, 66482 Zweibrücken, Germany  
Tel. +49 (0) 6332 830, Email: info.cranes@terex.com, www.terexcranes.com



[www.terexcranes.com](http://www.terexcranes.com)

Brochure Reference: TC-DS-I-E-RT780-1-07/12



**WORKS FOR YOU.™**