

TEREX MODEL T 340XL 40 TON CAPACITY

Hydraulic Truck Crane

Transportation Book

Table of Contents

range diagram & lifting capacities

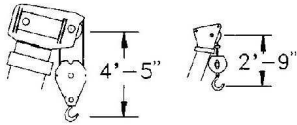

DIMENSIONS ARE FOR LARGEST FACTORY FURNISHED HOOK BLOCK AND HOOK & BALL, WITH ANTI-TWO BLOCK ACTIVATED

Range Diagram (33.75' - 105' boom)

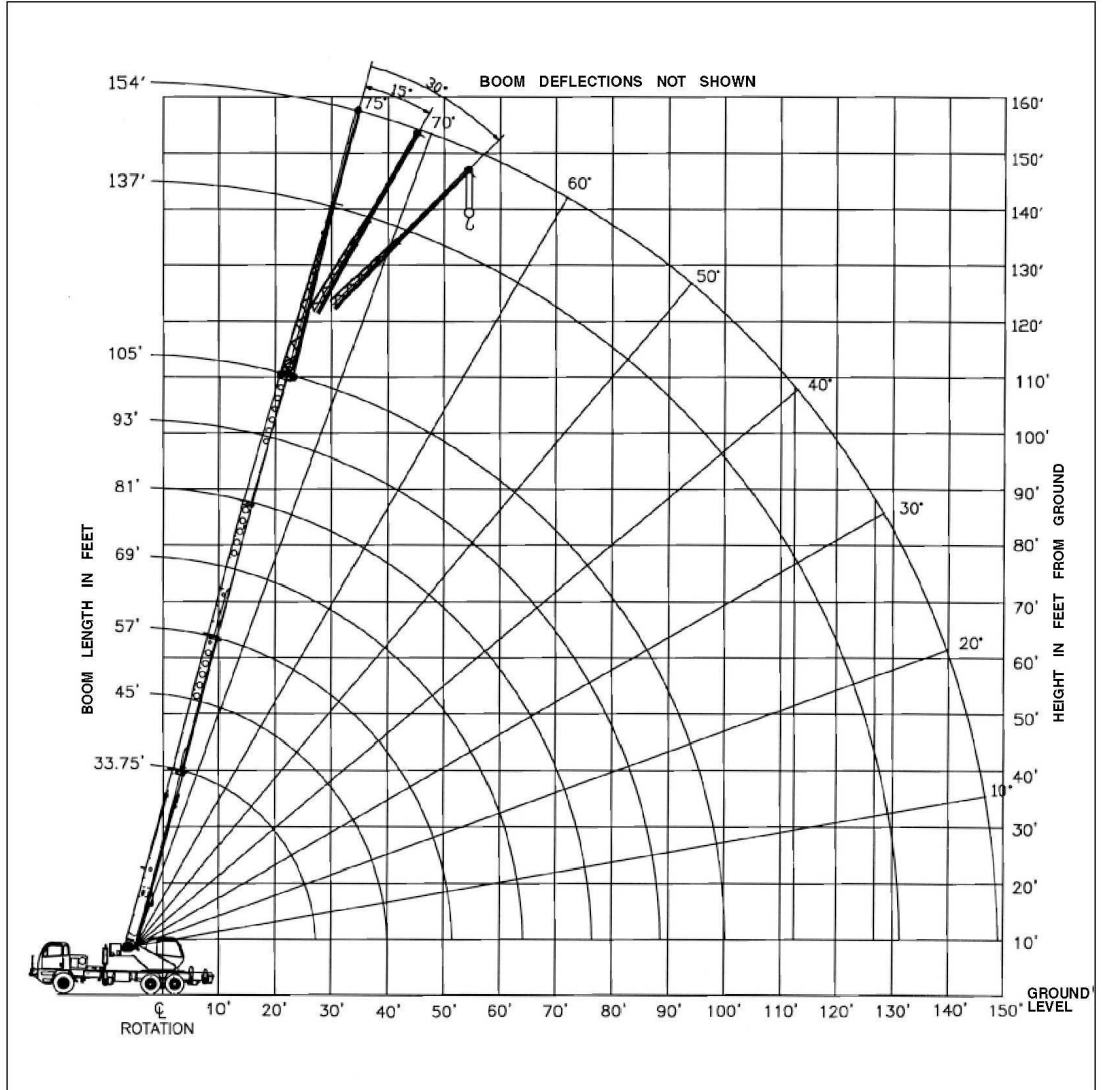

CRANE WORKING CONDITIONS

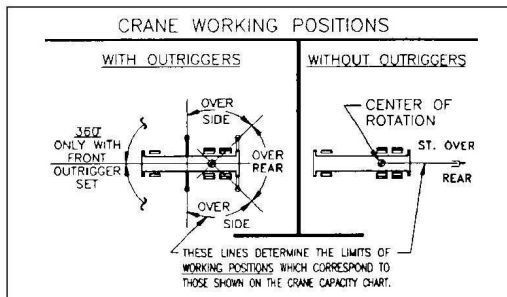

REDUCTION IN MAIN BOOM CAPACITY

All Jibs in Stowed Position	0 Lbs.
Aux. Boom in Head Sheave	100 Lbs.

HOOK BLOCK WEIGHTS

Hook & Ball	239 Lbs.
25T Hook Block (2 Sheave)	682 Lbs.
30T Hook Block (3 Sheave)	670 Lbs.
40T Hook Block (4 Sheave)	690 Lbs.

Lifting Capacities – Pounds (33.75’– 105’ boom)

COUNTERWEIGHT:
F. BUMPER 1350 LBS.
UPPERSTRUCTURE:
W/AUX. WINCH 9900 LBS.
W/O AUX. WINCH 11000 LBS.

BOOM LENGTH 33.75-105 FT.
STABILITY PERCENTAGE
ON OUTRIGGERS 85%
ON TIRES 75%
PCSA CLASS 9-128

CAUTION: Do not use this specification sheet as a load rating chart. The format of data is not consistent with the machine chart and may be subject to change.

ON OUTRIGGERS - FULLY EXTENDED

LOAD RADIUS (FT)	BOOM LENGTH 33.75 FT			BOOM LENGTH 45 FT			BOOM LENGTH 57 FT			LOAD RADIUS (FT)
	LOADED BOOM ANGLE (DEG)	OVER REAR (LB)	360° (LB)	LOADED BOOM ANGLE (DEG)	OVER REAR (LB)	360° (LB)	LOADED BOOM ANGLE (DEG)	OVER REAR (LB)	360° (LB)	
9	67.8	80,000*	80,000*							9
10	66.0	64,500*	64,500*	72.3	46,600*	46,600*				10
12	62.1	58,100*	58,100*	69.6	46,600*	46,600*	74.0	46,600*	46,600*	12
15	56.1	50,800*	50,800*	65.4	46,600*	46,600*	70.8	44,600*	44,600*	15
20	44.8	39,700*	38,500*	58.1	38,900*	38,900*	65.4	36,500*	36,500*	20
25	30.2	30,000*	28,700*	50.1	31,000*	29,700*	59.7	31,100*	30,300*	25
30				40.9	24,600*	22,600*	53.6	25,200*	23,200*	30
35				29.5	19,400*	16,900*	46.9	20,000*	17,400*	35
40				8.4	15,200*	12,800*	39.4	15,900*	13,500*	40
45							30.4	12,900*	10,800*	45
50							17.5	10,600*	8,600*	50
55										55
60										60
65										65
70										70
75										75
80										80
85										85
90										90

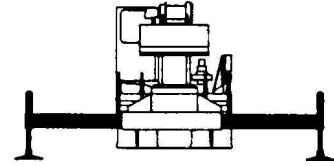

**USE THESE CHARTS ONLY
WHEN ALL OUTRIGGERS
ARE FULLY EXTENDED**

ON OUTRIGGERS - FULLY EXTENDED

LOAD RADIUS (FT)	BOOM LENGTH 69 FT			BOOM LENGTH 81 FT			BOOM LENGTH 93 FT			BOOM LENGTH 105 FT			LOAD RADIUS (FT)
	LOADED BOOM ANGLE (DEG)	OVER REAR (LB)	360° (LB)	LOADED BOOM ANGLE (DEG)	OVER REAR (LB)	360° (LB)	LOADED BOOM ANGLE (DEG)	OVER REAR (LB)	360° (LB)	LOADED BOOM ANGLE (DEG)	OVER REAR (LB)	360° (LB)	
9													9
10													10
12													12
15	74.3	41,700*	41,700*										15
20	69.9	34,900*	34,900*	73.0	30,700*	30,700*							20
25	65.4	29,500*	29,500*	69.2	26,100*	26,100*	72.0	23,500*	23,500*				25
30	60.7	25,500*	23,500*	65.4	22,600*	22,600*	68.7	20,400*	20,400*	71.3	18,700*	18,700*	30
35	55.8	20,300*	17,700*	61.4	19,700*	17,900*	65.4	17,800*	17,800*	68.4	16,300*	16,300*	35
40	50.5	16,200*	13,800*	57.3	16,400*	14,000*	61.9	15,700*	14,200*	65.4	14,500*	14,300*	40
45	44.8	13,300*	11,100*	52.9	13,500*	11,300*	58.3	13,600*	11,400*	62.3	13,000*	11,500*	45
50	38.4	11,000*	9,000*	48.3	11,200*	9,200*	54.6	11,400*	9,300*	59.2	11,500*	9,400*	50
55	31.0	9,200*	7,400*	43.3	9,500*	7,600*	50.7	9,600*	7,700*	55.9	9,700*	7,800*	55
60	21.3	7,700*	6,000*	37.7	8,000*	6,300*	46.6	8,200*	6,400*	52.5	8,300*	6,500*	60
65				31.4	6,800*	5,200*	42.1	7,000*	5,300*	49.0	7,100*	5,400*	65
70				23.5	5,800*	4,300*	37.2	6,000*	4,400*	45.2	6,100*	4,500*	70
75				11.1	4,900*	3,500*	31.7	5,100*	3,700*	41.2	5,200*	3,800*	75
80							25.1	4,300*	3,000*	36.8	4,500*	3,100*	80
85							16.0	3,700*	2,400*	31.9	3,800*	2,600*	85
90										26.2	3,300*	2,100*	90
95										18.9	2,800*	1,600*	95
100										5.2	2,300*	1,200*	100

** MAXIMUM CAPACITY AT 0 DEGREE BOOM ANGLE

BOOM LENGTH 33.75 FT			BOOM LENGTH 45 FT			BOOM LENGTH 57 FT			BOOM LENGTH 69 FT			BOOM LENGTH 81 FT			BOOM LENGTH 93 FT			BOOM LENGTH 105 FT		
LOAD RADIUS (FT)	OVER REAR (LB)	360° (LB)	LOAD RADIUS (FT)	OVER REAR (LB)	360° (LB)	LOAD RADIUS (FT)	OVER REAR (LB)	360° (LB)	LOAD RADIUS (FT)	OVER REAR (LB)	360° (LB)	LOAD RADIUS (FT)	OVER REAR (LB)	360° (LB)	LOAD RADIUS (FT)	OVER REAR (LB)	360° (LB)	LOAD RADIUS (FT)	OVER REAR (LB)	360° (LB)
29.1	24,400*	22,600*	40.3	14,900*	12,500*	52.3	9,600*	7,700*	64.3	6,600*	4,900*	76.3	4,600*	3,200*	88.3	3,200*	2,000*	100.3	2,200*	1,100*

Lifting Capacities – Pounds (33.75’ – 105’ boom)

COUNTERWEIGHT: F. BUMPER 1350 LBS. BOOM LENGTH 33.75-105 FT.
 UPPERSTRUCTURE: W/AUX. WINCH 9900 LBS. STABILITY PERCENTAGE ON OUTRIGGERS 85%
 W/O AUX. WINCH 11000 LBS. ON TIRES 75%
 PCSA CLASS 9-128

CAUTION: Do not use this specification sheet as a load rating chart. The format of data is not consistent with the machine chart and may be subject to change.

ON OUTRIGGERS - MID POSITION

LOAD RADIUS (FT)	BOOM LENGTH 33.75 FT		BOOM LENGTH 45 FT		BOOM LENGTH 57 FT		BOOM LENGTH 69 FT		BOOM LENGTH 81 FT		BOOM LENGTH 93 FT		BOOM LENGTH 105 FT		LOAD RADIUS (FT)
	LOADED BOOM ANGLE (DEG)	360° (LB)	LOADED BOOM ANGLE (DEG)	360° (LB)	LOADED BOOM ANGLE (DEG)	360° (LB)	LOADED BOOM ANGLE (DEG)	360° (LB)	LOADED BOOM ANGLE (DEG)	360° (LB)	LOADED BOOM ANGLE (DEG)	360° (LB)	LOADED BOOM ANGLE (DEG)	360° (LB)	
10	66.0	64,500*	72.3	46,600*											10
12	62.1	58,100*	69.6	46,600*	74.0	46,600*									12
15	56.1	39,200	65.4	40,200	70.8	40,800	74.3	41,200							15
20	44.8	21,800	58.1	22,700	65.4	23,200	69.9	23,500	73.0	23,800					20
25	30.2	13,800	50.1	14,800	59.7	15,300	65.4	15,600	69.2	15,800	72.0	15,900			25
30			40.9	10,300	53.6	10,800	60.7	11,100	65.4	11,300	68.7	11,400	71.3	11,500	30
35			29.5	7,200	46.9	7,900	55.8	8,100	61.4	8,300	65.4	8,500	68.4	8,600	35
40			8.4	5,000	39.4	5,800	50.5	6,100	57.3	6,300	61.9	6,400	65.4	6,500	40
45					30.4	4,200	44.8	4,600	52.9	4,800	58.3	4,900	62.3	5,000	45
50					17.5	3,000	38.4	3,400	48.3	3,600	54.6	3,700	59.2	3,800	50
55							31.0	2,400	43.3	2,700	50.7	2,800	55.9	2,900	55
60							21.3	1,600	37.7	1,900	46.6	2,100	52.5	2,200	60
65									31.4	1,200	42.1	1,400	49.0	1,500	65

** MAXIMUM CAPACITY AT 0 DEGREE BOOM ANGLE

BOOM LENGTH 33.75 FT		BOOM LENGTH 45 FT		BOOM LENGTH 57 FT		BOOM LENGTH 69 FT		BOOM LENGTH 81 FT		BOOM LENGTH 93 FT		BOOM LENGTH 105 FT	
LOAD RADIUS (FT)	360° (LB)	LOAD RADIUS (FT)	360° (LB)	LOAD RADIUS (FT)	360° (LB)	LOAD RADIUS (FT)	360° (LB)	LOAD RADIUS (FT)	360° (LB)	LOAD RADIUS (FT)	360° (LB)	LOAD RADIUS (FT)	360° (LB)
29.1	9,600	40.3	4,900	52.3	2,400	64.3	1,000						

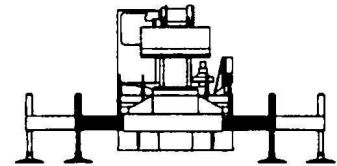

USE THESE CHARTS ONLY WHEN ALL OUTRIGGERS ARE PINNED IN MID POSITION

ON OUTRIGGERS - RETRACTED

LOAD RADIUS (FT)	BOOM LENGTH 33.75 FT		BOOM LENGTH 45 FT		BOOM LENGTH 57 FT		BOOM LENGTH 69 FT		BOOM LENGTH 81 FT		BOOM LENGTH 93 FT		BOOM LENGTH 105 FT		LOAD RADIUS (FT)
	LOADED BOOM ANGLE (DEG)	360° (LB)	LOADED BOOM ANGLE (DEG)	360° (LB)	LOADED BOOM ANGLE (DEG)	360° (LB)	LOADED BOOM ANGLE (DEG)	360° (LB)	LOADED BOOM ANGLE (DEG)	360° (LB)	LOADED BOOM ANGLE (DEG)	360° (LB)	LOADED BOOM ANGLE (DEG)	360° (LB)	
10	66.0	36,500	72.3	37,400											10
12	62.1	26,100	69.6	26,900	74.0	27,400									12
15	56.1	17,300	65.4	18,200	70.8	18,600	74.3	18,900							15
20	44.8	9,700	58.1	10,700	65.4	11,100	69.9	11,400	73.0	11,500					20
25	30.2	5,600	50.1	6,600	59.7	7,100	65.4	7,400	69.2	7,500	72.0	7,700			25
30			40.9	4,000	53.6	4,600	60.7	4,900	65.4	5,000	68.7	5,200	71.3	5,300	30
35			29.5	2,200	46.9	2,800	55.8	3,100	61.4	3,300	65.4	3,500	68.4	3,600	35
40			8.4	800	39.4	1,500	50.5	1,900	57.3	2,100	61.9	2,200	65.4	2,300	40
45									52.9	1,100	58.3	1,300	62.3	1,400	45

** MAXIMUM CAPACITY AT 0 DEGREE BOOM ANGLE

BOOM LENGTH 33.75 FT		BOOM LENGTH 45 FT		BOOM LENGTH 57 FT		BOOM LENGTH 69 FT		BOOM LENGTH 81 FT		BOOM LENGTH 93 FT		BOOM LENGTH 105 FT	
LOAD RADIUS (FT)	360° (LB)	LOAD RADIUS (FT)	360° (LB)	LOAD RADIUS (FT)	360° (LB)	LOAD RADIUS (FT)	360° (LB)	LOAD RADIUS (FT)	360° (LB)	LOAD RADIUS (FT)	360° (LB)	LOAD RADIUS (FT)	360° (LB)
29.1	3,200												

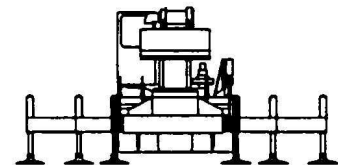

USE THESE CHARTS WHEN ALL OUTRIGGER BEAMS ARE NOT IN EITHER THE MID OR FULLY EXTENDED POSITION

Lifting Capacities – Pounds (33.75’– 105’ boom)

COUNTERWEIGHT:
F. BUMPER 1350 LBS.
UPPERSTRUCTURE:
W/AUX. WINCH 9900 LBS.
W/O AUX. WINCH 11000 LBS.

BOOM LENGTH 30-94 FT.
STABILITY PERCENTAGE
ON OUTRIGGERS 85%
ON TIRES 75%
PCSA CLASS 9-128

CAUTION: Do not use this specification sheet as a load rating chart. The format of data is not consistent with the machine chart and may be subject to change.

SIDE STOW JIB ON FULLY EXTENDED OUTRIGGERS

LOADED BOOM ANGLE (DEG)	32 FT OFFSETTABLE JIB									49 FT OFFSETTABLE JIB									LOADED BOOM ANGLE (DEG)
	0° OFFSET			15° OFFSET			30° OFFSET			0° OFFSET			15° OFFSET			30° OFFSET			
	LOAD RADIUS (REF) (FT)	REAR ONLY (LB)	360° (LB)	LOAD RADIUS (REF) (FT)	REAR ONLY (LB)	360° (LB)	LOAD RADIUS (REF) (FT)	REAR ONLY (LB)	360° (LB)	LOAD RADIUS (REF) (FT)	REAR ONLY (LB)	360° (LB)	LOAD RADIUS (REF) (FT)	REAR ONLY (LB)	360° (LB)	LOAD RADIUS (REF) (FT)	REAR ONLY (LB)	360° (LB)	
75	43	9,300*	9,300*	51	8,500*	8,500*	57	6,600*	6,600*	47	5,100*	5,100*	57	3,400*	3,400*	66	2,700*	2,700*	75
73	47	8,900*	8,900*	55	8,200*	8,200*	61	6,400*	6,400*	52	4,800*	4,800*	63	3,300*	3,300*	71	2,700*	2,700*	73
71	51	8,500*	8,500*	59	7,800*	7,800*	65	6,300*	6,300*	58	4,500*	4,500*	69	3,200*	3,200*	76	2,600*	2,600*	71
68	56	7,900*	7,700*	64	7,400*	6,400*	70	6,000*	6,000*	65	4,100*	4,100*	76	3,000*	3,000*	82	2,500*	2,500*	68
65	62	7,300*	6,200*	69	6,800*	5,300*	75	5,900*	5,100*	72	3,800*	3,800*	83	2,900*	2,900*	89	2,500*	2,500*	65
62	68	6,400*	5,100*	75	5,700*	4,500*	80	5,600*	4,300*	79	3,600*	3,600*	89	2,800*	2,800*	95	2,400*	2,400*	62
59	74	5,300*	4,200*	81	4,900*	3,900*	85	4,900*	3,500*	86	3,400*	3,400*	95	2,700*	2,700*	101	2,400*	2,400*	59
55	80	4,400*	3,200*	87	4,200*	3,000*	91	4,100*	2,900*	93	3,100*	2,700*	102	2,600*	2,500*	107	2,300*	2,300*	55
51	87	3,700*	2,500*	93	3,500*	2,300*	97	3,500*	2,300*	101	2,900*	2,100*	108	2,500*	2,000*	113	2,300*	1,800*	51
47	94	3,100*	2,000*	99	2,900*	1,900*	102	2,900*	1,800*	108	2,500*	1,600*	114	2,300*	1,500*	119	2,200*	1,300*	47
43	101	2,500*	1,500*	105	2,400*	1,500*	107	2,300*	1,400*	115	2,000*	1,200*	120	1,900*	1,100*	125	1,800*	1,000*	43
38	108	1,900*	1,000*	112	1,800*	1,000*	113	1,800*	900*	122	1,600*	800*	127	1,500*		131	1,400*		38
32	115	1,400*		119	1,400*		120	1,400*		130	1,200*		134	1,100*		136	1,100*		32
25	122	1,000*		125	1,000*					139	800*		141	800*					25

NOTES FOR JIB CAPACITIES

- A. For all boom lengths less than the maximum with a jib erected, the rated loads are determined by boom angle only in the appropriate column.
- B. For boom angle not shown, use the capacity of the next lower boom angle.
- C. Listed radii are for extended main boom only.

ON TIRES

RADIUS (FT)	MAX BOOM LENGTH (FT)	ALL		
		PICK & CARRY		2.5 MPH
		STATIONARY	CREEP	
STRAIGHT OVER REAR				
10	33.75	21,700	21,700	16,500*
12	33.75	15,600	15,600	14,900*
15	45	12,800	12,800	12,700*
20	45	8,500	8,500	8,500
25	45	5,800	5,800	5,800
30	45	3,800	3,800	3,800
35	57	2,500	2,500	2,500
40	57	1,700	1,700	1,700
45	57	1,000	1,000	1,000

NOTES FOR ON TIRE CAPACITIES

- A. For Pick and Carry operations, boom must be centered over the rear of the crane with swing brake and lock engaged. Use minimum boom point height and keep load close to ground surface. Travel must be on smooth level surface.
- B. The load should be restrained from swinging. **NO ON TIRE OPERATION WITH JIB ERECTED.**
- C. Without outriggers, never maneuver the boom beyond listed load radii for applicable tires to ensure stability.
- D. Creep speed is crane movement of less than 200 Ft. (61m) in a 30 minute period and not exceeding 1.0 mph(1.6 km/h).
- E. Refer to General Notes for additional information.

MAXIMUM PERMISSIBLE HOIST LINE LOAD

LINE PARTS	1	2	3	4	5	6	7	8	9	10
MAX. LOAD	9,080	18,160	27,240	36,320	45,400	54,480	63,560	72,640	81,720	90,800
BOOM HEAD	2	3-D	2-3	1-4-D	2-3-4	2-3-4-D	1-2-3-4	1-2-3-4-D	1-2-3-4-5	1-2-3-4-5-D
HOOK BLOCK	D	3	3-D	1-4	2-3-D	2-3-4	2-3-4-D	1-2-3-4	1-2-3-4-D	1-2-3-4-5
WIRE ROPE: 5/8" ROTATION RESISTANT COMPACTED STRAND, 18X19 OR 19X19 MINIMUM BREAKING STRENGTH - 22.7 TONS 5/8" 6X19 OR 6X37 IWRC IPS PREFORMED RIGHT REGULAR LAY MINIMUM BREAKING STRENGTH - 17.9 TONS										

GENERAL NOTES

GENERAL

1. Rated loads as shown on Lift Charts pertain to this machine as originally manufactured and equipped. Modifications to the machine or use of optional equipment other than that specified can result in a reduction of capacity.
2. Construction equipment can be hazardous if improperly operated or maintained. Operation and maintenance of this machine shall be in compliance with the information in the Operator's, Parts and Safety Manuals supplied with this machine. If these manuals are missing, order replacements from the manufacturer through your distributor.
3. These warnings do not constitute all of the operating conditions for the crane. The operator and job site supervision must read the OPERATORS MANUAL, CIMA SAFETY MANUAL, APPLICABLE OSHA REGULATIONS, AND SOCIETY OF MECHANICAL ENGINEERS (ASME) SAFETY STANDARDS FOR CRANES.
4. This crane and its load ratings are in accordance with POWER CRANE & SHOVEL ASSOCIATION, STANDARD NO. 4, SAE CRANE LOAD STABILITY TEST CODE J765A, SAE METHOD OF TEST FOR CRANE STRUCTURE J1063 AND APPLICABLE SAFETY CODE FOR CRANES, DERRICKS AND HOISTS, ASME/ANSI B30.5.

DEFINITIONS

1. **LOAD RADIUS** – The horizontal distance from the axis of rotation before loading to the center of the vertical hoist line or tackle with a load applied.
2. **LOADED BOOM ANGLE** – It is the angle between the boom base section and the horizontal, after lifting the rated load at the rated radius. The boom angle before loading should be greater to account for deflections. The loaded boom angle combined with boom length give only an approximation of the operating radius.
3. **WORKING AREA** – Areas measured in a circular arc about the centerline of rotation as shown in the diagram.
4. **FREELY SUSPENDED LOAD** – Load hanging free with no direct external force applied except by the hoist rope.
5. **SIDE LOAD** – Horizontal force applied to the lifted load either on the ground or in the air.
6. **NO LOAD STABILITY LIMIT** – The stability limit radius shown on the range diagrams is the radius beyond which it is not permitted to position the boom, when the boom angle is less than the minimum shown on the applicable load chart, because the machine can overturn without any load.
7. **BOOM SIDE OF CRANE** – The side of the crane over which the boom is positioned when in an OVER SIDE working position.

SET-UP

1. Crane load ratings are based on the crane being leveled and standing on a firm, uniform supporting surface.
2. Crane load ratings on outriggers are based on all outrigger beams being fully extended or in the case of partial extension ratings mechanically pinned in the appropriate position, and the tires free of the supporting surface.
3. Crane load ratings on tires depend on appropriate inflation pressure and the tire conditions. Caution must be exercised when increasing air pressures in tires. Consult Operator's Manual for precautions.
4. Use of jibs, lattice-type boom extensions, or fourth section pullouts extended is not permitted for pick and carry operations.
5. Consult appropriate section of the Operator's and Service Manual for more exact description of hoist line reeving.
6. The use of more parts of line than required by the load may result in having insufficient rope to allow the hook block to reach the ground.
7. Properly maintained wire rope is essential for safe crane operation. Consult Operator's Manual for proper maintenance and inspection requirements.
8. When spin-resistant wire rope is used, the allowable rope loading shall be the breaking strength divided by five (5), unless otherwise specified by the wire rope manufacturer.
9. Do not elevate the boom above 60° unless the boom is positioned in-line with the crane's chassis or the outriggers are extended. Failure to observe this warning may result in loss of stability.

OPERATION

1. **CRANE LOAD RATINGS MUST NOT BE EXCEEDED. DO NOT ATTEMPT TO TIP THE CRANE TO DETERMINE ALLOWABLE LOADS.**
 2. When either radius or boom length, or both, are between listed values, the smaller of the two listed load ratings shall be used.
 3. Do not operate at longer radii than those listed on the applicable load rating chart (cross hatched areas shown on range diagrams).
 4. The boom angles shown on the Capacity Chart give an approximation of the operating radius for a specified boom length. The boom angle, before loading, should be greater to account for boom deflection. It may be necessary to retract the boom if maximum boom angle is insufficient to maintain rated radius.
 5. Power telescoping boom sections must be extended equally.
 6. Rated loads include the weight of hook block, slings, and auxiliary lifting devices. Their weights shall be subtracted from the listed rated load to obtain the net load that can be lifted.
When lifting over the jib the weight of any hook block, slings, and auxiliary lifting devices at the boom head must be added to the load.
When jibs are erected but unused add two (2) times the weight of any hook block, slings, and auxiliary lifting devices at the jib head to the load.
 7. Rated loads do not exceed 85% on outriggers or 75% on tires, of the tipping load as determined by SAE Crane Stability Test Code J765a. Structural strength ratings in chart are indicated with an asterisk (*).
 8. Rated loads are based on freely suspended loads. No attempt shall be made to drag a load horizontally on the ground in any direction.
 9. The user shall operate at reduced ratings to allow for adverse job conditions, such as: Soft or uneven ground, out of level conditions, high winds, side loads, pendulum action, jerking or sudden stopping of loads, hazardous conditions, experience of personnel, two machine lifts, traveling with loads, electric wires, etc., (side pull on boom or jib is hazardous). Derating of the cranes lifting capacity is required when wind speed exceeds 20 MPH. the center of the lifted load must never be allowed to move more than 3* feet off the center line of the base boom section due to the effects of wind, inertia, or any combination of the two.
**Use 2 feet off the center line of the base boom for a two section boom, 3 feet for a three section boom, or 4 feet for a four section boom.
 10. The maximum load which can be telescoped is not definable, because of variations in loadings and crane maintenance, but it is permissible to attempt retraction and extension if load ratings are not exceeded.
 11. Load ratings are dependent upon the crane being maintained according to manufacturer's specifications.
 12. It is recommended that load handling devices, including hooks, and hook blocks, be kept away from boom head at all times.
 13. **FOR TRUCK CRANES ONLY:** 360° capacities apply only to machines equipped with a front outrigger jack and all five (5) outrigger jacks properly set. If the front (5th) outrigger jack is not properly set, the work area is restricted to the over side and over rear areas as shown on the Crane Working Positions diagram. Use the 360° load ratings in the overside work areas.
 14. Do not lift with outrigger beams positioned between the fully extended and intermediate (pinned) positions.
 15. Truck Cranes not equipped with equalizing (bogie) beams between the rear axles may not be used for lifting "on tires". Truck Cranes equipped with equalizing beams and rear air suspension should "dump" the air before lifting "on tires".
- ## CLAMSHELL, MAGNET, AND CONCRETE BUCKET SERVICE
1. Maximum boom length for clamshell and magnet service is 50 feet.
 2. Weight of clamshell or magnet, plus contents are not to exceed 6,000 pounds or 90% of rated lifting capacities, whichever is less. For concrete bucket operation, weight of bucket and load must not exceed 90% of rated lifting capacity.

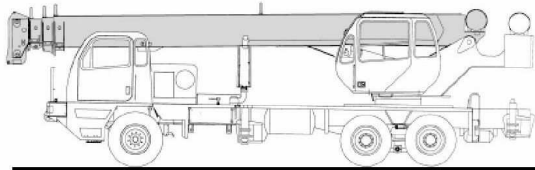

STANDARD BOOM EQUIPMENT

BOOM

30-94 ft. (9.23-28.49 m), four section full power, mechanically synchronized boom. High-strength four plate construction with embossed side plate holes to reduce weight and increase strength. Anti-friction slide pads. A single boom hoist cylinder provides for boom elevation of -4 to 77 degrees. Maximum tip height is 99 ft. (30.17 m).

BOOM HEAD

Welded to outer section of boom. Four or five non-metallic load sheaves and two metallic idler sheaves mounted on heavy duty, anti-friction bearings. Quick reeving boom head. Provisions made for side-stow jib mounting.

OPTIONAL BOOM EQUIPMENT

MAIN BOOM

33-81 ft. (10.15 - 24.83 m), three section full power, mechanically synchronized boom. High-strength four plate construction with embossed side plate holes to reduce weight and increase strength. Anti-friction slide pads. A single boom hoist cylinder provides for boom elevation of -4 to 77 degrees. Maximum tip height is 87 ft. (26.52 m).

33.75-105' (10.29-32.0 m), four section full power, mechanically synchronized boom. Extra high-strength four plate construction with embossed side plate holes. Anti-friction slide pads. A single boom hoist cylinder provides boom elevation of -4 to 77 degrees. Maximum tip height is 110 ft. (33.5 m).

JIBS

32 ft. (9.68 m) side stow swing-on one-piece lattice type jib. Single sheave mounted on anti-friction bearing. Jib is offsettable at 0°, 15°, or 30°. Maximum tip height is 129 ft. (39.32 m) with 94 ft. (28.49 m) boom, 140 ft. with 105 ft. (32.0 m) boom.

32-49 ft. (9.68 -14.86 m) side-stow swing-on lattice type jib. Single sheave mounted on anti-friction bearing. Jib is extendible to 49 ft. (14.86 m) by means of a 17 ft. (5.18 m) manual pull-out tip section, roller supported for ease of extension. Jib is offsettable at 0°, 15°, or 30°. Maximum tip height is 147 ft. (44.81 m) with 94 ft. (28.49 m) boom, 158 ft. with 105 ft. (32.0 m) boom.

AUXILIARY BOOM HEAD

Removable auxiliary boom head has single sheave mounted on anti-friction bearing. Removable pin-type rope guard for quick reeving. Installs on main boom peak only. Removal is not required for jib use.

HOOK BLOCK

Three, or four metallic sheaves on anti-friction bearings with hook and heavy duty hook latch. Quick reeving design does not require removal of wedge and socket from rope.

HOOK & BALL

7 ton (6.3 mt) top swivel ball with hook and hook latch.

STANDARD UPPERSTRUCTURE EQUIPMENT

UPPERSTRUCTURE FRAME

All welded one-piece structure fabricated with high tensile strength alloy steel. Counterweight is bolted to frame.

TURNTABLE CONNECTION

Swing bearing is a single row, ball type, with external teeth. The swing bearing is bolted to the revolving upperstructure and to the carrier frame.

SWING

A hydraulic motor drives a double planetary reduction gear for precise and smooth swing function. Swing speed (no load) is 2.8 rpm.

SWING BRAKE

Heavy duty multiple disc swing brake is mechanically actuated from operator's cab by foot pedal. Brake may be locked on or used as a momentary brake.

RATED CAPACITY INDICATOR

Rated Capacity Indicator with visual and audible warning system and automatic function disconnects. Second generation pictographic display includes: boom radius, boom angle, boom length, allowable load, actual load, and percentage of allowable load registered by bar graph. Operator settable alarms provided for swing angle, boom length, boom angle, tip height and work area exclusion zone. Anti-two block system includes audio/visual warning and automatic function disconnects.

OPERATOR'S CAB

Environmental cab with all steel construction, optimum visibility, tinted safety glass throughout, and rubber floor matting is mounted on vibration absorbing pads. The cab has a sliding door on the left side, framed sliding window on the right side, hinged tinted all glass skylight and removable front windshield to provide optimum visibility of the load open or closed. Acoustical foam padding insulates against sound and weather. The deluxe six-way adjustable operator's seat is equipped with a mechanical suspension and includes head and arm rests.

STANDARD CARRIER EQUIPMENT

CARRIER CHASSIS

Chassis is Terex designed and built with a 6 x 4 drive. Triple box construction frame is fabricated from high strength alloy steel and provides superior frame rigidity. Full aluminum decking improves access and reduces weight. Aluminum engine housing with sliding cover optimizes engine access while reducing weight and improving corrosion resistance.

AXLES AND SUSPENSION

Rear Axle – 45,000 lb. (20 412 kg) capacity tandem axles with heat treated housings have interaxle differential with lockout. Axles are mounted on standard air suspension, over equalizer beams with shock absorbers to distribute weight evenly. Front Axle – 22,000 lb. (9979 kg) I beam type axle with air suspension and shock absorbers for exceptional ride.

TIRES

Front: Two 425/65R22.5-20 P.R. All-Position type tubeless.
Rear: Eight 11R22.5-16 P.R. transport type.

BRAKES

Full air brakes on all wheels with ABS split circuit system.

Front brakes: 16.5 x 6 in. (419 x 152 mm)

Rear brakes: 16.5 x 7 in. (419 x 178 mm).

All brakes are air operated "S" cam type with automatic slack adjusters. Lining areas are 384 in² (2477 cm²) front and 920 in² (5935 cm²) rear. Air compressor has standard air dryer. Rear tandem axles have spring-set, air-released parking or emergency brake chambers. Parking brake is applied with

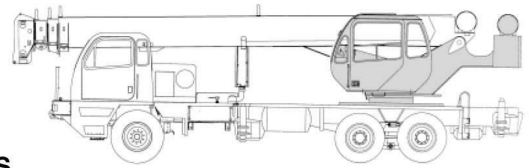

CONTROLS

Armrest mounted dual axis controls for winch(s), swing, and boom elevation. Winch rotation indication incorporated into control handles. Armrest swings up to improve access and egress. Vernier adjustable hand throttle included. Switches include ignition, engine stop, lights, horn, windshield wipers, defroster, outriggers, 360° house lock, etc. Horn and winch speed shift switches are mounted in the levers. Foot control pedals include swing brake, boom telescope, and throttle.

INSTRUMENTATION AND ACCESSORIES

In-cab gauges include bubble level, engine oil pressure, fuel, engine temperature, voltmeter. Indicators include high coolant temperature/low engine oil pressure audio visual warning, low coolant level audio visual warning, and Rated Capacity Indicator. Accessories include fire extinguisher, windshield washer/wiper, skylight wiper, left & right hand rear view mirrors, dash and dome lights, and seat belt. Circuit breakers protect electrical circuits.

HYDRAULIC CONTROL VALVES

Valves are mounted on the rear of the upperstructure and are easily accessible. Valves utilize electric over hydraulic operators and include one pressure compensated load sensing two spool valve for boom elevation and telescope, one pressure compensated load sensing two spool valve for main and auxiliary winch, and one single spool valve for swing. System provides for simultaneous operation of all crane functions. High pressure regeneration feature provides 2-speed boom extension. Quick disconnects are provided for ease of installation of pressure check gauges.

OPTIONAL EQUIPMENT

Auxiliary Winch • LP Heater/Defroster • Hydraulically Powered Air Conditioner • Diesel Heater/Defroster • Tachometer • Work Lights • Heavy Counterweight Package(s)

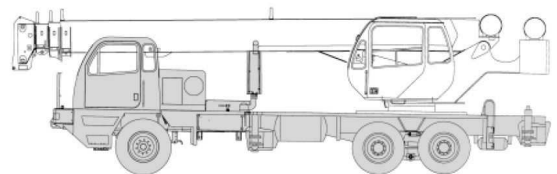

valve mounted on dash panel. Emergency brakes apply automatically when air pressure drops below 60 psi (4.2 kg/cm²).

STEERING

Mechanism includes rack and pinion with integral hydraulic power.

	To \odot of tires	To corner of carrier
Turning radius:	34' 0" (10.35 m)	37'-7" (11.46 m)

TRANSMISSION

Standard: Fuller RT 8908LL transmission has 10 speeds forward and 3 reverse, with neutral safety start. Gear selection is accomplished by single level shift control and two position air shift range selector. Optional: Allison 3500RDS provides 6 speeds forward with lock-up in top 5 gears. Adaptive feed back controls continually optimize shifts for weight, terrain, etc.

MULTI-POSITION OUT & DOWN OUTRIGGERS

Fully independent hydraulic outriggers may be utilized fully extended to 20 ft. (6.10 m), in their 1/2 extended position, or fully retracted. Removable aluminum outrigger pads are 452 in² (2919 cm²) and stow on the carrier frame. Complete controls and sight leveling bubble are located in the operator's cab. Includes 5th, front, outrigger.

STANDARD CARRIER EQUIPMENT (continued)

CARRIER CAB

One-man aluminum cab is mounted on vibration absorbing pads and has optimum visibility, safety glass, acoustical foam padding inside cab for insulating against sound and weather, hot air defroster, six-way adjustable air suspension seat with seat belt and arm rests, and a lockable door with roll down window.

CONTROLS

Included are transmission shift, inter-axle differential lock, cruise control, parking brake, two-speed windshield wiper/washer, heater and defroster, lights, headlight dimmer, dome light, and ignition switch.

INSTRUMENTS

Included are speedometer, hourmeter, tachometer, voltmeter, fuel gauge, engine oil pressure gauge, water temperature gauge, dual air pressure gauges. Warning lights include low coolant level, parking brakes on, low air, pumps engaged, and high beam lights.

ACCESSORIES

Included are fire extinguisher, right hand and left hand rear view mirrors, electric horn, access steps and grab handles (located at four separate points around the crane), back-up alarm, two position boom rack, front and rear towing loops.

LIGHTS

Light package includes headlights with foot operated dimmer switch, clearance lights, tail lights, directional signal lights, four-way hazard flasher lights, back-up lights with audible alarm.

OPTIONAL EQUIPMENT

Spare Tire with Wheel • Immersion Heater(s) • Pintle Hook • Cold Weather Kit • Allison 3500 RDS 6-speed Automatic Transmission • Rear Air Suspension • Engine Exhaust Brake • Air Conditioner • Aluminum R/L Hand Tool Boxes • Ground Level Outrigger Controls

HYDRAULIC SYSTEM

HYDRAULIC PUMPS

Triple pump driven from engine flywheel housing PTO with air shifted mechanical pump disconnect at 1.15 times engine speed. A separate steering pump is driven directly from the engine. Combined system capacity is 115 gpm (435 lpm). Hydraulic oil cooler is standard.

Main Winch Pump

54 gpm (204.4 lpm) @ 3,500 psi (246.1 kg/cm²)

Boom Hoist and Telescope Pump

39 gpm (147.6 lpm) @ 3,500 psi (246.1 kg/cm²)

Outrigger and Swing Pump

22 gpm (83.3 lpm) @ 2,500 psi (175 kg/cm²)

Power Steering Pump

8 gpm (30.3 lpm) @ 2000 psi (105.5 kg/cm²)

FILTRATION

Full flow oil filtration system with bypass protection includes a removable 60 mesh (250 micron) suction screen-type filter and 5 micron replaceable return line filter.

HYDRAULIC RESERVOIR

All welded construction with internal baffles and diffuser. Provides easy access to filters and is equipped with an external sight level gauge. The hydraulic tank is pressurized to aid in keeping out contaminants and in reducing potential pump cavitation. Capacity is 91 gal (344 liters).

MAIN WINCH SPECIFICATIONS

Hydraulic winch with bent axis piston motor and planetary reduction gearing provides 2-speed operation with equal speeds for power up and down. Winch is equipped with an integral automatic brake, grooved drum, tapered flanges, standard cable roller on drum, and electronic rotation indicator.

PERFORMANCE

Max. line speed (no load)

	LO-RANGE	HI-RANGE
First layer	167 fpm (50.9 m/min)	335 fpm (102.1 m/min)
Fifth layer	242 fpm (73.8 m/min)	484 fpm (147.5 m/min)

Max. line pull-first layer 15,639 lbs (7093 kg) 7,298 lbs (3310 kg)

Max. line pull-fifth layer 10,827 lbs (4911 kg) 5,052 lbs (2291 kg)

Permissible line pull 9,000 lbs (4082 kg)

DRUM DIMENSIONS

10.62 in (270 mm) drum diameter
17.55 in (446 mm) length
18.0 in (457 mm) flange dia.
Cable: 5/8" x 450 ft. (16 mm x 137.2 m)
Cable type: 5/8" (16 mm) 6x19 IWRC IPS right regular lay, preformed. Min. breaking strength 17.9 tons (16.2 mt).

DRUM CAPACITY

Max. Storage: 570 ft (173.7 m)
6th layer not a working layer
Max. Usable: 455 ft. (138.7 m)*
*Based on minimum flange height above top layer to comply with ANSI B30.5

OPTIONAL AUX. WINCH

Hydraulic 2-speed winch with bent axis piston motor, equal speed power up and down, planetary reduction with integral automatic brake, grooved drum with tapered flanges, drum roller, and rotation indicator.

PERFORMANCE

Max. line speed (no load)

Fifth layer 484 fpm (147.5 m/min)

Max. line pull

First layer 15,639 lbs (7093 kg)

DRUM DIMENSIONS AND CAPACITY

(Same as main winch)

OPTIONAL HOIST LINE

MAIN WINCH AND OPTIONAL AUXILIARY WINCH – 5/8" (16 mm) rotation resistant compacted strand 18 x 19 or 19 x 19. Min breaking strength 22.6 tons (20.6 mt).

ENGINE SPECIFICATIONS

Make and Model	Cummins ISC 300 (300 hp)
Type	6 cylinder
Bore and Stroke	4.49 x 5.32 in. (114 x 135 mm)
Displacement	504.5 cu. in. (8.27 l)
Max. Gross Horsepower	300 hp (224 kw) @ 2000 rpm
Max. Gross Torque	860 lbs•ft. (1166 N•m)/1300 rpm
Net Horsepower	242 hp (180 kw) @ 2000 rpm
Aspiration	turbocharged
Electrical System	12 volt
Alternator	100 amp
Battery	(2) 12V-950 C.C.A. @ 0°F (-18°C)
Fuel Capacity	60 gal (227 l)

SPEED AND GRADEABILITY

Engine Transmission	Speed Range	Gradeability
Cummins Manual	60 mph (96 km/h)	56%
Cummins Automatic	60 mph (96 km/h)	64%

Performance data is based on a gross vehicle weight of 58,000 lb. (26 308 kg). Performance may vary due to engine performance, weight, tire size, etc. Gradeability data is theoretical and is limited by tire slip, vehicle stability, oil pan angle, and other factors.

GENERAL DIMENSIONS

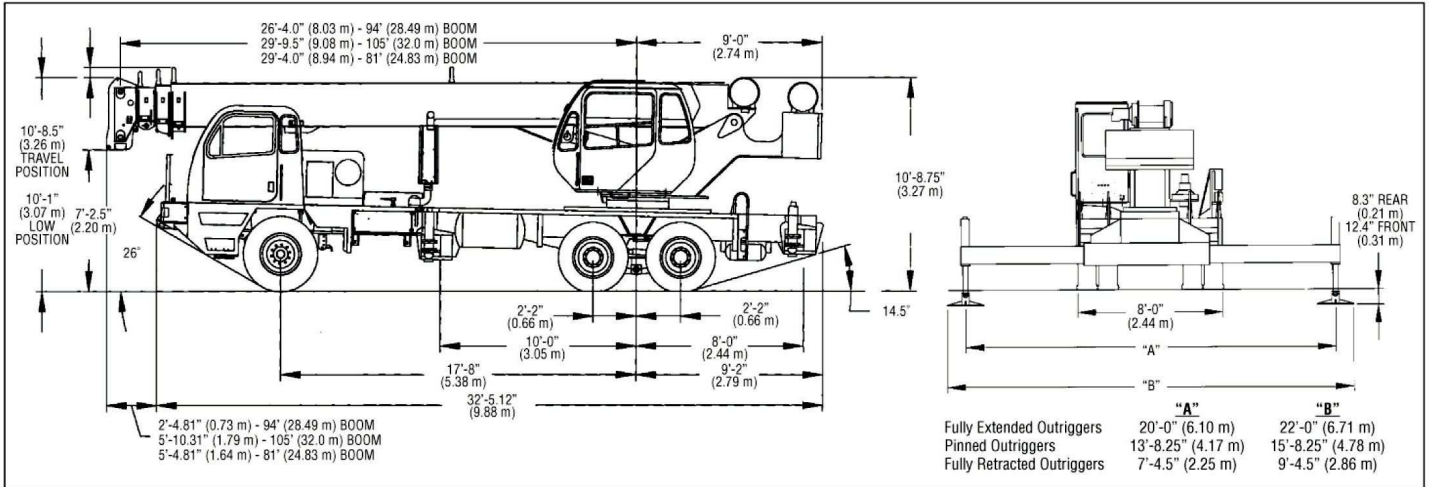

WEIGHTS & AXLE LOADS	GROSS WEIGHT LBS.	UPPER IN TRAVEL POSITION		GROSS WEIGHT KG.	UPPER IN TRAVEL POSITION	
		FRONT	REAR		FRONT	REAR
T 300 Crane with ISC 300 Engine, 94' (28.49 m) Boom, 2,000 + 500 lb. (1633 + 227 kg) Cwt., 1/4 Tank of Fuel, 425/65R22.5-20 PR Front and 11R22.5-14 PR Rear Tires, Aluminum Disc Wheels, and 200 lb. (90.7 kg) Operator in Cab.	47,101	16,576	30,525	21 365	7519	13 846
T 340XL Crane with ISC 300 Engine, 105' (32.0 m) Boom, 11,000 + 1,850 lb. (4990 + 227 kg) Cwt., 1/4 Tank of Fuel, 425/65R22.5-20 PR Front and 11R22.5-14 PR Rear Tires, Aluminum Disc Wheels, and 200 lb. (90.7 kg) Operator in Cab.	60,053	16,515	43,528	27 240	7491	19 749
Add Options:						
32' (9.68 m) Swing-on Jib on 94' (28.49 m) Boom	+ 1,368	+ 797	+ 571	+ 620	+ 362	+ 258
32' (9.68 m) Swing-on Jib on 81' (24.83 m) Boom	+ 1,368	+ 1,030	+ 338	+ 620	+ 467	+ 153
32' (9.68 m) Swing-on Jib on 105' (32.00 m) Boom	+ 1,368	+ 1,117	+ 251	+ 620	+ 507	+ 113
32'-49' (9.68-14.86 m) Swing on Jib on 94' (28.49 m) Boom	+ 1,789	+ 1,004	+ 785	+ 811	+ 455	+ 356
32'-49' (9.68-14.86 m) Swing on Jib on 81' (28.49 m) Boom	+ 1,789	+ 1,307	+ 482	+ 811	+ 593	+ 218
32'-49' (9.68-14.86 m) Swing on Jib on 105' (32.00 m) Boom	+ 1,789	+ 1,343	+ 446	+ 811	+ 609	+ 202
Auxiliary Boom Head on 94' (28.49 m) Boom	+ 100	+ 154	- 54	+ 45	+ 70	- 25
Auxiliary Boom Head on 81' (24.83 m) Boom	+ 100	+ 167	- 67	+ 45	+ 89	- 44
Auxiliary Boom Head on 105' (32.00 m) Boom	+ 100	+ 170	- 70	+ 45	+ 77	- 32
Full Tank of Fuel	+ 315	+ 120	+ 195	+ 142	+ 54	+ 88
Auxiliary Winch W/Drum Roller and Wire Rope	+ 175	- 73	+ 248	+ 79	- 112	+ 191
Heater/Defroster (Upper)	+ 60	- 5	+ 65	+ 27	- 2	+ 25
Work Lights	+ 35	+ 5	+ 30	+ 16	+ 2	+ 18
Sling Box Installed on Left Side of Carrier	+ 87	+ 62	+ 25	+ 40	+ 28	+ 12
Sling Box Installed on Right Side of Carrier	+ 87	+ 31	+ 56	+ 40	+ 14	+ 26
Pintle Hook (Rear)	+ 50	- 26	+ 76	+ 23	+ 12	+ 34
Electric Remote Control	+ 200	+ 100	+ 100	+ 91	+ 45	+ 45
40 ton (36.3 mt) Quick Reeving Hook Block (On Bumper - 4 Sheave)	+ 690	+ 973	- 283	+ 313	+ 441	- 128
7 ton (6.3 mt) Hook and Ball (At boom rack)	+ 240	+ 145	+ 95	+ 109	+ 66	+ 43
Substitute:						
33-81' (10.15-24.83m) Boom w/3,100 lb (1,406 kg) Upper Cwt. & 500 lb (227 kg) F. Bumper	- 640	- 630	- 10	- 290	- 286	- 4
7,200 lb Upper Cwt w/1,850 F. Bumper (94' Boom)	+ 6,636	- 619	+7,255	+ 3010	- 281	+ 3291
7,200 lb Upper Cwt w/1,850 F. Bumper (81' Boom)	+ 5,450	- 121	+5,571	+ 2472	- 55	+ 2527
Aux. Winch W/Drum Roller for Heavy Cwt. (above)	+ 5	+ 5	+ 0	+ 2	+ 2	0
Metallic Boom Head Sheaves	+ 120	+ 196	- 32	+ 54	+ 89	- 35
Front Air Suspension	+ 100	+ 94	+ 6	+ 46	+ 43	+ 3
Rear Air Suspension	+ 344	0	+ 344	+ 156	0	+ 156
Spin Resistant Wire Rope (per winch)	+ 32	- 12	+ 44	+ 14	- 6	+ 20
Automatic Transmission w/2-speed axles	+ 15	0	+ 15	+ 7	0	+ 7
Automatic Transmission w/2-speed aux. trans. & 2-speed axles	+ 510	+ 300	+ 210	+ 231	+ 136	+ 95

NOTE: Weights are for Terex supplied equipment and subject to 2% variation due to manufacturing tolerances.