

# Operator Manual

## AB-46 RT

SERIAL NO. 1000 TO CURRENT

### WARNING

All personnel shall carefully read, understand and follow all safety rules, operating instructions, and the Scaffold Industry Association's MANUAL OF RESPONSIBILITIES (ANSI A92.5) before operating or performing maintenance on any UpRight boom supported aerial work platform.

## SAFETY RULES

### Electrocution Hazard

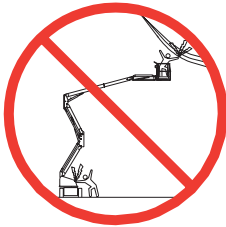

**NEVER** operate the machine within ten (10) feet of power lines. **THIS MACHINE IS NOT INSULATED.**

### Tip Over Hazard

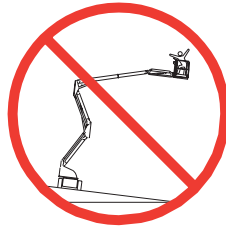

**NEVER** operate the boom or drive with platform elevated unless on firm level surface.

### Collision Hazard

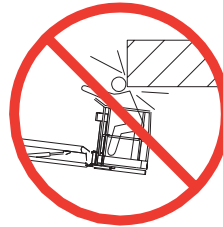

**NEVER** position the platform without first checking for overhead obstructions or other hazards.

### Fall Hazard



**NEVER** climb, stand or sit on platform guard-rails or midrail.

**ALL** occupants must wear an approved fall restraint properly attached to designated platform anchorage point. Attach only one fall restraint to each anchorage point.

**NEVER** exceed maximum platform load of 500 lbs. (225 kg) and two (2) occupants.

**NEVER** exceed 45 lbs. (200 N) of side force per occupant.

**DISTRIBUTE** all platform loads evenly on the platform.

**NEVER** operate the machine without first surveying the work area for surface hazards such as holes, drop-offs, bumps, curbs, or debris; and avoiding them.

**OPERATE** machine only on surfaces capable of supporting wheel loads.

**NEVER** elevate the machine when wind speeds exceed 28 mph (12.5 m/sec.).

**IN CASE OF EMERGENCY** push emergency stop button to cut power to all powered functions.

**ALWAYS** close and secure gate after entering platform.

**NEVER** exit or enter platform while elevated.

**NEVER** use ladders, scaffolding, or other items to gain height; work only from the platform floor.

**NEVER** climb down elevating assembly while platform is elevated.

**INSPECT** the machine thoroughly for cracked welds, loose or missing hardware, hydraulic leaks, loose wire connections, and damaged cables or hoses before using.

**VERIFY** that all labels are in place and legible before using. Refer to page 11 & 12 for label identification.

**NEVER** use a machine that is damaged, not functioning properly, or has damaged or missing labels.

**IF ALARM SOUNDS** while boom is elevated, **STOP**, carefully retract boom and lower platform without rotating. Move machine to a firm, level surface.

**NEVER** attach overhanging loads or use boom as a crane.

**NEVER** alter operating or safety systems without manufacturer's written consent.

**NEVER** charge battery near sparks or open flame. Charging batteries emit explosive hydrogen gas.

**NEVER** replace any component or part with anything other than original UpRight replacement parts without the manufacturer's written consent.

**NEVER** tow the machine. Transport by truck or trailer only.

**AFTER USE**, secure the work platform from unauthorized use by turning both keyswitches off and removing all keys.

### California Proposition 65 Warning

Gasoline and diesel engine exhaust and some of their constituents are known to the State of California to cause cancer, birth defects, and other reproductive harm.

## Introduction

This manual covers the operation of internal combustion powered models of the AB-46 RT Articulated Boom. This manual must be stored on the machine at all times.

## Pre-Operation and Safety Inspection

**Carefully read, understand and follow all safety rules, labels, and operating instructions, then perform the following steps each day before use.**

Perform a complete visual inspection of the entire unit prior to operating. Check the following areas for discrepancies:

1. Open panels and check hydraulic components / hoses for damage or leaks. Check electrical components / wiring for damage or loose connections.
2. Inspect chassis, axles, hubs, and steering linkage for damage, deformation, buckled paint, loose or missing hardware, and cracked welds.
3. Check tires for damage, punctures, and inflation; tire pressure must be 55 psi.
4. Check all hoses / cables for wear.
5. Inspect elevating assembly for damage, deformation, buckled paint, loose or missing hardware, and cracked welds.
6. Inspect platform and guardrails for damage, deformation, buckled paint, loose or missing hardware, and cracked welds. Insure that gate operates freely and latches securely.
7. Check Hydraulic fluid level with platform fully lowered.
8. Check battery fluid level (see battery maintenance, page 9).
9. Check fuel level, add fuel if necessary (see *fueling*, page 9).
10. Ensure that radiator is cold, check coolant level. Add if necessary.



### WARNING



NEVER remove the cap from a hot radiator. Hot coolant can cause severe burns.

## SYSTEM FUNCTION INSPECTION

**Note: Refer to figures 1 and 2 for chassis and platform control locations.**

1. Before performing the following tests, check area around machine and overhead for obstructions, holes, drop-offs, and debris.

2. Turn chassis key switch to chassis, and turn on (rotate clockwise) emergency stop switches at the chassis control panel and at the platform control panel.
3. Press the engine start button to crank the engine; release when engine starts. If engine is cold: press the preheat button and hold for six seconds prior to starting diesel models.
4. Push in the chassis emergency stop button engine should stop. Repeat for platform emergency stop button. Return both emergency stop buttons to the on position, and start engine.
5. Operate each function switch to raise / lower, extend / retract, rotate left / right, each section of the elevating assembly and observe the operation of the machine. All functions should operate through full cycle smoothly.
6. Turn chassis key switch to platform.
7. Mount the platform, close and latch the gate, and attach approved fall restraint to designated platform anchorage point. Attach only one fall restraint to each point.
8. Start the engine.
9. Without depressing the foot switch, move the drive control handle, machine should not function.
10. Depress the foot switch and move the drive control handle forward and reverse. Observe that proportional functions operate smoothly, and that brakes apply quickly after control is released.
11. While depressing foot switch, operate steer switch to left and right. Observe that steering wheels turn properly.
12. While depressing foot switch, turn function speed control knob to desired setting, and operate boom controls. Observe that boom operates smoothly, and that upper boom, jib, turret rotation, platform level, and platform rotation controls operate proportionally in conjunction with function speed control knob. Observe that platform maintains level when boom is elevated.
13. With the upper boom elevated one foot, operate drive control handle. Observe that drive speed is limited to creep approximately (1 foot [.3m] per second). Lower upper boom to stowed position.
14. Press the service horn button. Observe that horn is audible.



### WARNING



DO NOT use a machine that is damaged or malfunctioning. Tag and remove the unit from service until it is repaired.

## Controls and Indicators

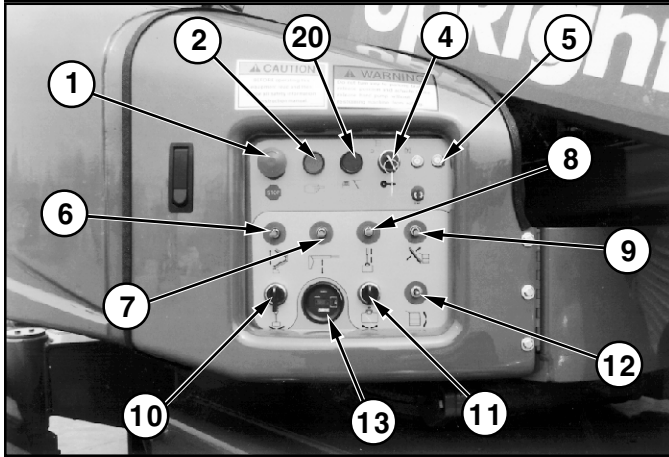

**Figure 1: Chassis Controls**

**Note:** The following list corresponds to the numbered items in figures one and two.

1. Emergency stop.
2. Engine start.
3. Speed Selector.
4. Keyswitch.
5. Control fuses.
6. Riser control.
7. Upper boom control.
8. Boom extension control.
9. Jib control.
10. Turret rotation control.
11. Platform rotation control.
12. Platform level control.
13. Hourmeter.
14. Service horn button.
15. Drive control handle.
16. Function speed control.
17. Fuel selector (dual fuel).
18. Foot switch (located on platform floor).
19. Out of level indicator.
20. Preheat button (diesel).

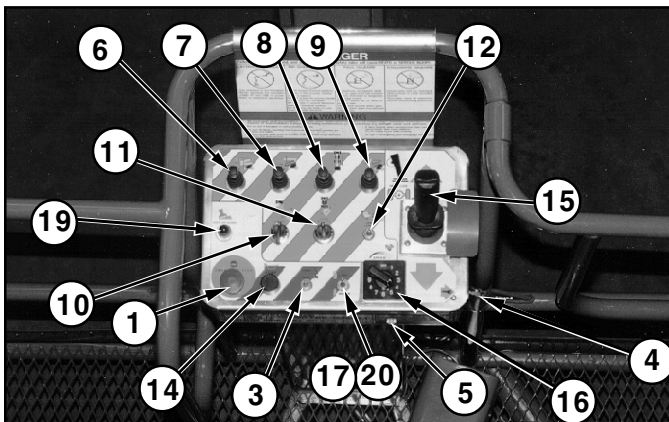

**Figure 2: Platform Controls**

## Operation

Before operating work platform insure that:

Pre-operation and safety inspection has been completed, and any discrepancies have been corrected.

The operator has been thoroughly trained on the operation of the machine.

The work area is clear of all obstructions, holes, drop-offs, or persons in the route of travel.

The surface is capable of supporting wheel loads.

Refer to figures one and two for control locations.



### Emergency Stop

At any time during operation, press the emergency stop button to stop all functions in an emergency.



### Service Horn

At any time during operation, press the service horn button to sound an audible warning if necessary.

### **WARNING**

**Always** wear an approved fall restraint properly attached to designated platform anchorage point when driving or elevating the machine (see figure 3).

Attach only one fall restraint to each anchorage point.

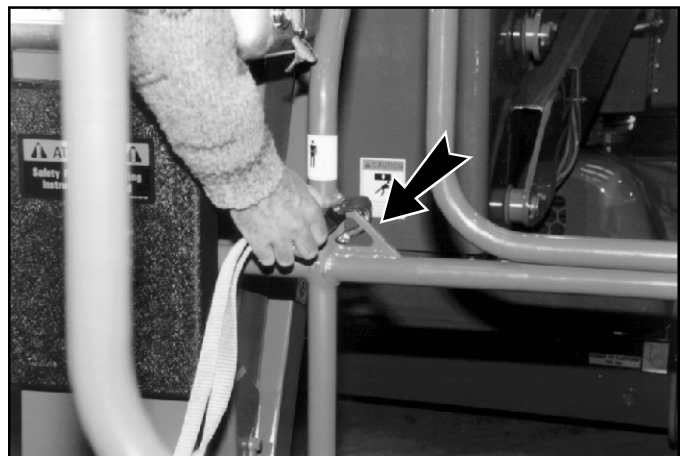

**Figure 3: Typical Fall Restraint Anchorage Point**



## Starting the engine

### From the lower controls

1. Turn the chassis key switch to chassis position.
2. Press the start button to crank the engine. Release when the engine starts.
3. When the engine is cold: press and hold the preheat button while starting the diesel engine.

**Note: Do not depress the foot switch when cranking engine, as this may flood engine.**

### From the platform controls

1. Turn the chassis key switch to platform controls.
2. Turn the platform keyswitch fully clockwise to crank the engine. Release when engine starts.
3. When the engine is cold: Press and hold the preheat button while starting the diesel engine.

**Note: Do not depress the foot switch when cranking engine, as this may flood engine.**



## Driving

### With Boom Lowered

The AB-46 RT has two drive speeds when the boom is lowered to efficiently accommodate varying terrain.

**Lo Speed:** The Lo speed capability allows the machine to be easily maneuvered through rougher terrain and negotiate steeper slopes.

**Hi Speed:** The Hi speed capability is convenient for maneuvering in areas that are relatively smooth and where the machine will not be driven over rough or sloping terrain.

1. Turn chassis key switch to platform, and turn on (turn clockwise) the chassis emergency stop switch.
2. Mount the platform, close and latch the gate.

3. Attach approved fall restraint to designated platform anchorage point. Attach only one fall restraint to each point.
4. Start engine.
5. Check that the area around and above the work platform is clear of obstructions, holes, drop-offs, persons in the route of travel, and the surface is capable of supporting wheel loads.
6. Examine the terrain and place the speed selector switch in the appropriate position (Hi or Lo).
7. Depress the foot switch and move the drive control handle forward to travel forward and reverse to travel in the reverse direction.
8. While driving in HI speed, pressing the button, located on the front of the drive control handle, will shift momentarily into LO for improved torque.

**Note: When the boom is rotated to the front of the chassis (steering wheels aft) directions of travel and steering will be reversed. Observe the color coded arrows on the control panel near the drive control handle, and on the chassis. They will indicate the direction of travel when the drive control handle is moved.**

**The front axle will oscillate freely through a limited range when driving for greater ease of negotiating irregular terrain.**

### With Boom Elevated

**Travel with boom elevated is restricted to firm level surfaces only. When the articulating front axle is not level, it will lock into position and disable the drive function.**

When driving elevated, the machine will travel at creep speed (1 foot [.3 m] per second).

### Steering

1. While depressing the foot switch, push the steering switch (located on top of the control handle) to the left to turn left, and right to turn right.

**Note: Steering is not self centering. Wheels must be returned to the straight ahead position by operating the steering switch.**

## POSITIONING THE PLATFORM

Positioning the platform as close as possible to the work area requires some planning. First, you must survey the work site to find a suitable place to park the machine. This must be a firm level area as close as possible to the work area. Take into consideration all obstructions on the ground and overhead and avoid them.

Once you have moved the machine to a firm level surface as near as possible to the work area, follow the instructions on page five to position the platform as close to the work area as possible.

Always, before operating any function, check the area around and overhead for any obstructions or electrical conductors.

**⚠ WARNING ⚠**

**NEVER** exit the platform while the boom is elevated. Keep both feet firmly planted on the platform floor at all times.

## Multifunction Controls

The UpRight AB-46 RT employs the use of multifunction controls. This means that riser or boom extension will function at full speed while simultaneously operating upper boom, jib, turret, or rotating the platform.

The turret may be rotated while driving when boom is lowered if necessary to make turns in tight areas. No other boom functions will operate while driving.

## Lower Control Operation

All boom functions will operate at fixed speed. Those which are adjustable will operate at the speed set on the platform control.

1. Turn chassis keyswitch to chassis controls.
2. With engine running, operate boom control switches to position the platform.



## Leveling the Platform

**⚠ WARNING ⚠**

**DO NOT** operate the machine if the platform does not maintain level when elevated.

**Note: Platform leveling can be performed only with the boom stowed and should be done only to calibrate the automatic leveling system.**

1. Set the function speed control dial to the desired setting. Rotate the dial clockwise to increase speed, counterclockwise to decrease. If you are not sure what speed to use, start out slow; the speed can be varied while operating the function.
2. While depressing the foot switch, push the platform level control switch forward to swing the platform upward, rearward to swing the platform downward. Release the switch to stop leveling.

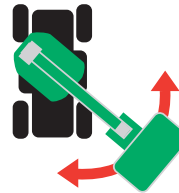

## Rotating the Turret

1. Set the function speed control dial to the desired setting. Rotate the dial clockwise to increase speed, counterclockwise to decrease. If you are not sure what speed to use, start out slow; the speed can be varied while operating the function.
2. While depressing the foot switch, turn the turret rotation control switch counterclockwise to rotate left, clockwise to rotate right. Release the switch to stop rotation. Observe the area around the boom when rotating the turret to avoid any obstructions.

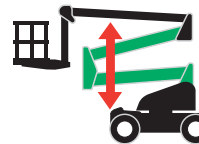

## Elevating the Riser

1. While depressing the foot switch, push the riser control lever forward to elevate the riser, rearward to lower the riser. Release the control lever to stop elevating / lowering. The riser will function at a constant speed, function speed control setting is not necessary.

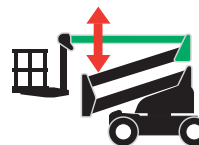

## Elevating the Upper Boom

1. Set the function speed control dial to the desired setting. Rotate the dial clockwise to increase speed, counterclockwise to decrease. If you are not sure what speed to use, start out slow; the speed can be varied while operating the function.
2. While depressing the foot switch, push the upper boom control lever forward to elevate the upper boom, rearward to lower the upper boom. Release the control lever to stop elevating / lowering.

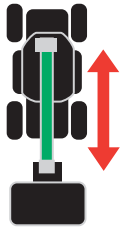

## Extending the Upper Boom

1. While depressing the foot switch, push the boom extension control lever rearward to extend the boom, forward to retract the boom. Release the control lever to stop extending / retracting. The boom extension will function at a constant speed, function speed control setting is not necessary.

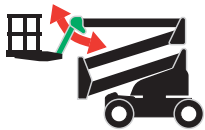

## Elevating the Jib

1. Set the function speed control dial to the desired setting. Rotate the dial clockwise to increase speed, counterclockwise to decrease. If you are not sure what speed to use, start out slow; the speed can be varied while operating the function.
2. While depressing the foot switch, push the jib control lever forward to elevate the jib, rearward to lower the jib. Release the control lever to stop elevating / lowering.

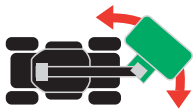

## Rotating the Platform

1. Set the function speed control dial to the desired setting. Rotate the dial clockwise to increase speed, counterclockwise to decrease. If you are not sure what speed to use, start out slow; the speed can be varied while operating the function.
2. While depressing the foot switch, turn the platform rotation control switch counterclockwise to rotate left, clockwise to rotate right. Release the switch to stop rotation.

## EMERGENCY OPERATION

In the event of powered function failure, the elevating assembly may be lowered manually by the following procedure.



### WARNING



**NEVER** climb down the elevating assembly. If controls do not respond, ask someone on the ground to lower the boom manually.

## Lowering Elevating Assembly

1. Open the cover on the hydraulic module (opposite side of the turret from the chassis control panel).
2. Remove the wire loop retainer from the hand pump lever, and extend the handle upward to gain leverage.
3. Operate the manual override (knurled knob) on the appropriate valve (see fig. 4). Push in to lower / extend, pull out to raise / retract as required.
4. While holding the appropriate valve in position, pump the handle in and out until that section of the elevating assembly is lowered / retracted.
5. Repeat as necessary operating each valve until the elevating assembly is fully lowered.

**Note: Use of the hand pump causes a diverter valve to open disabling normal controls. The valve will remain open until pressure is bled off. After operating any function with the hand pump, cycle the jib valve in and out 6 times to bleed off pressure.**

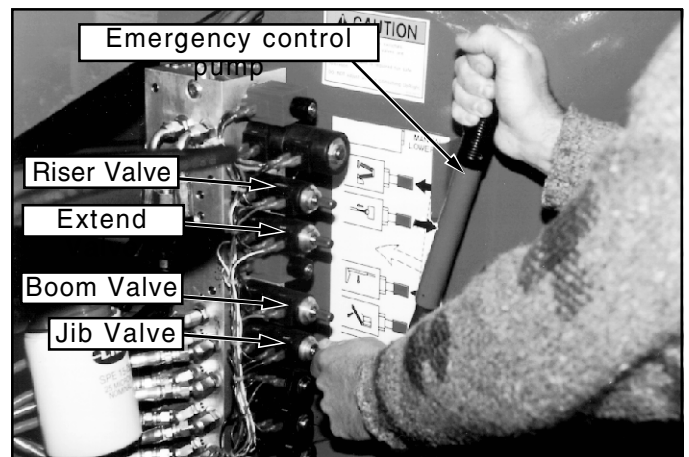
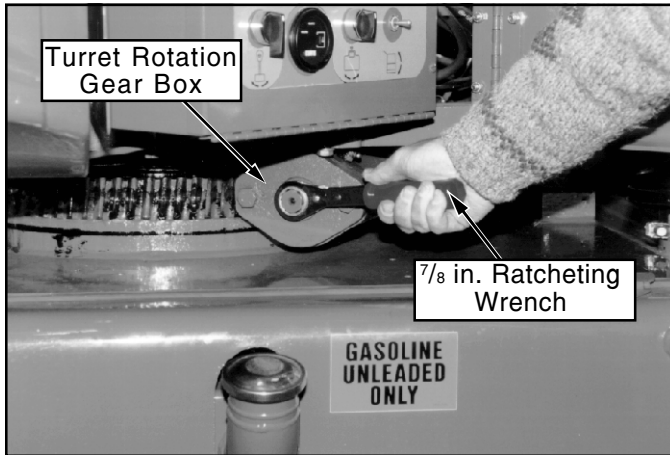

Figure 4: Emergency Control Operation

## Rotating Turret

1. To manually rotate the turret, remove the manual turret crank from inside of the control side turret cover.
2. Set ratchet direction on turret crank.
3. Place the socket of the crank onto the hex shaft stub of the turret rotation gearbox.
4. Turn the crank clockwise to rotate the turret counterclockwise, turn counterclockwise to rotate the turret clockwise.



**Figure 5: Manual Turret Rotation**

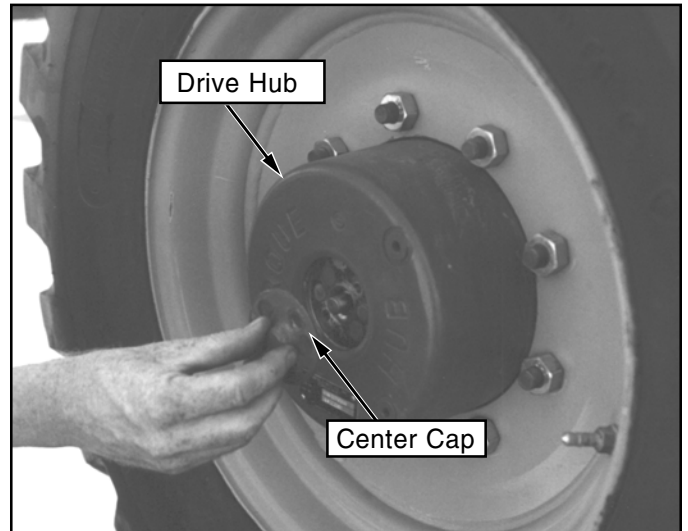

**Figure 6: Disengaging Drive Hub**

## EMERGENCY TOWING

Perform the following only when the machine will not operate under its own power and it is necessary to move the machine or when winching onto a trailer for transportation.

1. Insure that the platform is fully lowered, and that the turret is rotated so that the platform is to the rear of the machine.
2. Attach chain / cable of sufficient strength for towing the machine to front or rear tie down lugs.

### **⚠ WARNING ⚠**

Chock wheels before disengaging hubs.  
Machine may roll.

3. Refer to figure 6 and disengage all four drive hubs. Remove two screws and center cap. Reinstall center cap in the opposite direction.
4. When ready to move the machine, remove the chocks. Tow or winch into position and replace chocks.
5. Engage all four drive hubs by returning the center caps to their original orientation.

### **⚠ CAUTION ⚠**

DO NOT move the machine faster than 3 mph. Faster speeds will damage drive components and void warranty.

## AFTER USE EACH DAY

1. Ensure that the platform is fully lowered.
2. Park the machine on level ground, preferably under cover, secure against vandals, children or unauthorized operation.
3. Turn the upper key switch to **OFF**, the lower key switch to **platform** and remove all keys to prevent unauthorized operation.

## Transportation

### BY CRANE

#### **WARNING**

Stand clear of machine when lifting.  
Check specifications on back page, insure that crane and slings are of correct capacity to lift weight of unit.

1. Insure that boom is fully lowered and retracted.
2. Attach straps to chassis lifting lugs only. Insure that straps are adjusted properly to keep unit level when lifting.

### BY TRUCK OR TRAILER

1. Insure that boom is fully lowered and retracted.
2. Maneuver the machine onto bed of truck / trailer.
3. When winching, follow instructions for emergency towing on page 7. Attach winch cable to front tie down lugs.

#### **CAUTION**

Do not winch machine faster than 3 mph.

4. After winching, insure that brakes are set.
5. Secure the machine to the transport vehicle using chains / straps of adequate load capacity (refer to specifications, back page) attached to chassis tie down lugs (see figure 7).
6. Place a wooden block (10.5" x 6" x 35") under platform support braces as shown (see figure 7).
7. Attach ratchet strap; under platform floor grating, over support braces (see figure 7). Tighten securely, do not overtighten.

#### **WARNING**

NEVER elevate the machine while on a truck or trailer.

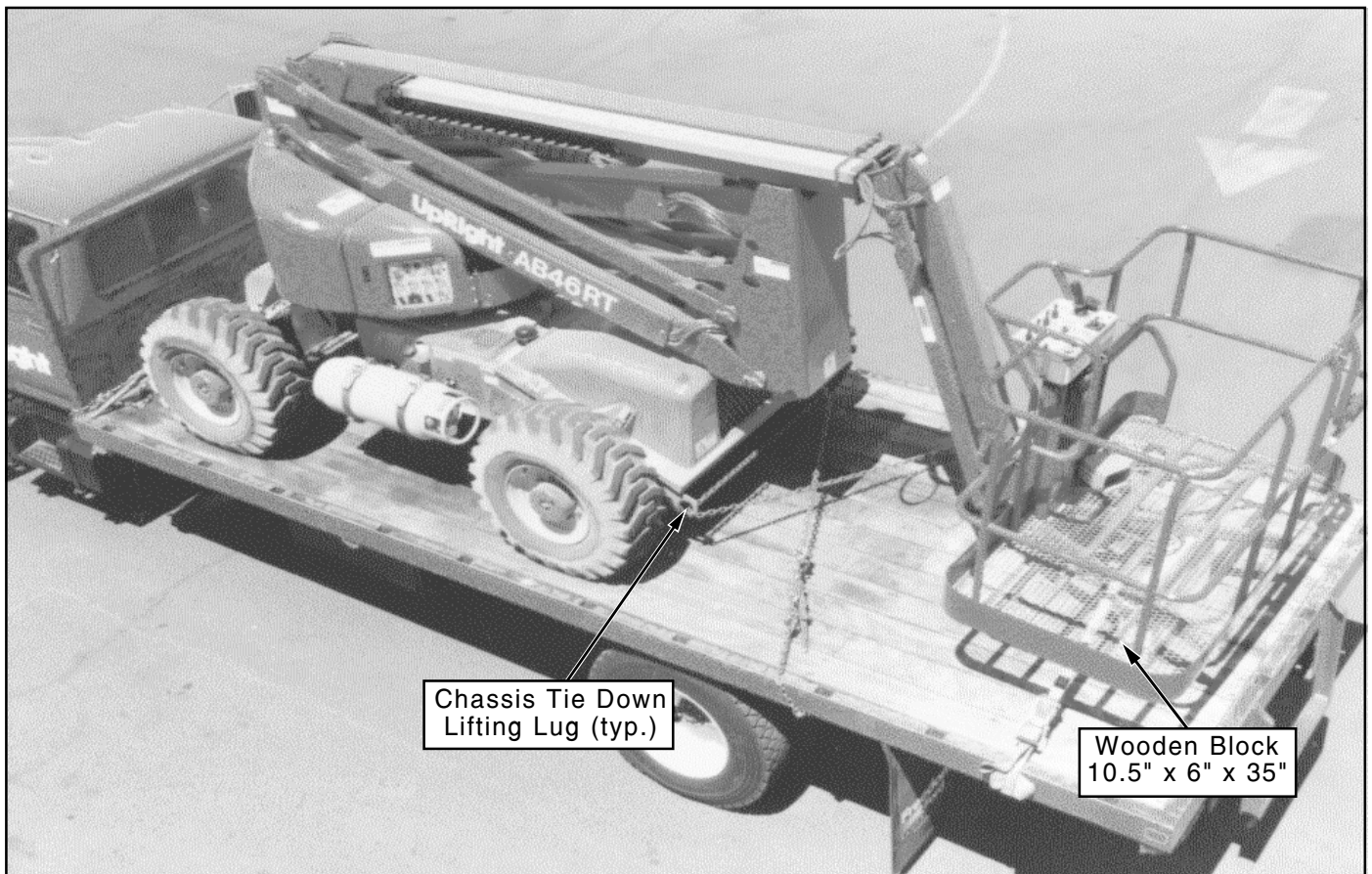

Figure 7: Securing the Machine for Transportation



# Maintenance

## FUELING

### Gasoline

1. Open fill pipe cap located on chassis left side (see figure 8).
2. Fill to capacity with unleaded motor fuel only.
3. Check fuel level by lifting flap located on top of chassis left side (see figure 8). Fuel tank full capacity is 25 US gallons.

### Diesel

1. Open fill pipe cap located on chassis left side (see figure 8).
2. Fill to capacity with diesel motor fuel only, grade #1-D, or #2-D. Use distillate fuel only, do not use residual or blend.
3. Check fuel level by lifting flap located on top of chassis left side (see figure 8). Fuel tank full capacity is 25 US gallons.

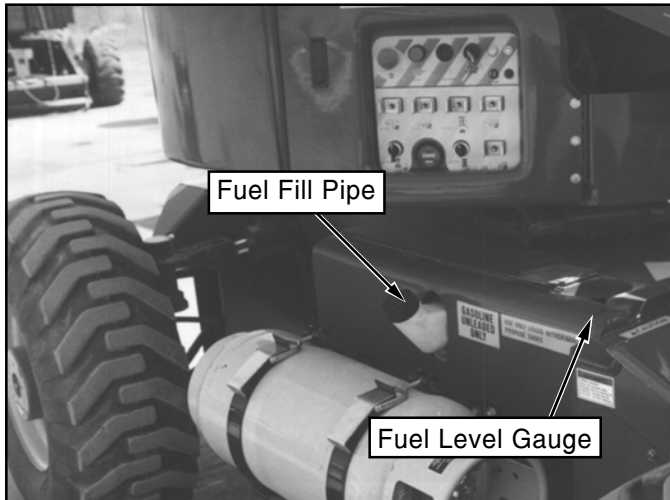

Figure 8: Fuel Fill Pipe and Level Gauge

## HYDRAULIC OIL

1. Check oil level at sight gauge inside engine compartment right hand side with the platform fully lowered.
2. If necessary, fill to capacity with clean ISO 46 compatible hydraulic oil.
3. Lift flap located on top of chassis right side (see figure 9).
4. Open filler / breather cap to add hydraulic oil.
5. Replace cap.

## LUBRICATION

Refer to service manual for lubrication chart and guidelines.

## BATTERY MAINTENANCE

### ⚠ WARNING ⚠

Hazard of explosive gas mixture. Keep sparks, flame and smoking materials away from batteries.

Always wear safety glasses when working with batteries.

Battery fluid is highly corrosive. Rinse away any spilled fluid thoroughly with clean water.

Always replace batteries with UpRight batteries or manufacturer approved replacements weighing 62 lbs. each.

Check battery fluid level daily, especially if work platform is being used in a warm, dry climate.

If electrolyte level is lower than 3/8 in. (10 mm) above plates add distilled water only. DO NOT use tap water it will shorten battery life.

Keep terminals and top of battery clean.

## TIRES

Tire selection can affect the stability of the machine. Use only tires supplied by UpRight unless approved by the manufacturer in writing.

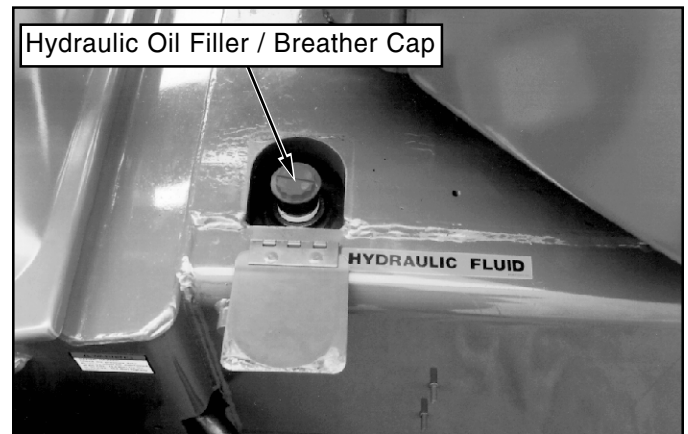

Figure 9: Hydraulic Oil Filler / Breather Cap

## ROUTINE SERVICE

Use the following table as a guide for routine maintenance. **Inspection and maintenance shall be performed by personnel who are trained and familiar with mechanical and electrical procedures.** Refer to the Service Manual for complete service instructions.

Please copy this page and use the Routine Service Table as a checklist when inspecting a machine for service.

## Routine Service Table Key

### Interval

Daily=each shift (every day) or every eight hours  
 30D=every month (30 days) or every 50 hours  
 3M=every 3 months or 125 hours  
 6M=every 6 months or 250 hours  
 1Y=every year or 500 hours  
 2Y=every 2 years or 1000 hours

Y=Yes/Acceptable

N=No/Not Acceptable

R=Repaired/Acceptable

## Routine Service Table

COMPONENT	INSPECTION OR SERVICES	INTERVAL	Y	N	R
Engine Oil	Check level and condition	Daily			
	Check for leaks	Daily			
	*Change oil & filter (Dual Fuel)	100HOURS			
	*Change oil & filter (Diesel)	200HOURS			
Engine Fuel System	Check fuel level	Daily			
	Check for leaks	Daily			
	Replace fuel filter	6M			
Engine Air Cleaner	Replace air cleaner	6M			
	Check air cleaner	Daily			
Battery	Check electrolyte level	Daily			
	Clean exterior	3M			
	Clean terminals	3M			
Engine Coolant	Check coolant level (with engine cold)	Daily			
	Replace coolant	3M			
Hydraulic Oil	Check oil level	Daily			
	Change filter	6M			
	Drain and replace with ISO 46 compatible oil	2Y			
Hydraulic System	Check for leaks	Daily			
	Check hose connections	30D			
	Check hoses for exterior wear	30D			
Emergency Hydraulic System	Check operation of emergency override valves and hand pump	Daily			
Controller	Check operation of all controls	Daily			
Platform	Check fasteners for proper torque	Daily			
Floor and Rails	Check welds for cracks	Daily			
	Check condition of platform	Daily			
	Check condition of anchorage points	Daily			
	Check condition of operators manual	Daily			
Tires	Check for damage	Daily			
	Check air pressure (55 psi)	Daily			
	Check lug nuts (torque to 90 ft. lbs. [123 Nm])	30D			
Hydraulic Pump	Wipe clean	30D			
	Check for leaks at mating surfaces	30D			
	Check for hose fitting leaks	Daily			
	Check mounting bolts for proper torque	30D			
Hydraulic Drive System	Check hydraulic drive motor operation	Daily			
	Check hoses, fittings, and valve block for leaks	Daily			
Steering System	Check fittings for proper torque	6M			
	Oil all pivot points	30D			
	Check steering cylinder for leaks	30D			
	Check linkage for wear areas	30D			
	Check for missing / loose retainers	Daily			

COMPONENT	INSPECTION OR SERVICES	INTERVAL	Y	N	R
Elevating Assembly	Inspect for structural cracks	Daily			
	Check pivot points for wear	30D			
	Check pivot pin retaining bolts for proper torque	30D			
	Check members for deformation	Daily			
Chassis	Check hoses for pinch or rubbing points	Daily			
	Check component mounting for proper torque	6M			
	Check welds for cracks	Daily			
Turret	Check ring gear for proper lubrication and wear	Daily			
	Lubricate worm gear bearings	150H/3M			
	Lubricate ring gear (MoS <sub>2</sub> grease)	150H/3M			
Drive Hubs	Check for leaks	Daily			
	Check oil level	250H/6M			
	Change oil after break-in period	50H/30D			
	Change oil (SAE 90 wt. gear oil)	2000H/2Y			
Lift Cylinders	Check the cylinder rods for wear	30D			
	Check pivot pin retaining bolts for proper torque	30D			
	Check seals for leaks	30D			
	Inspect pivot points for wear	30D			
	Check fittings for proper torque	30D			
Entire Unit	Check for and repair collision damage	Daily			
	Check fasteners for proper torque	3M			
	Check for corrosion, remove and repaint	3M			
	Lubricate	30D			
Labels	Check for peeling, missing, or unreadable labels & replace	Daily			
Slew Ring	Check fasteners for proper torque	30D			

\* First oil change after 50 hours.

## Service Report

Date: \_\_\_\_\_  
 Owner: \_\_\_\_\_  
 Model No: \_\_\_\_\_ Serial No: \_\_\_\_\_  
 Serviced By: \_\_\_\_\_  
 Service Interval: \_\_\_\_\_

**Note: Labels can be ordered by using Part Number located by each label.  
For machines equipped with options, consult the Service Manual.**

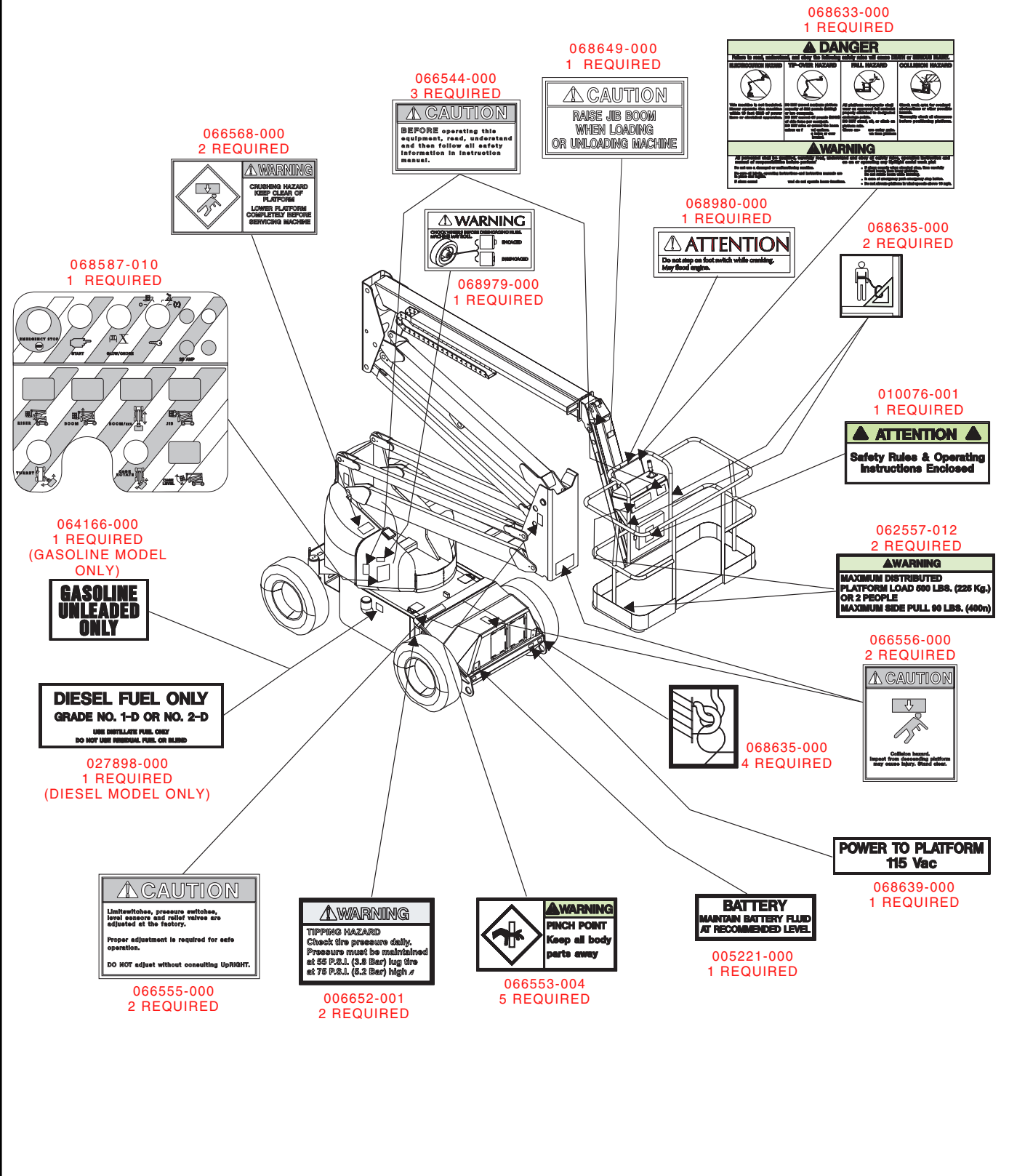

**Figure 9: Label Identification**

Figure 9: Label Identification (cont.)

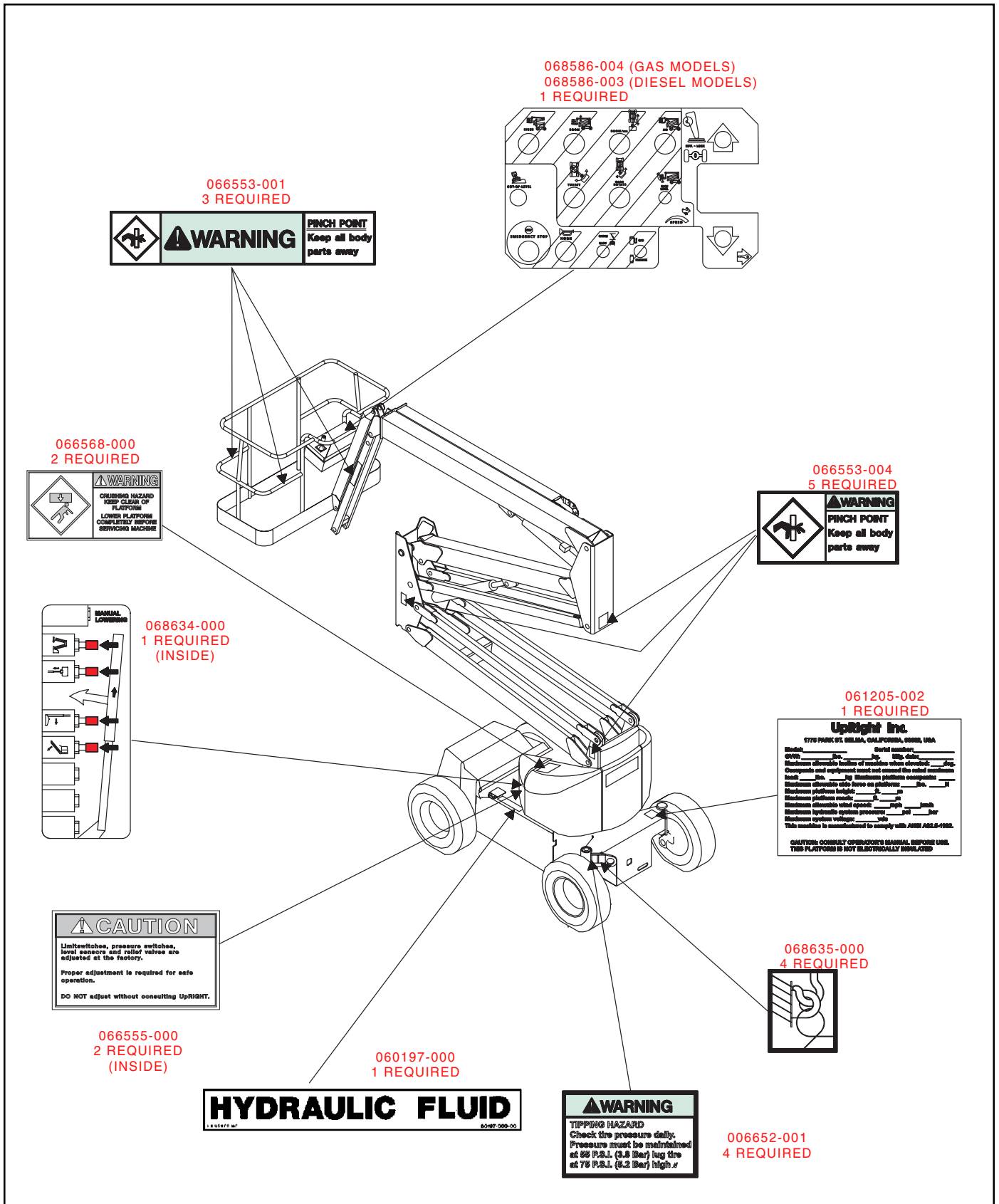

**AB - 46 Label Installation: All of the labels shown in figure 9 shall be present and in good condition before operating the work platform. Be sure to read, understand and follow these labels when operating the work platform.**

NOTES:

NOTES:

NOTES:

# Specifications\*

Safety Rules and Operating Instructions

Safety Rules and Operating Instructions

ITEM	SPECIFICATION
Height	
Working height maximum	52 ft. 10 in.
Platform height maximum	46 ft. 10 in.
Platform step in height	19 in.
Up and over height	25 ft. 8 in.
Drivable height	46 ft. 10 in.
Horizontal outreach	24 ft. 6 in.
Turret rotation	360 deg. noncontinuous
Platform rotation	160 deg.
Tail swing	None
Jib length	5 ft.
Jib arc	140 deg.
Inside turning radius	3 ft.
Outside turning radius	12 ft.
Drive speed (lowered)	4.5 mph
Drive speed (elevated)	.6 mph
Gradability	40%
Platform Size	69 in. x 39 in.
Guardrail height	43 1/2 in.
Toeboards	6 in.
Maximum platform capacity	500 lbs.
Maximum no. of occupants	2
Weight (Gas Model)	14,460 lbs.
Weight (Diesel Model)	14,660 lbs.
Overall height	7 ft. 4 in.
Overall length	18 ft. 4 in.
Overall width	6 ft. 7 in.
Wheel base	7 ft. 2 in.
Wheel track	5 ft. 5 in.
Ground Clearance	13 in.
Power source (Gas Model)	Ford VSG 413
Power source (Diesel Model)	John Deere 3015DF
System voltage	12VDC
Maximum Hyd. Pressure	5000 psi
Controls	Electric Proportional
Tires	14x17.5 10 ply lug tread

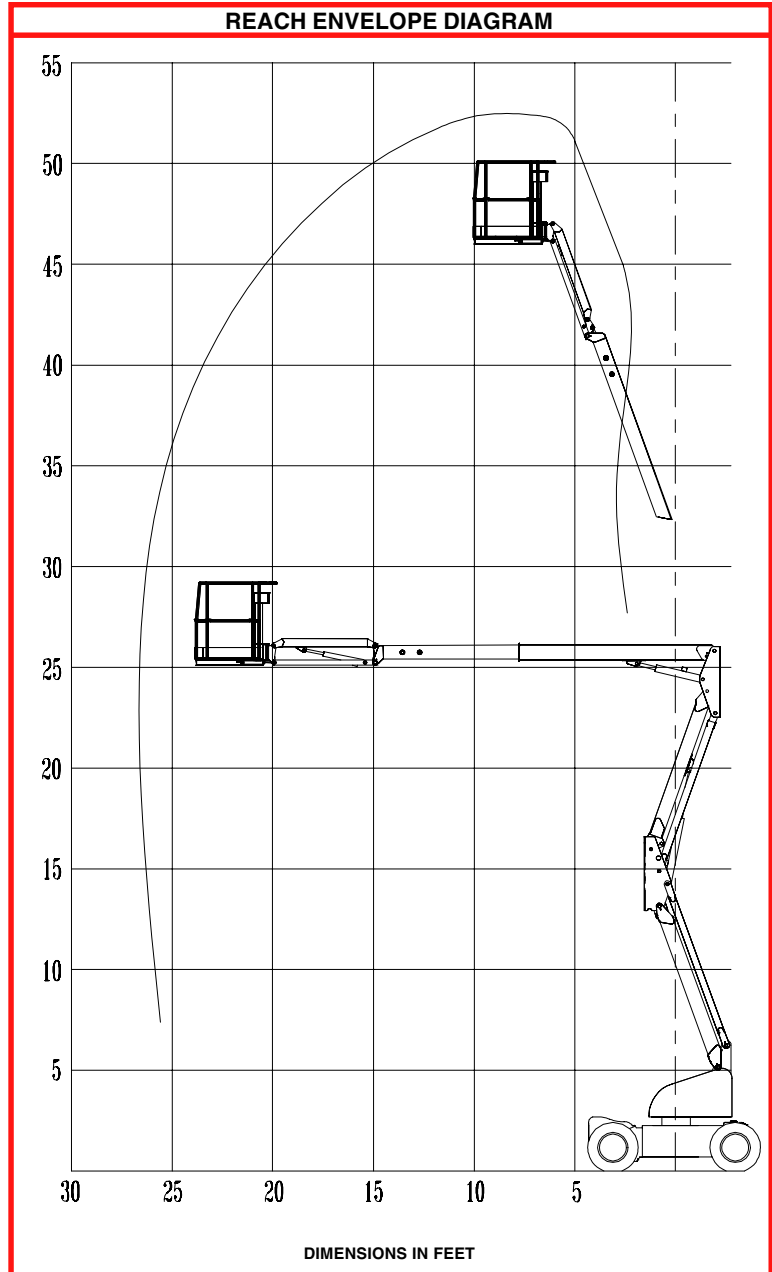

\* Specifications subject to change without notice.  
 Refer to Service Manual for complete parts and service information.  
 Meets or exceeds all applicable requirements of OSHA and ANSI A92.5-1992

## FOR MORE INFORMATION

**UpRight**

Local Distributor:

TEL: (1) 800-926-5438 or (1) 559-662-3900  
 FAX: (1) 559-673-6184  
 Parts FAX: (1) 800-669-9884  
 801 South Pine Street  
 Madera, California 93637  
<http://www.upright.com>