

Compact large milling machine for dual flush-to-kerb milling.
Cold Milling Machine W 200 Hi



Outstanding features of the W 200 Hi cold milling machine

02
03

4 |

MACHINE FRAME

- > **Perfect visibility**
Slender machine frame design at the front including dual wasp waist for a perfect view of the milling edge.
- > **Ease of transport**
Ease of transport due to low machine weight and variable supplementary weights of up to 1,100 kg.

3 |

ENGINE STATION

- > **Three different milling drum speed options**
Three selectable cutting speeds for optimum milling performance in a broad range of applications.
- > **Load-controlled fan speed**
Fan speed governed by engine temperature for low energy consumption and low noise emission levels.

2 |

ELECTRICAL SYSTEM

- > **Emergency operation**
Electrohydraulic power pack to raise machine in emergency mode.
- > **Camera system**
Robust camera system including up to six cameras and up to two screens.
- > **Job data**
Precise recording of job data including "truck full" message.

1 |

LEVELLING

- > **Large choice of sensors**
LEVEL PRO automatic levelling system as standard equipment, offering a large choice of sensors and highly precise control of the milling depth.
- > **Milling depth indicator**
Milling depth indicator on the LEVEL PRO screen (showing difference between scraper blade and side plate positions).
- > **Scanning in front of the milling drum**
Scanning in front of the milling drum by means of an ultrasonic sensor.
- > **Automatic system to initiate the milling process**
Automatic system to initiate the milling process with load-controlled lowering speed.



5 |

OPERATOR'S PLATFORM

> Multifunctional joystick

Multifunctional joystick with driving, steering, selecting operating mode, raising machine and switching off conveyor functions.

> Ergonomics

Ergonomically designed, backlit controls for non-tiring, productive working.

> Protective canopy

Protective canopy with telescoping side panels for maximum protection from inclement weather.

> Parallel alignment of machine

Automatic parallel alignment of the machine both during the milling operation and in transport mode.

6 |

CONVEYOR SYSTEM

> Large slewing angles

Conveyor slewing angles of 60° to both sides to optimize the loading process.

> Tremendous conveying capacity

High conveyor loading capacity and drive power for highly efficient material loading.

> Vacuum Cutting System

Vacuum Cutting System for improved visibility.

> Folding conveyor with locking mechanism

Folding conveyor with intelligent mechanical locking mechanism for easy transport.



7 |

MILLING DRUM UNIT

> Side-moving milling drum unit

Milling drum unit movable by 400 mm each to the left and right hydraulically to allow dual flush-to-kerb milling.

> HT22 quick-change toolholder system

Extra efficient, tried-and-tested HT22 quick-change toolholder system as standard equipment.

> Side plate lift of 420 mm left and right

Side plates left and right can be raised by up to 420 mm to allow flush-to-kerb milling at the full milling depth.

> Load-controlled water spray system

Water spray system with automatic adjustment to the milling performance for optimum tool cooling.

> Milling drum turning device

Drum turning device to enable cutting tool replacement with the diesel engine switched off.

8 |

TRACTION DRIVE

> Hydraulic pre-tensioning of track chains

Hydraulically pre-tensioned track chains for optimized operation.

> Traction control

Intelligent electronic traction control system for the track units.

> Track speed adjustment

Electronic adjustment of the track speed during cornering to ensure maximum traction and low wear and tear.

> Four-fold full-floating axle

Four-fold full-floating axle for optimum machine stability.





Maximum flexibility

in everyday operation.

THE W 200 Hi LARGE MILLING MACHINE - PERFECTLY ENGINEERED MULTIPURPOSE MACHINE OFFERING MAXIMUM FLEXIBILITY IN CHALLENGING OPERATIONS. INCLUDING THE SIDE-MOVING MILLING DRUM UNIT. TAILORED TO PRECISELY FIT CUSTOMER SPECIFICATIONS. INNOVATIVE. IN LINE WITH FIELD REQUIREMENTS. PRODUCTIVE. APPLICATION-RELATED AND SOLUTION-DRIVEN EXPERTISE FROM WIRTGEN. OFFERING MAXIMUM EFFICIENCY TO OUR CUSTOMERS.



The milling drum unit including hydraulically driven milling drum can be moved to the left and right by 400 mm each.

Ultra-flexible large milling machine

ON THE ROAD OF SUCCESS WITH TWO ZERO-CLEARANCE SIDES

The W 200 Hi cold milling machine from WIRTGEN offers a working width of 2.1 m, enabling it to complete all types of large-scale rehabilitation jobs quickly and at low cost. It is the ideal candidate especially for large, high-profile projects carried out in restricted space conditions where, for example, the milling machine needs to travel along with the flowing traffic. Innovative recipe for success: the W 200 Hi features zero clearance for flush-to-kerb milling not only on the right but on both machine sides.

In addition, the milling drum unit of the W 200 Hi can be moved hydraulically by 800 mm altogether, enabling it to mill around obstacles with the greatest ease.

The machine's range of innovative features is completed by three adjustable milling drum speeds for maximum milling performance in every job, the economical WIDRIVE milling machine management system, LEVEL PRO automatic levelling system and VCS Vacuum Cutting System.

1 |



2 |



1 | The W 200 Hi features zero-clearance sides on the left and right in a single machine.

2 | Easy handling of the large milling machine, its comprehensive camera equipment and perfect visibility allow effective one-man operation.

High productivity - even when things get tight

FLEXIBILITY IS THE KEY

Flush-to-kerb milling along kerbstones or concrete safety barriers both on the left and right side can be performed with a single machine and without the need for turning manoeuvres. This is of particular advantage in terms of optimized logistics especially on motorways

as trucks can pull out of and merge back into the flowing traffic quickly and safely in the direction of travel.

The W 200 Hi plays its trump cards also when operating on narrow roads or in urban traffic where space is usually restricted. Thanks to its movable milling drum unit, it can simply mill around obstacles such as storm drains or streetlamps. The side plates on the left and right can be lifted by 420 mm each in order to enable milling flush to kerb even at large working depths. For adequate performance regardless of the job to be completed, the large milling machine is equipped with a high-powered diesel engine.





Cut cost – boost revenue

THREE DIFFERENT MILLING DRUM SPEED OPTIONS

An intelligent feature assists the machine operator in optimizing diesel consumption, milling performance and thus the overall efficiency of the W 200 Hi: adjustment of the milling drum speed from the operator's platform. It guarantees optimum milling performance regardless of requirements and across a wide range of applications.

When carrying out standard milling jobs, such as milling off a surface course, the W 200 Hi usually operates at the medium milling drum speed. The high speed is selected for the large-scale milling of thin pavement layers at high advance rates. Low speed is the right choice if maximum milling performance levels are to be achieved at the lowest possible cost: it guarantees reduced fuel consumption rates and low cutting tool wear.

DIFFERENT MILLING DRUM SPEEDS FOR SPECIFIC MILLING JOBS

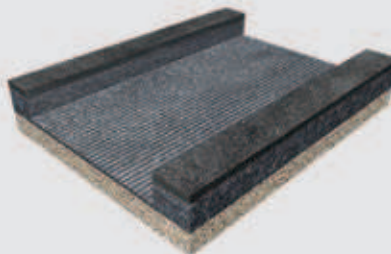

Low speed: complete removal at full depth

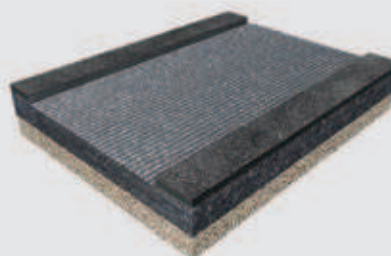

Medium speed: milling off surface courses, thin road pavements etc.

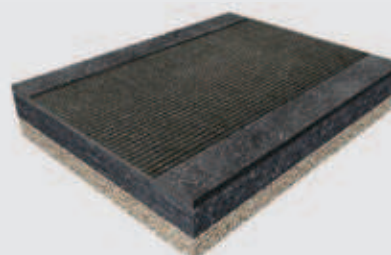

High speed: fine milling





WIRTGEN

Wide range of applications –

full control.

W 200 Hi

ALL IS SET TO GO, WAITING FOR YOUR COMMAND. VARIOUS AUTOMATED FUNCTIONS ARE CONTROLLED VIA SEPARATE CONTROL PANELS. ERGONOMIC DESIGN, CLARITY AND SIMPLICITY DETERMINE THE OPERATOR'S PLATFORM OF THE W 200 Hi. ALLOWING YOU TO FULLY FOCUS ON WHAT'S REALLY IMPORTANT: TOP PERFORMANCE AND TOP-QUALITY WORK RESULTS.



Gaining control quickly

EFFORTLESS CONTROL INCREASES PERFORMANCE AND PRODUCTIVITY

Simplicity is the guiding principle applied to the operation of the W 200 Hi. The number of controls is small as the WIDRIVE machine management system takes care of many tasks previously performed by the operator. The clearly arranged controls are labelled in a language-neutral manner, fit right into the palm of the operator's hand and help to prevent fatigue during work.

External panels can be used to operate the machine quickly and easily from the ground. In addition, the clearly structured colour control screen continuously informs the operator of important machine and operating parameters while innovative, user-friendly diagnostic tools ensure easy operation. As a result, he will be able to operate the W 200 Hi effortlessly and intuitively after only a short training period.



1-2 | The workplace is equipped with two functionally identical control panels left and right.

3 | Display screens providing current information keep the operator up to date.

Giving operators the full picture - at all times

JOB PARAMETERS AND CAMERA IMAGES AT A GLANCE

The multifunctional control screen provides clear information on operational parameters and maintenance details. User-friendly diagnostic tools with clear illustrations ensure the transparency of diagnostic procedures. Continuous logging of events during the milling process is yet another useful feature. In addition, the control system displays information such as the weight and volume of the material milled, size of the milled area or number of trucks loaded automatically after manual entry of the material density and milling width. These job data enable easy logging of daily production rates.

The control screen can be switched to camera mode to monitor important work processes. Two or six cameras with high-resolution colour screens can be installed in accordance with customer specifications. When using six cameras, an additional camera screen is installed to allow two camera views to be displayed simultaneously.

The WIRTGEN WITOS FleetView telematics system supports fleet management, machine position and status monitoring, as well as maintenance and diagnostic procedures. In short: it is yet another key driver for improved efficiency in day-to-day operation.

OVERVIEW OF CAMERAS:

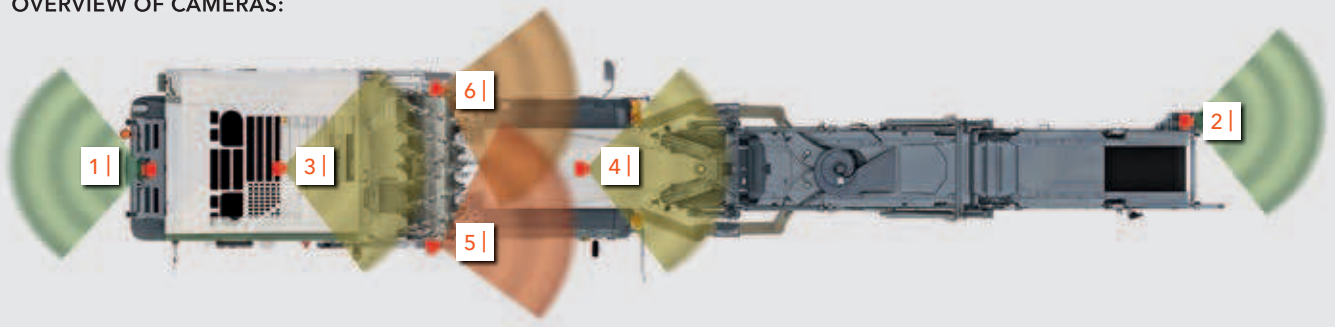

1 | Camera at the rear



2 | Camera at end of conveyor



3 | Camera at scraper



4 | Camera front, centre



5 | Camera front, right



6 | Camera front, left



Operating parameters:



Job data:



Diagnostics of milling drum unit:

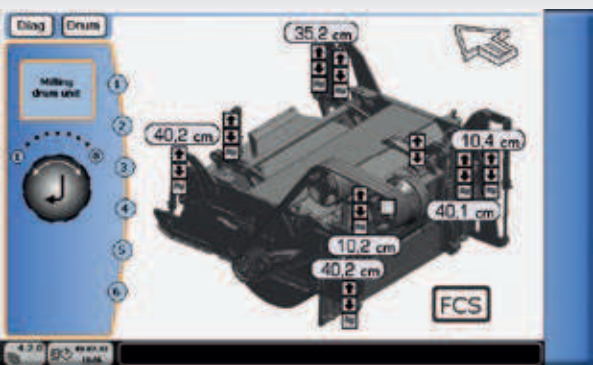

Diagnostics of height adjustment:

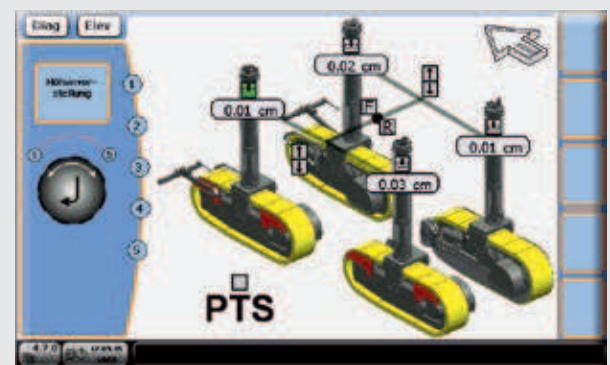

Fully focused on the milling job

Ergonomic working and perfect visibility in upright and seated position, adjustable control panels, individually adjustable comfort seats.



PERFECT VIEWING ANGLES

The W 200 Hi offers an ingenious visibility concept to support one-man operation: the extra slender design of the front machine frame and recessed wasp waist on both sides give the operator a full view both of the front track unit and the milling edge. The control panels can be adjusted individually to suit the operator's personal preferences, making sure he does not lose sight of the controls. Yet another highlight: the height-adjustable seat can be moved toward the control panel and beyond the edge of the machine by means of a swivel arm.

Wasp waist design for perfect visibility from the anti-vibration mounted operator's platform; the railing can be moved to the outside.

Altogether, the versatile range of user-specific adjustment options provide the operator with a perfect viewing level and position both when seated and when standing. The fully vibration-isolated operator's platform and anti-vibration mounted engine minimize the impact of vibrations on the operator.

Depending on weather and site conditions, the canopy can be extended independently on the left and right.



LEVEL PRO - on the road to success with a unique levelling system

WIDE RANGE OF LEVELLING SENSORS

WIRTGEN has developed an ultra-precise proprietary levelling system that includes a software programmed specifically for cold milling machines - LEVEL PRO. The overall system comprises the clearly structured LEVEL PRO panel, a controller and multiple sensors. A wide variety of different sensors, such as milling depth, cross slope or ultrasonic sensors, can be integrated into the automatic levelling system. The graphics-enabled LEVEL PRO panel provides a clear readout of key parameters. For example, the set and actual values of two active sensor signals and one passive sensor are continuously displayed on the screens as work progresses. An additional milling depth indicator on the screen - showing the difference between scraper blade and side plate positions - enables convenient monitoring of the actual milling depth. In addition, the memory feature is extremely useful to pre-programme, store and retrieve set values.



LEVEL PRO SCREEN

Automatic ON/OFF

Settings

Switchover button

Set value

Set value UP/DOWN

Actual value

Calibration

Controller output

Cylinder UP/DOWN

Memory 1

Memory 2





Efficiency counts.



NEEDLESS TO SAY THAT PERFORMANCE IS IMPORTANT. JUST AS IMPORTANT AS ECONOMIC EFFICIENCY. THAT IS WHY WE HAVE EQUIPPED THE W 200 Hi WITH A POWERFUL, ECONOMICAL DIESEL ENGINE. ITS EFFICIENCY IS PROMOTED FURTHER BY STATE-OF-THE-ART TECHNOLOGIES. TECHNOLOGIES SUCH AS THE INNOVATIVE WIDRIVE MACHINE MANAGEMENT SYSTEM.

Performing the toughest jobs - saving on fuel

HIGH-PERFORMANCE ENGINE TECHNOLOGY AND OPTIMIZED ENVIRONMENTAL PROTECTION

The W 200 Hi features state-of-the-art engine technology for extremely low environmental emission levels, complying with the stringent specifications of exhaust emission standards EC Stage 4/US Tier 4f.

The W 200 Hi is equipped with a powerful, economical ECO diesel engine. Thanks to the fully electronic WIDRIVE machine management system, the engine always works in the optimal performance and torque ranges, at extremely low fuel consumption rates and low operating costs.

To ensure effective exhaust gas purification, the engine installed in the W 200 Hi is fitted with both a combined two-way catalytic converter and diesel particulate filter as well as an SCR catalytic converter. The WIDRIVE machine management system guarantees consistently high performance levels even under full load. Operating costs of the W 200 Hi are reduced further by the machine's intelligent diesel engine control.

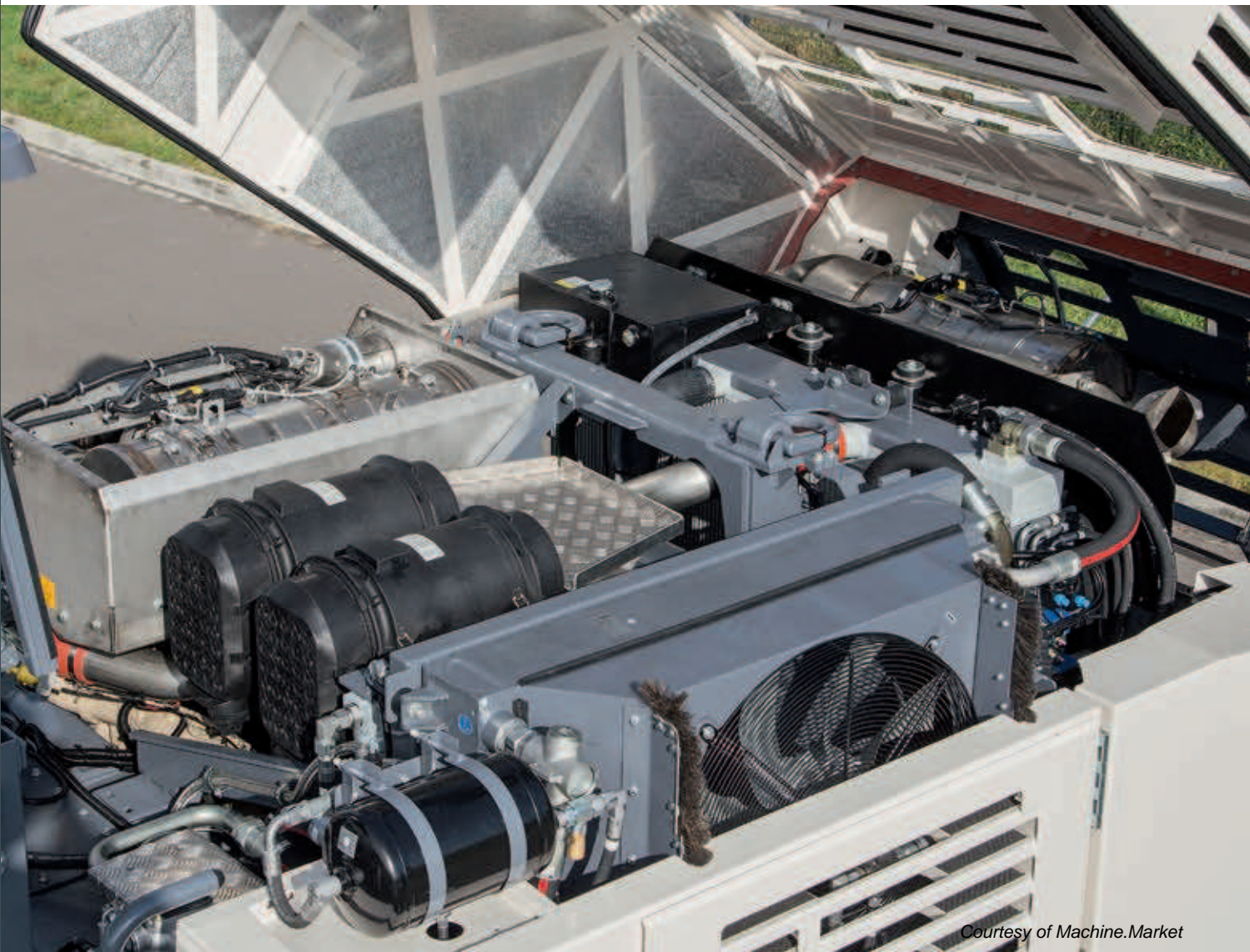

W 200 Hi ENGINE CHARACTERISTICS

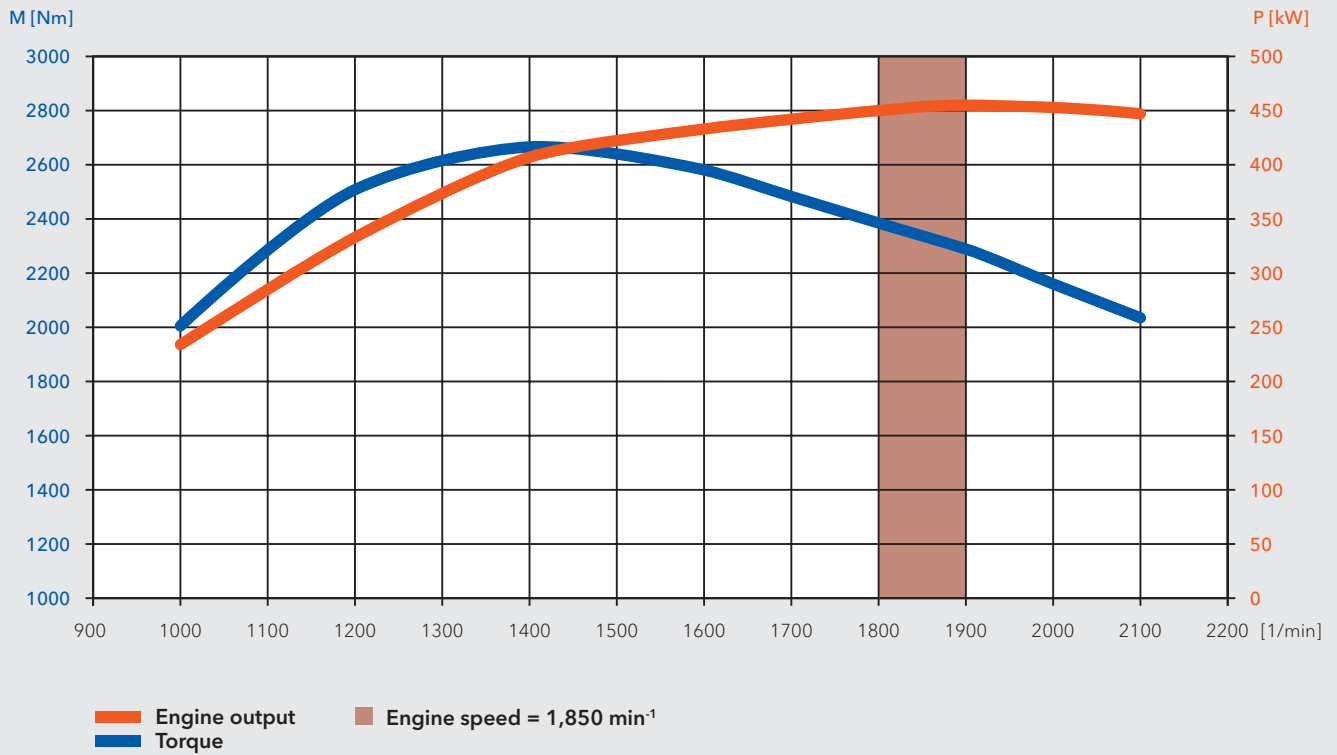





Superior manoeuvrability

for the complex milling jobs.

CHALLENGING EVERYDAY ROUTINE ON THE MILLING SITE: QUICK TURNING MANOEUVRES IN RESTRICTED SPACE CONDITIONS. SMALL MILLING RADII. MILLING AND MANOEUVRING ON DIFFICULT GROUND. ROUTINE OPERATIONS FOR THE W 200 Hi. INNOVATIVE WIRTGEN TECHNOLOGIES PUT YOUR COMMANDS INTO ACTION WITH PINPOINT PRECISION. ADD TO THIS THE ALL-TRACK DRIVE DESIGNED WITH OPTIMUM TRACTION IN MIND. PERFECTION RIGHT DOWN TO THE SMALLEST DETAIL.



The four track units feature large steering angles to enable amazingly small turning circles.

ISC – gaining ground quickly

SMALL RADII AND PRECISE STEERING MANOEUVRES

Crab steering permits the machine to easily approach the milled cut from the side.

Regardless of whether the machine is manoeuvring or is milling in narrow bends, in roundabouts or on roads in urban areas: the

compact W 200 Hi enables even small radii to be milled to maximum precision.

But this is attributable not only to the hydraulic all-track steering system, freely selectable steering modes, track units with separate hydraulic height adjustment or continuously adjustable travel speed. Add to this the intelligent ISC (Intelligent Speed Control) track control system. It includes three basic features: electronic traction control system, automatic speed adjustment of the individual track units in bends and optimized advance rate.



PTS - intelligent machines will drive the future

MAXIMUM MACHINE STABILITY

The proprietary PTS system guarantees full compliance with the specified working depth while at the same time relieving the operator of a significant part of his workload. PTS is short for "Parallel To Surface", meaning that the system aligns the machine parallel to the road surface automatically in a dynamic process: the front and rear lifting columns are lowered evenly and in a parallel movement. In addition, the four-fold full-floating axle that forms part of the PTS system quickly levels out any irregularities on both machine sides.

Overall, PTS significantly reduces the number of operator interventions previously generated by the need for manual adjustments.

The cold milling machine aligns parallel to the pavement surface automatically.

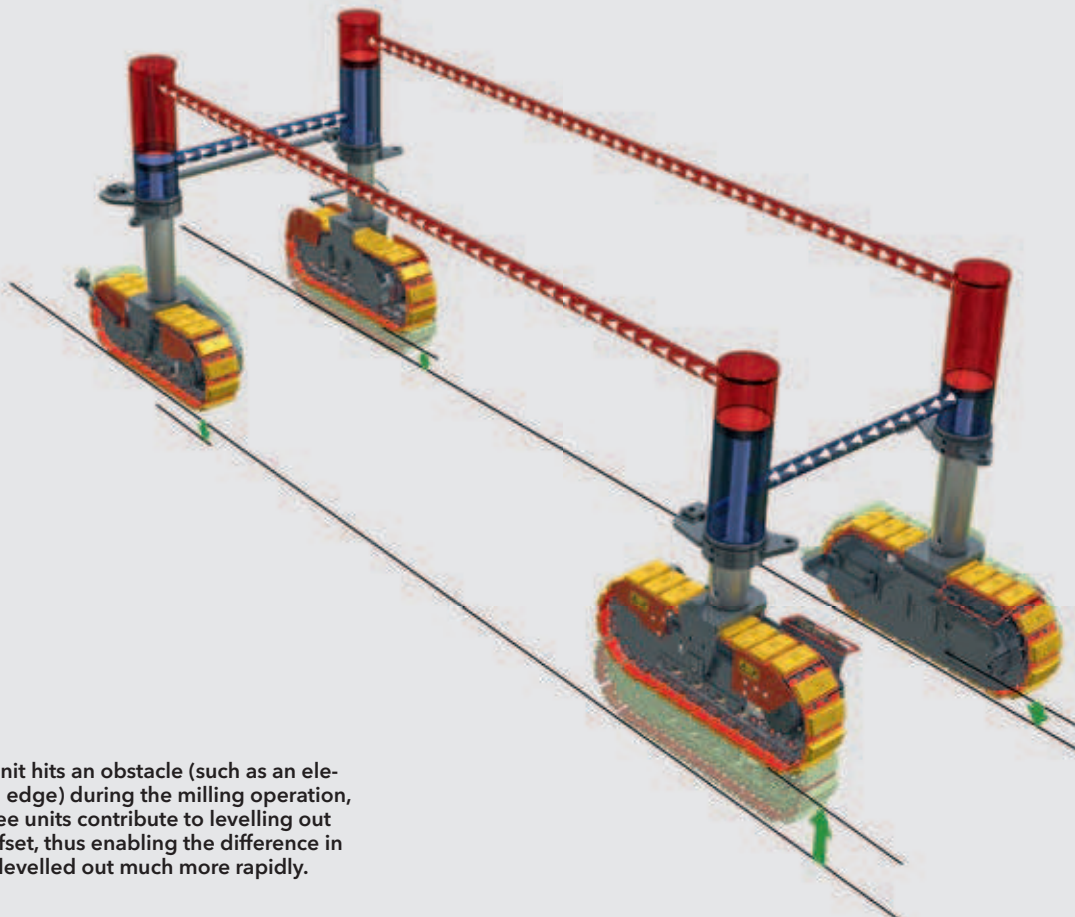

If one track unit hits an obstacle (such as an elevated milling edge) during the milling operation, the other three units contribute to levelling out the height offset, thus enabling the difference in height to be levelled out much more rapidly.

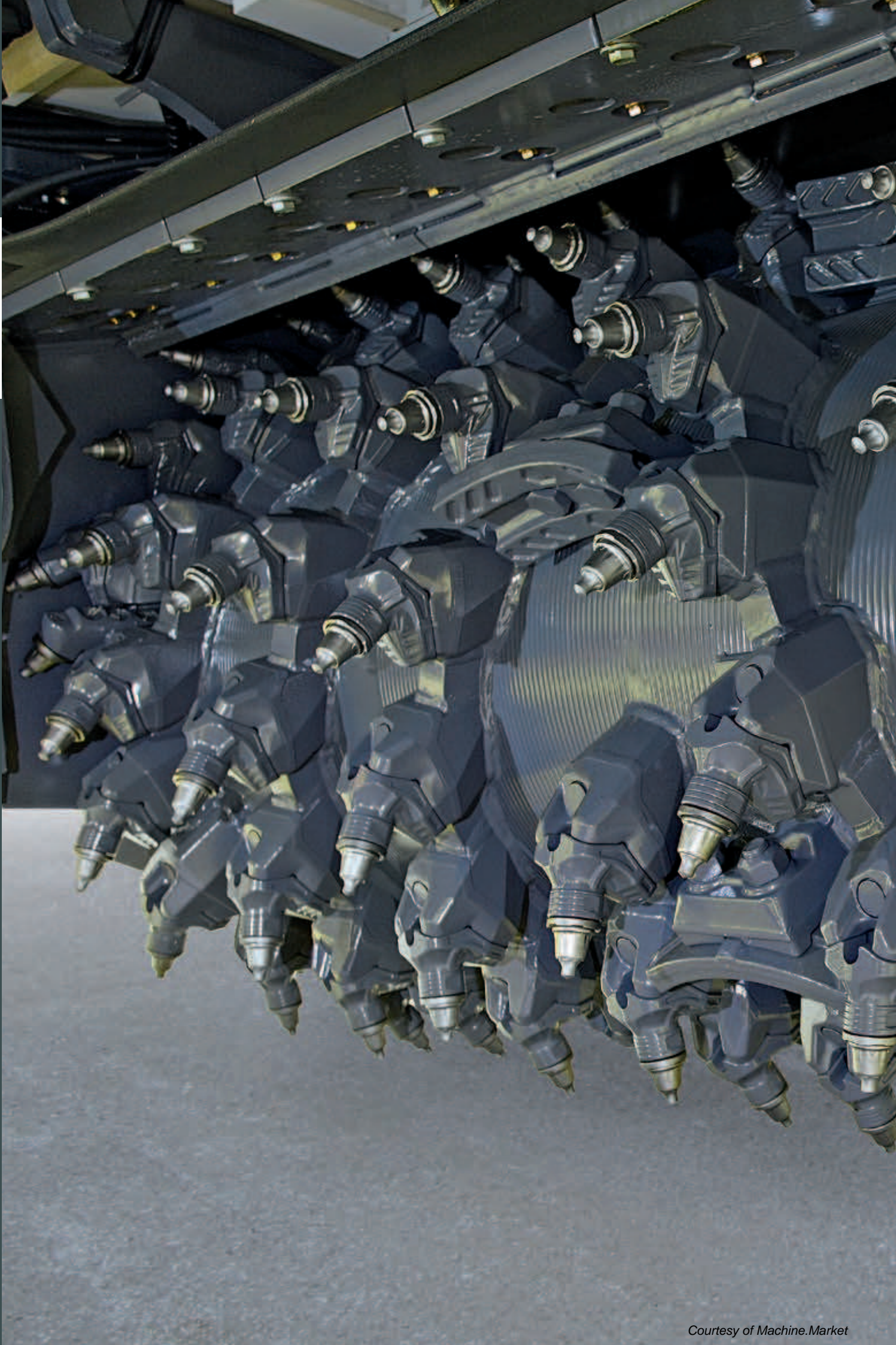

A close-up, high-angle photograph of a milling drum unit. The drum is a large, cylindrical metal component with a series of longitudinal ridges. It is densely packed with numerous cutting tools, which appear to be carbide end mills or similar milling cutters. The tools are arranged in a regular pattern along the length of the drum. The lighting is dramatic, highlighting the metallic surfaces and the sharp edges of the cutting tools. The background is dark, making the metallic components stand out.

Leading in milling expertise.

PERFECTLY ENGINEERED CUTTING TECHNOLOGY MADE BY WIRTGEN. BROUGHT TOGETHER IN THE MILLING DRUM UNIT OF THE W 200 Hi. FOR RELIABLE, HARD-WEARING OPERATION. PAIRED WITH SUPERIOR FUNCTIONALITY: ZERO-CLEARANCE SIDES ON THE LEFT AND ON THE RIGHT - TO COMPLETE COMPLEX MILLING JOBS EVEN MORE EFFICIENTLY THAN STANDARD COLD MILLING MACHINES. IN OTHER WORDS: THE W 200 Hi SETS THE BENCHMARK.

HT22 for increased profitability on the job site

LONG SERVICE LIFE IN EVEN THE TOUGHEST JOBS

The electrohydraulically operated tool extractor improves the machine's overall productivity.

The heavy-duty HT22 quick-change tool-holder system minimizes breaks in operation as it has been designed for tough operating conditions.

This is ensured by the use of exceptionally wear-resistant materials, perfect tool rotation and easy tool replacement - to name just a few of its many advantages. Cutting tool replacement can be facilitated further by means of a hydraulic drum turning device and an additional seat mounted between the rear track units.

The cutting tools are replaced using either standard manual or pneumatic extractors or - to optimize the process - an electrohydraulic tool extractor which extracts the tools effortlessly with the engine switched off.



HT22 QUICK-CHANGE TOOLHOLDER SYSTEM IN DETAIL

- 1 | Extremely large maximum wear distance
- 2 | Wear markers at 5 mm intervals
- 3 | High wear volume
- 4 | Optimized shank angle geometry for high component strength
- 5 | Large shank cross-section for significantly higher fracture strength
- 6 | Protective plug prevents soiling of bolt head
- 7 | Heavy-duty retaining bolt
- 8 | Seal between upper part and bottom part to allow simple insertion/removal of upper part
- 9 | Upper part covers bottom part completely for full protection of bottom part
- 10 | Extra large contact surface between upper part and bottom part for extended bottom part life
- 11 | Optimized welded connection offering increased strength and simultaneous flexibility for optimum tool rotation

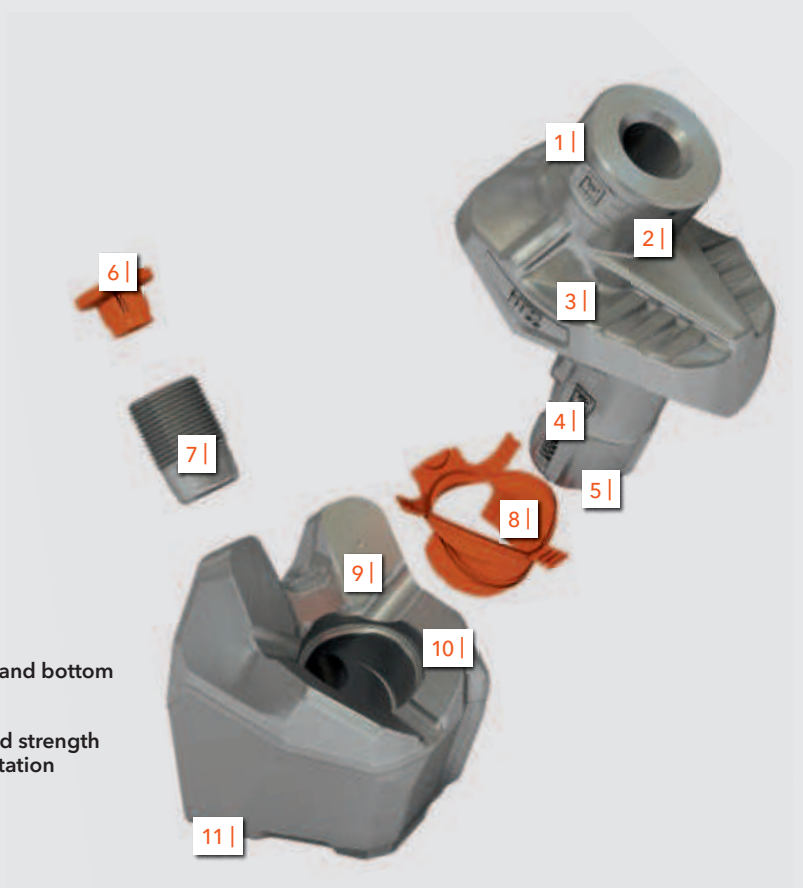

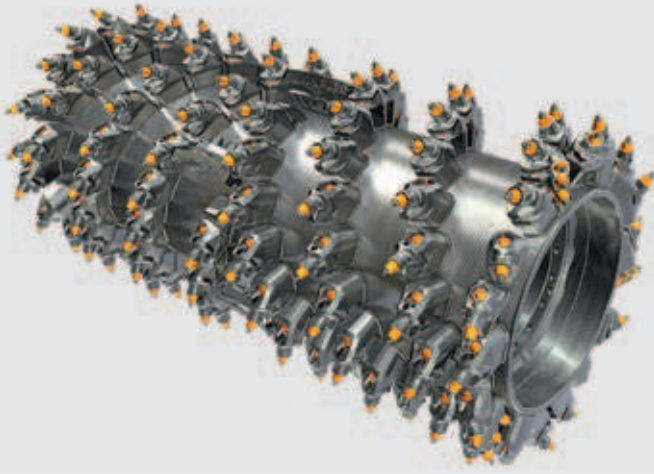

Standard milling drum

Milling width: 2,100 mm
Milling depth: 0 to 300 mm
Tool spacing: 15 mm

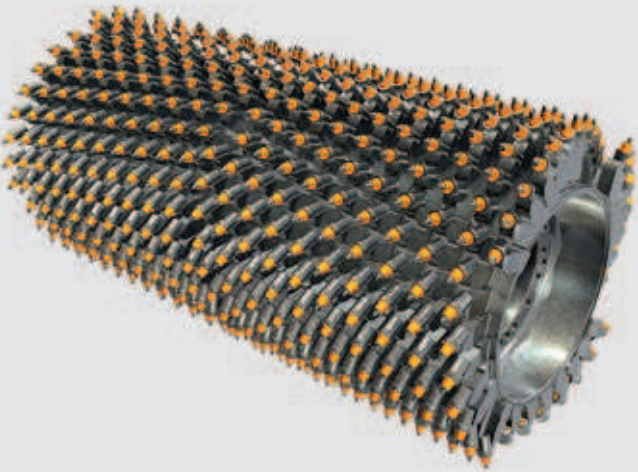

Fine milling drum

Milling width: 2,100 mm
Milling depth: 0 to 30 mm
Tool spacing: 6x2 mm

Milling width of 2.1 m, milling depth of up to 300 mm

WIDE RANGE OF APPLICATIONS

The W 200 Hi can alternatively be equipped with a standard milling drum or a fine milling drum, both of which have a working width of 2.1 m and are interchangeable.

Standard milling drums are eminently suitable both for milling individual pavement layers and for removing complete pavement structures comprising surface, binder and base layers at full depth.

In addition, they create a good interlock on the milled surface. Fine milling drums create finely textured surfaces ideally suited as a base for the application of thin pavement layers. They can also be used to level surface irregularities, roughen pavements, improve skid resistance and surface evenness or remove coatings.

Its wide range of applications ensures optimum utilization of the W 200 Hi, making it a highly profitable machine.



Always mill with the flow of traffic thanks to two zero-clearance sides

DUAL FLUSH-TO-KERB MILLING

The W 200 Hi large milling machine features a zero-clearance side not only on the right but also on the left side, enabling it to mill right up close along obstacles such as safety barriers, kerbs or building walls. The W 200 Hi plays this big trump card in particular on narrow roads where turning manoeuvres are not possible and the machine can move along with the flowing traffic only. Whether left or right - the large milling machine is capable of milling right up close to the road boundary on both machine sides.

A typical application: milling dual-lane roadways with safety barriers installed on both sides and traffic passing along on the adjacent lane. The W 200 Hi mills right up close to the safety barriers on the left and right even though it cannot turn around due to the lack of space. Trucks removing the milled material can pull out of and merge into the flowing traffic without having to perform dangerous turning manoeuvres.



Moving the milling drum unit to the right hydraulically enables the W 200 Hi to mill flush along the right-hand safety barrier while moving forward with the flow of traffic.



Moving the milling drum unit to the left then enables the W 200 Hi to mill right up close to the traffic cones on the left side of the machine without requiring any turning manoeuvre.

In the next step of the operation, the left-hand traffic lane can be rehabilitated just as easily with the machine moving in the direction of traffic.

Milling drum unit can be moved by 800 mm

The milling drum unit can be moved by 400 mm each to the left and right.



KEY TO SUCCESS IN NARROW SECTIONS

The milling drum unit installed in the W 200 Hi can be moved by 400 mm each to the left and right hydraulically. The advantages are obvious: during the milling process, the machine operator can precisely adjust the course of the milling edge and simply mill around road fixtures such as manhole covers, storm drains, streetlamps or similar.

Depending on site conditions, the movable milling drum unit additionally enables accurate positioning of the track units right next to the milling edge.



Milling around obstacles poses no problem at all.

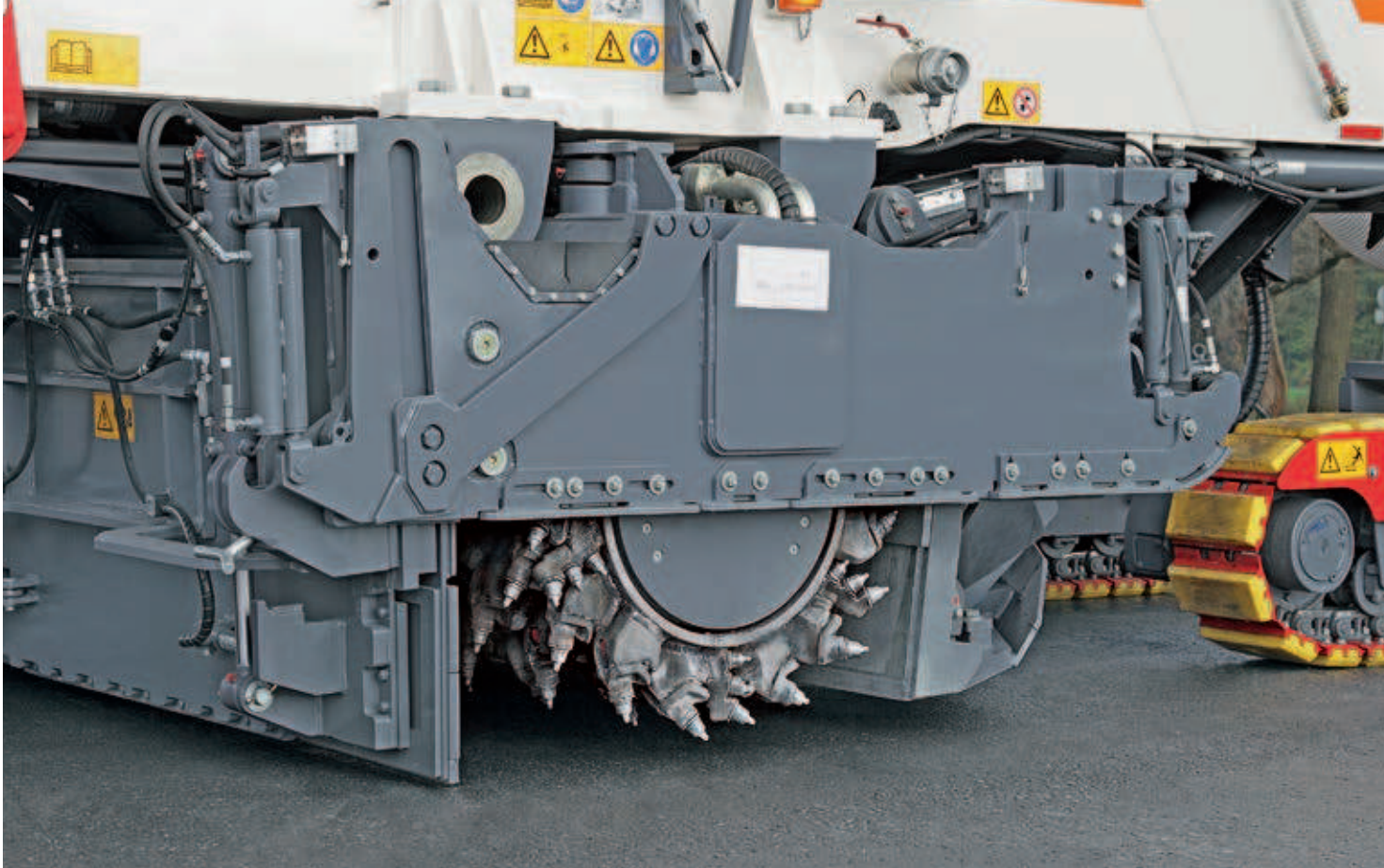

Flexible milling drum unit

INTELLIGENT DESIGN

The milling drum unit installed in the W 200 Hi offers an exceptionally high degree of flexibility. The hydraulically height-adjustable side plates left and right allow precise milling along road fixtures and can be raised by 420 mm each. Accurate milling flush to kerb is thus also possible at large working depths, enabling the side plates to move over the kerb for the purpose of level detection.

The scraper blade is raised and lowered hydraulically in order to load all or part of the milled material or to leave it behind in the milled cut. To prevent any collisions occurring during manoeuvring, the gradation control beam, scraper blade and side plates are moved into a protective position automatically together with the lifting columns.

Side-moving scraper elements on both sides enable the milling drum unit to be moved to the left and right even during the milling operation.

The side plates on the left and right can be raised by 420 mm each.

Dimensions in mm:





A yellow conveyor truck is shown in the process of dumping a large quantity of dark, milled material into a yellow trailer. The truck's conveyor system is extended, and the material is falling into the trailer. The background features a green field and utility poles under a clear blue sky.

In full control

of the loading operation.

PERFECTION IN EVERY SINGLE DETAIL IS NEEDED TO ENSURE PROPER FUNCTIONING OF THE WHOLE. A PRIME EXAMPLE OF THIS: THE CONVEYOR SYSTEM INSTALLED IN THE W 200 Hi. THE HIGH-PERFORMANCE LOADING CONVEYOR CLEARS AWAY MANY TONNES OF MILLED MATERIAL EVEN IN COMPLEX OPERATING SITUATIONS. ALWAYS FLEXIBLE, ALWAYS RELIABLE. ALWAYS PRECISE, ALWAYS EFFICIENT.

Maximum loading performance

1 | Extremely wide slewing angles of 60° each to the left and right for highest flexibility during material loading.



2 | For quiet operation at night: clearly visible "Stop" and "Go" instructions given to the truck driver.





RELIABLE LOADING REGARDLESS OF THE WORKING SITUATION

The W 200 Hi is equipped with a powerful, technically mature conveyor system. This is proven by numerous useful features, such as the extremely large slewing angles, wide belts, height-adjustable gradation control beam and variable belt speed, which ensure a flexible response to any situation encountered on the job site.

And when there is no milling activity, the intelligent WIDRIVE machine management system intervenes to ensure cost-efficiency: conveyor operation is stopped automatically when reversing and in transport mode. In addition, the diesel engine switches to idle speed in specific situations, for instance, when changing trucks during the milling operation or when stopping the machine's traction drive.

Continuously adjustable belt speed and discharge range.

-  High belt speed
-  Low belt speed



VCS - Vacuum Cutting System offers a perfect working environment

A CLEAN JOB

When designing the W 200 Hi, particular importance was placed on the health and well-being of the operating crew. As a result, the cold milling machine can be fitted with the Vacuum Cutting System to extract fine material particles. Its principle is simple: by creating a negative pressure in the drum housing, the mix of air and water vapour is evacuated from the housing and then fed back into the stream of the milled material on the discharge conveyor via a hose system. It goes without saying that better air quality and visibility in the working environment of the machine operator and ground crew significantly improve operator comfort and boost staff performance.

Reduced contamination of components such as the engine or air filter results in savings in the replacement of spare parts. The extraction system pays off quickly also because less effort needs to be put into cleaning the machine.



The centrifugal fan draws in the fine particles via hoses fitted on the side of the machine.

VCS ensures a perfect view of the milling edge regardless of the time of day or night.

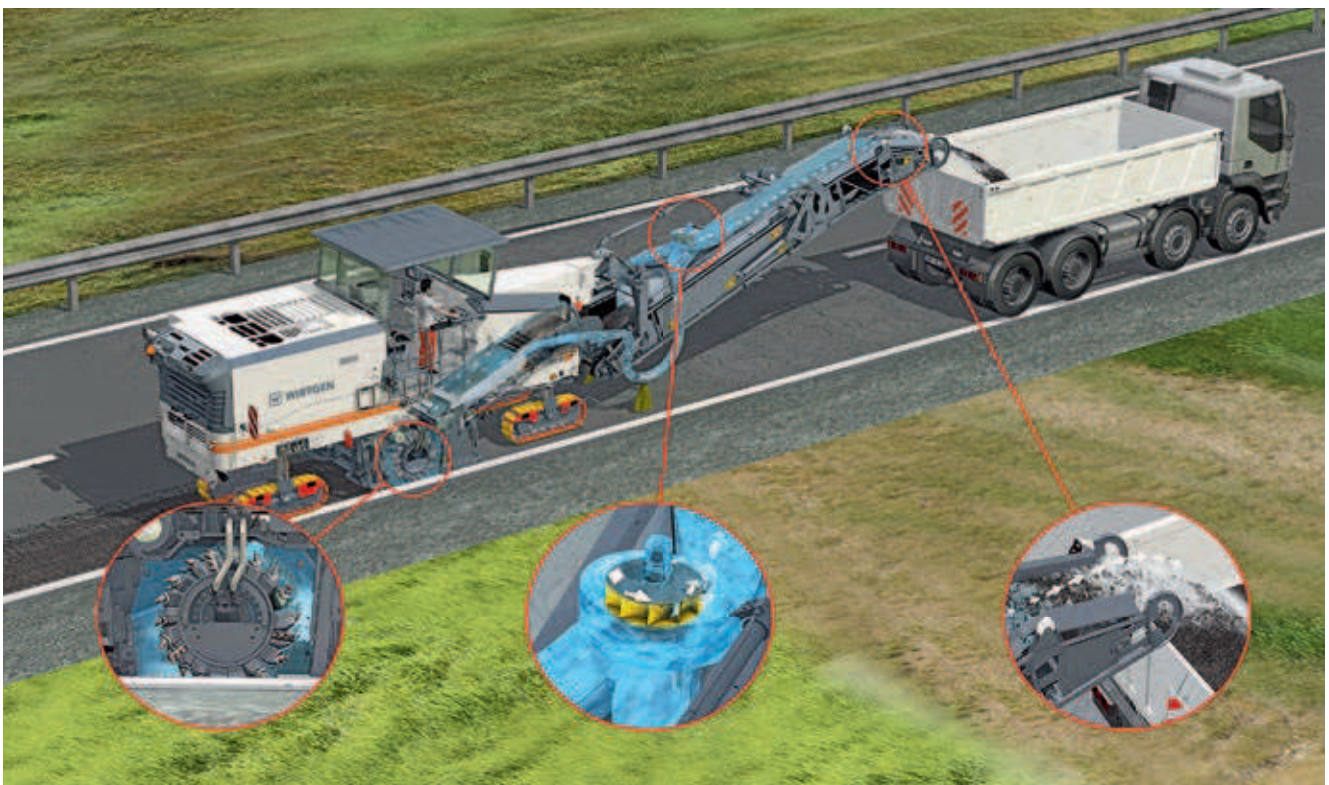



A worker in a yellow safety suit and hard hat is operating a large cold milling machine at night. The machine is processing a road surface, creating a long, straight path of milled material. The scene is illuminated by the machine's lights and the distant streetlights of a road under construction.

Operational

readiness guaranteed.

MACHINE COMPONENTS OF HEAVY-DUTY DESIGN. EASE OF TRANSPORT. EFFECTIVE LIGHTING SYSTEM. EASE OF MAINTENANCE INCLUDING EXTENDED SERVICE INTERVALS. WE HAVE MADE IT OUR TOP PRIORITY TO ENSURE THE OPERATIONAL AVAILABILITY OF YOUR COLD MILLING MACHINE ON A DAILY BASIS. SO THAT TOMORROW WILL BE YET ANOTHER SUCCESSFUL WORKING DAY WITH YOUR W 200 Hi.



The engine cowling opens hydraulically at the mere push of a button.

Quick maintenance boosts productivity

FOR PEACE OF MIND IN OPERATION

The hydraulically opening, hinged engine cowling and wide-opening service panels on either side ensure full access to all components requiring maintenance. All points of maintenance have been grouped together

and are arranged in a clear pattern, offering convenient access. The machine's automatic diagnostic system autonomously monitors valves, sensors and control components. Ample space is available for storing spare cutting tools, tool kit, machine equipment and high-pressure cleaner.

Excellent lighting enables night operations to be completed quickly and efficiently.

SUCCESSFUL MOVES IN NIGHT OPERATION

The lighting system includes several working lights and LED lamps offering flexible adjustment options to fully illuminate the important work areas. In addition, backlit control panels enable the machine operator to easily control the W 200 Hi even at night.



Moving on to the next job in no time

TRANSPORT HEIGHT OF 2.9 METRES ONLY

Transport of the W 200 Hi is easy, making sure that the machine will be ready for operation again quickly on the next job location. The conveyor in folding design reduces the machine's overall transport length and permits the use of smaller transport vehicles.

The canopy can be lowered hydraulically for transport. The machine has a transport height of only 2.9 metres. Removable supplementary weights enable the W 200 Hi to be transported on vehicles with a low maximum permissible payload.

Strong loading and lashing lugs enable the machine to be safely lashed down on a trailer or loaded by crane. Our range of equipment options includes conveyor support legs for machine transport on a flatbed truck.

1 | The folding conveyor reduces the machine's transport length.

2 | Transport on a flatbed truck with the canopy folded down - tailored to accurate fit!





PERFECT VISIBILITY, LOW NOISE LEVELS AND LOW FUEL CONSUMPTION ARE PROOF OF THE HIGH LEVEL OF ENVIRONMENTAL AWARENESS INVOLVED IN THE DEVELOPMENT OF THE WIRTGEN W 200 Hi. THE LARGE MILLING MACHINE REDUCES THE IMPACT ON THE ENVIRONMENT SIGNIFICANTLY WITH ITS INTELLIGENT WIDRIVE MACHINE MANAGEMENT SYSTEM, INNOVATIVE VCS DUST EXTRACTION SYSTEM AND ENVIRONMENTALLY FRIENDLY MACHINE TECHNOLOGY.

**Positive environmental
balance sheet.**



Technical specification

Milling drum	
Milling width standard	2,100 mm
Milling width *1	0-300 mm
Drum diameter with tools	900 mm
Engine	
Manufacturer	CUMMINS
Type	QSX15
Cooling	water
Number of cylinders	6
Rated power at 2,100 min ⁻¹	447 kW/600 HP/608 PS
Maximum power at 1,900 min ⁻¹	455 kW/610 HP/619 PS
Displacement	15 l
Fuel consumption at rated power	116 l/h
Fuel consumption in field mix	46 l/h
Emission standards	EU Stage 4/US Tier 4f
Electrical system	
Electrical power supply	24 V
Tank capacities	
Fuel tank	830 l
AdBlue®/DEF tank	70 l
Hydraulic oil tank	400 l
Water tank	3,000 l
Driving properties	
Max. travel and milling speed	0-85 m/min (5 km/h)
Track units	
Track units, front and rear (L x W x H)	1,630 x 260 x 590 mm
Loading of the milled material	
Belt width of primary conveyor	800 mm
Belt width of discharge conveyor	850 mm
Theoretical capacity of discharge conveyor	375 m ³ /h

*1 = The maximum milling depth may deviate from the value indicated due to tolerances and wear.

Weight of base machine	
Empty weight of machine excluding tank contents	27,800 kg
Operating weight, CE* ²	29,800 kg
Maximum operating weight (full tanks, full range of equipment) in FB2100	34,220 kg
Weights of tank contents	
Water tank filling	3,000 kg
Diesel tank filling (0.83 kg/l)	690 kg
AdBlue®/DEF tank filling (1.1 kg/l)	77 kg
Additional add-on weights	
Driver and tools	
Driver	75 kg
5 cutting tool containers	125 kg
On-board tools	30 kg
Optional milling drums in lieu of standard	
Milling drum FB2100 HT22 LA18 with 169 picks	- 325 kg
Optional additional equipment	
Operator's platform including comfortable seats in lieu of standard	250 kg
Canopy in lieu of standard	280 kg
Cabin in lieu of standard	570 kg
VCS - Vacuum Cutting System	220 kg
Supplementary weight	1,100 kg

*² = Weight of machine, half-full water tank, half-full fuel tank, driver (75 kg), on-board tools, excluding optional equipment features.

Dimensions

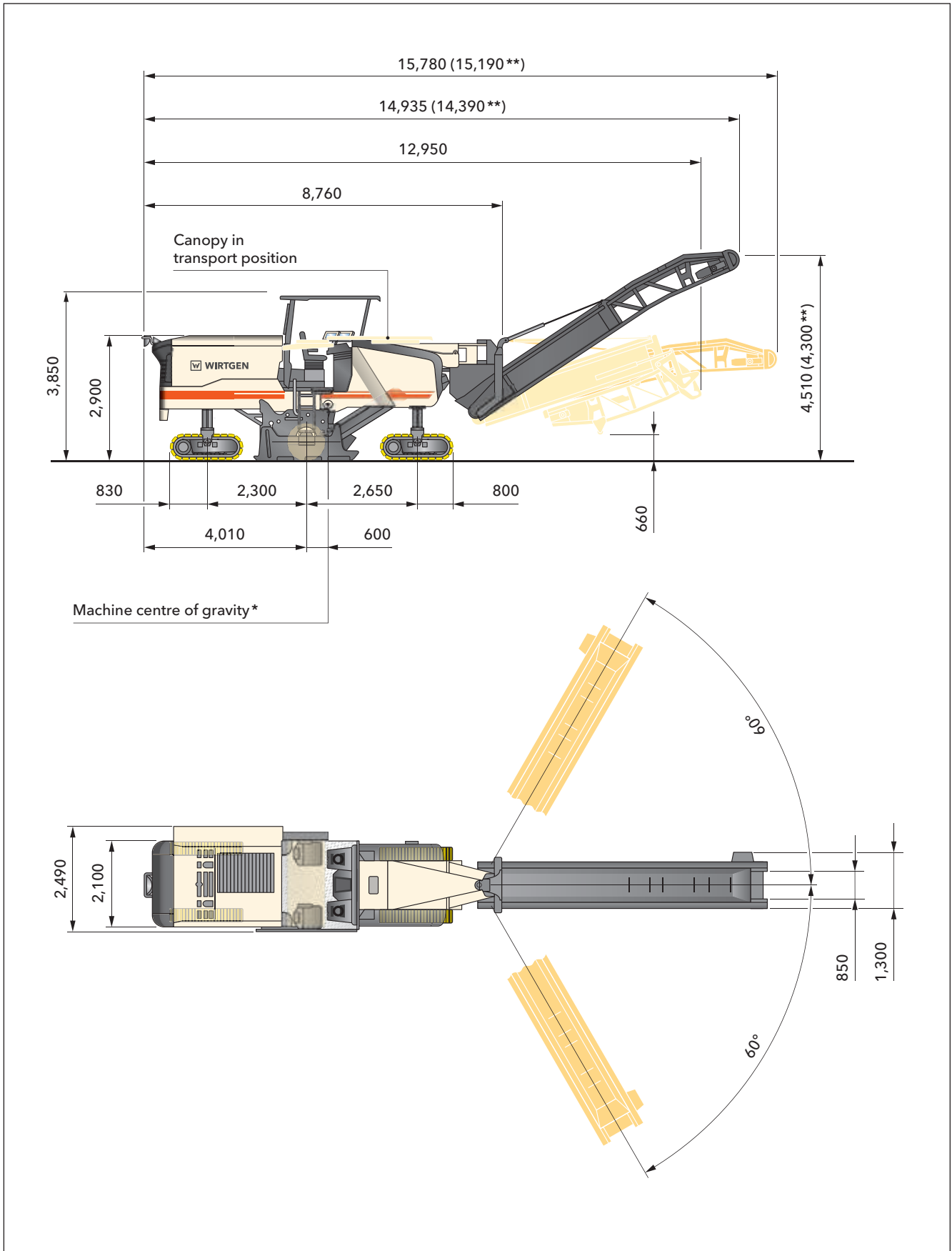

Dimensions in mm

* = based on operating weight, CE with conveyor folded out
 ** = based on machine with short conveyor

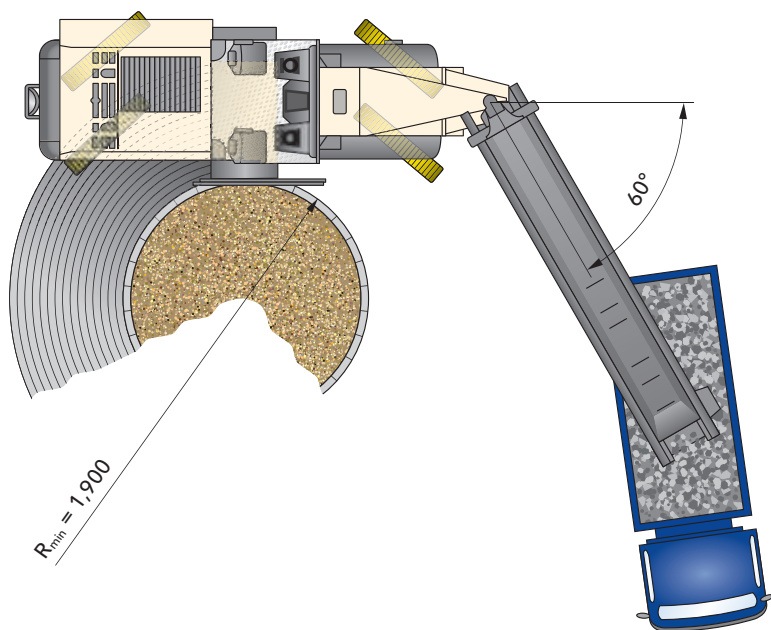
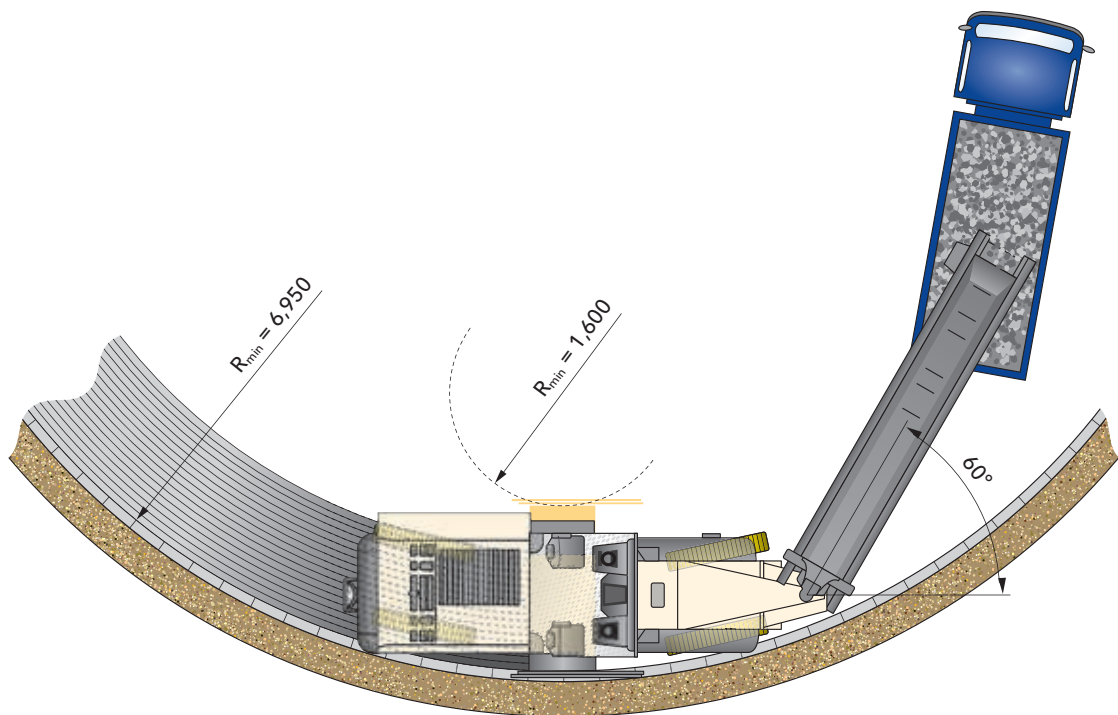

Milling radius, milling depth 150 mm, Dimensions in mm

Standard equipment

48
49

Base machine	
Basic machine with engine	■
Maschine chassis with double-sided wasp waist	■
Hydraulically opening engine cover with noise insulation	■
Air compressor system	■
Battery operated hydraulic unit for emergency functions	■
Cooling system with temperature-controlled fan speed	■
Storage compartments for pick buckets	■
Milling drum unit	
Milling drum housing FB2100	■
Milling drum housing with infinitely variable lateral shift function permits milling up to the edge on the right or left side of the machine. The total adjustment range is 800 mm. (400 mm left/400 mm right)	■
Hydrostatic drive of the milling drum	■
Three milling drum rotation speeds with electric on/off function	■
Hydraulic material depressor with conveyor lifting function	■
Hydraulically movable and positionable scraper plate	■
Hydraulically lifting side plate, clearance 420 mm right and left	■
Triple-divided water sprinkling strip in the milling drum unit, segments individually switchable	■
Milling drums	
Milling drum FB2100 HT22 LA15 with 190 picks	□
Milled-out material loading	
Conveyor belt system with manually or automatically controllable transport speed	■
Water sprinkling system in the primary conveyor	■
Slewing angle discharge conveyor ± 60°	■
Discharge conveyor, 7,900 mm long, 850 mm wide	□
Machine control and levelling system	
Multi-function control display showing important machine operating conditions	■
Extensive machine diagnosis in the control display	■
Milling power control with automatic on/off function	■
Two exterior panels for operating functions by ground personnel	■
Milling depth regulation with LEVEL PRO levelling system, with one operating display as well as one electrical height sensor in the hydraulic cylinder right and left on side plate	■

- = Standard equipment
- ▣ = Standard equipment, replaceable with optional equipment
- = Optional equipment

Operator's stand	
Operator's stand with complete flexible mounting	■
Convenient, individually adjustable operating panel	■
Convenient footstep to the operator's stand, right and left	■
Covers for operating panels with lock	■
Two mirrors front and one mirror in rear area of the machine	■
Operator's stand with single standing seats	□
Exterior mirror standard	□
Under-carriage and height adjustment	
PTS - machine automatically guided parallel with the road surface	■
ISC - intelligent track speed control with hydraulic four chain drive	■
High machine stability due to quadruple pendulum axle	■
Freely selectable steering functions for the four-track steering	■
Extremely wear-resistant, two-piece EPS polyurethane track pads	■
Others	
Lighting package with 5 halogen floodlights and 4 LED lights in the area of the milling unit	■
"Welcome" and "Go home" lights feature including LED lighting in the area of the operator's access and platform	■
Large tool package in lockable tool box	■
Total of 6 EMERGENCY STOP switches at sensible positions on the machine	■
Water high-pressure system with automatic on/off function, 18 bar, 67 l/min	■
Machine preparation for installing the control unit for WITOS FleetView. "WIRTGEN Road Technologies Telematics and on-site Solutions" (WITOS) is the intelligent telematics system of the WIRTGEN Road Technologies for efficient fleet and service management worldwide.	■
European type test certificate, GS mark and CE conformity	■
Water tank filling from rear of machine	□
Paint standard cream white RAL 9001	□
Halogen lighting package 24 V with rotary beacons	□

■ = Standard equipment
 ■ = Standard equipment, replaceable with optional equipment
 □ = Optional equipment

Optional equipment

Milling drum unit	
Transport carriage for FCS milling drums from FB2000 to FB2200	<input type="checkbox"/>
Milling drums	
Milling drum FB2100 HT22 LA18 with 169 picks	<input type="checkbox"/>
Milled-out material loading	
Discharge conveyor, 7,900 mm long, 850 mm wide, with hydraulic folding device	<input type="checkbox"/>
Shortened discharge conveyor 7,300 mm long, 800 mm wide, with hydraulic folding device	<input type="checkbox"/>
VCS extraction system	<input type="checkbox"/>
Machine control and levelling system	
One ultrasonic sensor for scanning in front of the milling drum right or left	<input type="checkbox"/>
Two ultrasonic sensors for scanning in front of the milling drum right + left	<input type="checkbox"/>
One Sonic-Ski sensor for scanning in front of the milling drum right or left	<input type="checkbox"/>
Two Sonic-Ski sensors for scanning in front of the milling drum right + left	<input type="checkbox"/>
Operating display LEVEL PRO	<input type="checkbox"/>
Multiplex preliminary equipment comprising 4 sensor sockets	<input type="checkbox"/>
Multiplex 3-way right with 2 ultrasonic sensors, including Multiplex preliminary equipment	<input type="checkbox"/>
Multiplex 3-way right + left with 4 ultrasonic sensors, including Multiplex preliminary equipment	<input type="checkbox"/>
Basic equipment laser levelling without laser transmitter	<input type="checkbox"/>
Level control 3D levelling pre-equipment	<input type="checkbox"/>
Slope control sensor	<input type="checkbox"/>
Milling depth measurement and display in the LEVEL PRO display	<input type="checkbox"/>
Operator's stand	
Operator's stand with large storage compartment and single standing seats	<input type="checkbox"/>
Operator's stand with comfort seat package	<input type="checkbox"/>
Exterior mirror folding with signal lights	<input type="checkbox"/>
Weather canopy folds in electrohydraulically	<input type="checkbox"/>
Hot air heating footwell of the operator's stand	<input type="checkbox"/>
Monitor system with 2 cameras	<input type="checkbox"/>
Monitor system with 6 cameras and additional monitor	<input type="checkbox"/>

- = Standard equipment
- = Standard equipment, replaceable with optional equipment
- = Optional equipment

Others	
Water tank filling with hydraulic filling pump	<input type="checkbox"/>
Paint in one special colour (RAL)	<input type="checkbox"/>
Paint in two special colours (RAL)	<input type="checkbox"/>
Paint in maximum two special colours with substructure in special colour (RAL)	<input type="checkbox"/>
Powerful LED lighting package 24 V with rotary beacons	<input type="checkbox"/>
Additional weight 1100 kg	<input type="checkbox"/>
Large storage compartment on rear of machine	<input type="checkbox"/>
Electric preheating of the fuel filter	<input type="checkbox"/>
High-pressure water cleaner, 150 bar 15 l/min	<input type="checkbox"/>
Hydraulic pick ejector drift	<input type="checkbox"/>
Pneumatic hammer with pick ejector/insertor	<input type="checkbox"/>
Additional seats for pick change with storage compartment	<input type="checkbox"/>
Diesel tank filling pump with 5.0 m suction hose	<input type="checkbox"/>
WITOS FleetView telematics system incl. 3-year operating period (EU)	<input type="checkbox"/>
WITOS FleetView telematics system incl. 3-year operating period (USA)	<input type="checkbox"/>
WITOS FleetView telematics system incl. 3-year operating period - PROMOTION	<input type="checkbox"/>

= Standard equipment
 = Standard equipment, replaceable with optional equipment
 = Optional equipment



WIRTGEN GmbH
Reinhard-Wirtgen-Str. 2 · 53578 Windhagen · Germany
Phone: +49 (0)26 45/131-0 · Fax: +49 (0)26 45/131-392
Internet: www.wirtgen.com · E-Mail: info@wirtgen.com

