

Compact 2-m machine for efficient milling jobs.

# Cold Milling Machine W 200 / W 200i



# Outstanding features of the W 200/W 200i cold milling machine

02  
03

4 |

## MACHINE FRAME

- > **Perfect visibility**  
Slender machine frame design at the front including dual wasp waist for a perfect view of the milling edge.
- > **Ease of transport**  
Ease of transport due to low machine weight and variable supplementary weights of up to 1,700 kg.

3 |

## ENGINE STATION

- > **Three different milling drum speed options**  
Three selectable cutting speeds for optimum milling performance in a broad range of applications.
- > **Load-controlled fan speed**  
Fan speed governed by engine temperature for low energy consumption and low noise emission levels.

2 |

## ELECTRICAL SYSTEM

- > **Emergency operation**  
Electrohydraulic power pack to raise machine in emergency mode.
- > **Camera system**  
Robust camera system including up to six cameras and up to two screens.
- > **Job data**  
Precise recording of job data including "truck full" message.

1 |

## LEVELLING

- > **Large choice of sensors**  
LEVEL PRO automatic levelling system as standard equipment, offering a large choice of sensors and highly precise control of the milling depth.
- > **Milling depth indicator**  
Milling depth indicator on the LEVEL PRO screen (showing difference between scraper blade and side plate positions).
- > **Scanning in front of the milling drum**  
Scanning in front of the milling drum via hydraulic cylinders with integrated measuring system - suitable for use also with the Multiplex system.
- > **Automatic system to initiate the milling process**  
Automatic system to initiate the milling process with load-controlled lowering speed.

3 |

8 |



5 |

## OPERATOR'S PLATFORM

### > Multifunctional joystick

Multifunctional joystick with driving, steering, selecting operating mode, raising machine and switching off conveyor functions.

### > Ergonomics

Ergonomically designed, backlit controls for non-tiring, productive working.

### > Hydraulically moving and swivelling operator's cabin

Optionally available Operator Comfort System (OCS) for an ideal working environment.

### > Protective canopy

Fixed protective canopy with telescoping side panels for maximum protection from inclement weather.

### > Parallel alignment of machine

Automatic parallel alignment of the machine both during the milling operation and in transport mode.

6 |

## CONVEYOR SYSTEM

### > Large slewing angles

Conveyor slewing angles of 60° to both sides to optimize the loading process.

### > Tremendous conveying capacity

High conveyor loading capacity and drive power for highly efficient material loading.

### > Vacuum Cutting System

Vacuum Cutting System for improved visibility.

### > Folding conveyor with locking mechanism

Folding conveyor with intelligent mechanical locking mechanism for easy transport.

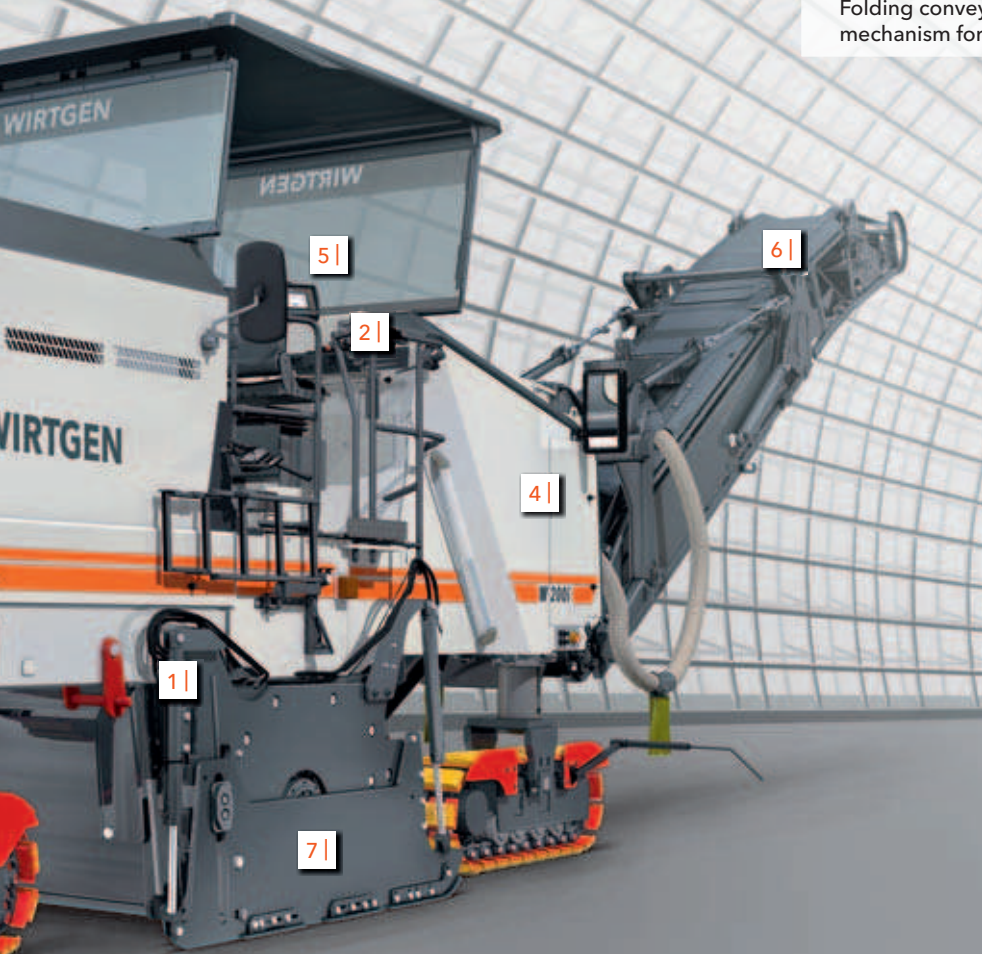

7 |

## MILLING DRUM UNIT

### > Locking of scraper blade

Automatic mechanical locking of scraper blade to ensure ease of operation.

### > FCS LIGHT

FCS Light for the quick replacement of milling drums in FB2000 and FB2200 milling drum units.

### > HT22 quick-change toolholder system

Extra efficient, tried-and-tested HT22 quick-change toolholder system as standard equipment.

### > Right-hand side plate lift of 450 mm

Right-hand side plate can be raised by up to 450 mm to allow flush-to-kerb milling at the full milling depth.

### > Load-controlled water spray system

Water spray system with automatic adjustment to the milling performance for optimum tool cooling.

### > Milling drum turning device

Drum turning device to enable cutting tool replacement with the diesel engine switched off.

8 |

## TRACTION DRIVE

### > Hydraulic pre-tensioning of track chains

Hydraulically pre-tensioned track chains for optimized operation.

### > Traction control

Intelligent electronic traction control system for the track units.

### > Track speed adjustment

Electronic adjustment of the track speed during cornering to ensure maximum traction and low wear and tear.

### > Four-fold full-floating axle

Four-fold full-floating axle for optimum machine stability.



A large white and orange Wirtgen cold milling machine is shown in operation on a road construction site. The machine's conveyor belt is raised, discharging a stream of dark material into the back of a white truck. The machine has 'WIRTGEN' and 'RMV' visible on its side. A worker in a blue uniform is visible in the operator's cab. The background shows a clear blue sky, green fields, and a line of trees. The road surface has some yellow and white markings.

**Efficiency**

**in the 2-metre class.**

**THE WIRTGEN W 200 / W 200i COLD MILLING MACHINE. FEATURING INNOVATIVE SOLUTIONS AND PIONEERING TECHNOLOGIES. PACKED WITH LOTS OF POTENTIAL IN COMPACT DESIGN FOR EFFECTIVE MILLING ON LARGE CONSTRUCTION PROJECTS. AND FOR A WIDE RANGE OF APPLICATIONS. THE W 200 / W 200i: GIVING A PROMISE OF SHORT CONSTRUCTION TIMES, TREMENDOUS EFFICIENCY AND HIGH PRODUCTIVITY. CALL ON IT TO DELIVER.**



*Low-emission, low-noise: the W 200/W 200i has been designed for environmentally friendly, economical operation.*

# Innovation drives efficiency to the max

## **EASY-TO-HANDLE, LIGHTWEIGHT LARGE MILLING MACHINE**

Whether your requirements include the extensive repair of surface courses, the removal of thin road pavements or fine milling activities of any type - the innovative WIRTGEN W 200/W 200i is your prime choice. The cold milling machine masters complex challenges using unique, novel technologies whilst achieving premium-quality milling results at an unbeatably low operating cost.

Further impressive features of the powerful W 200/W 200i include an ergonomically designed operator's platform and solid machine concept offering effective operation. Additional highlights include the tried-and-tested FCS Light, PTS automatic parallel alignment system, three adjustable milling drum speeds and efficient WIDRIVE machine management system.



1 | The W 200/  
W 200i clears  
construction sites  
easily thanks to its  
powerful conveyor  
system.

2 | State-of-the-  
art operation and  
control technology  
provides highest er-  
gonomic standards.



# Milling large surfaces with the multi-purpose W 200/W 200i

08  
09

## HIGH DAILY PRODUCTION RATES - WHATEVER THE JOB

Some tasks should be completed by seasoned specialists only. Quite clearly, the W 200/W 200i is one of them. Whether fine milling on a large scale, removing surface courses in a selective process, or performing

milling operations on space-restricted urban sites - the cold milling machine demonstrates the highest possible efficiency in all of these fields. Tremendous area performance levels can be achieved at low cost especially when performing fine milling operations on pavement surfaces.

Another factor contributing to the machine's economy is its wide range of applications enabling it to be utilized to full capacity at all times and on a wide variety of different construction projects.

Regardless of whether a milling drum unit with a working width of 1.5 m, 2.0 m or 2.2 m is used, the unrivalled milling depth enables the removal of complete pavements in a single pass.







# Increasing productivity the intelligent way

## SELECT THREE DIFFERENT MILLING DRUM SPEEDS

Another key innovation is the adjustable speed of the milling drum, which can be set from the operator's platform. It ensures perfect milling performance levels regardless of conditions and across a wide range of applications. A selector switch enables the milling drum to be set to three different speed levels.

The W 200/W 200i usually operates at the medium milling drum speed. The high speed is selected for large-scale fine milling operations at high advance rates. The low speed is selected to achieve maximum milling performance levels at reduced fuel consumption rates per cubic metre of milled material and low cutting tool wear and tear. To sum it all up, customers will quickly benefit from the excellent cost-benefit ratio at maximum productivity levels and high daily production rates.

## DIFFERENT MILLING DRUM SPEEDS FOR SPECIFIC MILLING JOBS

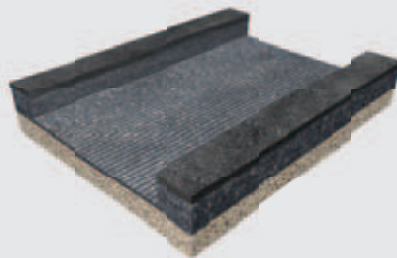

Low speed: complete  
removal at full depth

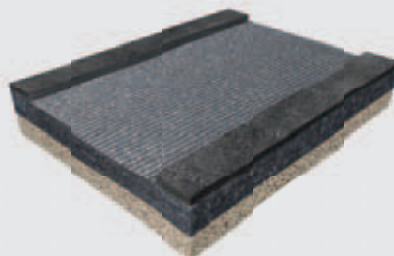

Medium speed:  
milling off surface courses,  
thin road pavements etc.

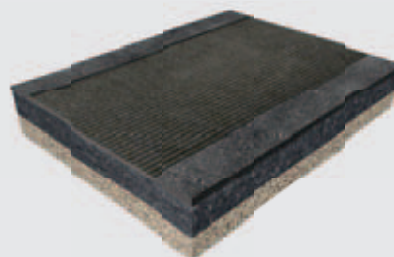

High speed:  
fine milling





# The benchmark in operation.

OFFERING AMPLE SPACE. INTUITIVE. FORWARD-THINKING. THE OPERATOR'S PLATFORM OF THE WIRTGEN W 200 / W 200i LARGE MILLING MACHINE SETS THE BENCHMARK IN CLARITY, ERGONOMIC DESIGN AND COMFORT. INNOVATIVE AUTOMATIC FEATURES ADDITIONALLY RELIEVE THE OPERATOR FROM PART OF HIS WORKLOAD. FULL CONTROL. FULL FOCUS ON THE MILLING PROCESS. SUCCESS GUARANTEED - WHATEVER THE JOB.



## Focus on what is really important

### **SMALL NUMBER OF BUTTONS AND SWITCHES**

Simplicity is the guiding principle applied to the operation of the W 200/W 200i. The number of controls is small, too, as the WIDRIVE machine management system takes care of many tasks that were previously performed by the operator. The clearly arranged controls are labelled in a language-neutral manner, enable perfect handling and help to prevent fatigue during work. In addition, the clearly structured colour control screen keeps the operator informed on important machine and operating parameters. As a result, the operator will be able to run the W 200/W 200i effortlessly and

intuitively after only a short training period. At the customer's request, the W 200/W 200i can be equipped with the Operator Comfort System (OCS) in lieu of the standard operator's platform. The hydraulically moving and swivelling cabin can be adjusted to the optimum position for the operator to have full visibility at all times. Camera transmission, precise joystick control and a powerful automatic climate control system provide a perfect working environment regardless of weather conditions.



1-2 | The workplace has been equipped with two identical control panels left and right.

3 | Optional OCS: the sound-insulated cabin offers good all-round visibility as well as weather protection and air-conditioned interior temperatures.

# Giving operators the full picture - at all times

## JOB PARAMETERS AND CAMERA IMAGES AT A GLANCE

The multifunctional control screen provides clear information on operational parameters and maintenance details. User-friendly diagnostic tools with clear illustrations ensure the transparency of diagnostic procedures. Continuous logging of events during the milling process is yet another useful feature. In addition, the control system displays information such as the weight and volume of the material milled, size of the milled area or number of trucks loaded automatically after manual entry of the material density and milling width. These job data enable easy logging of daily production rates.

The control screen can be switched to camera mode to monitor important work processes. Two or six cameras with high-resolution colour screens can be installed in accordance with customer specifications. When using six cameras, an additional camera screen is installed to allow two camera views to be displayed simultaneously.

The WIRTGEN WITOS FleetView telematics system supports fleet management, machine position and status monitoring, as well as maintenance and diagnostic procedures. In short: it is yet another key driver for improved efficiency in day-to-day operation.

### OVERVIEW OF CAMERAS:



1 | Camera at the rear



2 | Camera at end of conveyor



3 | Camera at scraper



4 | Camera front, centre



5 | Camera front, right



6 | Camera front, left



Operating parameters:



Job data:



Diagnostics of milling drum unit:

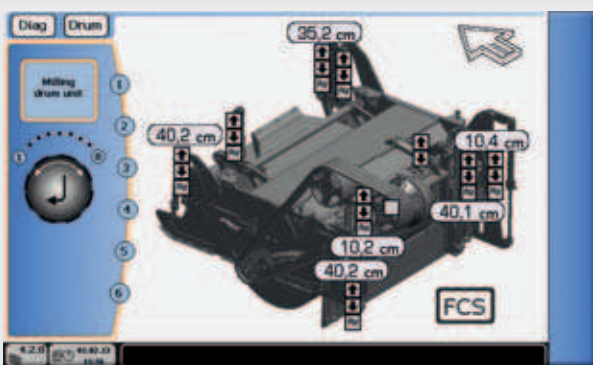

Diagnostics of height adjustment:

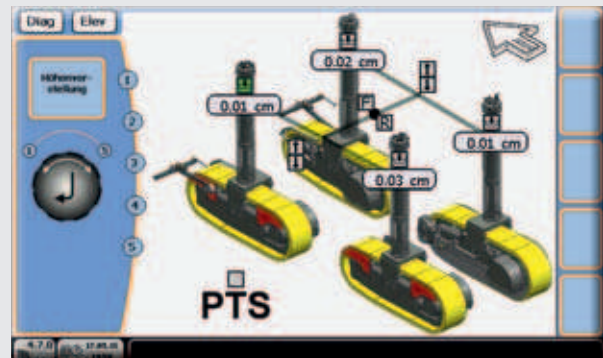

# Always right up close to the action

Whether working in upright or seated position: adjustable control panels, individually adjustable comfort seats.



## EXCELLENT VISIBILITY CONCEPT

Keeping an eye on both the milling edge and the track units all the time without losing sight of the controls. The design of the W 200/W 200i offers two features guaranteeing that this challenging requirement is met: first, the slender dual wasp waist design provides a perfect view of the milling operation. Second, the position of the control panels can be adjusted to suit the operator's needs. The machine has even more to offer: the height-adjustable seat can be moved toward the control panel and beyond the edge of the machine on a swivel arm. On the whole,

*Wasp waist design for perfect visibility from the anti-vibration mounted operator's platform; the railing can be moved to the outside.*

the versatile range of user-specific adjustment options provide the operator with a perfect viewing level and position both when seated and when standing.

A protective canopy mounted in a fixed position relative to the operator's platform fully protects the entire operator's platform from the elements. The canopy can be extended on the left and right as needed by means of additional, independently telescoping roof elements.





# LEVEL PRO - on the road to success with a unique levelling system

## ULTRA-PRECISE MILLING RESULTS

WIRTGEN has developed an ultra-precise proprietary levelling system that includes a software programmed specifically for cold milling machines - LEVEL PRO. The overall system comprises the clearly structured LEVEL PRO panel, a controller and multiple sensors. A wide variety of different sensors, such as milling depth, cross slope or ultrasonic sensors, can be integrated into the automatic levelling system. The graphics-enabled LEVEL PRO panel provides a clear readout of key parameters. For example, the set and actual values of two active sensor signals and one passive sensor are continuously displayed on the screens as work progresses. An additional milling depth indicator on the screen - showing the difference between scraper blade and side plate positions - enables convenient monitoring of the actual milling depth. In addition, the memory feature is extremely useful to pre-programme, store and retrieve set values.



### LEVEL PRO SCREEN

Automatic ON/OFF

Settings

Switchover button

Set value

Set value UP/DOWN

Actual value

Calibration

Controller output

Cylinder UP/DOWN

Memory 1

Memory 2



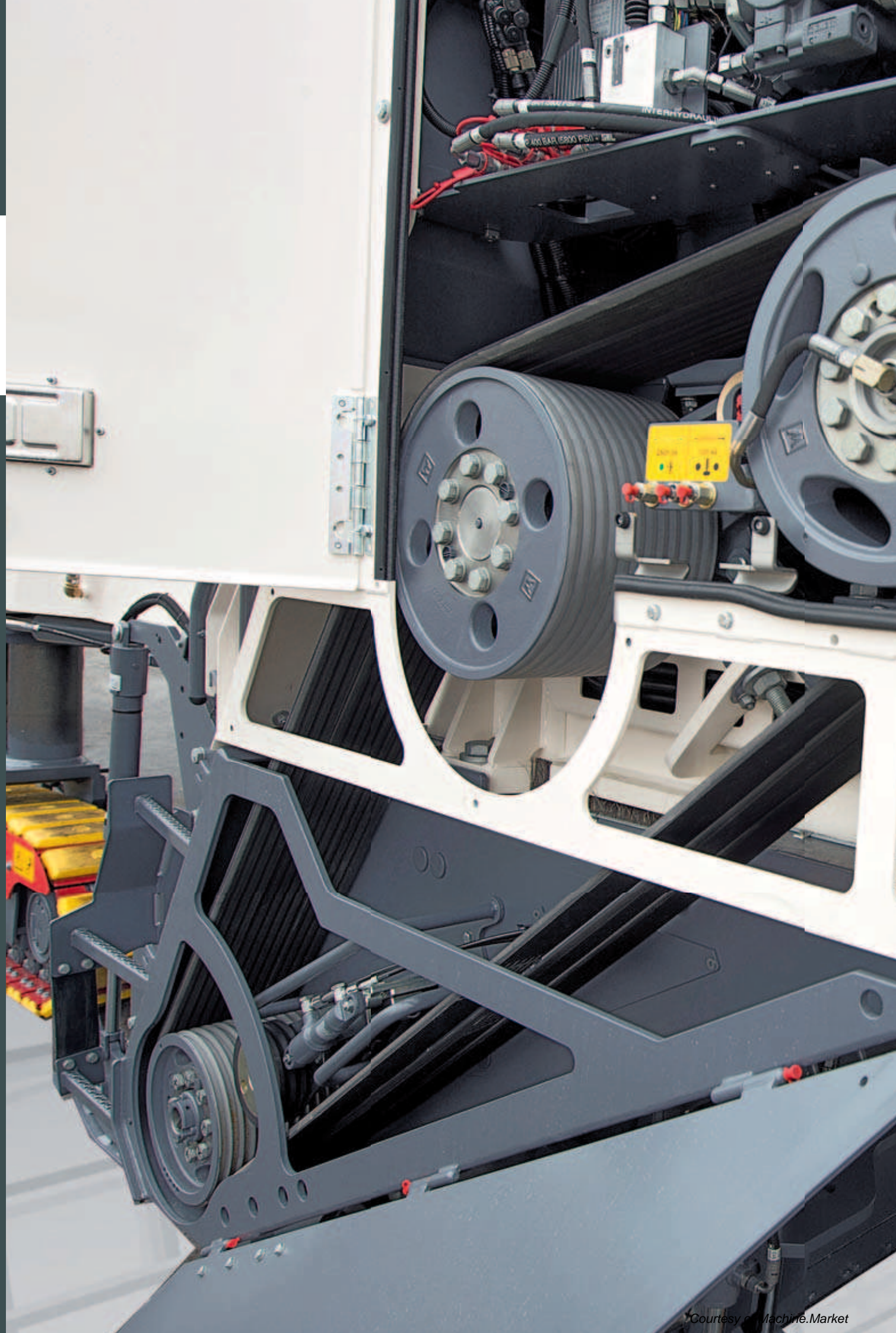



Tremendous performance meets  
tremendous efficiency.

THE W 200/W 200i HAS BEEN PROVIDED WITH AN ENGINE FEATURING STATE-OF-THE-ART TECHNOLOGIES. IMPRESSIVE EFFECT: HIGH PERFORMANCE AND OPTIMUM TORQUE AT LOW FUEL CONSUMPTION RATES. VITAL INGREDIENT OF AN ECONOMICAL AND ENVIRONMENTALLY FRIENDLY COLD MILLING MACHINE.

# Performing the toughest jobs – saving on fuel

## W 200 (US TIER 3) - HIGH-PERFORMANCE ENGINE TECHNOLOGY

The engine technology used in the W 200 cold milling machine complies with the emission standards of EC Stage/US Tier 3. The W 200 is equipped with a powerful, economical ECO diesel engine.

The fully electronic WIDRIVE machine management system enables the engine of the W 200 to always work in the optimal performance and torque ranges, at extremely low fuel consumption rates and low operating costs.

## W 200i (US TIER 4 FINAL) - OPTIMIZED ENVIRONMENTAL PROTECTION

The W 200i features state-of-the-art engine technology for lowest environmental emission levels, complying with the stringent specifications of exhaust emission standards EC Stage 4/US Tier 4f.

To ensure effective exhaust gas purification, the engine installed in the W 200i is fitted with both a combined two-way catalytic converter and diesel particulate filter as well as an SCR catalytic converter. The WIDRIVE machine management system guarantees consistently high performance levels even under full load. Operating costs of the W 200i are reduced further by the machine's intelligent diesel engine control.



## W 200 ENGINE CHARACTERISTICS:

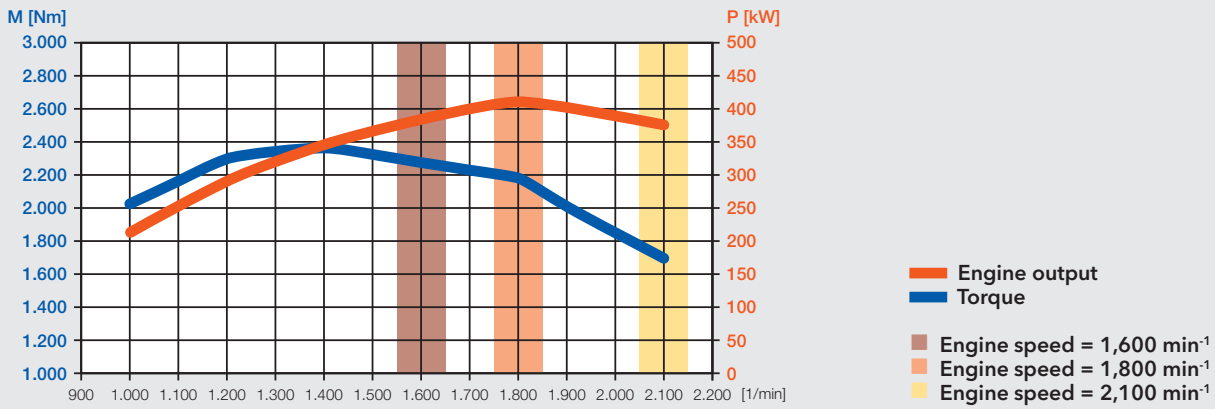

## W 200i ENGINE CHARACTERISTICS:

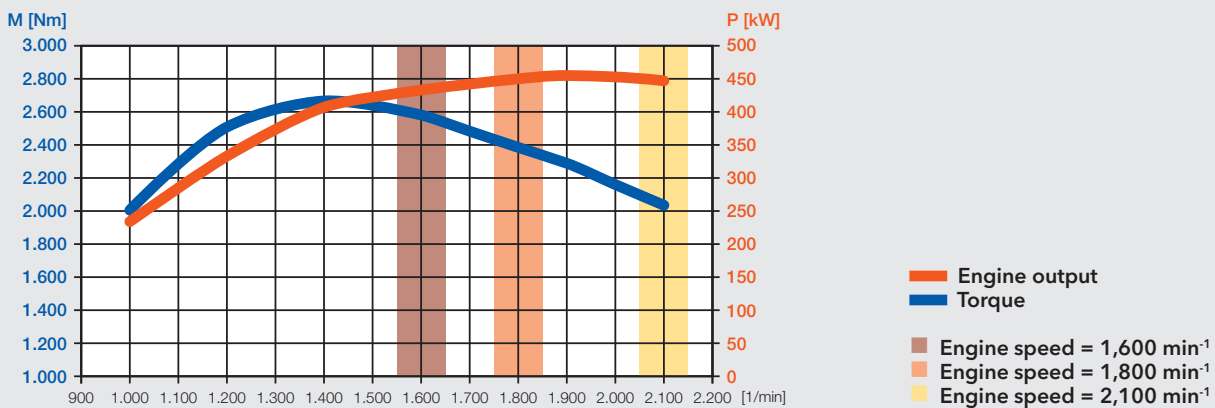

# So powerful - yet extremely economical

## THE EFFICIENT MECHANICAL MILLING DRUM DRIVE

The W 200/W 200i has been equipped with a tried-and-tested drive design: the mechanical milling drum drive which efficiently translates the engine power into high daily production rates. An automatic belt tensioner ensures consistent power transmission at all times. The multiple V-belts absorb peak loads. The intelligent drive design offers striking benefits, such as low fuel consumption, high wear resistance and ease of maintenance.







# Tremendous manoeuvrability.

QUICK TURNING MANOEUVRES IN RESTRICTED SPACE CONDITIONS. SMALL MILLING RADII. MILLING AND MANOEUVRING ON DIFFICULT GROUND. EVERYDAY ROUTINE ON THE MILLING SITE. TRIED-AND-TESTED WIRTGEN TECHNOLOGIES PUT YOUR COMMANDS INTO ACTION IMMEDIATELY. ADD TO THIS AN ALL-TRACK STEERING SYSTEM DESIGNED WITH HIGH TRACTION IN MIND. THE W 200 / W 200i CARRIES IT OFF QUICKLY WITH SOLUTIONS GEARED TO FIELD REQUIREMENTS.



*An inner radius of 2,150 mm is possible at a working width of 2.0 m.*

## ISC – gaining ground quickly

### OUTSTANDING MOBILITY

The compact W 200/W 200i owes its outstanding manoeuvrability to a hydraulic all-track steering system, a choice of different steering modes, track units offering separate hydraulic height adjustment and continuously adjustable travel speed.

*Crab steering permits the machine to easily approach the milled cut from the side.*



Add to this the ISC (Intelligent Speed Control) traction drive system. It includes three basic features: electronic traction control to ensure optimum traction, automatic speed adjustment of the individual track units in bends to reduce track pad wear, as well as an optimized advance rate paired with optimum engine performance. For perfect milling results, the steering angles of the machine's front and rear axles are coordinated, and the rear axle is tracked automatically.



# PTS - intelligent machines will drive the future

## AUTOMATIC CHASSIS ALIGNMENT PARALLEL TO THE PAVEMENT

The proprietary PTS system not only guarantees that the working depth is maintained with maximum accuracy but also makes work as easy as possible for the operator. PTS is short for "Parallel To Surface", meaning that the system automatically aligns the machine parallel to the road surface in a dynamic process: the front and rear track units are lowered evenly and parallel to each other. In addition, the fourfold full-floating axle that forms part of the PTS system quickly levels out any irregularities on the left or right side. The lifting columns are interlinked hydraulically so that any surface irregularities are levelled out by all four lifting columns.

Overall, the operator is relieved from a significant part of his workload previously generated by the need for manual adjustments. The machine adheres to a course parallel to the road surface in both milling and transport mode.

*The cold milling machine aligns parallel to the pavement surface automatically.*

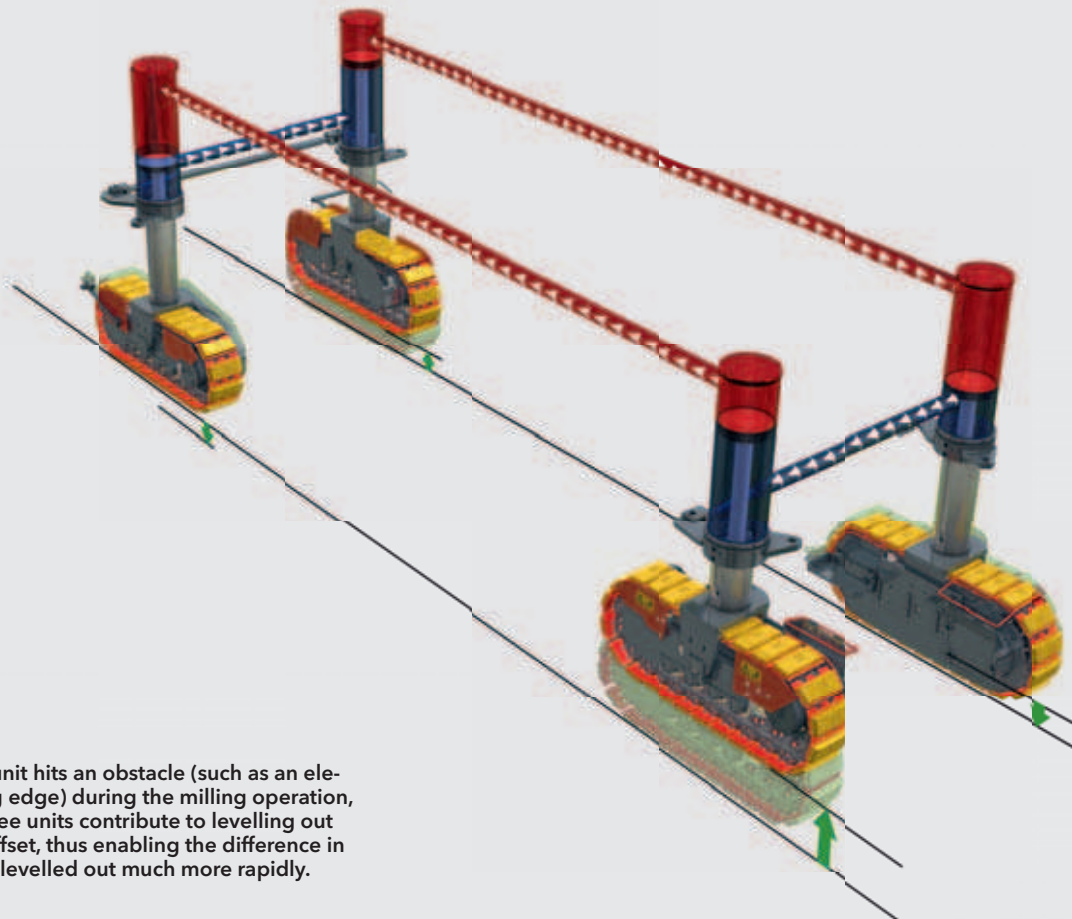

If one track unit hits an obstacle (such as an elevated milling edge) during the milling operation, the other three units contribute to levelling out the height offset, thus enabling the difference in height to be levelled out much more rapidly.





# Cutting technology

## from the market leader.

POWER OF INNOVATION IS NEEDED TO CREATE HIGH-TECH. THAT IS WHY WE AT WIRTGEN RELY ON COMPONENTS SETTING THE BENCHMARK HIGH. THE MILLING DRUM UNIT IS ONE OF THEM. IT COMBINES A WEALTH OF EXPERTISE GAINED OVER MANY DECADES WITH FORWARD-THINKING TECHNOLOGIES. RELIABLE, ROBUST, HARD-WEARING. DON'T EXPECT LESS THAN THAT.

# HT22 - a real time and cost saver

## HEAVY-DUTY QUICK-CHANGE TOOLHOLDER SYSTEM FOR THE PROS

*The electrohydraulically operated tool extractor improves the machine's overall productivity.*

The patented HT22 quick-change toolholder system has been designed for demanding everyday use on the job site. Its many advantages include a long service life, optimum tool rotation and easy tool replacement.

The replacement of tools is facilitated by the automatic drum turning device as the milling drum can be effortlessly moved into the position best suited to the operator's needs.

In addition to that, the extra-robust design of the HT22 quickchange toolholder system offers significantly extended servicing intervals.

Last but not least, there is a choice of various tool driving and extraction systems: both the manual and pneumatic extractors have proven their worth - hydraulic extractors can be used to extract cutting tools effortlessly when the diesel engine is switched off.



### HT22 QUICK-CHANGE TOOLHOLDER SYSTEM IN DETAIL

- 1 | Extremely large maximum wear distance
- 2 | Wear markers at 5 mm intervals
- 3 | High wear volume
- 4 | Optimized shank angle geometry for high component strength
- 5 | Large shank cross-section for significantly higher fracture strength
- 6 | Protective plug prevents soiling of bolt head
- 7 | Heavy-duty retaining bolt
- 8 | Seal between upper part and bottom part to allow simple insertion/removal of upper part
- 9 | Upper part covers bottom part completely for full protection of bottom part
- 10 | Extra large contact surface between upper part and bottom part for extended bottom part life
- 11 | Optimized welded connection offering increased strength and simultaneous flexibility for optimum tool rotation

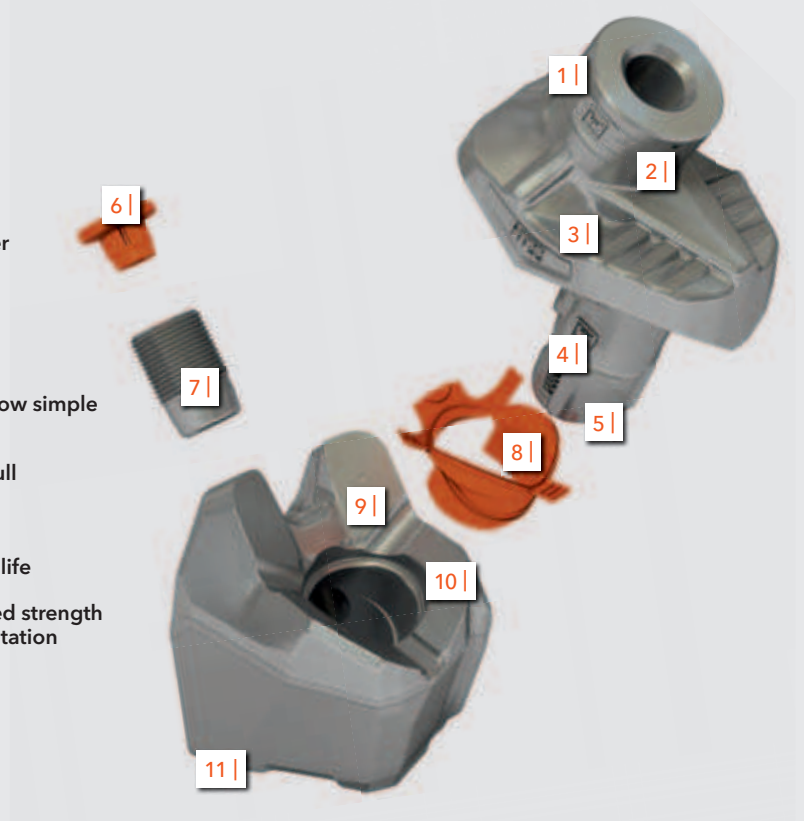

Dimensions in mm:

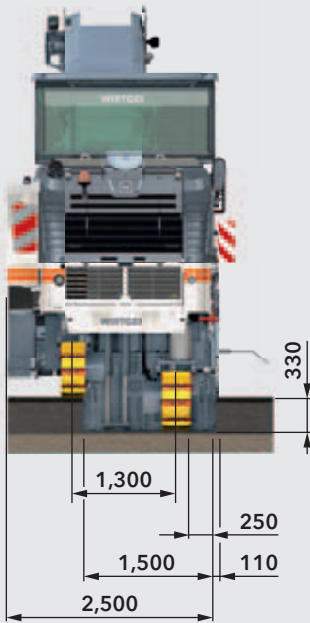

W 200/W 200i with 1.5-m drum assembly

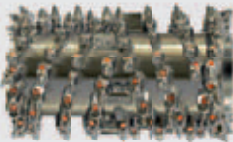

Standard milling drum  
 Milling width: 1,500 mm  
 Milling depth: 0 - 310 mm  
 Tool spacing: 15 mm

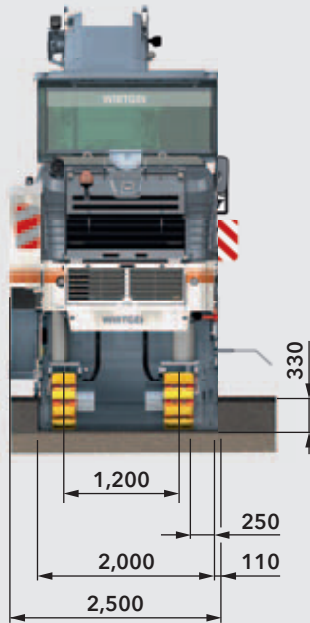

W 200/W 200i with 2.0-m drum assembly



Standard milling drum  
 Milling width: 2,000 mm  
 Milling depth: 0 - 330 mm  
 Tool spacing: 15 mm

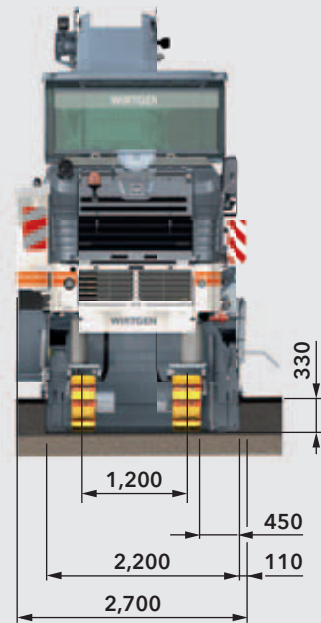

W 200/W 200i with 2.2-m drum assembly



Standard milling drum  
 Milling width: 2,200 mm  
 Milling depth: 0 - 330 mm  
 Tool spacing: 15 mm

# Milling drum assemblies 1.5 m, 2.0 m and 2.2 m wide

## DIFFERENT WORKING WIDTHS

The W 200/W 200i comes with a 2.0-m milling drum assembly in the standard package while 1.5-m or 2.2-m wide drum assemblies are available as equipment options. At a working width of 2.2 m, a 4.35 m wide road surface (first lane and median strip) is milled off in two passes.

The 2.0-m and 2.2-m milling drum assemblies are suitable for use with FCS Light so that milling drums of identical width can be changed quickly and easily.



# FCS Light – change milling drums of equal working width

## FCS LIGHT FOR MILLING WIDTHS OF 2.0 M AND 2.2 M

FCS Light is available for milling widths of 2.0 m and 2.2 m, turning the W 200/W 200i into a real multi-purpose machine. For FCS Light enables milling drums of equal width but with different tool spacings to be changed quite easily in no more than 1.5 hours by well trained staff. The procedure is facilitated by a mounting carriage offered as an equipment option.

FCS Light creates the foundation for the economical use of the W 200/W 200i in a wide range of applications, such as removing asphalt pavements at full depth, milling off surface courses or pavement irregularities. The resulting high degree of utilization of the W 200/W 200i large milling machine is a welcome side effect.

## DIFFERENT TYPES OF MILLING DRUMS

The ECO cutters equipped with a reduced number of point-attack tools ensure the highest possible area performance.

Standard milling drums are ideally suited for the removal of one or more pavement layers, ensuring a good interlock between the milled surface and the new pavement.

Fine milling drums create finely textured surfaces ideally suited as a base for the application of thin pavement layers. Micro-fine milling drums can be used to roughen road pavements and to improve their evenness and skid resistance.



**ECO Cutter**  
Milling width: 2,000 mm  
Milling depth: 0–330 mm  
Tool spacing: 25 mm



**ECO Cutter**  
Milling width: 2,200 mm  
Milling depth: 0–330 mm  
Tool spacing: 25 mm

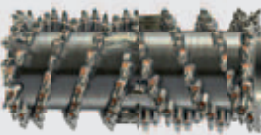

**Standard milling drum**  
Milling width: 2,000 mm  
Milling depth: 0–330 mm  
Tool spacing: 15 mm



**Standard milling drum**  
Milling width: 2,200 mm  
Milling depth: 0–330 mm  
Tool spacing: 15 mm

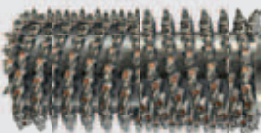

**Fine milling drum**  
Milling width: 2,000 mm  
Milling depth: 0–100 mm  
Tool spacing: 8 mm



**Fine milling drum**  
Milling width: 2,200 mm  
Milling depth: 0–100 mm  
Tool spacing: 8 mm



**Micro-fine milling drum**  
Milling width: 2,000 mm  
Milling depth: 0–30 mm  
Tool spacing: 6 x 2 mm



**Micro-fine milling drum**  
Milling width: 2,200 mm  
Milling depth: 0–30 mm  
Tool spacing: 6 x 2 mm



# Ensuring a perfect start of the milling operation

32  
33



*Operator intervention not required.*

## FULL MILLING POWER RIGHT FROM THE START

The innovative automatic system initiating the milling process enables the machine to mill at the maximum depth of 330 mm right from the very first metre.

When the automatic levelling system is activated, the machine is lowered automatically at maximum speed together with the rotating milling drum. Once the side plates reach the ground, the lifting columns continue lowering in slow mode; the lowering rate is adjusted further in the milled cut if required.

The machine retains its parallel alignment - no time is wasted on complex manual lowering processes.

## THE FRONT AND REAR TRACK UNITS ARE LOWERED TO THE SET MILLING DEPTH QUICKLY IN A PARALLEL MOVEMENT

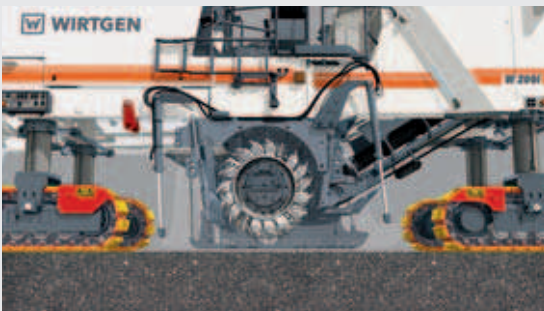

1 | The milling machine in transport position

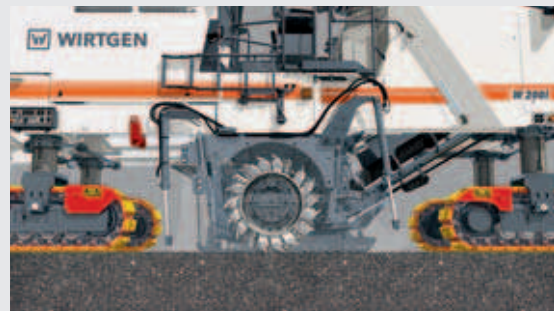

2 | The milling machine is lowered quickly while retaining its parallel alignment



3 | The milling machine is lowered slowly while retaining its parallel alignment



4 | The milling machine mills at full working depth right from the first metre





# Milling drum assembly with lots of practical features

## AUTOMATED SOLUTIONS

The milling drum assembly of the W 200/ W 200i is packed with a wide range of technical solutions. The scraper blade can be moved hydraulically. It can additionally be swung open and has an automatic locking function. The hydraulically height-adjustable side plates left and right allow precise milling along road fixtures. The right-hand side plate can be raised by 450 mm. Milling flush to kerb is thus possible also at large working depths.

In transport mode, the gradation control beam, scraper blade and side plates are raised automatically together with the lifting columns in order to safely negotiate any obstacles when manoeuvring.

Last but not least, water pressure in the high-capacity water spray bar is adjusted in accordance with the load, the amount of water being continuously variable. This arrangement ensures perfect tool cooling and reduces dust generation on the construction site.

*The right-hand side plate can be raised by a total of 450 mm.*

### Dimensions in mm:







**Reliable**

**material loading.**

A COLD MILLING MACHINE IS ONLY EVER AS GOOD AS ITS LOADING SYSTEM. THE SOLUTION: A CONVEYOR DESIGN GEARED TO PERFORMANCE REQUIREMENTS. HUGE SLEWING ANGLES. HIGH, CONTINUOUSLY ADJUSTABLE BELT SPEED. ENABLING THE W 200 / W 200i TO LOAD THE RECLAIMED MATERIAL RELIABLY AND WITH MAXIMUM PRECISION. ALWAYS POWERFUL. ALWAYS PRODUCTIVE.

# Getting rid of the milled material quickly

1 | Slewing angles of 60° to both sides ensure flexibility in material loading.



2 | For quiet work at night: clearly visible "Stop" and "Go" instructions given to the truck driver.





## POWERFUL MATERIAL LOADING

The conveyor system installed in the W 200/ W 200i offers an extremely high loading capacity and drive power to ensure quick and reliable material loading. The conveyor system is equipped with continuously adjustable belt speed control. This feature enables even giant five-axle semitrailers to be loaded to full capacity.

Conveyor slewing angles of 60° to both sides ensure a perfect loading pattern even in narrow bends, roundabouts or turning bays. Extremely low-wear conveyor belts ensure maximum loading output. The gradation control beam prevents the formation of large slabs, promotes favourable particle sizes and protects the belt from being damaged.

*Continuously adjustable belt speed and discharge range.*

-  High belt speed
-  Low belt speed



# Vacuum cutting system offers a pleasant working environment

## UNOBSTRUCTED VIEW OF THE MILLING EDGE

When developing the W 200/W 200i, particular attention was paid to the well-being of the operating crew. For this reason, the cold milling machine can be fitted with the vacuum cutting system to extract fine material particles. Its principle is simple: by creating a negative pressure in the drum housing, the mix of air and water vapour is evacuated from the housing and then fed back into the stream of the milled material on the discharge conveyor via a hose system.

It goes without saying that better air quality and visibility in the working environment of the machine operator and ground crew significantly improve operator comfort and boost staff performance. Reduced contamination of components, such as the engine or air filter, results in savings in the replacement of spare parts.

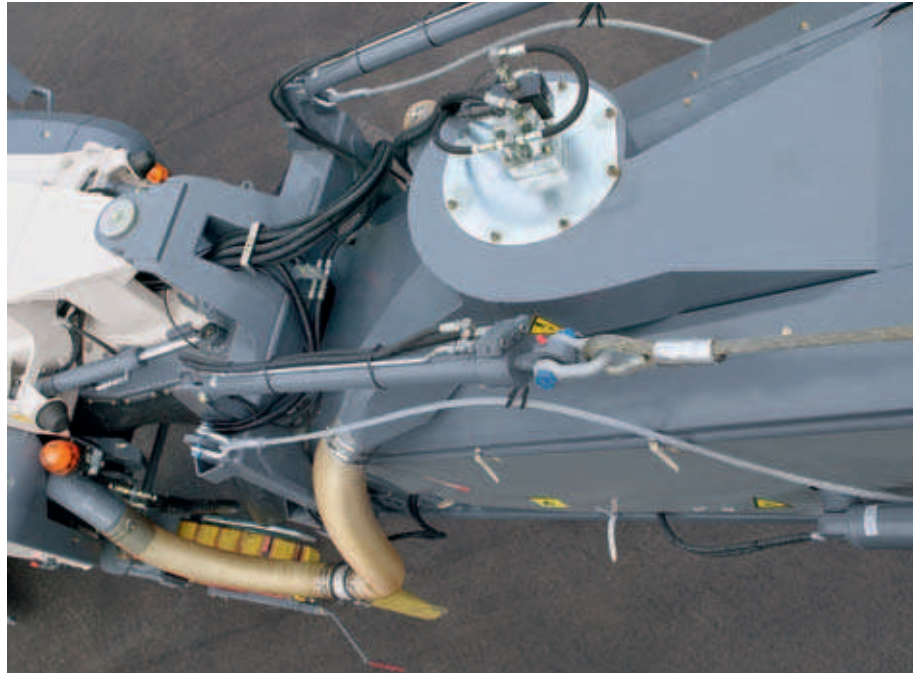

*The centrifugal fan can be adjusted in speed.*

*VCS ensures a perfect view of the milling edge regardless of the time of day or night.*

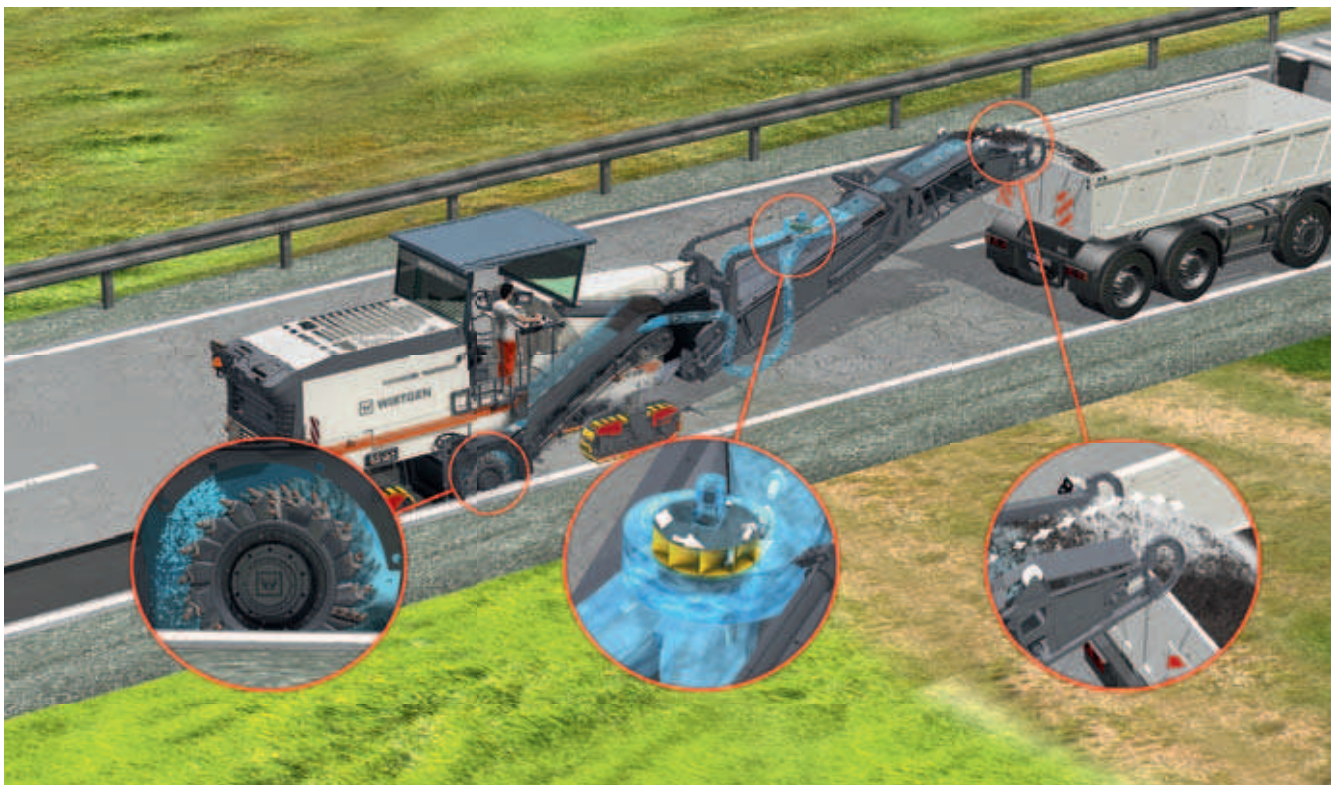





Mission: maximum

operational availability.

HEAVY-DUTY MACHINE COMPONENTS DESIGNED FOR TOUGH EVERYDAY OPERATION. EASE OF MAINTENANCE. INTELLIGENT LIGHTING SYSTEM. FAST MACHINE TRANSPORT FROM ONE JOB LOCATION TO THE NEXT. THE WIRTGEN GROUP IS PRESENT ON A GLOBAL SCALE OFFERING DEPENDABLE SERVICE SUPPORT. NOTHING IS MORE IMPORTANT TO US THAN ENSURING THE OPERATIONAL AVAILABILITY OF YOUR COLD MILLING MACHINE.



# Quick maintenance ensures high productivity

## **BEST-IN-CLASS MACHINE AVAILABILITY**

The highest possible machine availability is of crucial importance to achieve consistently high daily production rates on all kinds of milling sites. That is why the W 200/W 200i has been designed with quick and easy maintenance in mind. Opening the engine cowling at the push of a button provides direct access to the small number of intelligently arranged points of inspection and maintenance. In addition, all maintenance work is completed swiftly and easily, thus enabling the profitable

milling operation to continue as quickly as possible.

The machine's automatic on-board diagnostic system independently monitors valves, sensors and control components. Extended servicing intervals of up to 500 operating hours minimize maintenance costs.





1 | Filters, engine, hydraulic system and extraction system are readily accessible.

2 | On-board maintenance diagnostics and parameter settings via the control panel.



*A comprehensive lighting system offers excellent visibility during night operations.*

## Full utilization increases efficiency

### HIGH PERFORMANCE ALSO DURING THE NIGHT

*Night design: backlit control panels provide perfect working conditions at night.*

The amount of night work performed on road construction sites is increasing continuously. The W 200/W 200i accounts for this trend by being equipped with a comprehensive

lighting package as a standard feature. That said, the equipment package by far exceeds the "standard". The powerful, adjustable spotlights can be attached to various points at the machine in just a few swift moves to perfectly illuminate the entire working area. After nightfall, backlit control panels provide the operator with all required details at a single glance.

Should the need arise, lighting balloons can be used for additional, extensive illumination of the construction site. Any milling job can thus be easily completed even after sunset - and the W 200/W 200i is utilized to full capacity.



# Moving on to the next job in no time

## EASE OF TRANSPORT

Transport of the W 200/W 200i is easy, making sure that the machine is ready for operation again quickly on the next job location. The conveyor in folding design reduces the machine's overall transport length and permits the use of smaller transport vehicles.

The canopy can be lowered hydraulically for transport. The machine's low empty weight, combined with supplementary weights that can be mounted or removed as required, enable the W 200/W 200i to be transported on vehicles with a lower maximum permissible payload.

Strong loading and lashing lugs enable the machine to be safely lashed down on a trailer or loaded by crane. Our range of optional equipment features includes conveyor support legs for machine transport on a flatbed truck.

1 | *The folding conveyor reduces the machine's transport length.*

2 | *Transport on a flatbed truck with the canopy folded down - tailored to accurate fit!*





IT IS MORE IMPORTANT TODAY THAN EVER BEFORE TO MINIMIZE EXHAUST, NOISE AND DUST EMISSIONS ON ROAD CONSTRUCTION SITES. THE W 200/W 200i REDUCES THE IMPACT ON THE ENVIRONMENT SIGNIFICANTLY WITH ITS INTELLIGENT WIDRIVE MACHINE MANAGEMENT SYSTEM, INNOVATIVE VCS DUST EXTRACTION SYSTEM AND ENVIRONMENTALLY FRIENDLY MACHINE TECHNOLOGY.

Protecting the environment.



# Technical specification

46  
47

	W 200	W 200i
<b>Milling drum</b>		
Milling width standard	2,000 mm	
Milling width optional 1	1,500 mm	
Milling width optional 2	2,200 mm	
Milling depth *1	0-330 mm	
Drum diameter with tools	1,020 mm	
<b>Motor</b>		
Manufacturer	CUMMINS	
Type	QSX15	QSX15
Cooling	water	
Number of cylinders	6 + 6	
Rated power at 2,100 min <sup>-1</sup>	373 kW/500 HP/507 PS	447 kW/600 HP/608 PS
Maximum power	at 1,800 min <sup>-1</sup> : 410 kW/550 HP/558 PS	at 1,900 min <sup>-1</sup> : 455 kW/610 HP/619 PS
Operating power at 1,600 min <sup>-1</sup>	380 kW/510 HP/517 PS	433 kW/581 HP/589 PS
Displacement	15 l	15 l
Fuel consumption at rated power	99 l/h	118 l/h
Fuel consumption in field mix	40 l/h	47 l/h
Emission standards	EC Stage 3a/US Tier 3	EC Stage 4/US Tier 4f
<b>Electrical system</b>		
Electrical power supply	24 V	
<b>Tank capacities</b>		
Fuel tank	1,220 l	1,120 l
AdBlue®/DEF tank	-	100 l
Hydraulic oil tank	200 l	
Water tank	3,350 l	
<b>Driving properties</b>		
Max. travel and milling speed	0 to 85 m/min (5 km/h)	
<b>Crawler units</b>		
Crawler units, front and rear (L x W x H)	1,630 x 260 x 590 mm	
<b>Loading of the milled material</b>		
Belt width of primary conveyor	850 mm	
Belt width of discharge conveyor	850 mm	
Theoretical capacity of discharge conveyor	375 m <sup>3</sup> /h	

\*1 = The maximum milling depth may deviate from the value indicated due to tolerances and wear.

	W 200	W 200i
<b>Weight of base machine</b>		
Empty weight of machine excluding tank contents	25,500 kg	26,000 kg
Operating weight, CE* <sup>2</sup>	27,750 kg	28,250 kg
Maximum operating weight (full tanks, full range of equipment) in FB2200	35,800 kg	36,300 kg
<b>Weights of tank contents</b>		
Water tank filling	3,350 kg	3,350 kg
Diesel tank filling (0,83 kg/l)	1,000 kg	930 kg
AdBlue® / DEF tank filling (1,1 kg/l)	-	110 kg
<b>Additional add-on weights</b>		
<b>Driver and tools</b>		
Driver		75 kg
5 cutting tool containers		125 kg
On-board tools		30 kg
<b>Optional milling drum assemblies in lieu of standard</b>		
Milling drum housing, FB1500		100 kg
Milling drum housing, FB2200		200 kg
Milling drum housing, FB2000, FCS-L		650 kg
Milling drum housing, FB2200, FCS-L		900 kg
<b>Optional milling drums in lieu of standard</b>		
Milling drum, FB1500, LA 15		-460 kg
Milling drum, FB2200, LA 15		180 kg
<b>Optional FCS milling drums in lieu of standard</b>		
Milling drum, FB2000, LA 6x2, FCS-L		960 kg
Milling drum, FB2000, LA 8, FCS-L		660 kg
Milling drum, FB2000, LA 15, FCS-L		-150 kg
Milling drum, FB2000, LA 18, FCS-L		-260 kg
Milling drum, FB2200, LA 6x2, FCS-L		1,060 kg
Milling drum, FB2200, LA 8, FCS-L		900 kg
Milling drum, FB2200, LA 15, FCS-L		0 kg
Milling drum, FB2200, LA 18, FCS-L		-30 kg
<b>Optional additional equipment</b>		
Operator's platform including comfortable seats in lieu of standard		250 kg
Canopy in lieu of standard		280 kg
Cabin in lieu of standard		600 kg
Folding conveyor in lieu of standard		520 kg
VCS - Vacuum Cutting System		150 kg
Supplementary weight 1 for flexible use		1,700 kg

\*<sup>2</sup> = Weight of machine, half-full water tank, half-full fuel tank, driver (75 kg), on-board tools, excluding optional equipment features.

# Dimensions

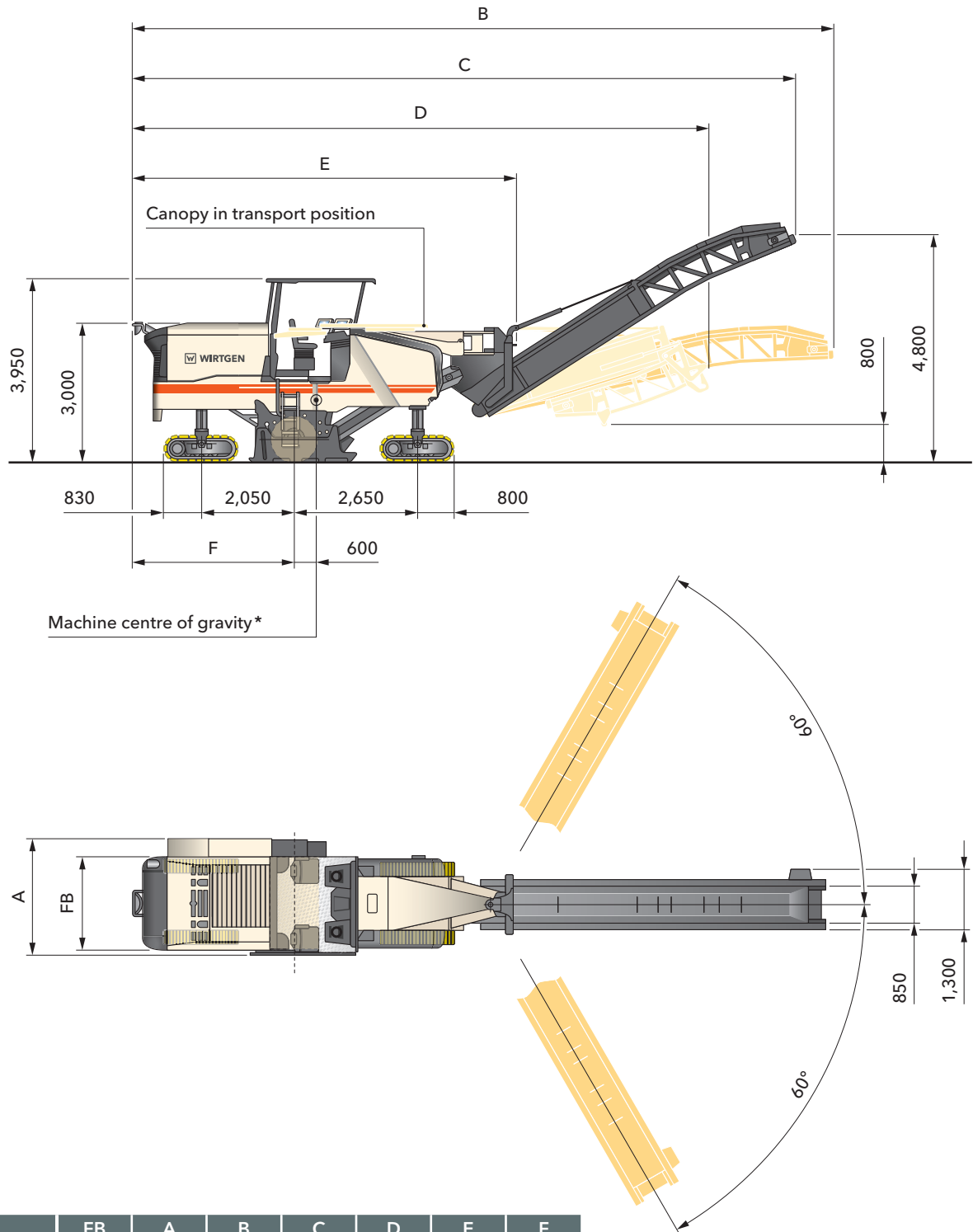

	FB	A	B	C	D	E	F
W 200	1,500	2,500					
	2,000	2,500	15,360	14,490	12,520	8,340	3,540
	2,200	2,700					
W 200i	1,500	2,500					
	2,000	2,500	15,560	14,680	12,680	8,510	3,730
	2,200	2,700					

Dimensions in mm

\*Based on operating weight, CE with conveyor folded out



Milling radius, 150 mm milling depth, dimensions in mm

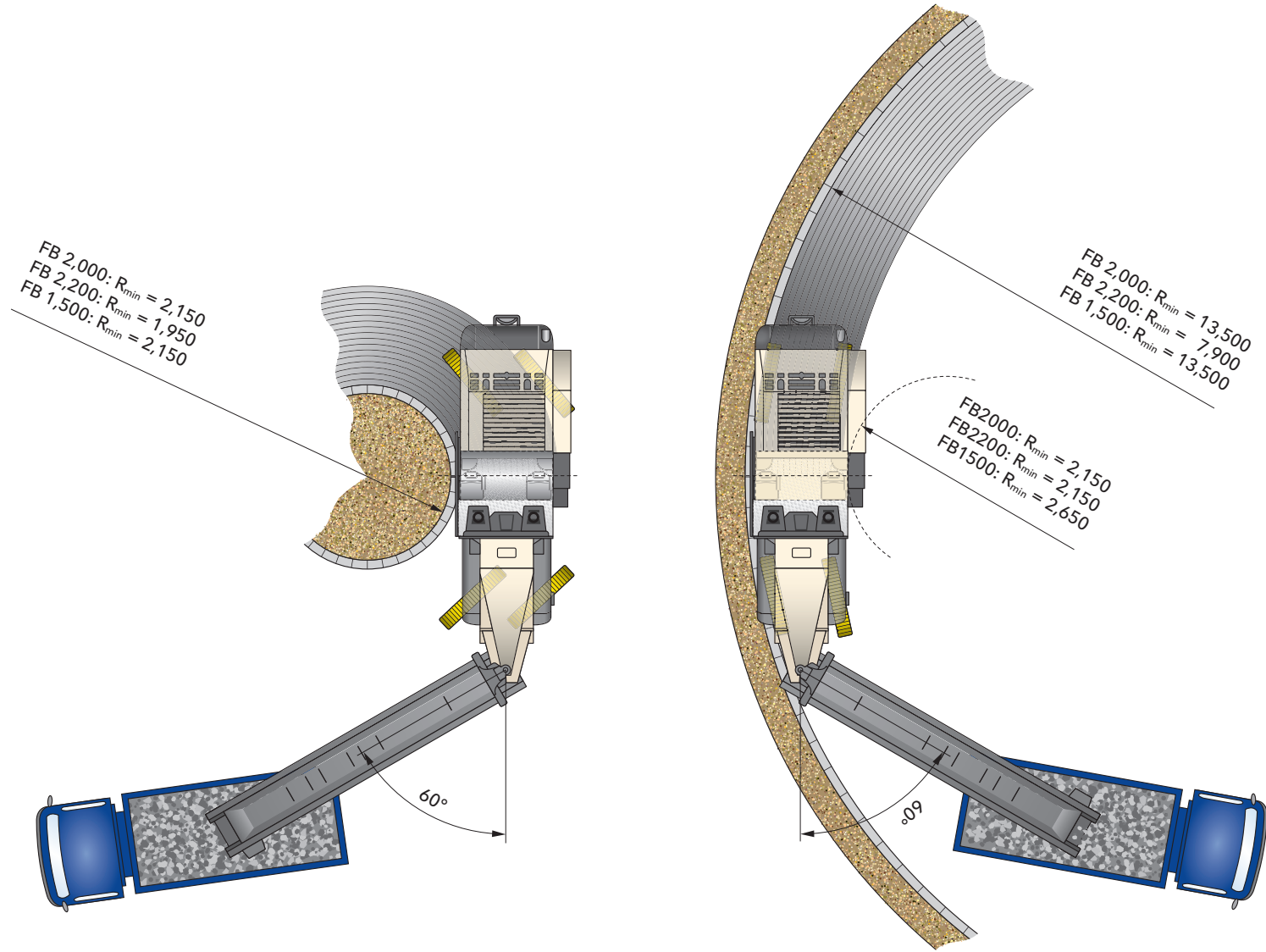

# Standard equipment

	W 200	W 200i
<b>Base machine</b>		
Basic machine with engine	■	■
Maschine chassis with double-sided wasp waist	■	■
Hydraulically opening engine cover with noise insulation	■	■
Air compressor system	■	■
Battery operated hydraulic unit for emergency functions	■	■
Cooling system with temperature-controlled fan speed	■	■
Large storage compartments for pick buckets	■	■
<b>Milling drum unit</b>		
Three milling drum rotation speeds with electric on/off function 127 r.p.m. - 109 r.p.m. - 97 r.p.m.	■	■
Hydraulic material depressor with conveyor lifting function	■	■
Hydraulically movable and positionable scraper plate with automatic locking	■	■
Hydraulically lifting side plate, right clearance 450 mm and left clearance 330 mm	■	■
Milling drum housing FB2000	□	□
<b>Milling drums</b>		
Milling drum FB2000 HT22 LA15 with 162 picks	□	□
<b>Milled-out material loading</b>		
Conveyor belt system with manually or automatically controllable transport speed	■	■
Water sprinkling system in the primary conveyor	■	■
Slewing angle discharge conveyor ± 60°	■	■
Discharge conveyor, 7,900 mm long, 850 mm wide	□	□
<b>Machine control and levelling system</b>		
Multi-function control display showing important machine operating conditions	■	■
Extensive machine diagnosis in the control display	■	■
Milling power control with automatic on/off function	■	■
Two exterior panels for operating functions by ground personnel	■	■
Milling depth regulation with LEVEL PRO levelling system, with one operating display as well as one electrical height sensor in the hydraulic cylinder right and left on side plate	■	■
Preliminary equipment for up to 7 levelling sensors on each side of the machine	—	■

- = Standard equipment
- = Standard equipment, replaceable with optional equipment
- = Optional equipment

	W 200	W 200i
<b>Operator's stand</b>		
Operator's stand with complete flexible mounting	■	■
Convenient, individually adjustable operating panel	■	■
Convenient footstep to the operator's stand, right and left	■	■
Covers for operating panels with lock	■	■
Two mirrors front, one mirror middle and one mirror in rear area of the machine	■	■
Operator's stand with single standing seats	□	□
Exterior mirror standard	□	□
<b>Under-carriage and height adjustment</b>		
PTS - machine automatically guided parallel with the road surface	■	■
ISC - intelligent track speed control with hydraulic four chain drive	■	■
High machine stability due to quadruple pendulum axle	■	■
Freely selectable steering functions for the four-track steering	■	■
Extremely wear-resistant, two-piece EPS polyurethane track pads	■	■
<b>Others</b>		
Lighting package with 3 halogen floodlights and 4 LED lights in the area of the milling unit	■	■
"Welcome" and "Go home" lights feature including LED lighting in the area of the operator's access and platform	■	■
Large tool package in lockable tool box	■	■
Total of 6 EMERGENCY STOP switches at sensible positions on the machine	■	■
Water high-pressure system with automatic on/off function, 18 bar, 67 l/min	■	■
Machine preparation for installing the control unit for WITOS FleetView. "Wirtgen Road Technologies Telematics and on-site Solutions" (WITOS) is the intelligent telematics system of the Wirtgen Road Technologies for efficient fleet and service management worldwide.	—	■
European type test certificate, GS mark and CE conformity	■	■
Water tank filling from rear of machine	□	□
Paint standard cream white RAL 9001	□	□
Halogen lighting package 24 V with rotary beacons	□	□

- = Standard equipment
- = Standard equipment, replaceable with optional equipment
- = Optional equipment

# Optional equipment

52  
53

	W 200	W 200i
<b>Milling drum unit</b>		
Milling drum housing FB2200	<input type="checkbox"/>	<input type="checkbox"/>
Milling drum housing FB1500	<input type="checkbox"/>	<input type="checkbox"/>
Milling drum housing FB2000 FCS-L	<input type="checkbox"/>	<input type="checkbox"/>
Milling drum housing FB2200 FCS-L	<input type="checkbox"/>	<input type="checkbox"/>
Milling drum housing FB1200 FCS	–	<input type="checkbox"/>
<b>Milling drums</b>		
Milling drum FB2200 HT22 LA15 with 174 picks	<input type="checkbox"/>	<input type="checkbox"/>
Milling drum FB1500 HT22 LA15 with 136 picks	<input type="checkbox"/>	<input type="checkbox"/>
Milling drum FB2000 HT22 LA15 FCS with 162 picks	<input type="checkbox"/>	<input type="checkbox"/>
Milling drum FB2000 HT22 LA18 FCS with 148 picks	<input type="checkbox"/>	<input type="checkbox"/>
Milling drum FB2200 HT22 LA15 FCS with 181 picks	<input type="checkbox"/>	<input type="checkbox"/>
Milling drum FB2200 HT22 LA18 FCS with 159 picks	<input type="checkbox"/>	<input type="checkbox"/>
Milling drum FB1200 HT22 LA15 FCS with 115 picks	–	<input type="checkbox"/>
Transport carriage for FCS milling drums from FB2000 to FB2200	<input type="checkbox"/>	<input type="checkbox"/>
Milling drum FB2000 HT22 LA8 FCS with 274 picks	<input type="checkbox"/>	<input type="checkbox"/>
Milling drum FB2000 HT22 LA25 FCS with 124 picks	<input type="checkbox"/>	<input type="checkbox"/>
Milling drum FB2000 HT5 LA6X2 FCS with 672 picks	<input type="checkbox"/>	<input type="checkbox"/>
Milling drum FB2200 HT22 LA8 FCS with 298 picks	<input type="checkbox"/>	<input type="checkbox"/>
Milling drum FB2200 HT22 LA25 FCS with 134 picks	<input type="checkbox"/>	<input type="checkbox"/>
Milling drum FB2200 HT5 LA6X2 FCS with 740 picks	<input type="checkbox"/>	<input type="checkbox"/>
Milling drum FB600 HT22 LA15 FCS with 80 picks	–	<input type="checkbox"/>
Milling drum FB900 HT22 LA15 FCS with 102 picks	–	<input type="checkbox"/>
<b>Milled-out material loading</b>		
Discharge conveyor, 7,900 mm long, 850 mm wide, with hydraulic folding device	<input type="checkbox"/>	<input type="checkbox"/>
VCS extraction system	<input type="checkbox"/>	<input type="checkbox"/>
Supporting device discharge conveyor	<input type="checkbox"/>	<input type="checkbox"/>
<b>Machine control and levelling system</b>		
Sonic Ski sensor with connection cable	<input type="checkbox"/>	<input type="checkbox"/>
Levelling boom for scanning up to 4 m to the side of the machine	<input type="checkbox"/>	<input type="checkbox"/>
Hydraulic sensor for scanning ahead of the milling drum right	<input type="checkbox"/>	<input type="checkbox"/>
Hydraulic sensor for scanning ahead of the milling drum right + left	<input type="checkbox"/>	<input type="checkbox"/>
Operating display LEVEL PRO	<input type="checkbox"/>	<input type="checkbox"/>
Multiplex preliminary equipment comprising 4 sensor sockets	<input type="checkbox"/>	<input type="checkbox"/>
Multiplex 3-way right with 2 ultrasonic sensors, including Multiplex preliminary equipment	<input type="checkbox"/>	<input type="checkbox"/>
Multiplex 3-way right + left with 4 ultrasonic sensors, including Multiplex preliminary equipment	<input type="checkbox"/>	<input type="checkbox"/>
Basic equipment laser levelling without laser transmitter	<input type="checkbox"/>	<input type="checkbox"/>

- = Standard equipment
- = Standard equipment, replaceable with optional equipment
- = Optional equipment

	W 200	W 200i
<b>Machine control and levelling system</b>		
Level control 3D levelling pre-equipment	<input type="checkbox"/>	<input type="checkbox"/>
Slope control sensor	<input type="checkbox"/>	<input type="checkbox"/>
Milling depth measurement and display in the LEVEL PRO display	<input type="checkbox"/>	<input type="checkbox"/>
<b>Operator's stand</b>		
Operator's stand with large storage compartment and single standing seats	<input type="checkbox"/>	<input type="checkbox"/>
Operator's stand with comfort seat package	<input type="checkbox"/>	<input type="checkbox"/>
Operator's stand with cabin "Operator Comfort System"	<input type="checkbox"/>	<input type="checkbox"/>
Exterior mirror folding with signal lights	<input type="checkbox"/>	<input type="checkbox"/>
Weather canopy folds in electrohydraulically	<input type="checkbox"/>	<input type="checkbox"/>
Hot air heating footwell of the operator's stand	<input type="checkbox"/>	<input type="checkbox"/>
Monitor system with 2 cameras	<input type="checkbox"/>	<input type="checkbox"/>
Monitor system with 6 cameras and additional monitor	<input type="checkbox"/>	<input type="checkbox"/>
<b>Others</b>		
Water tank filling with hydraulic filling pump	<input type="checkbox"/>	<input type="checkbox"/>
Paint in one special colour (RAL)	<input type="checkbox"/>	<input type="checkbox"/>
Paint in two special colours (RAL)	<input type="checkbox"/>	<input type="checkbox"/>
Paint in maximum two special colours with substructure in special colour (RAL)	<input type="checkbox"/>	<input type="checkbox"/>
Powerful LED lighting package 24 V with rotary beacons	<input type="checkbox"/>	<input type="checkbox"/>
Additional weight 1700 kg	<input type="checkbox"/>	<input type="checkbox"/>
Large storage compartment on rear of machine	<input type="checkbox"/>	<input type="checkbox"/>
Electric preheating of the fuel filter	–	<input type="checkbox"/>
Electrical power set 220 V 4 kW	<input type="checkbox"/>	<input type="checkbox"/>
Electrical power set 110 V 4 kW	<input type="checkbox"/>	<input type="checkbox"/>
High-pressure water cleaner, 150 bar 15 l/min	<input type="checkbox"/>	<input type="checkbox"/>
Milling drum rotation device	<input type="checkbox"/>	<input type="checkbox"/>
Hydraulic pick ejector drift	<input type="checkbox"/>	<input type="checkbox"/>
Pneumatic hammer with pick ejector/insertor	<input type="checkbox"/>	<input type="checkbox"/>
Additional seats for pick change with storage compartment	<input type="checkbox"/>	<input type="checkbox"/>
Diesel tank filling pump with 5.0 m suction hose	<input type="checkbox"/>	<input type="checkbox"/>
Illumination balloon 220 volt	<input type="checkbox"/>	<input type="checkbox"/>
Illumination balloon 110 volt	<input type="checkbox"/>	<input type="checkbox"/>
WITOS FleetView telematics system incl. 3-year operating period (EU)	–	<input type="checkbox"/>
WITOS FleetView telematics system incl. 3-year operating period (USA)	–	<input type="checkbox"/>
WITOS FleetView telematics system incl. 3-year operating period – PROMOTION	–	<input type="checkbox"/>

= Standard equipment  
 = Standard equipment, replaceable with optional equipment  
 = Optional equipment







WIRTGEN GmbH

Reinhard-Wirtgen-Str. 2 · 53578 Windhagen · Germany  
Phone: +49 (0)26 45/131-0 · Fax: +49 (0)26 45/131-392  
Internet: [www.wirtgen.com](http://www.wirtgen.com) · E-Mail: [info@wirtgen.com](mailto:info@wirtgen.com)

